



**THE DATASHEET OF  
CRM-182J/UNI BL**



# CRM-181J, CRM-182J, CRM-183J | Singlefunction time relays



EAN code	CRM-181J	CRM-182J	CRM-183J
CRM-181J/UNI ZR:	8595188180382	8595188176903	8595188180610
CRM-181J/UNI ZN:	8595188180399	8595188176910	8595188180603
CRM-181J/UNI BL:	8595188180405	8595188176927	8595188180580
CRM-181J/UNI OD:	8595188180412	8595188176934	8595188180597

Technical parameters	CRM-181J	CRM-182J	CRM-183J
<b>Power supply</b>			
Supply terminals:	A1 - A2		
Voltage range:	AC/DC 12 - 240 V (AC 50-60 Hz)		
Power input (max.):	2 VA/1.5 W	2.5 VA/1.5 W	2.5 VA/1.5 W
Supply voltage tolerance:	-15 %; +10 %		
Supply indication:	green LED		
<b>Time circuit</b>			
Time ranges:	0.1 s - 100 h		
Time setting:	rotary switch and potentiometer		
Time deviation:	5 % - mechanical setting		
Repeat accuracy:	0.2 % - set value stability		
Temperature coefficient:	0.01%/°C, at = 20 °C (0.01 %/°F, at = 68°F)		
<b>Output</b>			
Output contact 1:	1x changeover/SPDT (AgNi)		
Current rating:	16 A/AC1; 1 HP 240 Vac, 1/2 HP 120 Vac; PD. B300		
Breaking capacity:	4000 VA/AC1, 384 W/DC1		
Electrical life (AC1):	100.000 ops.		
Output contact 2 (3):	x	1x chang./SPDT (AgNi)	2x chang./DPDT (AgNi)
Current rating:	x	16 A/AC1; 1 HP 240 Vac, 1/2 HP 120 Vac; PD. B300	8 A/AC1; 1/2 HP 240Vac; PD. B300
Breaking capacity:	x	4000 VA/AC1, 384 W/DC1	2000 VA/AC1, 192 W/DC1
Electrical life (AC1):	x	100.000 ops.	50.000 ops.
Switching voltage:	250 V AC/24 V DC		
Max. power dissipation:	1.2 W	2.4 W	2.4 W
Mechanical life:	10.000.000 ops.		
<b>Control</b>			
Control terminals:	A1-S		
Load between S-A2:	Yes		
Impulse length:	min. 25 ms/max. unlimited		
Reset time:	max. 150 ms		
<b>Other information</b>			
Operating temperature:	-20 .. +55 °C (-4 .. 131 °F)		
Storage temperature:	-30 .. +70 °C (-22 .. 158 °F)		
<b>Dielectric strength:</b>			
supply - output 1	4 kV AC		
supply - output 2 (3)	x	4 kV AC	1 kV AC
output 1 - output 2	x	4 kV AC	1 kV AC
output 2 - output 3	x	x	1 kV AC
Operating position:	any		
Mounting:	DIN rail EN 60715		
Protection degree:	IP40 front panel/IP20 terminals		
Overvoltage category:	III.		
Pollution degree:	2		
Max. cable size (mm²):	solid wire max. 1x 2.5 or 2x 1.5/ with sleeve max. 1x 2.5 (AWG 12)		
Dimensions:	90 x 17.6 x 64 mm (3.5" x 0.7" x 2.5")		
Weight:	61 g (2.2 oz)	84 g (3 oz)	84 g (3 oz)
Standards:	EN 61812-1		

- Single function time relays are suitable for applications where there is a clear function requirement in advance and are suitable for universal use in automation, control and regulation or in house installations.
- Choice of four types: ZR, ZN, BL, OD.
- All functions initiated by the supply voltage can use the control input to inhibit the ongoing delay (pause).
- Multifunction red LED flashes or shines depending on the operating status.

## Description

CRM-183J

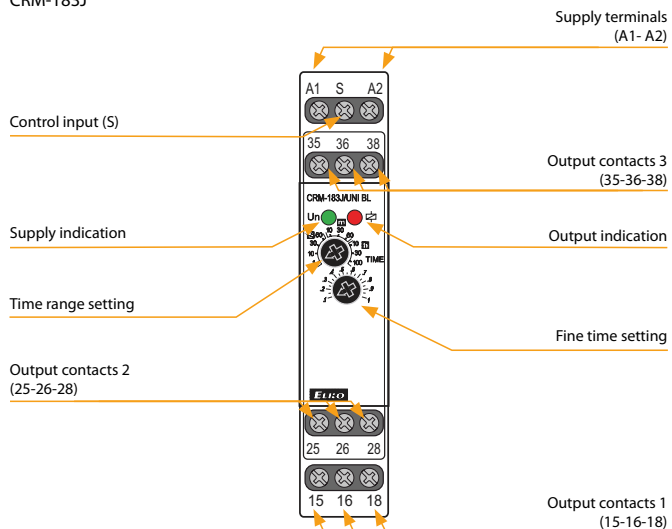

## Connection

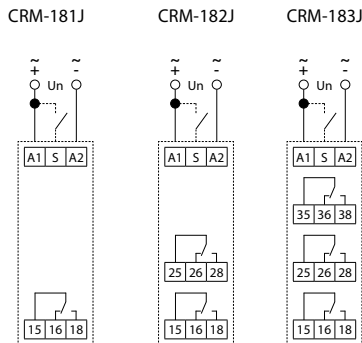

**CRM-183J:**  
The potential difference between the supply terminals (A1-A2), output contact 2 (25-26-28) and output contact 3 (35-36-38) must be a maximum of 250 V AC rms/DC.

## Possibility to connect load onto controlling input

It is possible to connect the load (e.g.: contactor) between terminals S-A2, without any interruption of correct relay function.

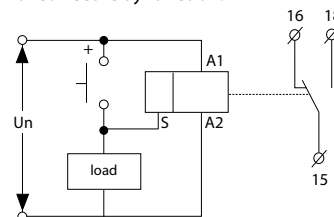

## Indication of operating states

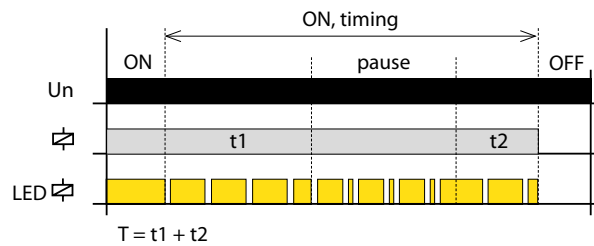
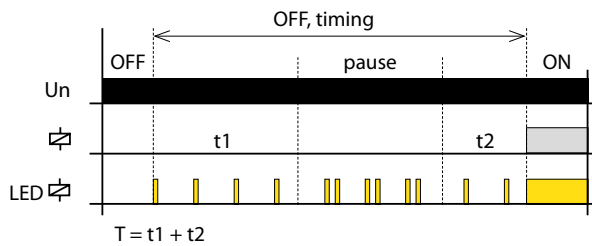

## Function

### ZR: ON DELAY

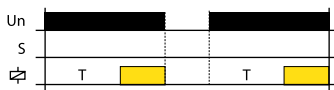

When the supply voltage is applied, the time delay  $T$  begins. When the timing is complete, the relay closes and this condition continues until the supply voltage is disconnected.

### BL: FLASHER - ON first

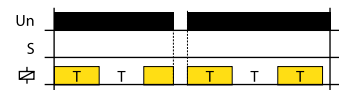

If the control contact is closed and the supply voltage is connected, the relay will close and the timing will start only after the control contact has been opened. When the timing is complete, the relay opens.

### ON DELAY with Inhibit

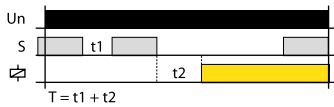

If the control contact is closed and the supply voltage is connected, the relay is opened and timing does not start until the control contact opens. When the timing is complete, the relay closes. If the control contact is closed during timing, the timing is interrupted and continues only after the control contact opens.

### FLASHER - ON first with Inhibit

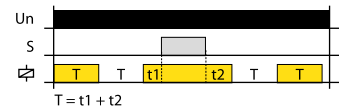

If the control contact is closed during an active timer setting, the timing is interrupted and continues only after the control contact opens again.

### ZN: INTERVAL ON



After supply voltage relay closes and starts the delay time  $T$ . After the end of the timing relay opens and this state lasts until the supply voltage is disconnected.

### OD: OFF DELAY



When the supply voltage is applied, the relay is open. When the control contact is closed, the relay closes. When the control contact opens, the time delay  $T$  begins. If the control contact is closed during timing, the time is reset and the relay remains closed. When the control contact opens, the time delay  $T$  starts again and opens when the relay closes.

### INTERVAL ON with Inhibit

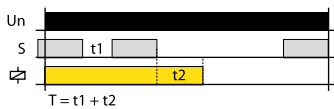

If the control contact is closed and the supply voltage is connected, the relay will close and the timing will start only after the control contact has been opened. When the timing is complete, the relay opens. If the control contact is closed during timing, the timing is interrupted and continues only after the control contact opens.

#### Note:

ZR, ZN and BL functions are initiated by connecting the supply voltage to the product, i.e. In the event of a failure and recovery of the supply voltage, the relay automatically performs 1 cycle.

## Looking for pricing, stock, or lifecycle information?

Click below to explore more details on WIN SOURCE:

-  [View CRM-182J/UNI BL on WIN SOURCE](#)
-  [ELKO EP North America LLC Information](#)

## Optimize Your Supply Chain with WIN SOURCE Solutions

-  Global Sourcing Solution
-  Obsolete Management
-  Cost Control Management
-  Shortage Management
-  Alternative Solution
-  Excess Inventory Management