



EAN code			
TC-0: 8595188110075	TZ-0: 8595188140591	Pt100-3: 8595188136136	
TC-3: 8595188110617	TZ-3: 8595188110600	Pt100-6: 8595188136143	
TC-6: 8595188110082	TZ-6: 8595188110594	Pt100-12: 8595188136150	
TC-12: 8595188110099	TZ-12: 8595188110587		

Technical parameters	TC	TZ	Pt100
Range:	-20 to +80 °C	-40°C to +125°C	-30°C to +200°C
Scanning element:	NTC 12K	NTC 12K	Pt100
Tolerance:	±(0.15°C + 0.002 t)	±(0.15°C + 0.002 t)	±(0.3°C + 0.005 t)
In air/ in water:	(τ0.5) ≤ 18 s	(τ65) 62 s / 8 s	(τ0.5) - / 7 s
In air/ in water:	(τ0.9) ≤ 48 s	(τ95) 216 s / 23 s	(τ0.9) - / 19 s
Cable material:	PVC unshielded, 2x 0.25 mm ²	PVC	shielded silicone 2 x 0.22 mm ²
Terminal material:	polyamid	stainless steel	Copper
Protection degree:	IP67	IP67	IP67
Electrical strength:	2500 VAC	2500 VAC	2500 VAC
Insulation resistance:	> 200 MΩ at 500 VDC	> 200 MΩ at 500 VDC	> 200 MΩ at 500 VDC

Types of temperature sensors:

	TC-0	TZ-0	-
- length:	100 mm	110 mm	-
- weight:	5 g	4.5 g	-
	TC-3	TZ-3	Pt100-3
- length:	3 m	3	3 m
- weight:	70 g	106 g	68 g
	TC-6	TZ-6	Pt100-6
- length:	6 m	6 m	6 m
- weight:	130 g	216 g	149 g
	TC-12	TZ-12	Pt100-12
- length:	12 m	12 m	12 m
- weight:	250 g	418 g	249 g

τ65 (95): time, which sensor needs to heat up on 65 (95) % of ambient temperature of environment, in which is located.

- Thermister temperature sensors are made of Negative Temperature Coefficient (NTC) embedded in a PVC or metal sleeve with a thermally-conductive sealer.
- **Sensor TC**
- lead-in cable to sensor TC is made of wire CYSY 2D x 0.5 mm/ 0.02".
- **Sensor TZ**
- cable VO3SS-F 2D x 0.5 mm /0.02" with silicone insulation for use in high temperature applications.
- silicone insulation for use in high temperature applications.
- **Sensor Pt100**
- shielded silicon 2x 0.22 mm² (AWG 21), shielding connected with a case.
- temperature sensors can be connected directly to the terminal block
- cable lengths can not be changed, connected or modified.

Resistive values of sensors in dependance on temperature

Temperature (°C)	Sensor NTC (kΩ)	Sensor Pt100 (Ω)
20	14.7	107.8
30	9.8	111.7
40	6.6	115.5
50	4.6	119.4
60	3.2	123.2
70	2.3	127.1

Tolerance of sensor NTC 12 kΩ is ± 5% by 25 °C/ 77°F.
Long-term resistance stability by sensor Pt100 is 0.05% (10 000 hours).

Diagramm of sensor warm up via air

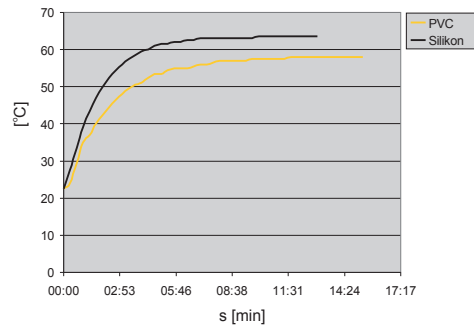

PVC -reaction to water temperature from 22.5 °C to 58°C.
Silicone - reaction to water temperature from 22.5°C to 63.5°C.

Sensor photo

TC



TZ



Pt100



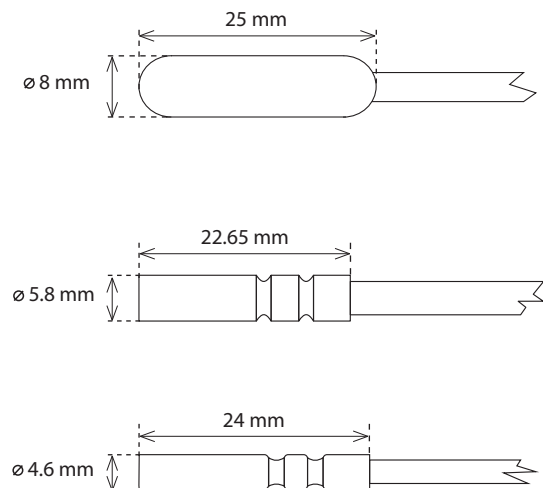

Drawing



Looking for pricing, stock, or lifecycle information?

Click below to explore more details on WIN SOURCE:

-  [View TZ-6 on WIN SOURCE](#)
-  [ELKO EP North America LLC Information](#)

Optimize Your Supply Chain with WIN SOURCE Solutions

-  Global Sourcing Solution
-  Obsolete Management
-  Cost Control Management
-  Shortage Management
-  Alternative Solution
-  Excess Inventory Management