



**5 YEAR  
WARRANTY**



EAN code  
 PRI-51/0.5A: 8595188142885  
 PRI-51/1A: 8595188124904  
 PRI-51/2A: 8595188124911  
 PRI-51/5A: 8595188124928  
 PRI-51/8A: 8595188124935  
 PRI-51/0.1-10A: 8595188155717  
 PRI-51/16A: 8595188124942

Technical parameters		PRI-51
<b>Supply circuit</b>		
Supply terminals:	A1 - A2	
Voltage range:	AC 24 - 240 V and DC 24 V (AC 50-60 Hz)	
Burden:	max. 25 VA/1.6 W	
Max. dissipated power (U <sub>n</sub> + terminals):	2.5 W	
Supply voltage tolerance:	-15 %; +10 %	
<b>Measuring circuit</b>		
Load:	between B1 - B2	
Current range:	PRI-51/0.5 A: AC 0.05-0.5 A    PRI-51/8 A: AC 0.8-8 A PRI-51/1 A: AC 0.1-1 A    PRI-51/0.1-10 A: AC 0.1-10 A PRI-51/2 A: AC 0.2-2 A    PRI-51/16 A: AC 1.6-16 A PRI-51/5 A*: AC 0.5-5 A    (AC 50-60 Hz)	
Max. permanent current:	PRI-51/0.5 A: 2 A PRI-51/1 A: 4 A PRI-51/2 A: 8 A PRI-51/0.1-10 A: 10 A PRI-51/5 A, PRI-51/8 A, PRI-51/16 A: 17 A	
Inrush overload <1ms:	50 A	
Current adjustment:	potentiometer	
Time delay:	adjustable 0.5 - 10 s	
<b>Accuracy</b>		
Setting accuracy (mechanical):	5 %	
Repeat accuracy:	< 1 %	
Temperature dependency:	< 0.1 %/°C (°F)	
Limit values tolerance:	5 % (10 % for 0.05 - 0.5 A and 0.1 - 10 A range)	
Hysteresis (fault to OK):	5 %	
Mechanical life:	60.000.000 op.	
Electrical life (AC1):	150.000 op.	
<b>Output</b>		
Number of contacts:	1x changeover/SPDT (AgNi/Silver Alloy)	
Current rating:	8 A/AC1; 1/3 HP 240 Vac, 1/4 HP 120 Vac; PD. B300	
Breaking capacity:	2000 VA/AC1, 240 W/DC	
Output indication:	red LED	
<b>Other information</b>		
Operating temperature:	-20 .. 55 °C (-4 .. 131 °F)	
Storage temperature:	-30 .. 70 °C (-22 .. 158 °F)	
Dielectrical strength:	4 kV (supply - output)	
Operating position:	any	
Mounting:	DIN rail EN 60715	
Protection degree:	IP40 from front panel/IP10 terminals	
Overvoltage category:	III.	
Pollution degree:	2	
Max. cable size (mm <sup>2</sup> ):	solid wire max. 2x 2.5 or 1x 4, with sleeve max. 1x 2.5 or 2x 1.5 (AWG 12)	
Dimensions:	90 x 17.6 x 64 mm (3.5" x 0.7" x 2.5")	
Weight:	72 g (2.5 oz.)	
Standards:	EN 60255-1, EN 60255-26, EN 60255-27	

\* applicable also for current transformer

- It serves for monitoring of heating in rail-switches, heating cables, consumption of 1-phase motors, indicates current flow.
- Flexible adjustment by potentiometer.
- Adjustable delay 0.5 - 10 s to eliminate short current peaks.
- It is possible to use for current scanning from current transformer.
- Supply is galvanically separated from measured current, it must be in the same phase.

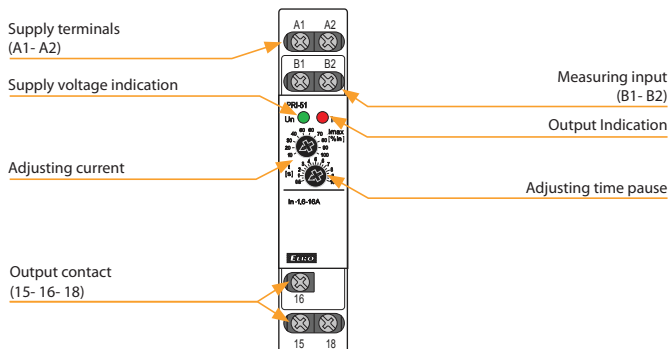
### Description



### Function

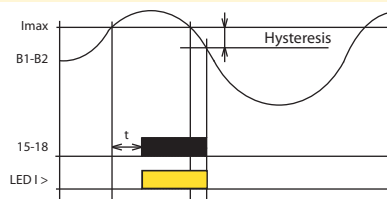

Monitoring relay PRI-51 serves to monitor current level in one-phase AC circuits. Gradual setting of actuating current of monitoring relay enables many different applications. Output relay is in normal state opened. After the set current level is reached, relay closes after the set delay (0.5 - 10 s). When returning from faulty to normal state there is a hysteresis (5 %). Multi-voltage of this relay is an advantage. It is possible to monitor load which doesn't have the same supply as monitoring relay PRI-51.

Range of PRI-51 can be increased by an external current transformer.

### Connection

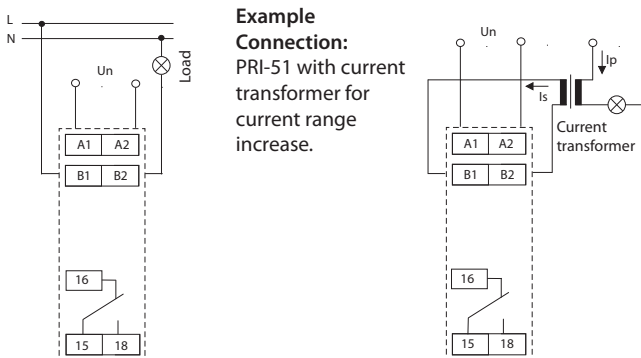

**Example Connection:** PRI-51 with current transformer for current range increase.

### Symbol

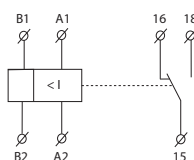



### Example of an order

Always specify all reference name of current relay according to required range, for example PRI-51/5.

## Looking for pricing, stock, or lifecycle information?

Click below to explore more details on WIN SOURCE:

-  [View PRI-51/1A on WIN SOURCE](#)
-  [ELKO EP North America LLC Information](#)

## Optimize Your Supply Chain with WIN SOURCE Solutions

-  Global Sourcing Solution
-  Obsolete Management
-  Cost Control Management
-  Shortage Management
-  Alternative Solution
-  Excess Inventory Management