



**THE DATASHEET OF  
PRI-34/5A**



# PRI-34 | Multifunction current monitoring relays in 1P - AC



EAN code  
 PRI-34/1A: 8595188188968  
 PRI-34/2A: 8595188182829  
 PRI-34/5A: 8595188182836  
 PRI-34/8A: 8595188188975  
 PRI-34/16A: 8595188182843

## Technical parameters PRI-34

### Supply

Supply terminals:	A1 – A2
Supply voltage:	AC/DC 24 – 240 V (AC 50-60 Hz)
Consumption (max.):	3.8 VA/0.7 W
Supply voltage tolerance:	-15 %; +10 %

### Measuring circuit

Current range:	PRI-34/1A   In - 1A PRI-34/2A   In - 2A PRI-34/5A   In - 5A PRI-34/8A   In - 8A PRI-34/16A   In - 16A (AC 50-60 Hz)
Max. permanent current   peak overload (1 s):	PRI-34/1A   2A/10A PRI-34/2A   4A/10A PRI-34/5A   10A/16A PRI-34/8A   16A/16A PRI-34/16A   17A/32A
Upper level setting (Imax):	10 – 100 %In
Lower level setting (Imin):	5 – 95 %In
Time delay (d):	300 ms
Time delay (t):	adjustable, 0.5 – 10 s

### Accuracy

Setting accuracy (mech.):	5 %
Repeat accuracy:	< 1 %
Temperature dependency:	< 0.1 %/°C
Limit values tolerance:	5 %
Hysteresis (fault to OK):	5 % (function O1, U1, W) Imax – Imin (function O2, U2)

### Output

Contact type:	1x changeover (AgNi)
Current rating:	13 A/AC1; 1 HP 240 Vac, 1/2 HP 120 Vac; PD. B300
Breaking capacity:	4000 VA/AC1, 384 W/DC1
Switching voltage:	250 V AC/24 V DC
Power dissipation (max.):	1.2 W
Mechanical life:	10.000.000 ops.
Electrical life (AC1):	100.000 ops.

### Other information

Operating temperature:	-20 .. +55 °C (-4 .. 131 °F)
Storage temperature:	-30 .. +70 °C (-22 .. 158 °F)
Dielectric strength:	AC 4 kV (supply – output)
Operating position:	any
Mounting:	DIN rail EN 60715
Protection degree:	IP40 front panel / IP20 terminals
Overvoltage category:	III.
Pollution degree:	2
Cross-wire section – solid/stranded with ferrule (mm²):	max. 1x 2.5, 2x 1.5/ max. 1x 2.5 (AWG 14)
Dimensions:	90 x 17.6 x 64 mm (3.5" x 0.7" x 2.5")
Weight:	60 g (2.15 oz)
Standards:	EN 60255-1, EN 60255-26, EN 60255-27

- It is used to monitor the value of alternating current, e.g.: motors, heating cables, lamps and other devices.
- Power supply and monitoring circuits are not galvanically isolated.
- Monitors current exceeding the upper current level (Imax) and falling below the lower current level (Imin) – according to the selected function.
- Smooth adjustment of both current levels.
- Adjustable time delay (to eliminate short-term current drops and spikes).
- Option to select functions with fault state memory (Latch).
- Measures true root mean square value of the current - TRUE RMS.
- Possibility to extend the current range using an external current transformer.

## Description

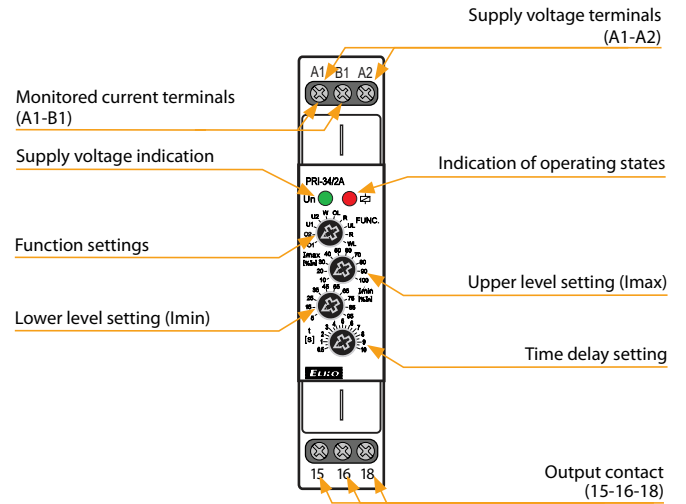

## Connection

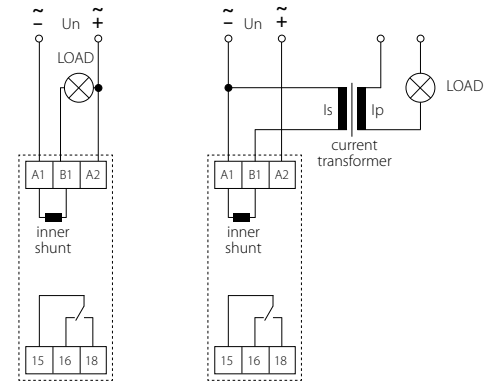

## Indication of operating states

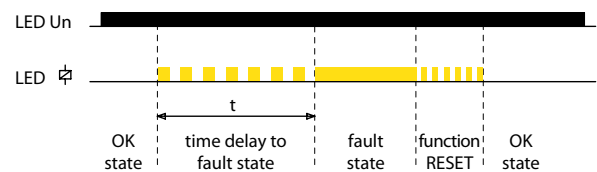

## Function

**O1 OVER (hysteresis 5%)**

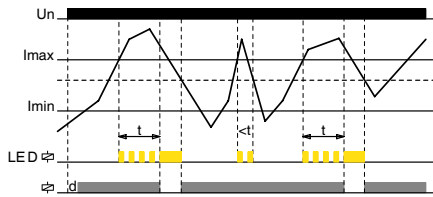

**U1 UNDER (hysteresis 5%)**

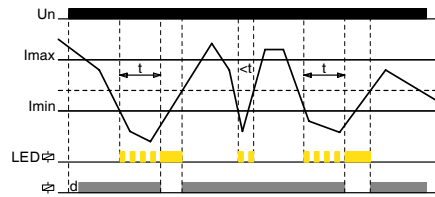

**W WINDOW (hysteresis 5%)**

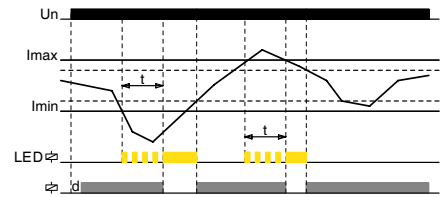

**O2 OVER (hysteresis to  $I_{min}$ )**

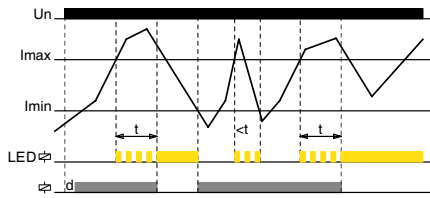

**U2 UNDER (hysteresis to  $I_{max}$ )**

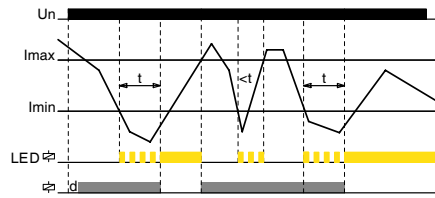

**WL WINDOW + Latch**

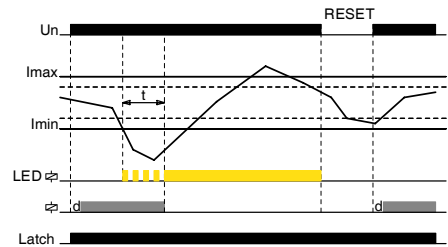

**OL OVER + Latch**

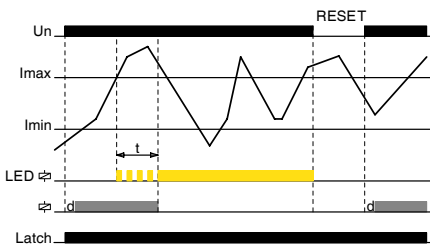

**UL UNDER + Latch**

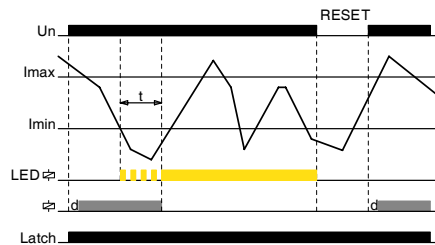

Graphs legend:

$t$  = time delay to fault state

$d$  = delay 0.3 s after connection of power supply ( $Un$ )

### OVER:

- If the value of the monitored current is lower than the set upper level „ $I_{max}$ “, the output contact is closed. If the „ $I_{max}$ “ is exceeded, the output contact will open after the set delay (fault state).
- If the current falls below the fixed hysteresis (function O1) or the set lower level „ $I_{min}$ “ (function O2), the output contact will closes again.
- If the OL function (OVER + Latch) is selected, when the upper current level „ $I_{max}$ “ is exceeded, the output contact remains open even when the current returns from the fault state.

### Fault memory reset can be done in two ways:

- Short-term interruption of supply voltage.
- By setting the function switch to position R (RESET) or any function without memory fault.

The RESET state lasts for 3 s after switching the function switch from the R position to a function with memory fault (UL, OL, WL).

When moving to any other function from the R position, this delay does not apply.

### UNDER:

- If the value of the monitored current is higher than the set lower level „ $I_{min}$ “, the output contact is closed. When the current drops below the „ $I_{min}$ “, output contact opens after the set delay (fault state).
- If the current exceeds the fixed hysteresis (function U1) or the set upper level „ $I_{max}$ “ (function U2), the output contact closes again.
- If the UL function (UNDER + Latch) is selected, when the current drops below the lower level „ $I_{min}$ “, the output contact remains open even when returning from the fault state. Fault memory reset can be done as in the previous case.

### WINDOW:

- If the value of the monitored current is lower than upper level „ $I_{max}$ “ and at the same time higher than lower level „ $I_{min}$ “, the output contact in closed. If the „ $I_{max}$ “ is exceeded or drops below the „ $I_{min}$ “, output contact opens after the set delay (fault state).
- To return from the fault state, a fixed hysteresis is applied.
- If the WL function (WINDOW + Latch) is selected, the fault state is again stored in memory and output contact stays open, even when returning from the fault state. Fault memory reset can be done as in the previous cases.

## Looking for pricing, stock, or lifecycle information?

Click below to explore more details on WIN SOURCE:

-  [View PRI-34/5A on WIN SOURCE](#)
-  [ELKO EP North America LLC Information](#)

## Optimize Your Supply Chain with WIN SOURCE Solutions

-  Global Sourcing Solution
-  Obsolete Management
-  Cost Control Management
-  Shortage Management
-  Alternative Solution
-  Excess Inventory Management