



THE DATASHEET OF HRN-54





EAN code
HRN-54: 8595188137201
HRN-54N: 8595188137218

Technical parameters	HRN-54	HRN-54N
Supply/monitored terminals:	L1-L2-L3	L1-L2-L3-N
Supply/monitored voltage:	3× 400 V (50-60 Hz)	3× 400 V/230 V (50-60 Hz)
Consumption (max.):	2 VA/1 W	
Upper level (U _{max}):	105 - 125 %U _n	
Lower level (U _{min}):	75 - 95 %U _n	
Max. permanent voltage:	AC 3× 460 V	AC 3× 265 V
Peak overload (<1ms):	AC 3× 500 V	AC 3× 288 V
Start delay (t ₁):	max. 500 ms	
Response delay (t ₂):	adjustable, 0.1 - 10 s	
Restart delay (t ₃):	max. 1 s	
Accuracy		
Hysteresis:	2 %	
Output		
Contact type:	1× changeover/SPDT (AgNi)	
Current rating:	8 A/AC1; PD. B300	
Breaking capacity:	2000 VA/AC1, 240 W/DC1	
Inrush current:	10 A	
Switching voltage:	AC 250 V/DC 24 V	
Power dissipation (max.):	0.6 W	
Mechanical life:	60.000.000 ops.	
Electrical life (AC1):	150.000 ops.	
Other information		
Operating temperature:	-20 .. +55 °C (-4 .. +131 °F)	
Storage temperature:	-30 .. +70 °C (-22 .. +158 °F)	
Dielectric strength:	AC 4 kV (supply – output)	
Operating position:	any	
Mounting:	DIN rail EN 60715	
Protection degree:	IP40 front panel/IP10 terminals	
Overvoltage category:	III.	
Pollution degree:	2	
Cross-wire section – solid/ stranded with ferrule (max.):	1× 4; 2× 2.5 mm ² (1× 12; 2× 14 AWG)/ 1× 2.5; 2× 1.5 mm ² (1× 14; 2× 16 AWG)	
Dimensions:	90 × 17.6 × 64 mm (3.5" × 0.7" × 2.5")	
Weight:	62 g (2.19 oz)	63 g (2.22 oz)
Standards:	EN 60255-1, EN 60255-26, EN 60255-27	

Function description

The relay in a 3-phase network monitors the phase voltages magnitude. Two independent voltage levels can be set to monitor undervoltage and overvoltage separately.

Under normal conditions, the output contact remains closed when the voltage stays within the set levels, the red LED stays off. If the voltage exceeds or drops below the set levels, the output contact opens, and the red LED turns on to indicate a fault state (flashing during delay).

If the monitored voltage falls below 60 %U_n (U_{OFF} bottom level, phase failure), the output contact opens immediately without response delay (t₂), and the red LED signals a fault state as in the previous case. If a phase failure occurs during an ongoing response delay the output contact opens immediately.

- **Functionality:** Designed to monitor overvoltage, undervoltage, phase sequence/failure in a 3-phase network, ensuring equipment protection.
- **Power supply:** The relay is powered by the monitored voltage.
- **Adjustable levels:** Both the upper (U_{max}) and lower (U_{min}) voltage levels can be customized.
- **Response delay:** Adjustable response delay to eliminate the effects of short-term voltage drops and spikes.
- **Fault state indication:** Indicated by an illuminated red LED and by the opening of output contact.
- **Phase failure protection:** If any monitored phase drops below 60 %U_n (U_{OFF} bottom level), the output contact opens immediately without delay.
- **HRN-54:** Supply from L1-L2-L3, ensuring the relay remains operational even if one phase fails.
- **HRN-54N:** Supply from L1-L2-L3-N, allows the relay to monitor for neutral wire interruption.

Description

HRN-54

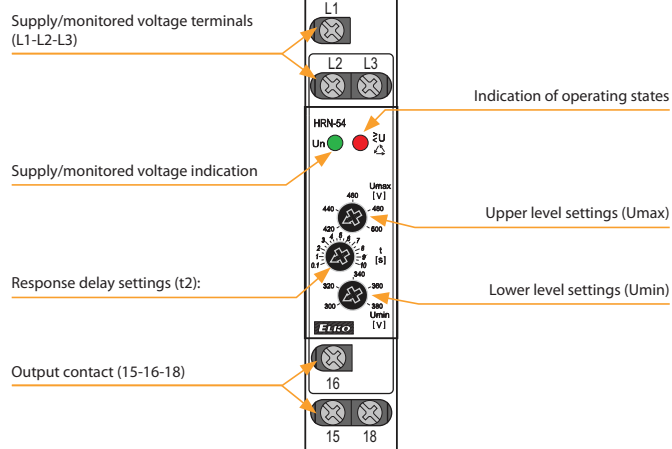

Function

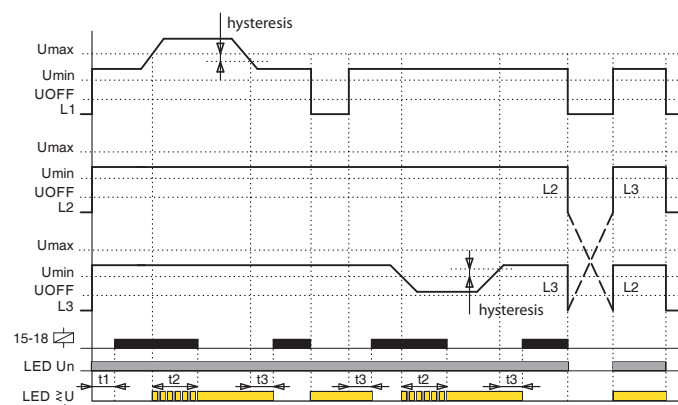

Connection

HRN-54

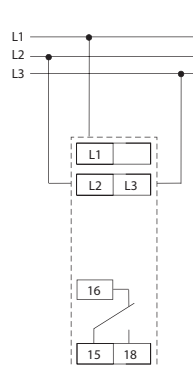

HRN-54N

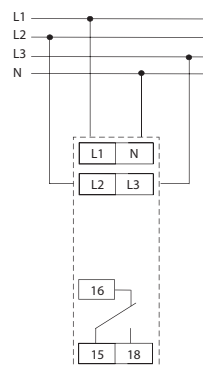

Symbol

HRN-54

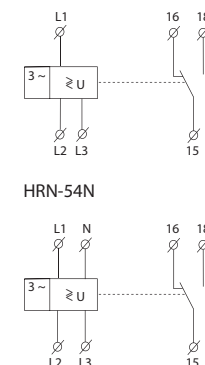

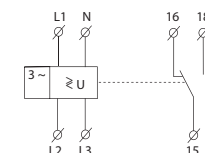

HRN-54N



Looking for pricing, stock, or lifecycle information?

Click below to explore more details on WIN SOURCE:

-  [View HRN-54 on WIN SOURCE](#)
-  [ELKO EP North America LLC Information](#)

Optimize Your Supply Chain with WIN SOURCE Solutions

-  Global Sourcing Solution
-  Obsolete Management
-  Cost Control Management
-  Shortage Management
-  Alternative Solution
-  Excess Inventory Management