

Product Description

Qorvo's TGA2622-SM is a packaged, high power X-Band amplifier fabricated on Qorvo's production 0.25um GaN on SiC process. Operating from 9-10GHz, the TGA2622-SM typically generates 35W of saturated output power with a power-added efficiency greater than 42% and 27.5dB of large signal gain.

The TGA2622-SM is packaged in a 7x7mm air-cavity, laminate based QFN. Both RF ports are internally DC blocked and matched to 50 ohms enabling simple system integration. Ideally suited for pulsed applications, the TGA2622-SM offers superior power, PAE and gain performance that can save costs on existing platforms while enabling the development of future systems.

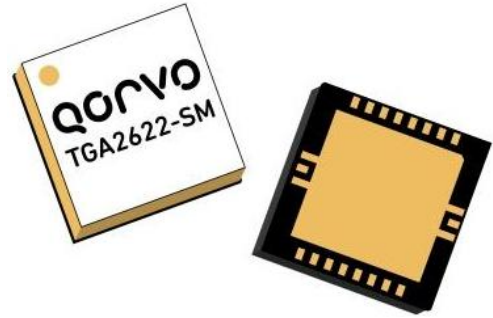

QFN 7x7 mm 22L

Functional Block Diagram

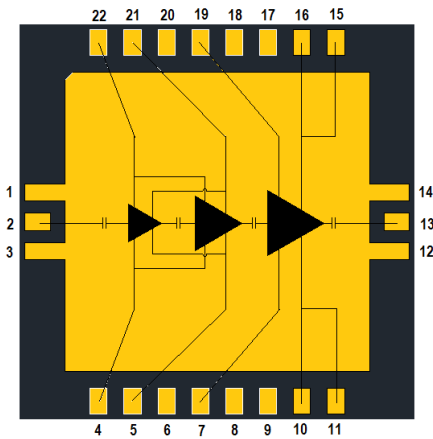

Applications

- Weather and Marine Radar

Product Features

- Frequency Range: 9 – 10 GHz
- P_{SAT} : 45.5 dBm @ $P_{IN} = 18$ dBm
- PAE: 42% @ $P_{IN} = 18$ dBm
- Power Gain: 27.5 dB @ $P_{IN} = 18$ dBm
- Bias: $V_D = 28$ V, $I_{DQ} = 290$ mA
(Pulsed V_D : $PW = 100$ us and $DC = 10$ %)
- Package Dimensions: 7 x 7 x 1.64 mm

Performance is typical across frequency. Please reference electrical specification table and data plots for more details.

Ordering Information

Part	Description
TGA2622-SM	9 – 10 GHz 35 W GaN Power Amplifier
TGA2622-SM EVB	Evaluation Board

Absolute Maximum Ratings

Parameter	Value
Drain Voltage (V_D)	40 V
Gate Voltage Range (V_G)	-8 to 0V
Drain Current (I_D)	4.3 A
Gate Current (I_G)	See page 11
Power Dissipation (P_{DISS}), 85°C, CW	88 W
Input Power (P_{IN}), CW, 50Ω, $V_D = 28V$, 85°C	24 dBm
Input Power (P_{IN}), CW, VSWR 3:1, $V_D = 28V$, 85°C	24 dBm
Mounting Temperature (30 seconds)	260 °C
Storage Temperature	-55 to 150 °C

Operation of this device outside the parameter ranges given above may cause permanent damage. These are stress ratings only, and functional operation of the device at these conditions is not implied.

Recommended Operating Conditions

Parameter	Value
Drain Voltage (V_D)	28 V
Drain Current (quiescent, I_{DQ})	290 mA
Gate Voltage Range (V_G)	-2.8 to -2.0 V
Operating Temperature Range	-40 to 85 °C

Electrical specifications are measured at specified test conditions. Specifications are not guaranteed over all recommended operating conditions.

Electrical Specifications

Test conditions unless otherwise noted: 25 °C, $V_D = 28 V$, $I_{DQ} = 290 mA$, Pulsed V_D : PW = 100 us, DC = 10%

Parameter		Min	Typ	Max	Units
Operational Frequency Range		9	–	10	GHz
Output Power @ $P_{IN} = 18 dBm$	Frequency = 9 GHz	45	45.7	–	dBm
	Frequency = 9.5 GHz	45	45.8	–	dBm
	Frequency = 10 GHz	45	45.8	–	dBm
Power Added Efficiency @ $P_{IN} = 18 dBm$	Frequency = 9 GHz	40	46.4	–	%
	Frequency = 9.5 GHz	40	46.4	–	
	Frequency = 10 GHz	35	43	–	
Small Signal Gain	Frequency = 9 GHz	–	31.5	–	dB
	Frequency = 9.5 GHz	–	32.7	–	
	Frequency = 10 GHz	–	31.4	–	
Input Return Loss	Frequency = 9 GHz	–	14.7	–	dB
	Frequency = 9.5 GHz	–	15	–	
	Frequency = 10 GHz	–	11	–	
Output Return Loss	Frequency = 9 GHz	–	10.6	–	dB
	Frequency = 9.5 GHz	–	9.3	–	
	Frequency = 10 GHz	–	12	–	
Output Power Temperature Coefficient From 25°C to 85°C ($P_{in} = 18dBm$)		–	-0.02	–	dBm/°C

Performance Plots – Large Signal (Pulsed)

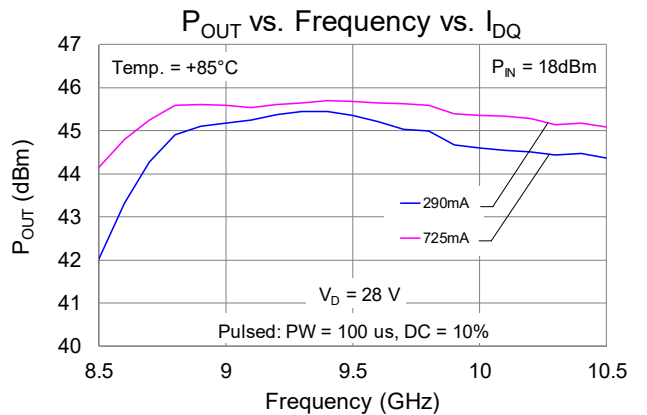
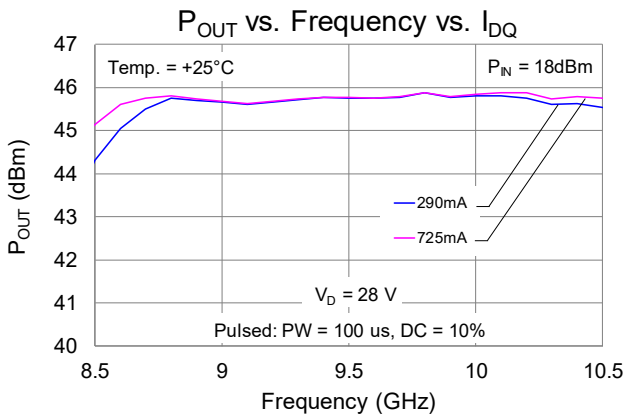
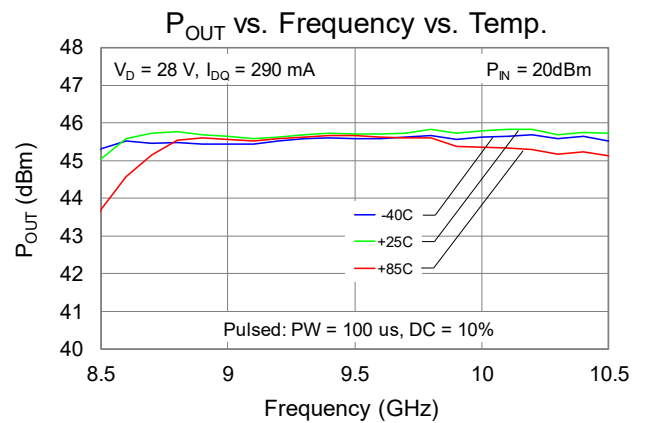
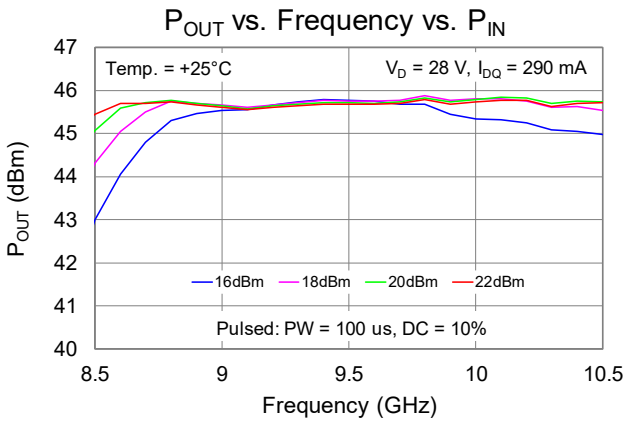
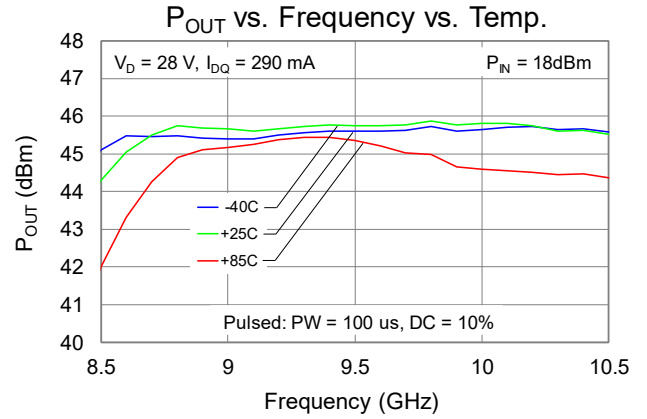
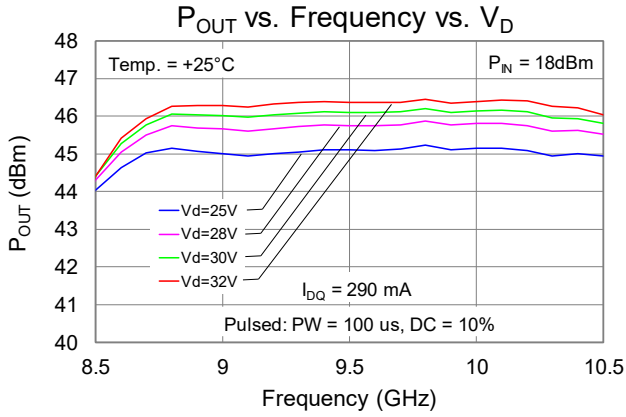

Performance Plots – Large Signal (Pulsed)

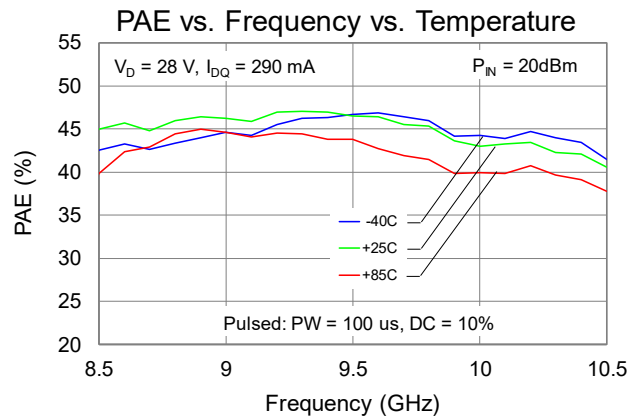
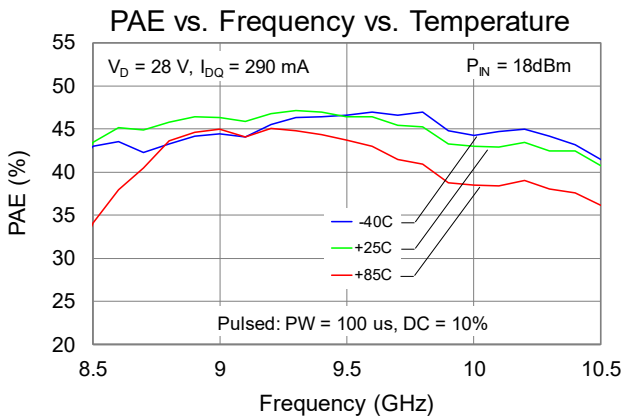
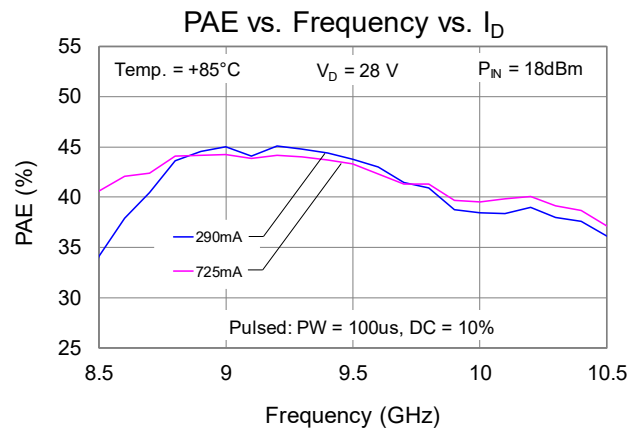
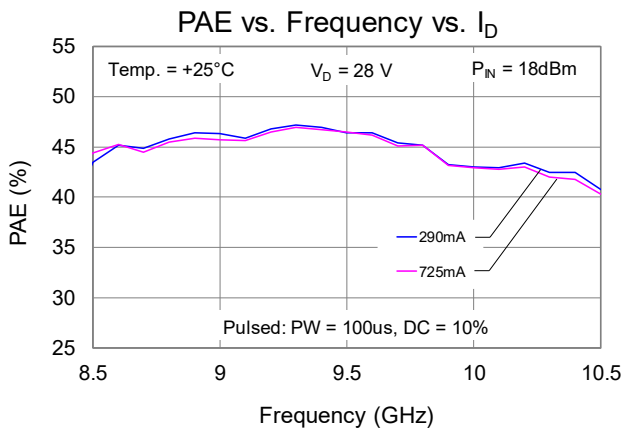
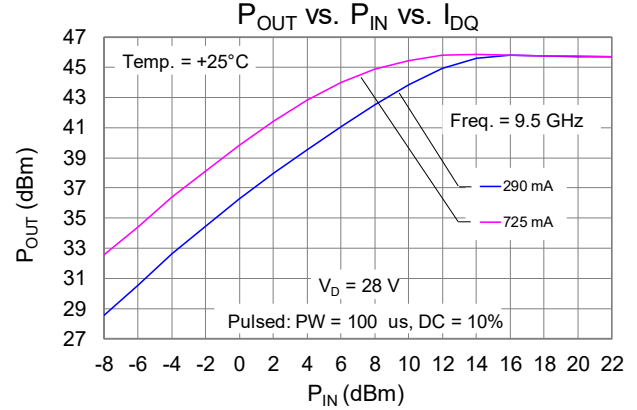
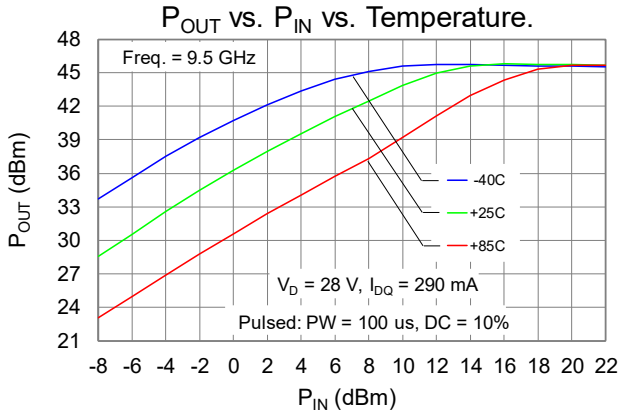

Performance Plots – Large Signal (Pulsed)

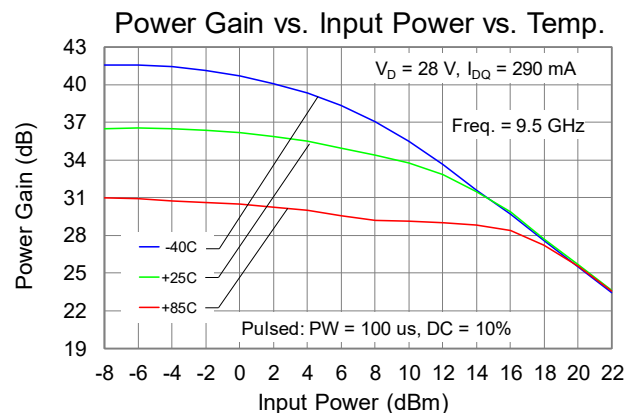
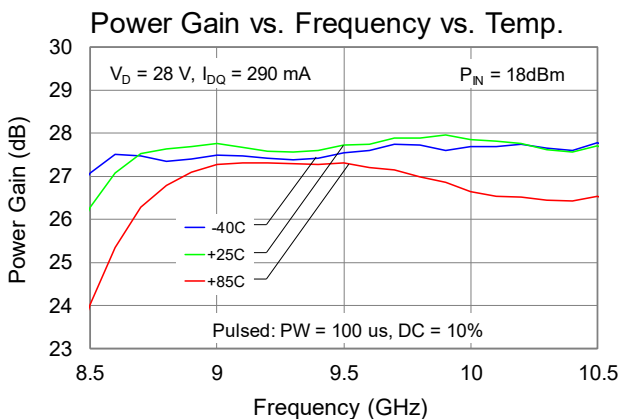
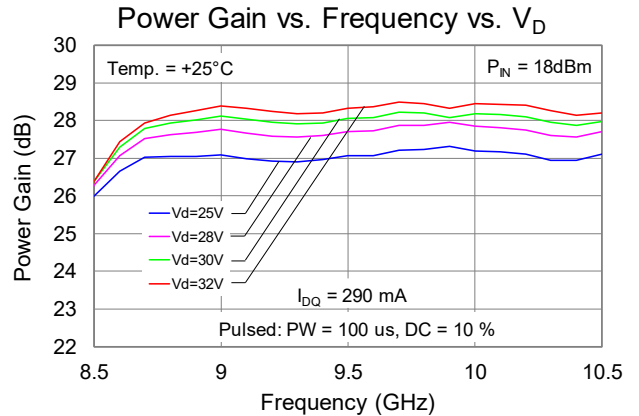
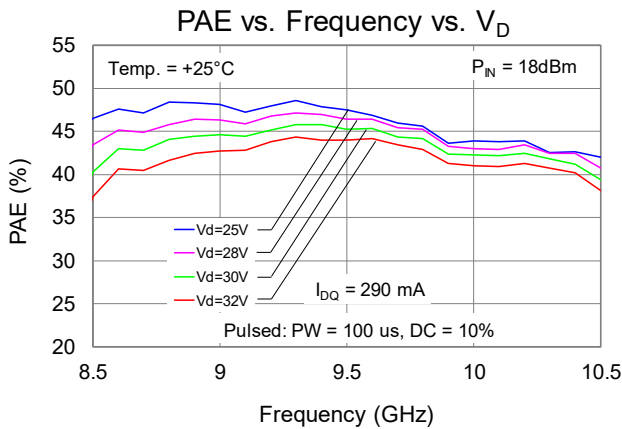
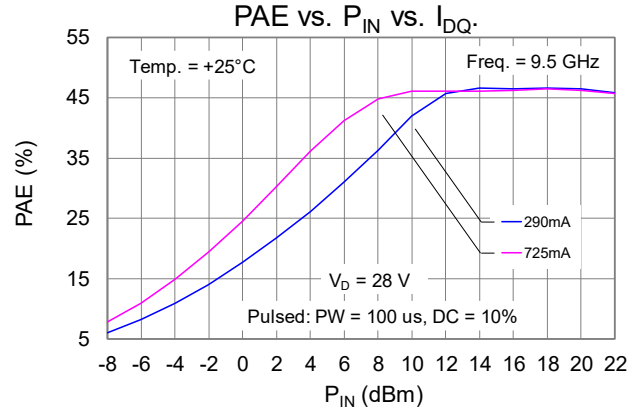
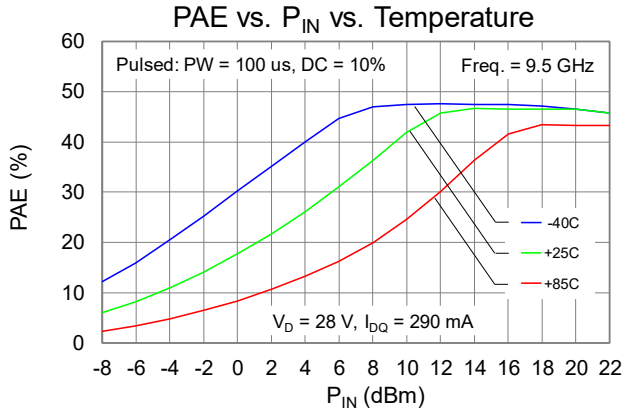

Performance Plots – Large Signal (Pulsed)

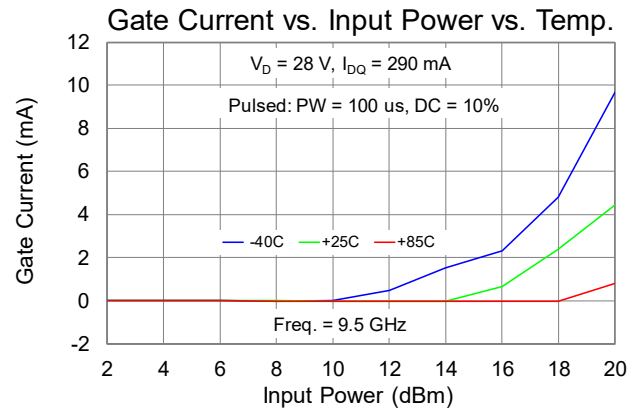
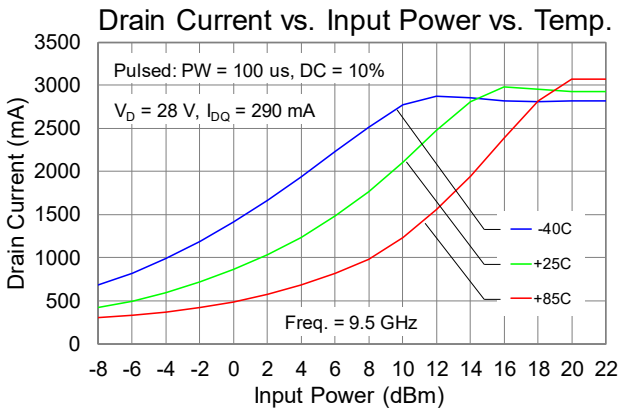
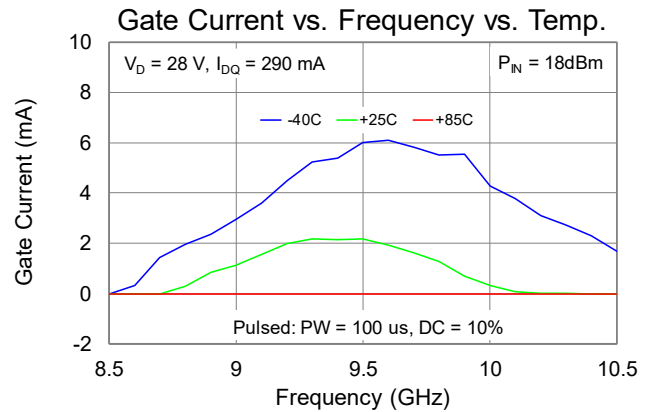
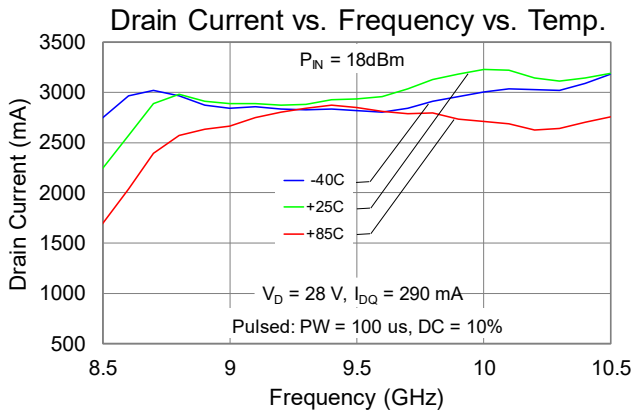
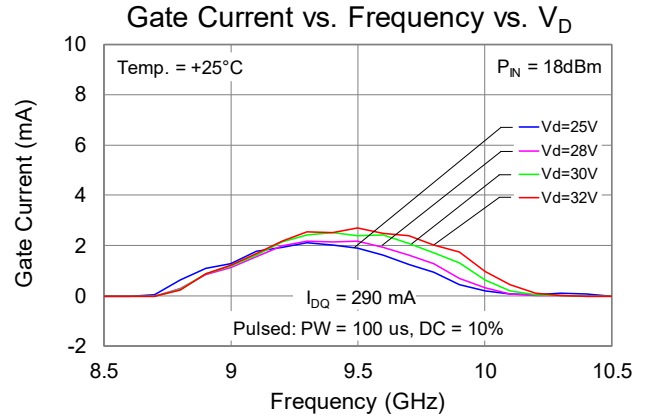
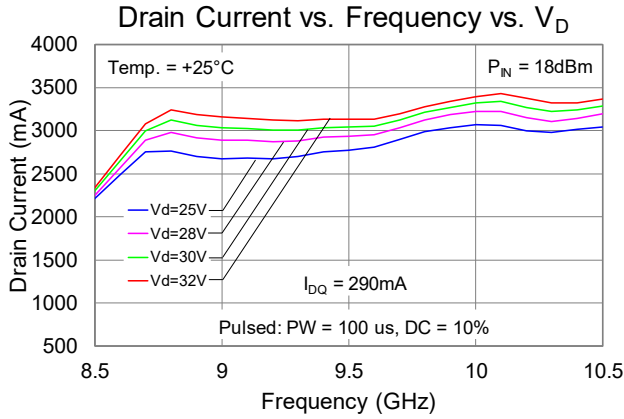

Performance Plots – Linearity (CW)

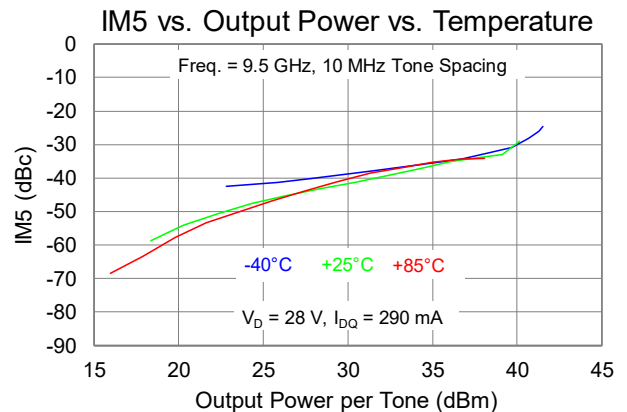
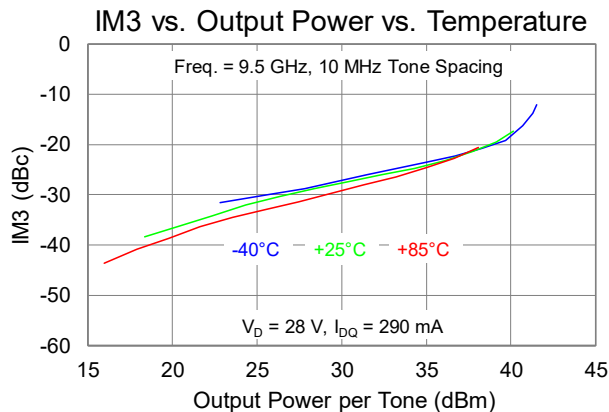
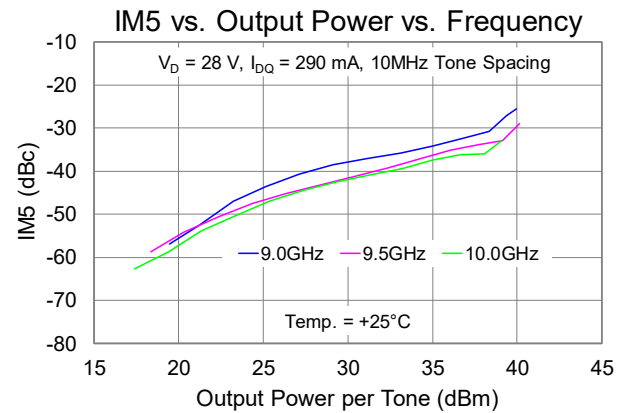
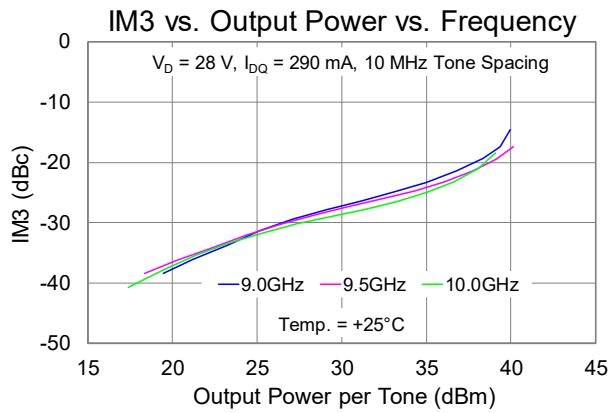
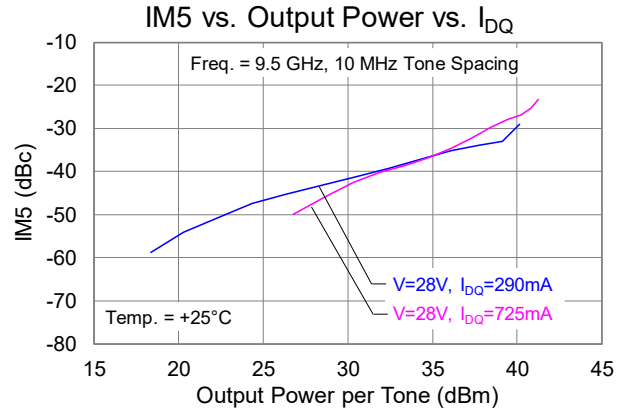
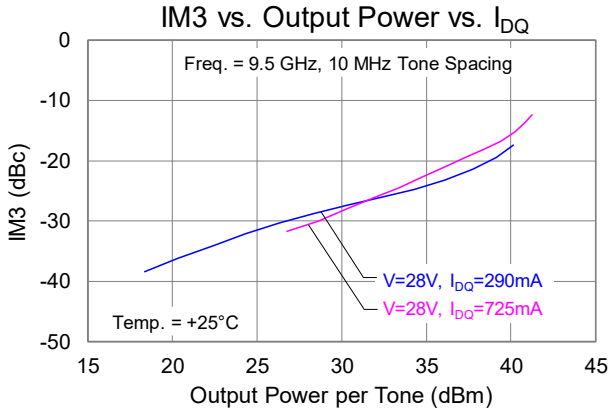

Performance Plots – Linearity (CW)

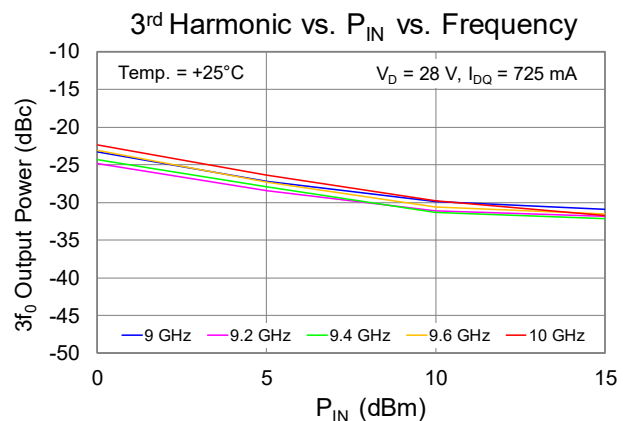
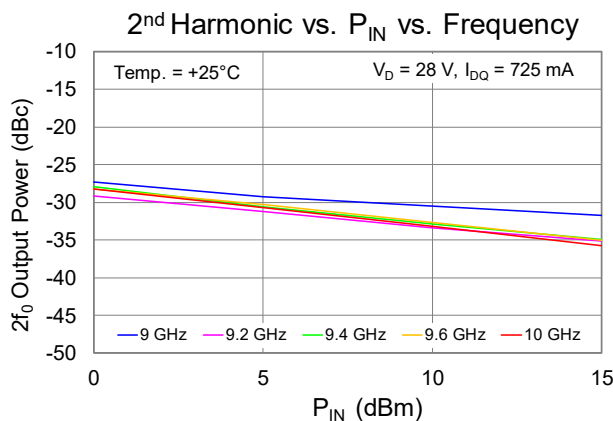
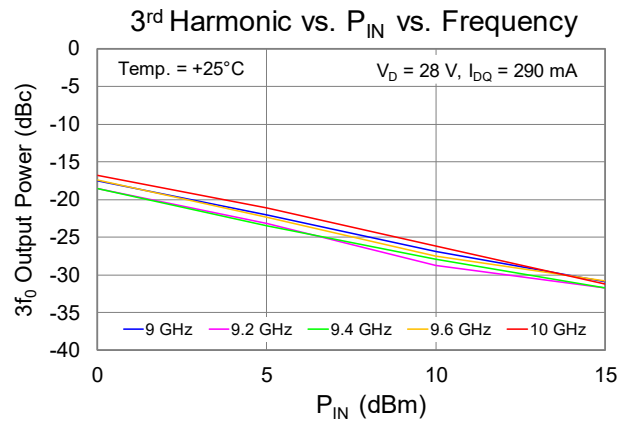
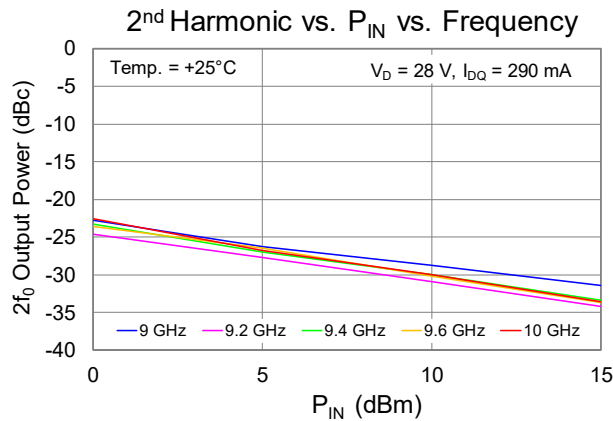
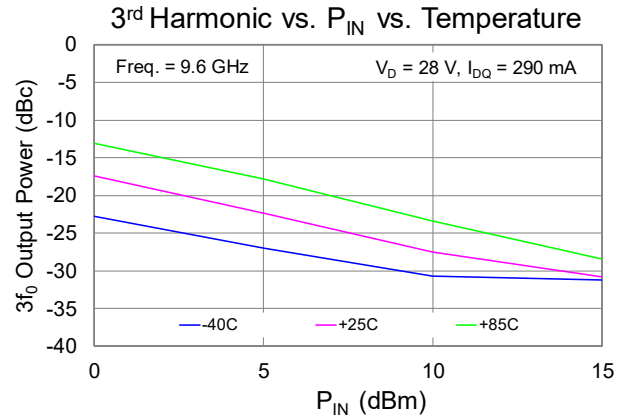
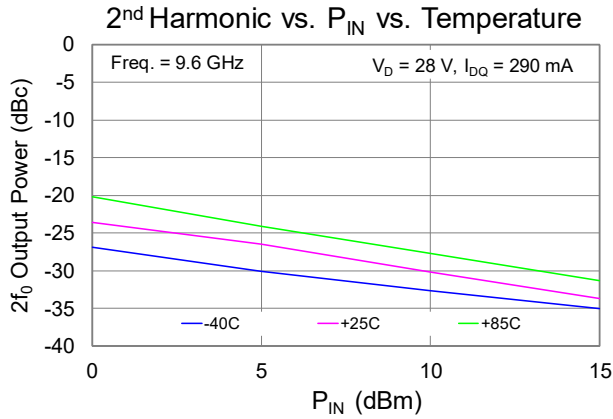

Performance Plots – Small Signal (CW)

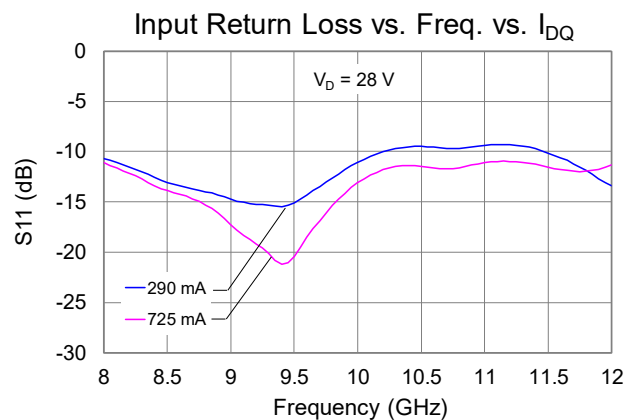
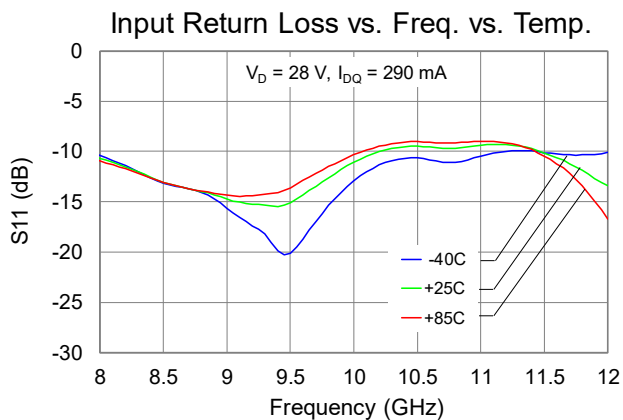
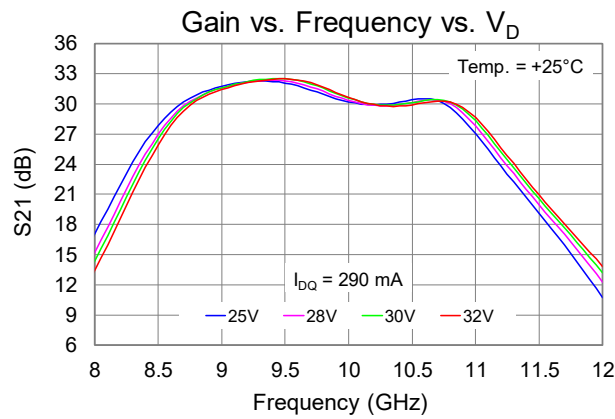
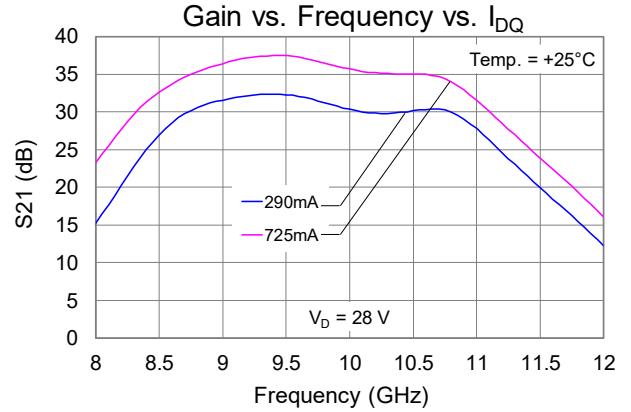
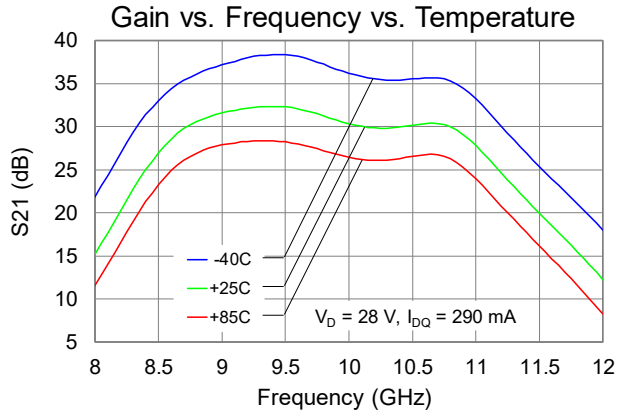

Performance Plots – Small Signal (CW)

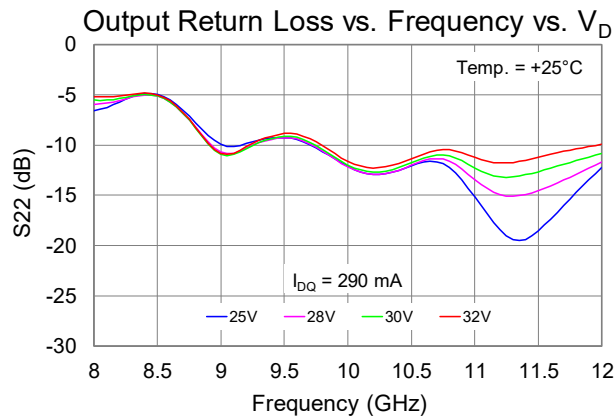
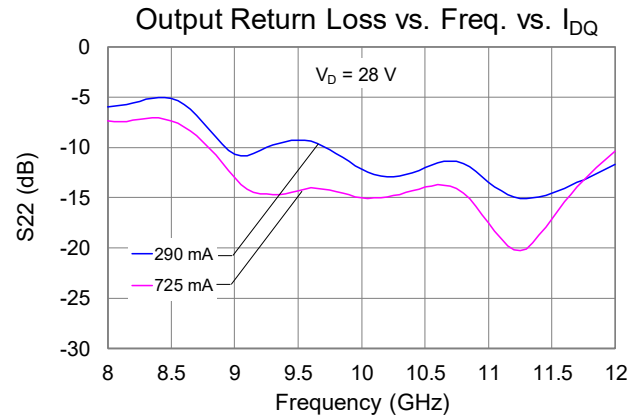
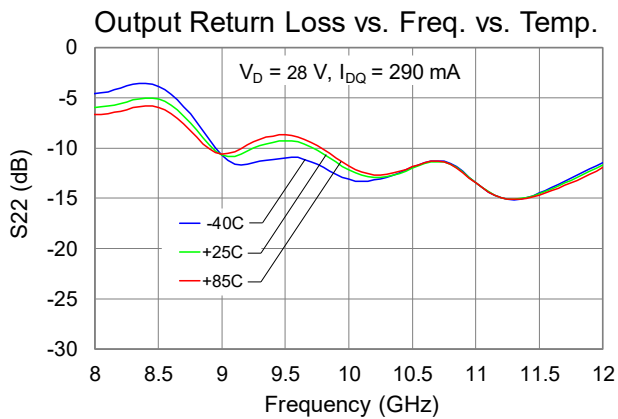
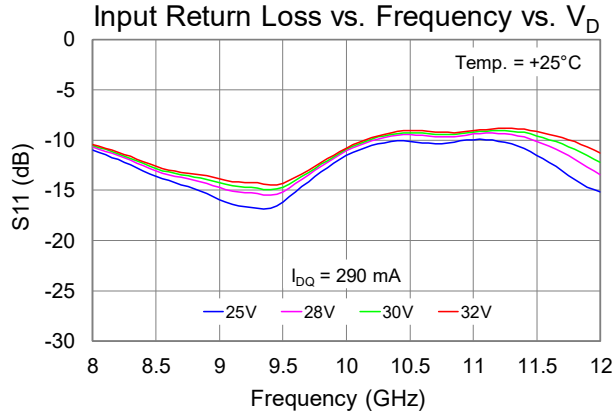

Thermal and Reliability Information

Parameter	Test Conditions	Value	Units
Thermal Resistance (θ_{JC}) ⁽¹⁾	T _{base} = 85 °C, V _D = 28 V, I _{DQ} = 290 mA, Small signal or quiescent. P _{DISS} = 8.12 W	0.51	°C/W
Channel Temperature (T _{CH}) (Small Signal) ²		89.1	°C
Thermal Resistance (θ_{JC}) ⁽¹⁾	T _{base} = 85 °C, V _D = 28 V, I _{DQ} = 290 mA, Pulsed V _D , PW = 100 us, DC = 10 %, I _{D_Drive} = 3.1 A, P _{IN} = 20 dBm, P _{OUT} = 45.4 dBm, P _{DISS} = 52 W	0.73	°C/W
Channel Temperature (T _{CH}) (With RF drive) ²		123.2	°C
Thermal Resistance (θ_{JC}) ⁽¹⁾	T _{base} = 85 °C, V _D = 28 V, I _{DQ} = 290 mA, CW, I _{D_Drive} = 3.1 A, P _{IN} = 20 dBm, P _{OUT} = 45.4 dBm, P _{DISS} = 52 W	1.19	°C/W
Channel Temperature (T _{CH}) (With RF drive) ²		146.9	°C

Notes:

1. Thermal Resistance referenced to the back of the package.
2. IR scan equivalent. Refer to the following document: [GaN Device Channel Temperature, Thermal Resistance, and Reliability Estimates](#)

Power Dissipation and Maximum Gate Current

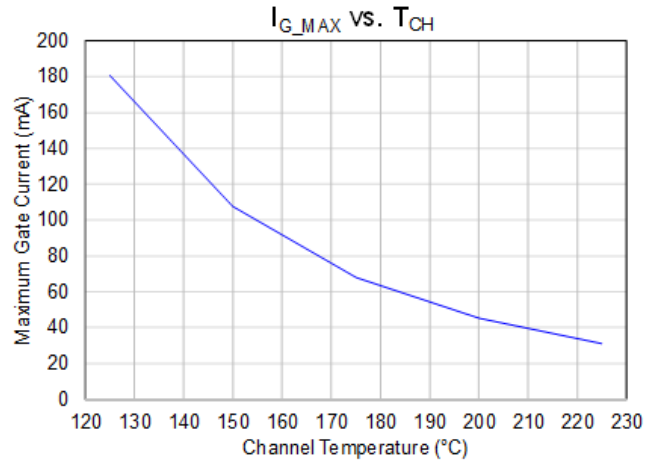
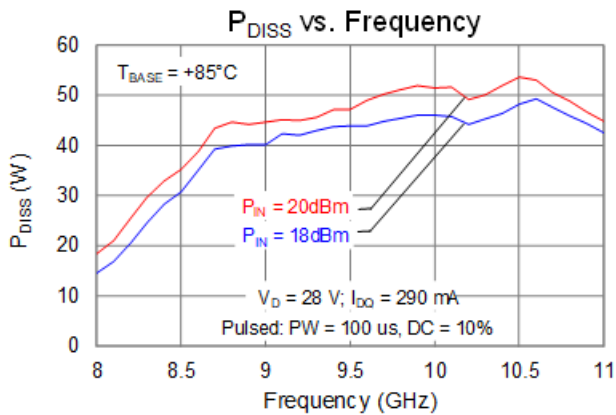

Applications Circuit

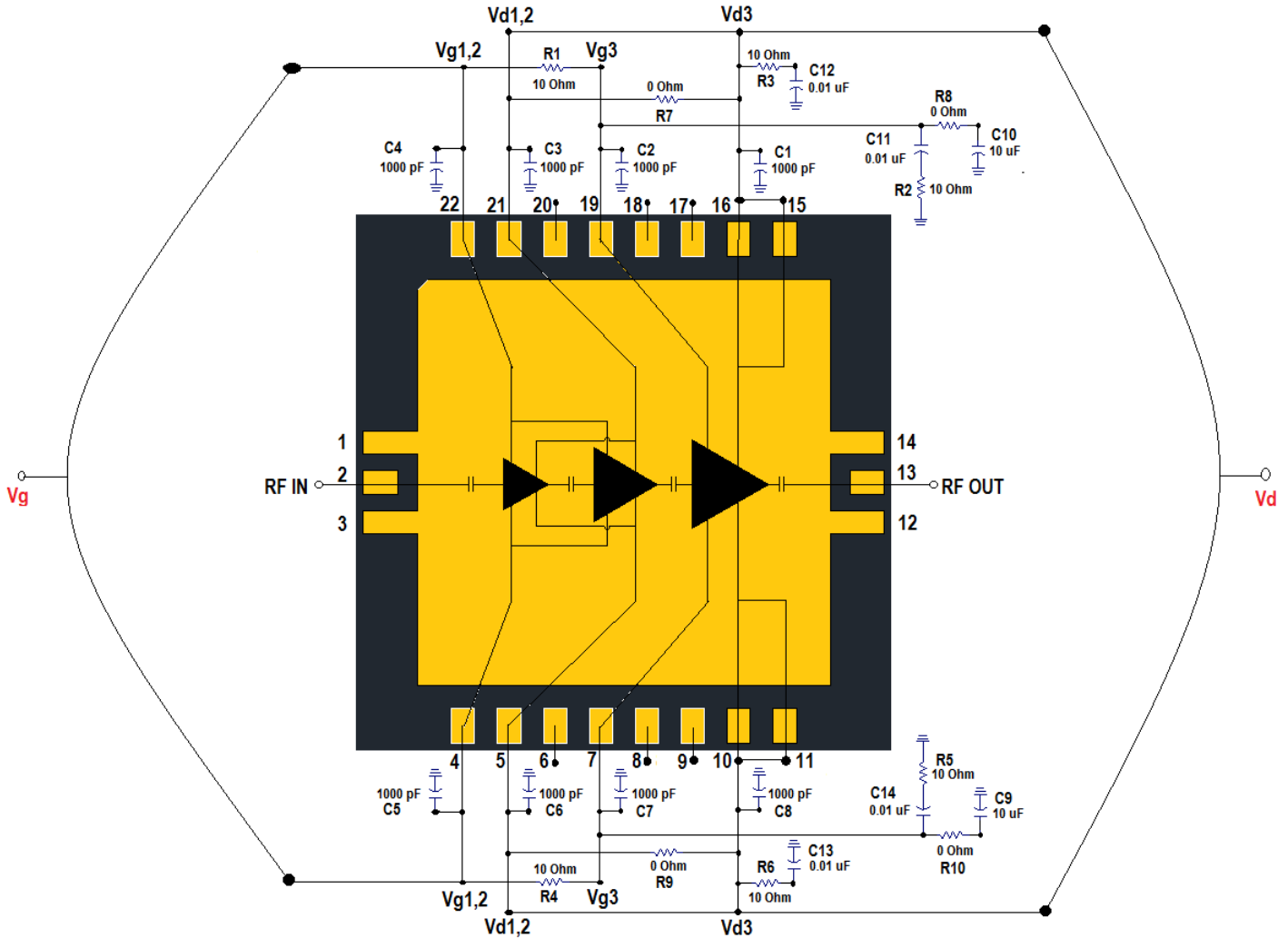

Notes:

1. V_G : must be biased from both sides - $V_{G1,2}$ & V_{G3} can be tied together.
2. V_D : must be biased from both sides - $V_{D1,2}$ & V_{D3} can be tied together.

Bias Up Procedure

1. Set I_D limit to 3.5 A, I_G limit to 25 mA
2. Set V_G to -5.0 V (for pinch-off)
3. Set V_D +28 V; Ensure I_{DQ} is approx. 0 mA
4. Adjust V_G more positive until $I_{DQ} = 290$ mA ($V_G \sim -2.3$ V Typical)
5. Apply RF signal

Bias Down Procedure

1. Turn off RF supply
2. Reduce V_G to -5.0 V. Ensure $I_{DQ} \sim 0$ mA
3. Set V_D to 0 V
4. Turn off V_D supply
5. Turn off V_G supply

Mechanical Drawing and Pin Layout

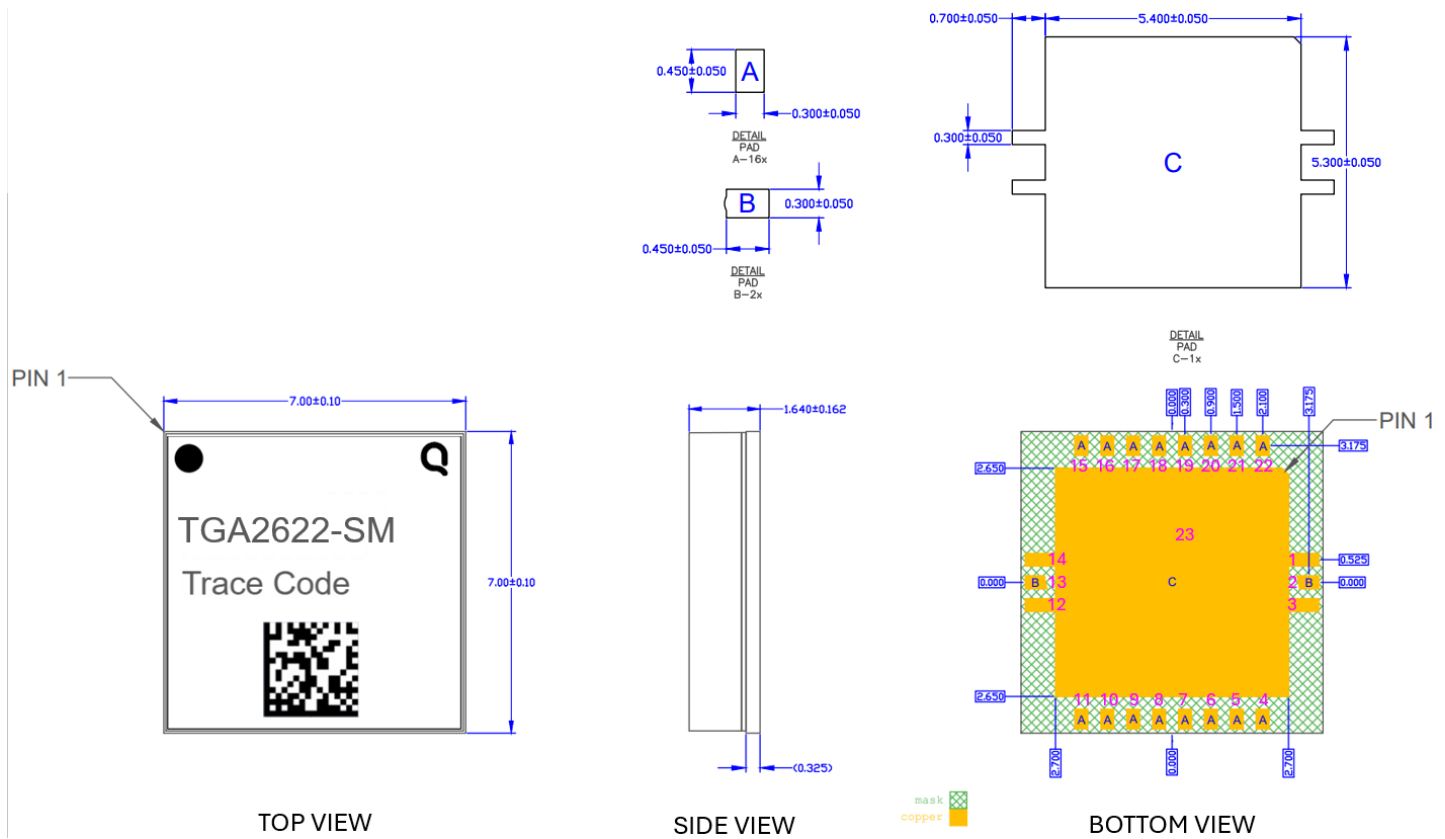

Units: Millimeters (mm)
 Tolerances: unless specified: x.xx = ± 0.25; x.xxx = ± 0.100
 Materials: Base: Laminate Substrate
 Lid: Laminate
 All metalized features are gold plated. Part is epoxy sealed
 2DID Marking can be used to trace part manufacturing information

Pin Description

Pin No.	Symbol	Description
1, 3, 12, 14, 23	GND	Must be grounded on the PCB
2	RF _{IN}	Input; matched to 50 Ω; DC blocked
4, 22	V _{G1,2}	Gate Voltages 1,2; Bias network is required; must be biased from both sides; see recommended Application Information on page 12.
5, 21	V _{D1,2}	Drain voltages 1,2; Bias network is required; must be biased from both sides; see recommended Application Information on page 12.
6, 8, 9, 17, 18, 20	N/C	No internal connection
7, 19	V _{G3}	Gate Voltage 3; Bias network is required; must be biased from both sides; see recommended Application Information on page 12.
10, 11, 15, 16	V _{D3}	Drain voltage 3; Bias network is required; must be biased from both sides; see recommended Application Information on page 12.
13	RF _{OUT}	Output; matched to 50 Ω; DC blocked

Evaluation Board Layout

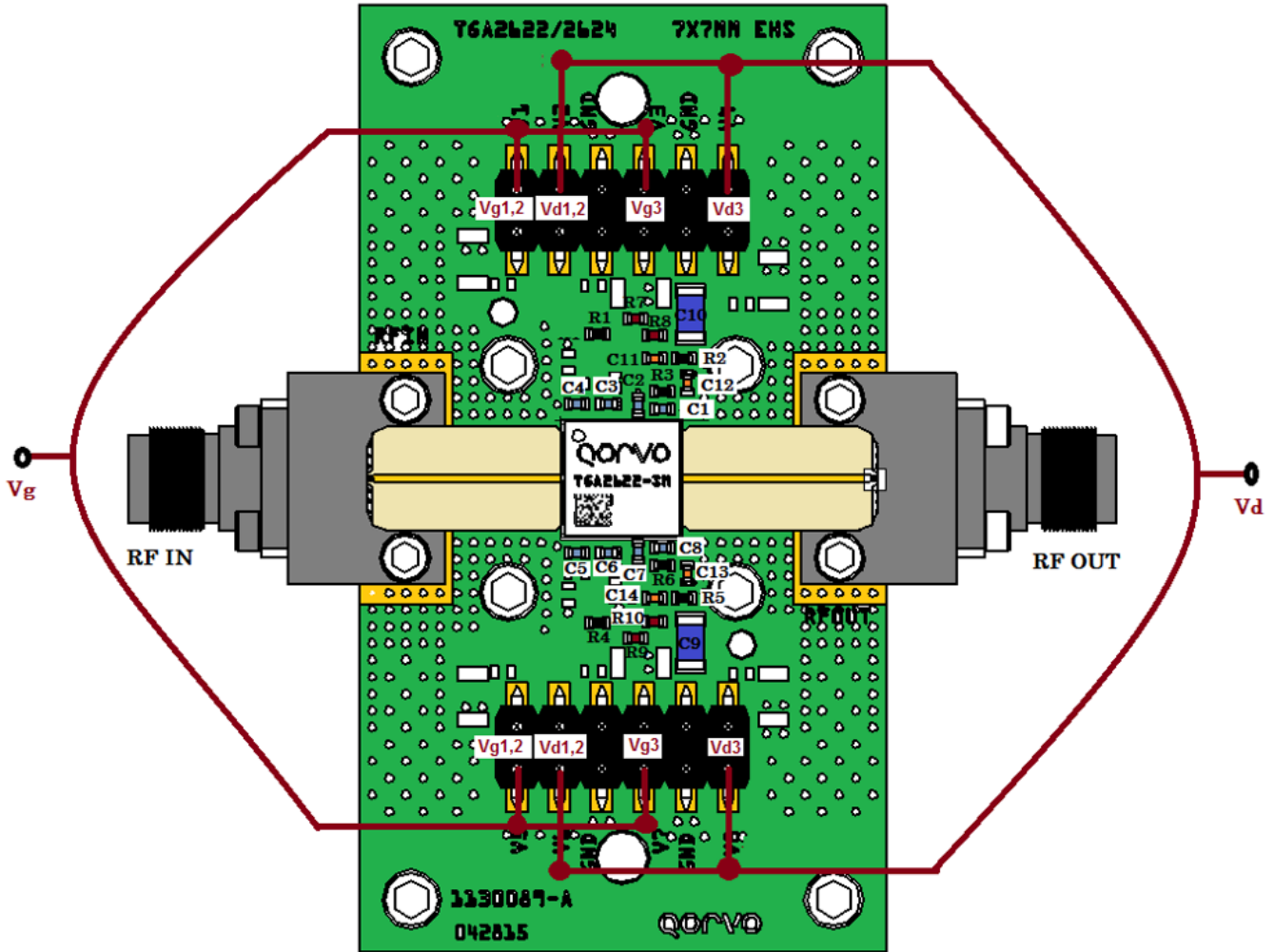

Notes: Both Top and Bottom Vd and Vg must be biased.

Bill of Materials

Reference Des.	Value	Description	Manuf.	Part Number
C1 – C8	1000 pF	Cap, 0402, 100 V, 10%, X7R	Various	
C9 – C10	10 μF	Cap, 1206, 50 V, 20%, X5R	Various	
C11 – C14	0.01 μF	Cap, 0402, 50 V, 10%, X7R	Various	
R1 – R6	10 ohms	Res, 0402, 50 V, 5%, SMD	Various	
R7 – R10	0 ohms	Res, 0402, jumpers required for the above EVB	Various	

Assembly Notes

Compatible with lead-free soldering processes with 260°C peak reflow temperature.

This package is air-cavity and non-hermetic, and therefore cannot be subjected to aqueous washing. The use of no-clean solder to avoid washing after soldering is highly recommended.

Contact plating: Ni-Au.

Solder rework not recommended.

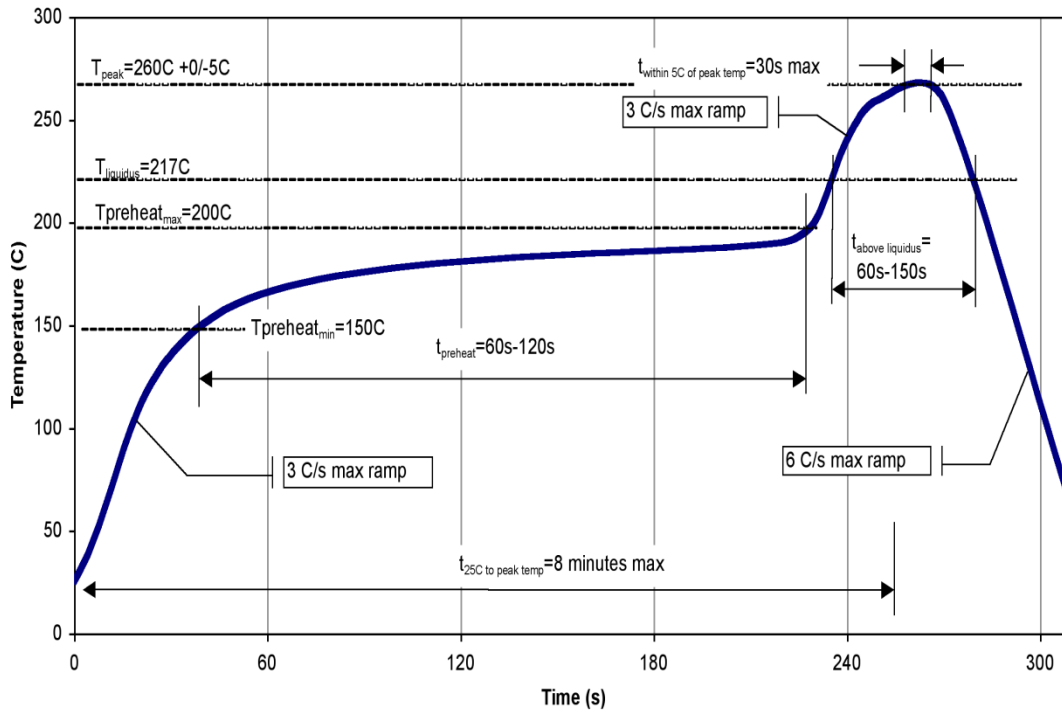

Recommended Soldering Temperature Profile

Handling Precautions

Parameter	Rating	Standard
ESD – Human Body Model (HBM)	Class 1B	ANSI/ESD/JEDEC JS-001
MSL – Moisture Sensitivity Level	Level 3	IPC/JEDEC J-STD-020



Caution!
ESD-Sensitive Device

RoHS Compliance

This product is compliant with the 2011/65/EU RoHS directive (Restrictions on the Use of Certain Hazardous Substances in Electrical and Electronic Equipment), as amended by Directive 2015/863/EU.

This product also has the following attributes:

- Lead Free
- Antimony Free
- TBBP-A (C₁₅H₁₂Br₄O₂) Free
- PFOS Free
- SVHC Free

Contact Information

For the latest specifications, additional product information, worldwide sales and distribution locations:

Tel: 1-844-890-8163

Web: www.qorvo.com

Email: info-sales@qorvo.com

For technical questions and application information: **Email:** info-products@qorvo.com

Important Notices

The information contained in this Data Sheet and any associated documents (“Data Sheet Information”) is believed to be reliable; however, Qorvo makes no warranties regarding the Data Sheet Information and assumes no responsibility or liability whatsoever for the use of or reliance on said information. All Data Sheet Information is subject to change without notice. Customers should obtain and verify the latest relevant Data Sheet Information before placing orders for Qorvo® products. Information concerning Qorvo’s product life cycles is available at <https://www.qorvo.com/support/product-lifecycle-information>. Data Sheet Information or the use thereof does not grant, explicitly, implicitly or otherwise any rights or licenses with respect to patents or any other intellectual property whether with regard to such Data Sheet Information itself or anything described by such information.

Qorvo grants you permission to use this Data Sheet and any associated resources only to develop an application that uses the Qorvo products described in the Data Sheet and any associated resources. Other reproduction and display of this Data Sheet and any associated resources is prohibited.

Qorvo’s products are provided subject to Qorvo’s [Terms of Sale](#) or provided in conjunction with such Qorvo products. Qorvo objects to and rejects any additional or different terms customer may have proposed regarding the purchase of Qorvo products.

DATA SHEET INFORMATION DOES NOT CONSTITUTE A WARRANTY WITH RESPECT TO THE PRODUCTS DESCRIBED HEREIN, AND QORVO HEREBY DISCLAIMS ANY AND ALL WARRANTIES WITH RESPECT TO SUCH PRODUCTS WHETHER EXPRESS OR IMPLIED BY LAW, COURSE OF DEALING, COURSE OF PERFORMANCE, USAGE OF TRADE OR OTHERWISE, INCLUDING THE IMPLIED WARRANTIES OF MERCHANTABILITY AND FITNESS FOR A PARTICULAR PURPOSE. Without limiting the generality of the foregoing, Qorvo® products are not warranted or authorized for use as critical components in medical, life-saving, or life-sustaining applications, or other applications where a failure would reasonably be expected to cause severe personal injury or death. Applications described in the Data Sheet Information are for illustrative purposes only. Customers are responsible for validating that a particular product described in the Data Sheet Information is suitable for use in a particular application.

© 2026 Qorvo US, Inc. All rights reserved. This document is subject to copyright laws in various jurisdictions worldwide and may not be reproduced or distributed, in whole or in part, without the express written consent of Qorvo US, Inc.

Looking for pricing, stock, or lifecycle information?

Click below to explore more details on WIN SOURCE:

 [View TGA2622-SMTR7 on WIN SOURCE](#)

 [Qorvo US Inc. Information](#)

Optimize Your Supply Chain with WIN SOURCE Solutions

-  Global Sourcing Solution
-  Obsolete Management
-  Cost Control Management
-  Shortage Management
-  Alternative Solution
-  Excess Inventory Management