

Product Overview

Qorvo’s TGA2624 is an x-band, high power MMIC amplifier fabricated on Qorvo’s production 0.25 um GaN on SiC process (QGaN25). The TGA2624 operates from 9 – 10 GHz and provides a superior combination of power, gain, and efficiency.

Achieving 18 W of saturated output power with 27.5 dB of large signal gain and greater than 40% power-added efficiency, the TGA2624 provides the level of performance demanded by today’s system architectures.

Depending on the system requirements, the TGA2624 can support cost saving initiatives on existing systems while supporting next generation systems with increased performance.

Lead-free and RoHS compliant.



Functional Block Diagram

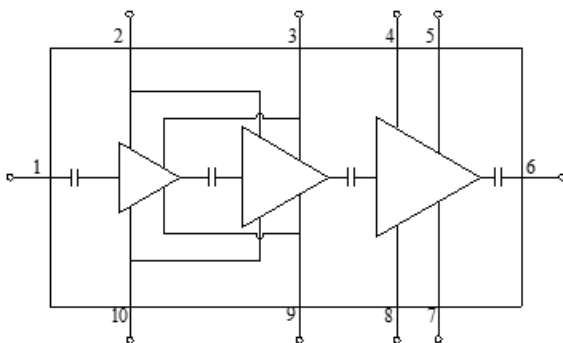

Key Features

- Frequency Range: 9 – 10 GHz
- P_{SAT}: 42.5 dBm (P_{IN} = 15 dBm)
- P1dB: > 38dBm
- PAE: > 40% (P_{IN} = 15 dBm)
- Large Signal Gain: 27.5 dB
- Small Signal Gain: > 35 dB
- Return Loss: > 11 dB
- Bias: V_D = 28 V, I_{DQ} = 365 mA
- Pulsed V_D: PW = 100 us and DC = 10%
- Die Dimensions: 5.0 x 2.62 x 0.10 mm

Performance is typical across frequency. Please reference electrical specification table and data plots for more details.

Applications

- Weather and Marine Radar

Ordering Information

Part No.	Description
TGA2624	9–10 GHz 18 Watt GaN Amplifier (10 Pcs.)
TGA2624EVB	Evaluation Board for TGA2624

Absolute Maximum Ratings

Parameter	Value / Range
Drain Voltage (V_D)	40 V
Gate Voltage Range (V_G)	-5 to 0 V
Drain Current (I_{D1-2})	1.6 A
Drain Current (I_{D3})	2.1 A
Gate Current (I_{G1-2})	See plot, page 9
Gate Current (I_{G3})	See plot, page 9
Power Dissipation (P_{DISS}), 85°C	49 W
Input Power (P_{IN}), CW, 50Ω, $V_D = 28V$, 85°C	25 dBm
Input Power (P_{IN}), CW, VSWR 6:1, $V_D = 28V$, 85°C	19 dBm
Soldering Temperature (30 s, max.)	320 °C
Storage Temperature	-55 to +150 °C

Operation of this device outside the parameter ranges given above may cause permanent damage. These are stress ratings only, and functional operation of the device at these conditions is not implied.

Recommended Operating Conditions

Parameter	Value / Range
Drain Voltage (V_D)	28 V
Drain Current (I_{DQ})	365 mA
Operating Temperature	-40 to +85 °C

Electrical specifications are measured at specified test conditions. Specifications are not guaranteed over all recommended operating conditions.

Electrical Specifications

Parameter	Min	Typ	Max	Units
Operational Frequency Range	9		10	GHz
Small Signal Gain		>35		dB
Input Return Loss		>11		dB
Output Return Loss		>11		dB
Output Power ($P_{in} = 15dBm$)	41.5	>42.5		dBm
Power Added Efficiency ($P_{in} = 15dBm$)	37	>40		%
Power @ 1dB Compression (P_{1dB})		>38		dBm
Small Signal Gain Temperature Coefficient		-0.06		dB/°C
Recommended Operating Voltage:	20	28	32	V

Test conditions unless otherwise noted: 25 °C, $V_D = 28 V$, $I_{DQ} = 365 mA$, Pulsed V_D , $PW = 100 us$, $DC = 10\%$

Performance Plots – Large Signal (Pulsed)

Test conditions unless otherwise noted: 25 °C, $V_D = 28$ V, $I_{DQ} = 365$ mA, Pulsed V_D , PW = 100 us, DC = 10%

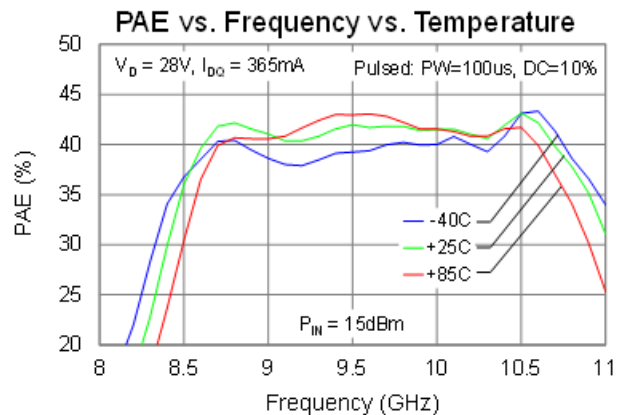
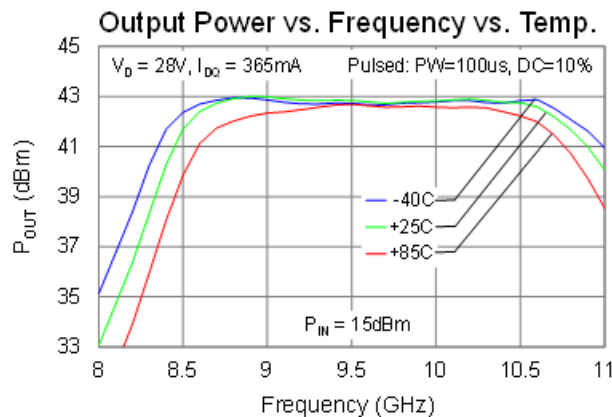
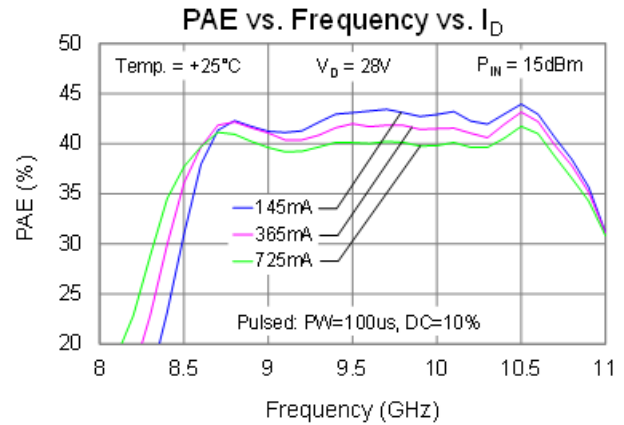
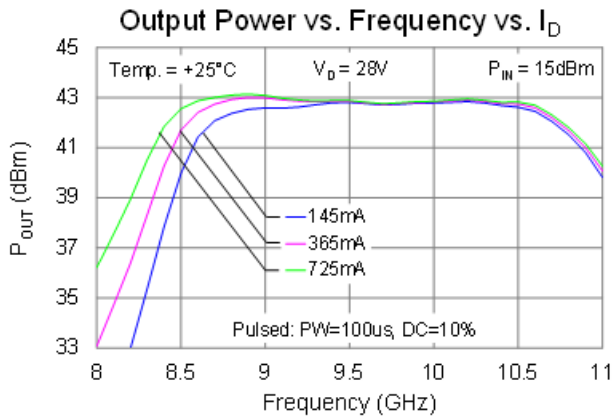
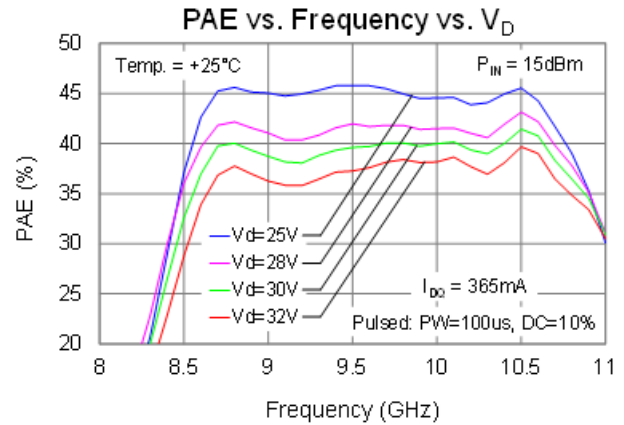
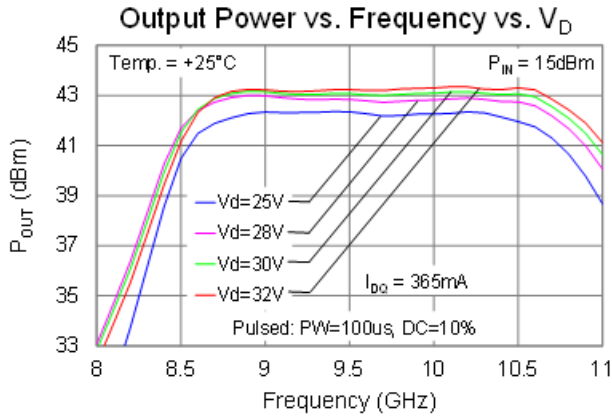

Performance Plots – Large Signal (Pulsed)

Test conditions unless otherwise noted: 25 °C, $V_D = 28$ V, $I_{DQ} = 365$ mA, Pulsed V_D , PW = 100 us, DC = 10%

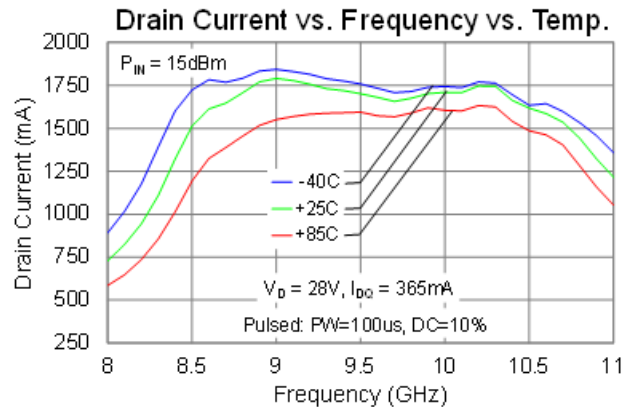
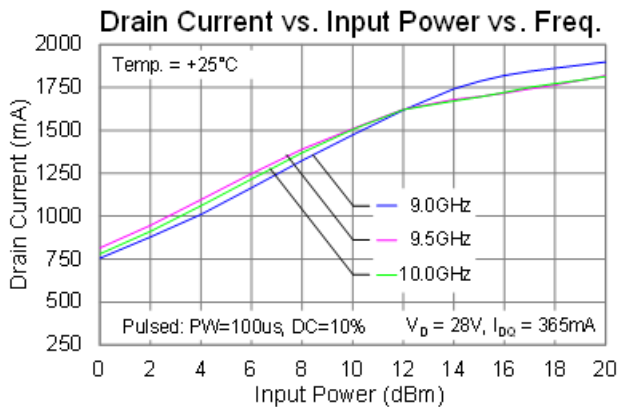
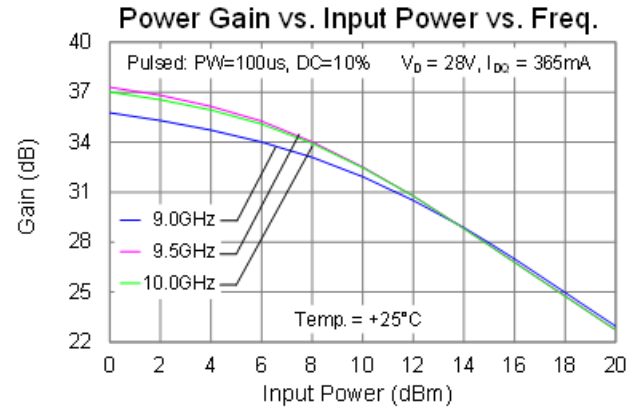
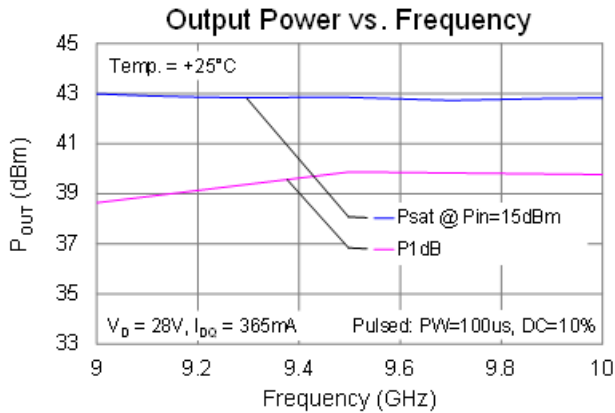
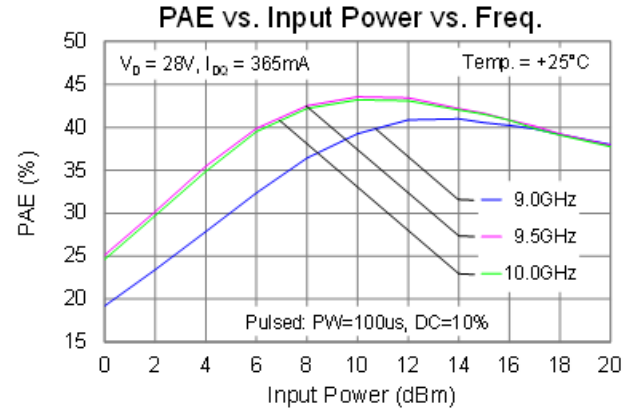
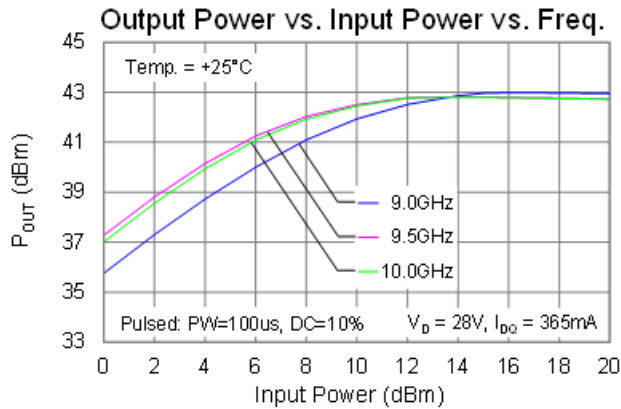

Performance Plots – Large Signal (CW)

Test conditions unless otherwise noted: 25 °C, $V_D = 28$ V, $I_{DQ} = 365$ mA, CW

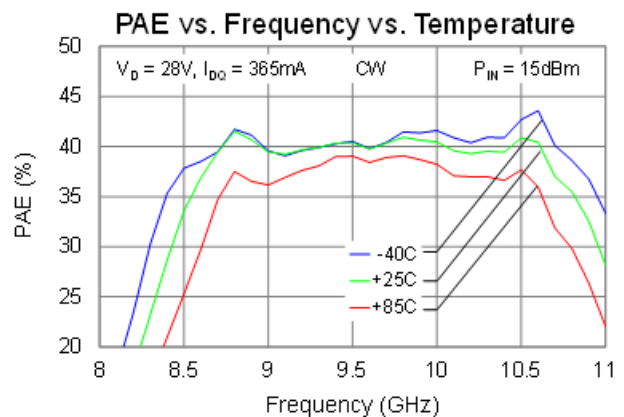
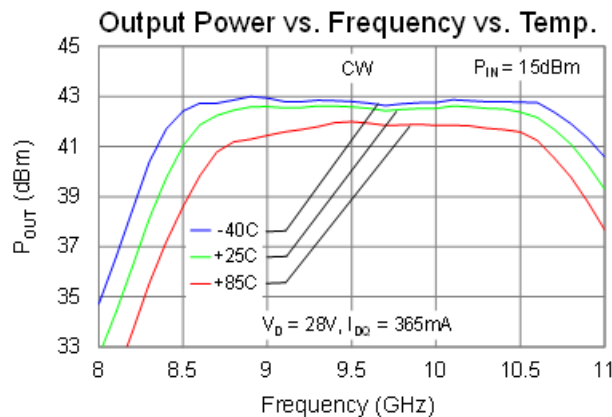
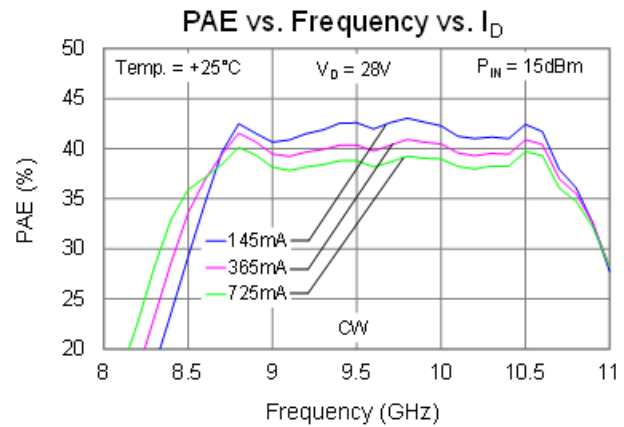
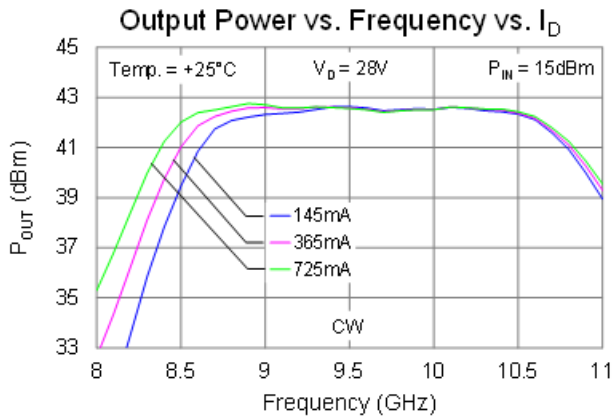
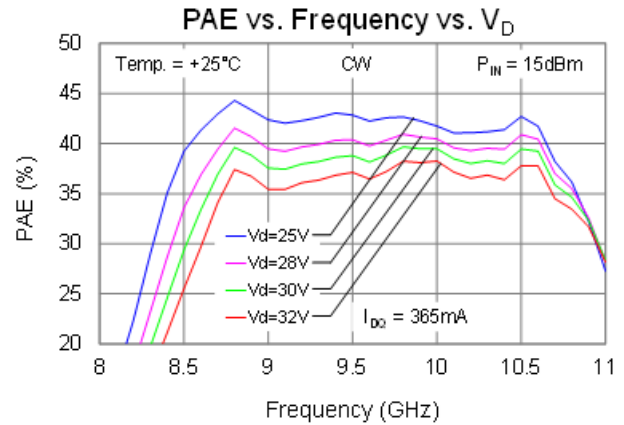
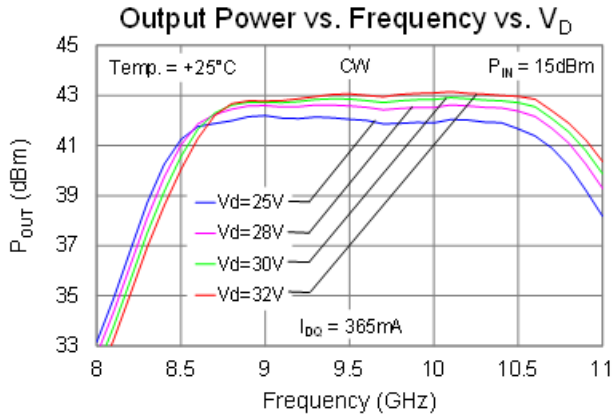

Performance Plots – Large Signal (CW)

Test conditions unless otherwise noted: 25 °C, $V_D = 28\text{ V}$, $I_{DQ} = 365\text{ mA}$, CW

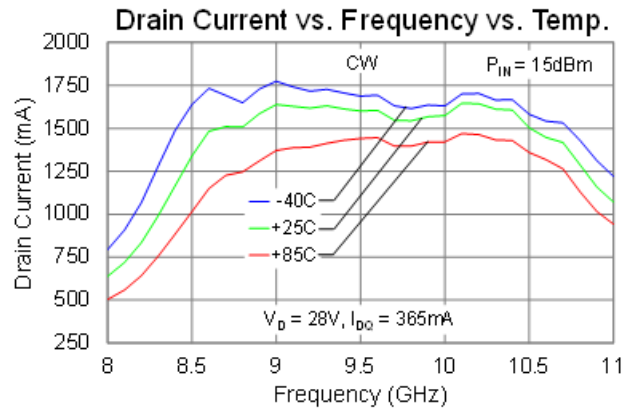
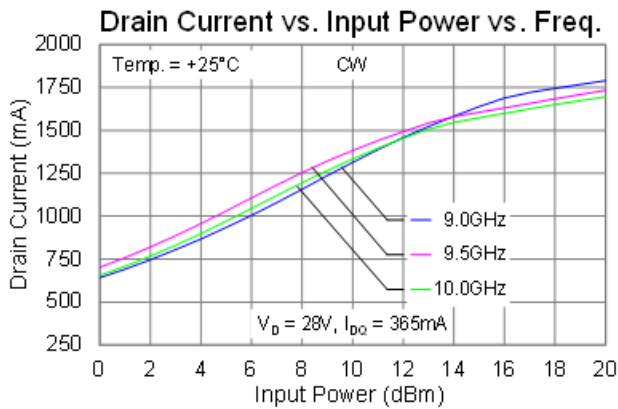
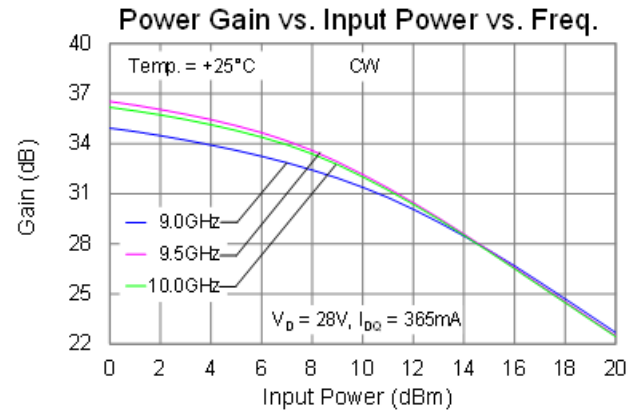
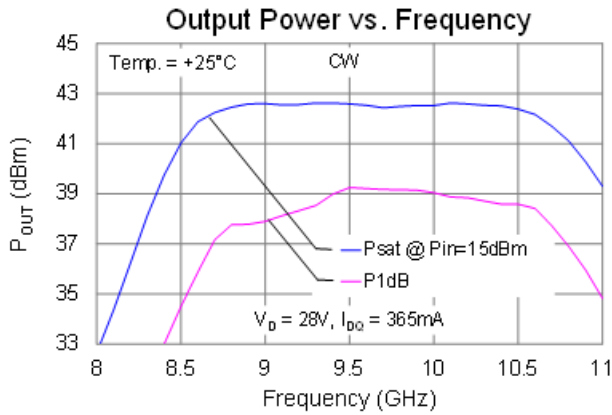
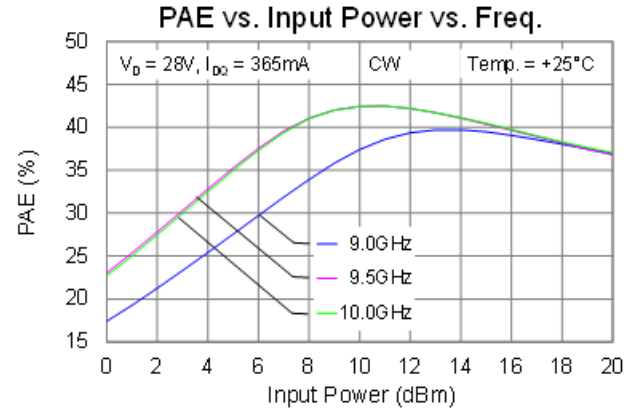
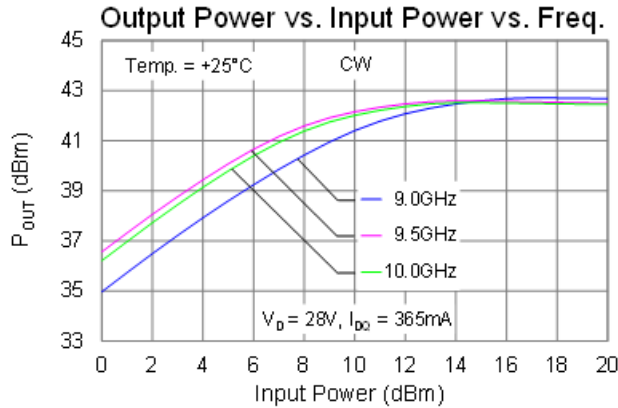

Performance Plots – Linearity

Test conditions unless otherwise noted: 25 °C, $V_D = 28\text{ V}$, $I_{DQ} = 365\text{ mA}$, CW

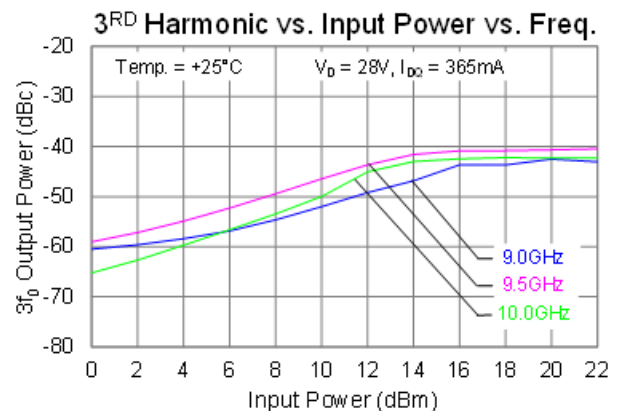
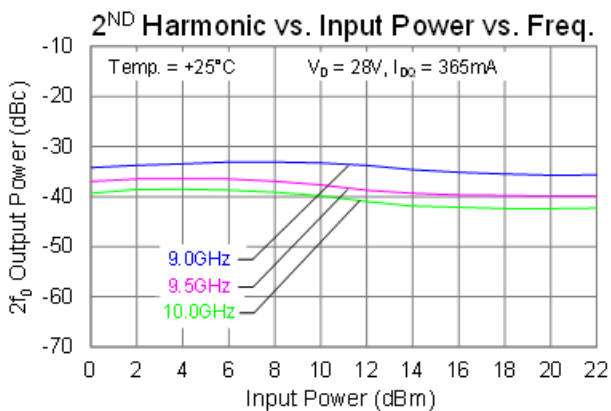
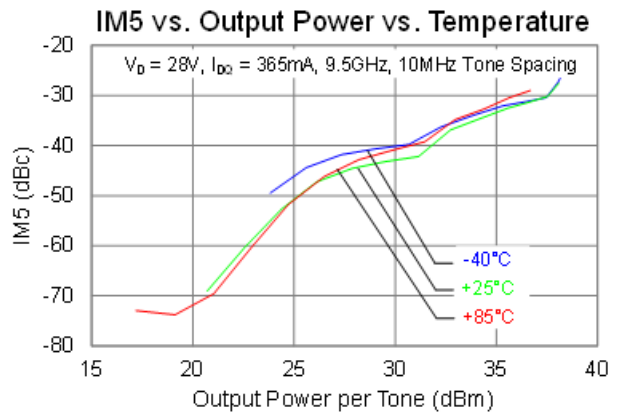
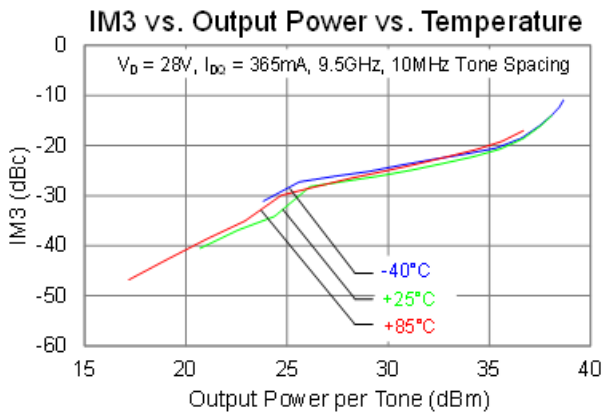
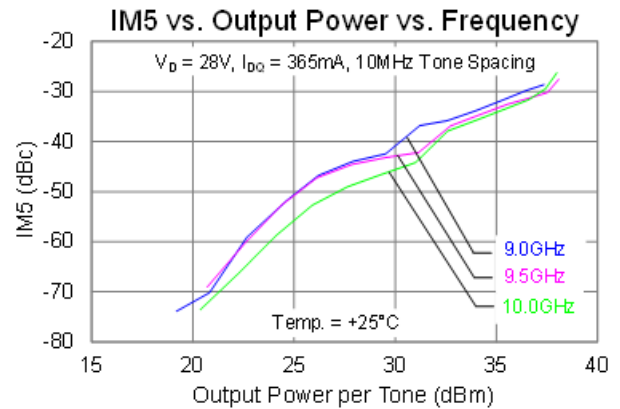
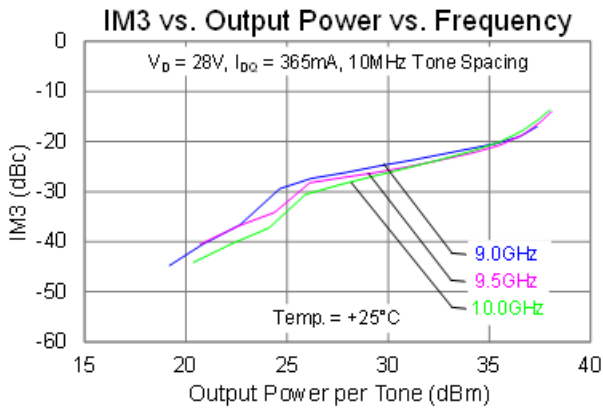

Performance Plots – Small Signal

Test conditions unless otherwise noted: 25 °C, $V_D = 28\text{ V}$, $I_{DQ} = 365\text{ mA}$, CW

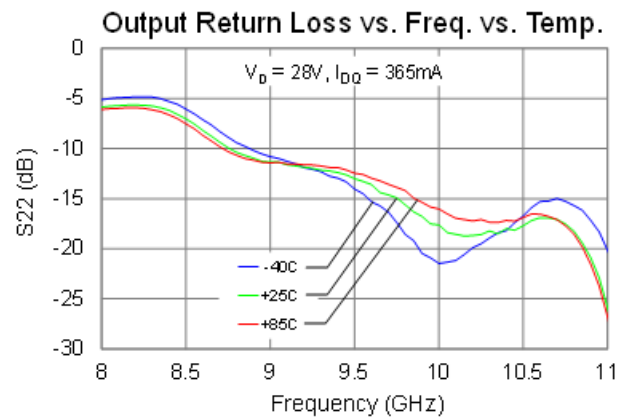
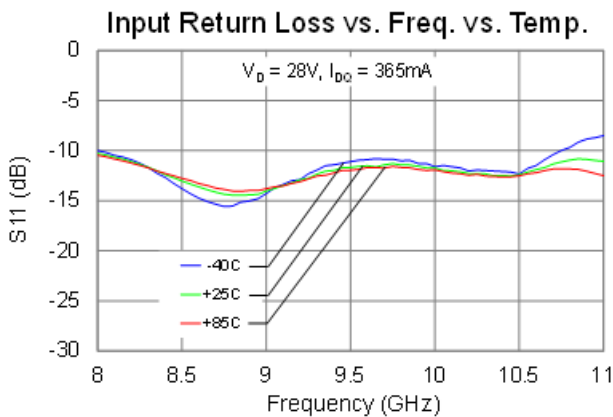
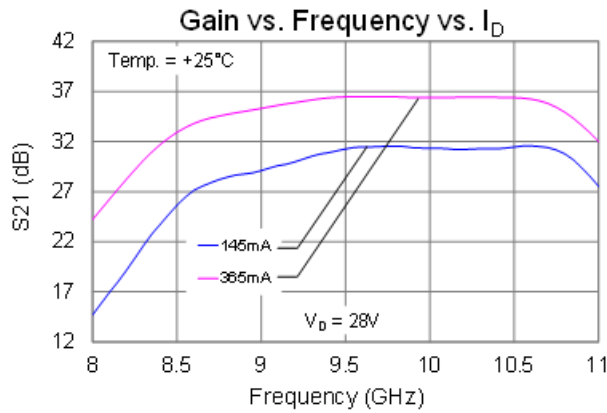
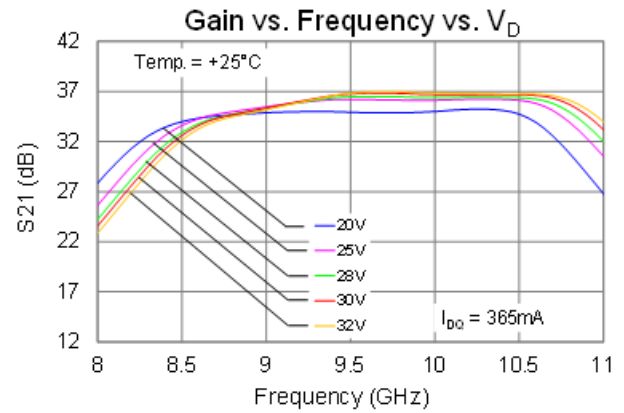
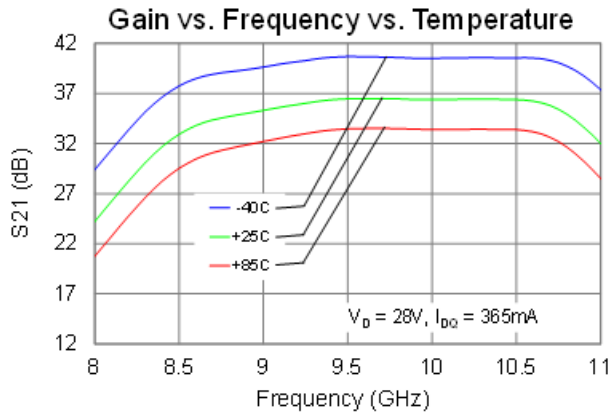

Thermal and Reliability Information

Parameter	Test Conditions	Value	Units
Thermal Resistance (θ_{JC}) ⁽¹⁾	$T_{base} = 85\text{ }^{\circ}\text{C}$, Pulsed V_D : PW = 100 us, DC = 10% (Quiescent; no RF)	2.372	$^{\circ}\text{C}/\text{W}$
Channel Temperature, T_{CH} (No RF) ⁽²⁾		109	$^{\circ}\text{C}$
Thermal Resistance (θ_{JC}) ⁽¹⁾	$T_{base} = 85\text{ }^{\circ}\text{C}$, Pulsed V_D $V_D = 28\text{ V}$, $I_{Drive} = 1.7\text{ A}$, $P_{IN} = 17\text{ dBm}$, $P_{OUT} = 43\text{ dBm}$, $P_{DISS} = 29\text{ W}$	1.804	$^{\circ}\text{C}/\text{W}$
Channel Temperature, T_{CH} (Under RF) ⁽²⁾		137	$^{\circ}\text{C}$
Thermal Resistance (θ_{JC}) ⁽¹⁾	$T_{base} = 85\text{ }^{\circ}\text{C}$, CW $V_D = 28\text{ V}$, $I_{Drive} = 1.55\text{ A}$, $P_{IN} =$ 17 dBm , $P_{OUT} = 42\text{ dBm}$, $P_{DISS} = 28\text{ W}$	2.596	$^{\circ}\text{C}/\text{W}$
Channel Temperature, T_{CH} (Under RF) ⁽²⁾		158	$^{\circ}\text{C}$

Notes:

- Thermal resistance determined to the back of 40 mil CuMo carrier plate (85 °C) with eutectic die attach
- IR scan equivalent. Refer to the following document: [GaN Device Channel Temperature, Thermal Resistance, and Reliability Estimates](#)

Dissipated Power and Maximum Gate Current

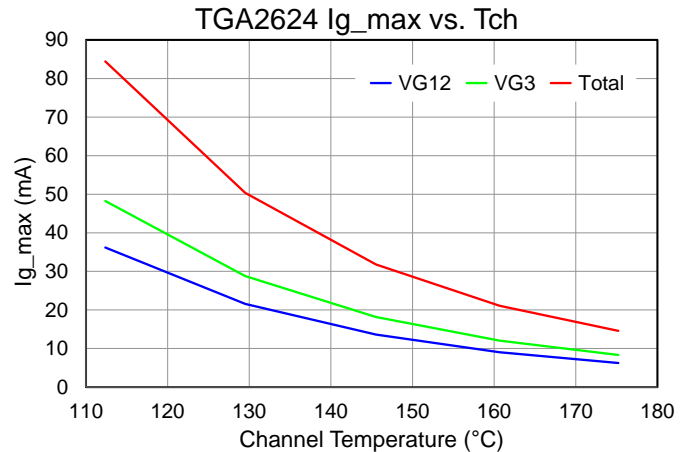
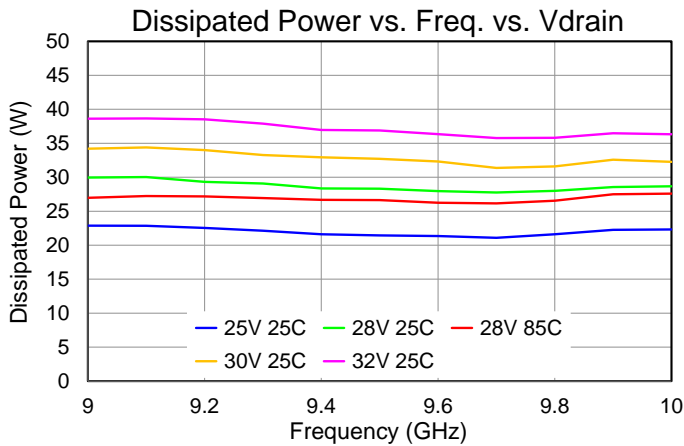

Test conditions, unless otherwise noted: $V_D = 28\text{ V}$, $I_{DQ} = 365\text{ mA}$, $T = +25\text{ }^{\circ}\text{C}$, $P_{IN} = 17\text{ dBm}$

Application Circuit

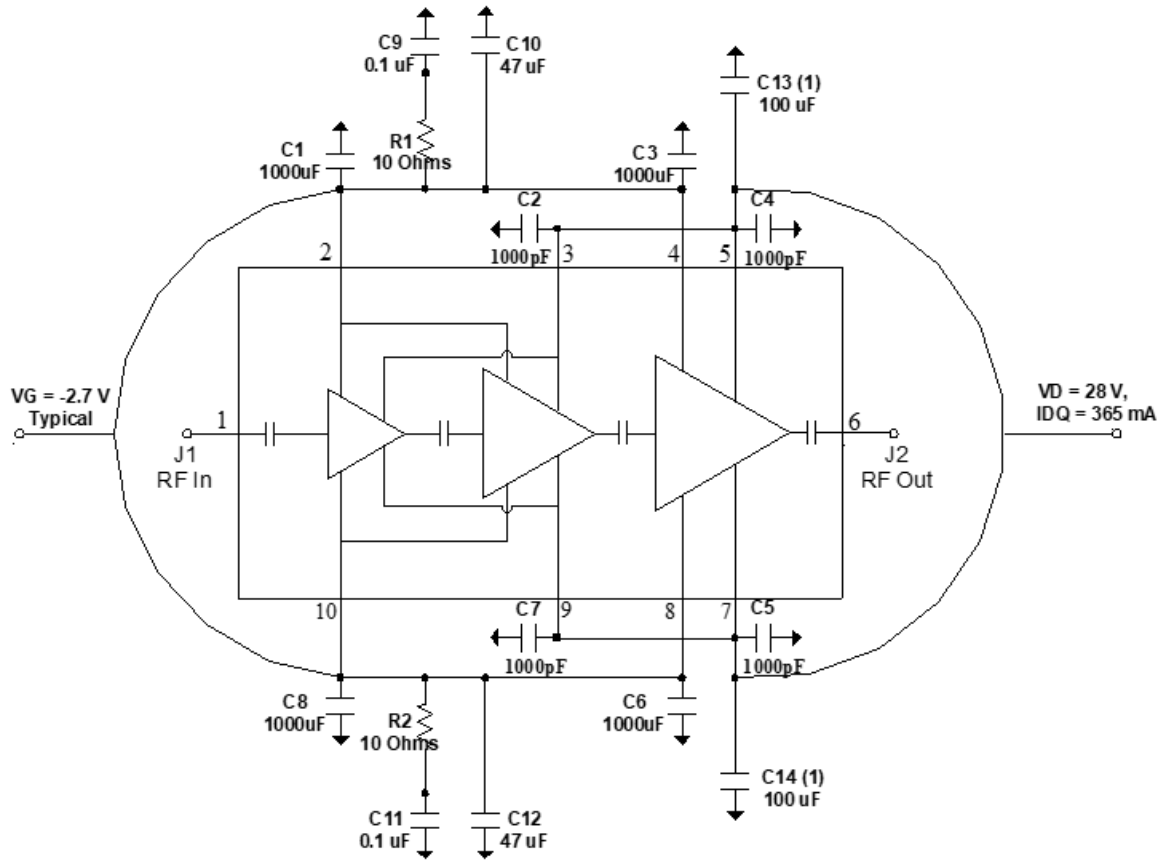

(1) Remove 100 uF capacitors (C13, C14) for pulsed operation.

Bias-Up Procedure

1. Set I_D limit to 1900 mA, I_G limit to 12 mA
2. Set V_G to -5.0 V
3. Set V_D +28 V
4. Adjust V_G more positive until $I_{DQ} \approx 365$ mA
5. Apply RF signal

Bias-Down Procedure

1. Turn off RF signal
2. Reduce V_G to -5.0 V. Ensure $I_{DQ} \sim 0$ mA
4. Set V_D to 0 V
5. Turn off V_D supply
6. Turn off V_G supply

Evaluation Board (EVB) Layout Assembly

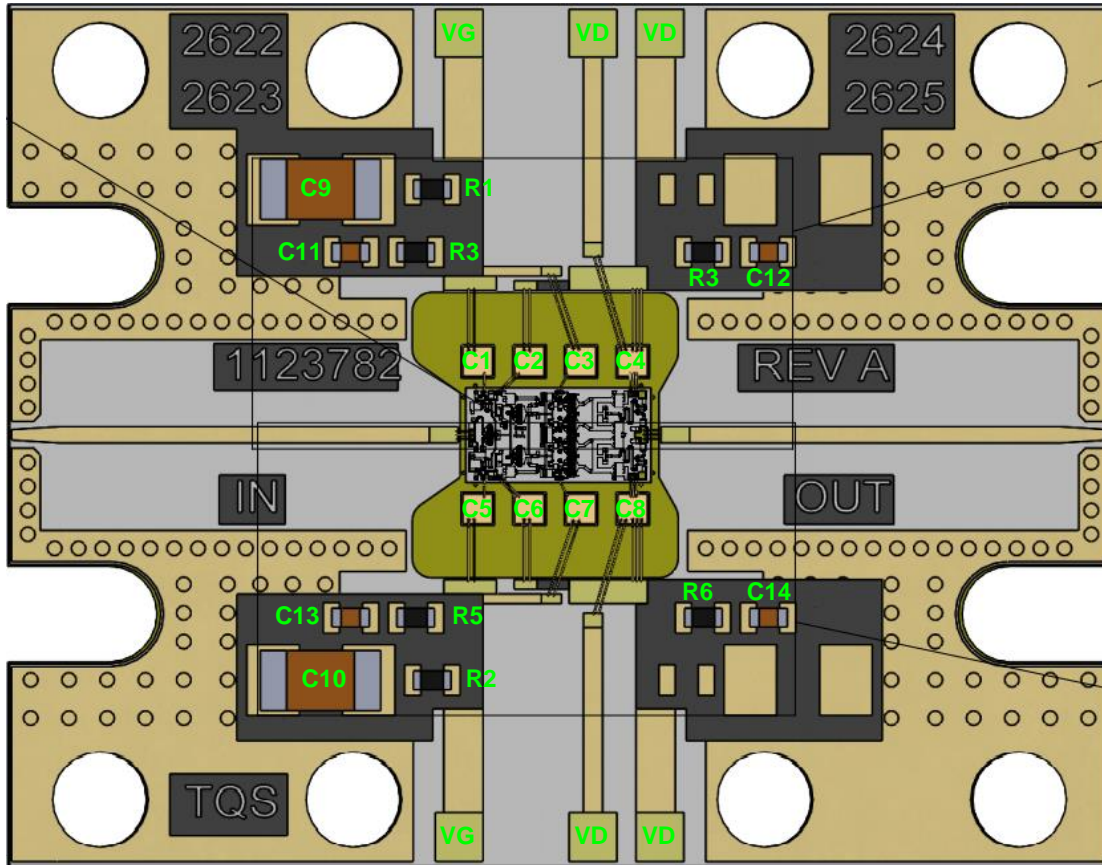

PCB is made from Rogers 4003C dielectric, .008 inch thick, 0.5 oz. copper both sides.

Bill of Materials

Reference Des.	Value	Description	Manuf.	Part Number
C1,C2,C3,C4,C5,C6,C7,C8	1000 pF	CAP, 1000 pF, ±10% 50V, BORDER, SL	Various	
C11,C12,C13,C14	0.1 uF	CAP, 0.1 uF, 10%, 50V, X7R, 0402	Various	
C9,C10	10 uF	CAP, 10 uF, +/-10%, 25V, X5R, 1206	Various	
R1,R2	0 Ω	RES, 0 OHM, JMPR, 0402	Various	
R3,R4,R5,R6	10 Ω	RES, 10 OHM, 5%, 0.1W, 0402	Various	
J1, J2	2.92 mm	RF Connector (F), 2.92 mm	SW Microwave	1092-01A-5

Mechanical Information

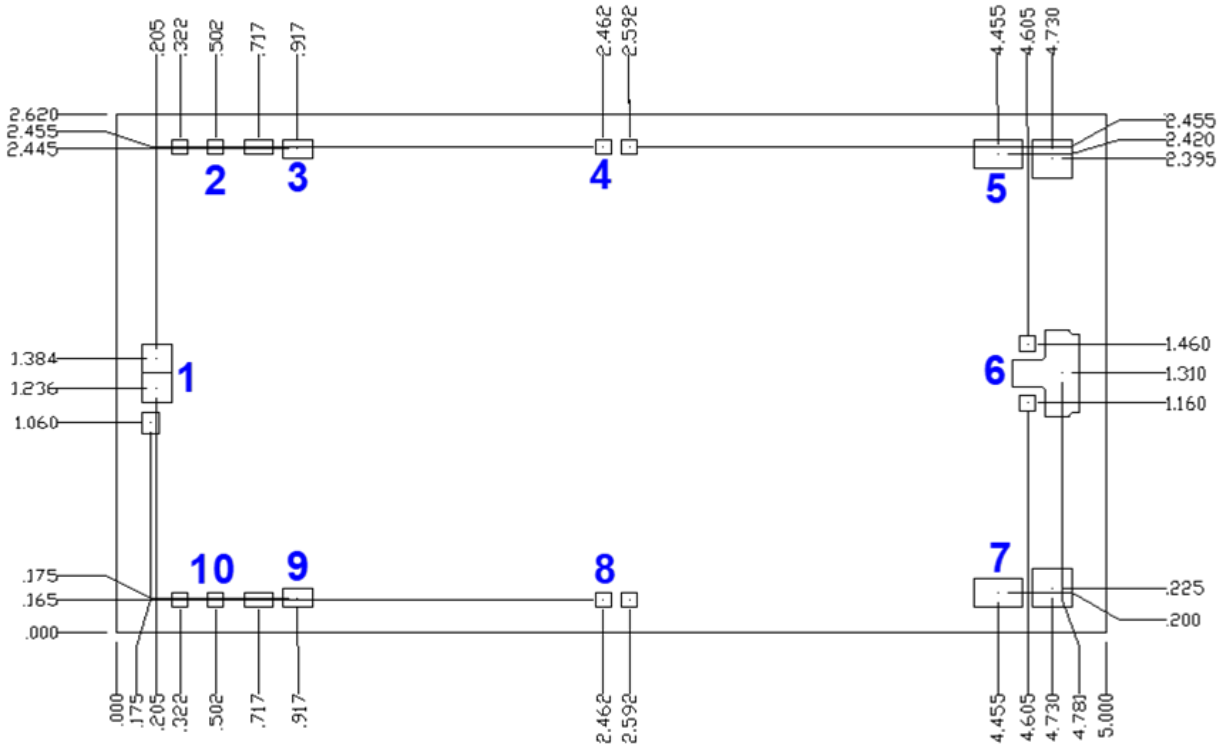

Dimensions are in mm
Thickness: 0.10
Die x, y size tolerance: ± 0.050
Ground is backside of die

Bond Pad Description

Pad No.	Symbol	Size ($\mu\text{m} \times \mu\text{m}$)	Description
1	RF In	0.150 x 0.300	RF Input; matched to 50 Ω ; DC Blocked
2, 8	V_{G1-2}	0.080 x 0.080	Gate voltage 1-2, bias network is required; see Application Circuit on page 10 as an example.
3, 9	V_{D1-2}	0.150 x 0.100	Drain voltage 1-2, bias network is required; see Application Circuit on page 10 as an example.
4, 10	V_{G3}	0.080 x 0.080	Gate voltage 3, bias network is required; see Application Circuit on page 10 as an example.
5, 7	V_{D3}	0.250 x 0.150	Drain voltage 3, bias network is required; see Application Circuit on page 10 as an example.
6	RF Out	0.180 x 0.350	RF Output; matched to 50 Ω ; DC Blocked

Assembly Notes

Component placement and adhesive attachment assembly notes:

- Vacuum pencils and/or vacuum collets are the preferred method of pick up.
- Air bridges must be avoided during placement.
- The force impact is critical during auto placement.

Reflow process assembly notes:

- Use AuSn (80/20) solder and limit exposure to temperatures above 300 °C to 3–4 minutes, maximum.
- An alloy station or conveyor furnace with reducing atmosphere should be used.
- Do not use any kind of flux.
- Coefficient of thermal expansion matching is critical for long-term reliability.
- Devices must be stored in a dry nitrogen atmosphere.

Interconnect process assembly notes:

- Thermosonic ball bonding is the preferred interconnect technique.
- Force, time, and ultrasonic are critical parameters.
- Aluminum wire should not be used.
- Devices with small pad sizes should be bonded with 0.0007-inch wire.

Handling Precautions

Parameter	Rating	Standard
ESD – Human Body Model (HBM)	0B	JEDEC JESD22-A114



Caution!

ESD-Sensitive Device

Solderability

Use only AuSn (80/20) solder, and limit exposure to temperatures above 300 °C to 3–4 minutes, maximum.

RoHS Compliance

This part is compliant with 2011/65/EU RoHS directive (Restrictions on the Use of Certain Hazardous Substances in Electrical and Electronic Equipment) as amended by Directive 2015/863/EU.

This product also has the following attributes:

- Lead Free
- Halogen Free (Chlorine, Bromine)
- Antimony Free
- TBBP-A (C₁₅H₁₂Br₄O₂) Free
- PFOS Free
- SVHC Free

Contact Information

For the latest specifications, additional product information, worldwide sales and distribution locations:

Web: www.qorvo.com

Tel: 1-844-890-8163

Email: customer.support@qorvo.com

Important Notice

The information contained herein is believed to be reliable; however, Qorvo makes no warranties regarding the information contained herein and assumes no responsibility or liability whatsoever for the use of the information contained herein. All information contained herein is subject to change without notice. Customers should obtain and verify the latest relevant information before placing orders for Qorvo products. The information contained herein or any use of such information does not grant, explicitly or implicitly, to any party any patent rights, licenses, or any other intellectual property rights, whether with regard to such information itself or anything described by such information. **THIS INFORMATION DOES NOT CONSTITUTE A WARRANTY WITH RESPECT TO THE PRODUCTS DESCRIBED HEREIN, AND QORVO HEREBY DISCLAIMS ANY AND ALL WARRANTIES WITH RESPECT TO SUCH PRODUCTS WHETHER EXPRESS OR IMPLIED BY LAW, COURSE OF DEALING, COURSE OF PERFORMANCE, USAGE OF TRADE OR OTHERWISE, INCLUDING THE IMPLIED WARRANTIES OF MERCHANTABILITY AND FITNESS FOR A PARTICULAR PURPOSE.**

Without limiting the generality of the foregoing, Qorvo products are not warranted or authorized for use as critical components in medical, life-saving, or life-sustaining applications, or other applications where a failure would reasonably be expected to cause severe personal injury or death.

© 2021 Qorvo US, Inc. All rights reserved. This document is subject to copyright laws in various jurisdictions worldwide and may not be reproduced or distributed, in whole or in part, without the express written consent of Qorvo US, Inc.

Looking for pricing, stock, or lifecycle information?

Click below to explore more details on WIN SOURCE:

 [View TGA2624 on WIN SOURCE](#)

 [Qorvo US Inc. Information](#)

Optimize Your Supply Chain with WIN SOURCE Solutions

-  Global Sourcing Solution
-  Obsolete Management
-  Cost Control Management
-  Shortage Management
-  Alternative Solution
-  Excess Inventory Management