



GaAs pHEMT MMIC LOW NOISE AMPLIFIER, 2 - 20 GHz

Typical Applications

The HMC462LP5 / HMC462LP5E Wideband LNA is ideal for:

- Telecom Infrastructure
- Microwave Radio & VSAT
- Military EW, ECM & C³I
- Test Instrumentation
- Fiber Optics

Features

- Noise Figure: 2.5 dB @ 10 GHz
- Gain: 13 dB
- P1dB Output Power: +14.5 dBm @ 10 GHz
- Self-Biased: +5V @ 66mA
- 50 Ohm Matched Input/Output
- 25 mm² Leadless SMT Package

Functional Diagram

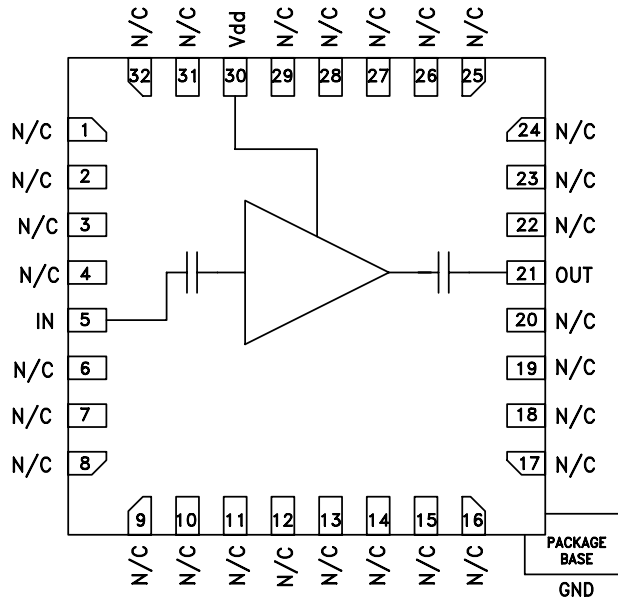

General Description

The HMC462LP5 & HMC462LP5E are GaAs MMIC pHEMT Low Noise Distributed Amplifiers in leadless 5x5 mm surface mount packages which operate between 2 and 20 GHz. The self-biased amplifier provides 13 dB of gain, 2.5 to 3.5 dB noise figure and +14.5 dBm of output power at 1 dB gain compression while requiring only 66 mA from a single +5V supply. Gain flatness is excellent from 6 - 18 GHz making the HMC462LP5 & HMC462LP5E ideal for EW, ECM RADAR and test equipment applications. The wideband amplifier I/Os are internally matched to 50 Ohms and are internally DC blocked.

Electrical Specifications, $T_A = +25^\circ C$, $V_{DD} = 5V$

Parameter	Min.	Typ.	Max.	Min.	Typ.	Max.	Min.	Typ.	Max.	Units
Frequency Range	2 - 6			6 - 14			14 - 20			GHz
Gain	12	14		11	13		10	12		dB
Gain Flatness		±0.5			±0.5			±0.5		dB
Gain Variation Over Temperature		0.015	0.025		0.02	0.03		0.03	0.04	dB/ °C
Noise Figure		3.0	4.0		2.5	4.0		4.0	6.0	dB
Input Return Loss		15			13			11		dB
Output Return Loss		12			12			8		dB
Output Power for 1 dB Compression (P1dB)	12	15		11	14		9	12		dBm
Saturated Output Power (Psat)		17			16			15		dBm
Output Third Order Intercept (IP3)		26			25			22		dBm
Supply Current (I _{DD}) (V _{DD} = 5V)	41	66	84	41	66	84	41	66	84	mA

Information furnished by Analog Devices is believed to be accurate and reliable. However, no responsibility is assumed by Analog Devices for its use, nor for any infringements of patents or other rights of third parties that may result from its use. Specifications subject to change without notice. No license is granted by implication or otherwise under any patent or patent rights of Analog Devices. Trademarks and registered trademarks are the property of their respective owners.

For price, delivery, and to place orders: Analog Devices, Inc., One Technology Way, P.O. Box 9106, Norwood, MA 02062-9106
Phone: 781-329-4700 • Order online at www.analog.com
Application Support: Phone: 1-800-ANALOG-D



**GAAS PHEMT MMIC
LOW NOISE AMPLIFIER, 2 - 20 GHz**

Gain & Return Loss

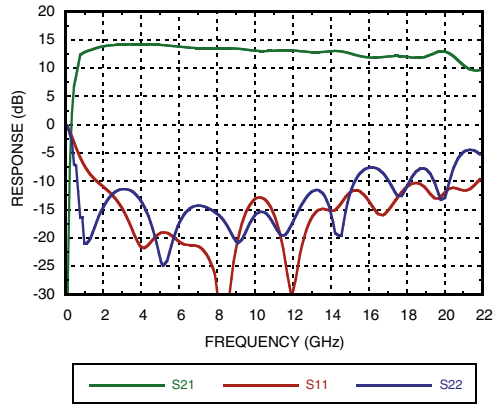

Gain vs. Temperature

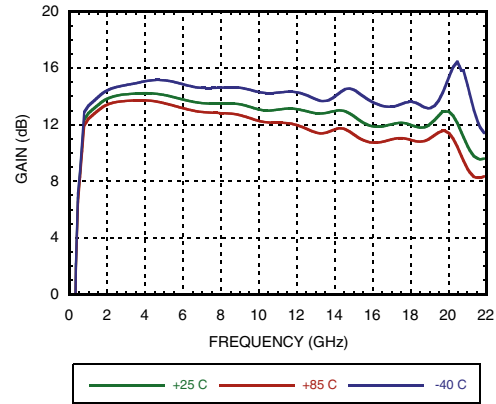

Input Return Loss vs. Temperature

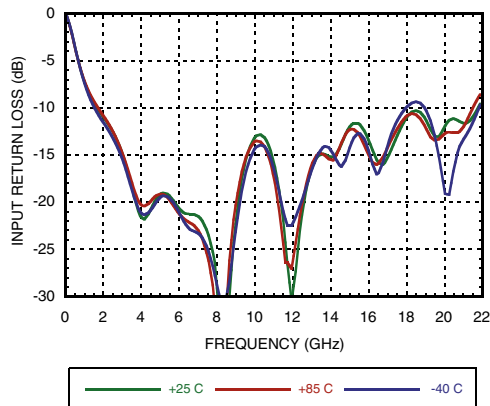

Output Return Loss vs. Temperature

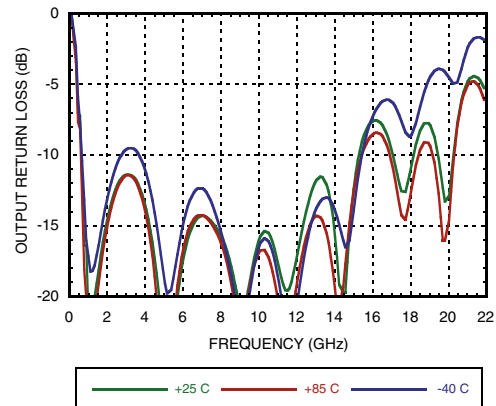

Reverse Isolation vs. Temperature

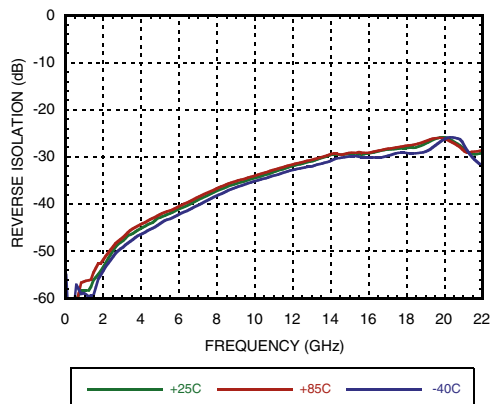

Noise Figure vs. Temperature

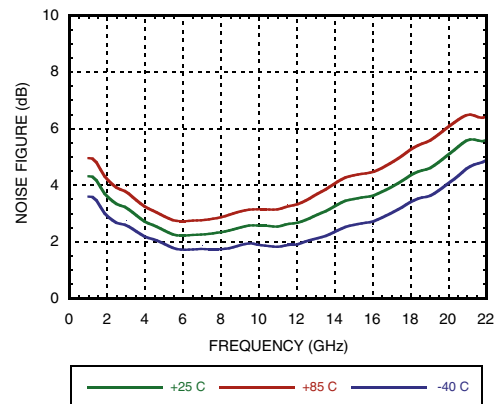

Information furnished by Analog Devices is believed to be accurate and reliable. However, no responsibility is assumed by Analog Devices for its use, nor for any infringements of patents or other rights of third parties that may result from its use. Specifications subject to change without notice. No license is granted by implication or otherwise under any patent or patent rights of Analog Devices. Trademarks and registered trademarks are the property of their respective owners.

For price, delivery, and to place orders: Analog Devices, Inc., One Technology Way, P.O. Box 9106, Norwood, MA 02062-9106 Phone: 781-329-4700 • Order online at www.analog.com Application Support: Phone: 1-800-ANALOG-D



**GAAS PHEMT MMIC
LOW NOISE AMPLIFIER, 2 - 20 GHz**

P1dB vs. Temperature

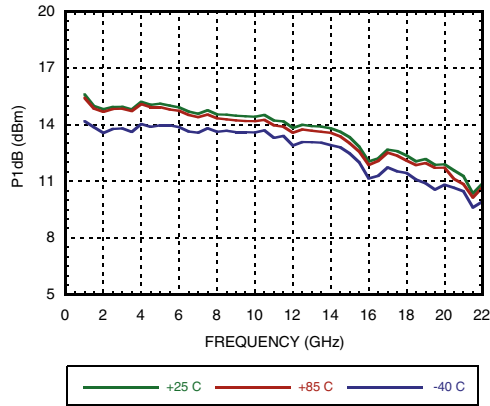

Psat vs. Temperature

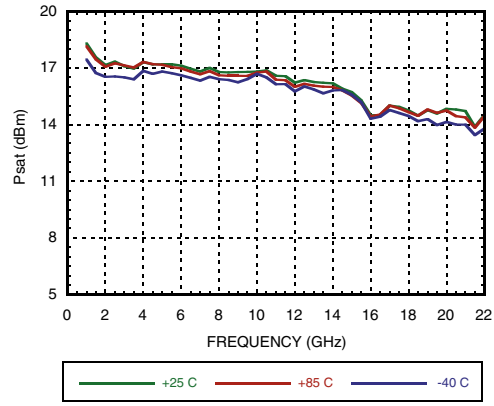

Output IP3 vs. Temperature

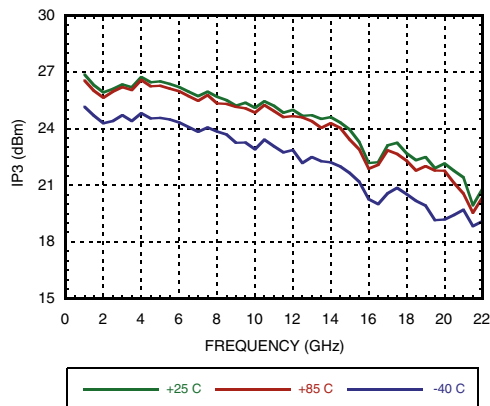

Gain, Power, Noise Figure & Supply Current vs. Supply Voltage @ 10 GHz

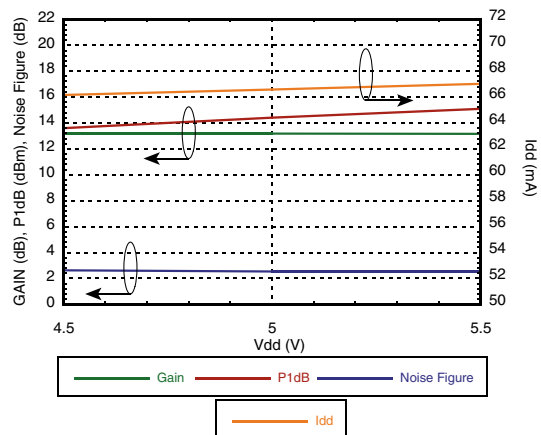

Absolute Maximum Ratings

Drain Bias Voltage (Vdd)	+9 Vdc
RF Input Power (RFIN)(Vdd = +5 Vdc)	+18 dBm
Channel Temperature	150 °C
Continuous Pdiss (T = 85 °C) (derate 50 mW/°C above 85 °C)	3.25 W
Thermal Resistance (channel to ground paddle)	52 °C/W
Storage Temperature	-65 to +150 °C
Operating Temperature	-40 to +85 °C

Typical Supply Current vs. Vdd

Vdd (V)	Idd (mA)
+4.5	66
+5.0	67
+5.5	68
+7.5	71
+8.0	72
+8.5	73



**ELECTROSTATIC SENSITIVE DEVICE
OBSERVE HANDLING PRECAUTIONS**

Information furnished by Analog Devices is believed to be accurate and reliable. However, no responsibility is assumed by Analog Devices for its use, nor for any infringements of patents or other rights of third parties that may result from its use. Specifications subject to change without notice. No license is granted by implication or otherwise under any patent or patent rights of Analog Devices. Trademarks and registered trademarks are the property of their respective owners.

For price, delivery, and to place orders: Analog Devices, Inc., One Technology Way, P.O. Box 9106, Norwood, MA 02062-9106
Phone: 781-329-4700 • Order online at www.analog.com
Application Support: Phone: 1-800-ANALOG-D



GAAS PHEMT MMIC LOW NOISE AMPLIFIER, 2 - 20 GHz

Outline Drawing

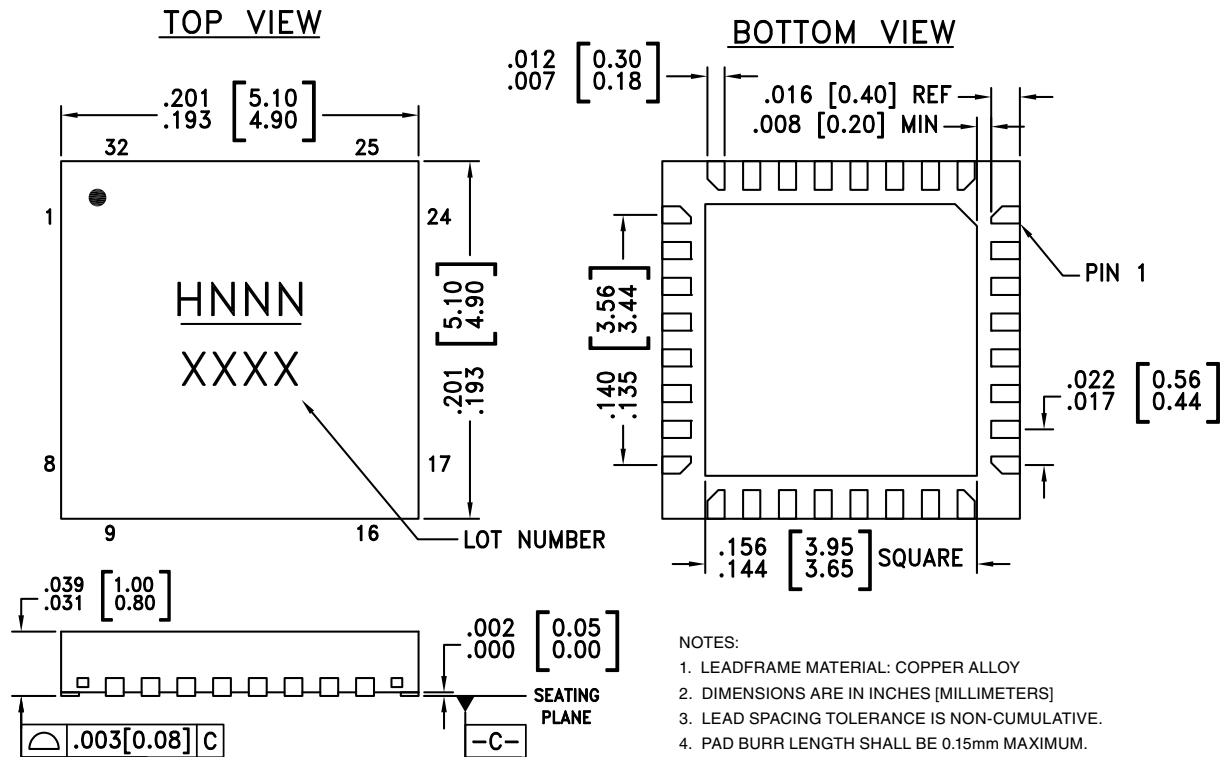

- NOTES:
1. LEADFRAME MATERIAL: COPPER ALLOY
 2. DIMENSIONS ARE IN INCHES [MILLIMETERS]
 3. LEAD SPACING TOLERANCE IS NON-CUMULATIVE.
 4. PAD BURR LENGTH SHALL BE 0.15mm MAXIMUM.
PAD BURR HEIGHT SHALL BE 0.05mm MAXIMUM.
 5. PACKAGE WARP SHALL NOT EXCEED 0.05mm.
 6. ALL GROUND LEADS AND GROUND PADDLE MUST BE SOLDERED TO PCB RF GROUND.
 7. REFER TO HITTITE APPLICATION NOTE FOR SUGGESTED LAND PATTERN.

Package Information

Part Number	Package Body Material	Lead Finish	MSL Rating	Package Marking ^[3]
HMC462LP5	Low Stress Injection Molded Plastic	Sn/Pb Solder	MSL1 ^[1]	H462 XXXX
HMC462LP5E	RoHS-compliant Low Stress Injection Molded Plastic	100% matte Sn	MSL1 ^[2]	H462 XXXX

[1] Max peak reflow temperature of 235 °C



[2] Max peak reflow temperature of 260 °C

[3] 4-Digit lot number XXXX

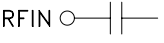
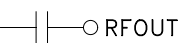
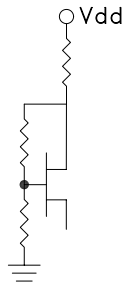

GaAs pHEMT MMIC LOW NOISE AMPLIFIER, 2 - 20 GHz

Pin Descriptions

Pin Number	Function	Description	Interface Schematic
1 - 4, 6 - 20, 22 - 29, 31, 32	N/C	No connection. These pins may be connected to RF ground. Performance will not be affected.	
5	RFIN	This pad is AC coupled and matched to 50 Ohms.	RFIN 
21	RFOUT	This pad is AC coupled and matched to 50 Ohms.	 RFOUT
30	Vdd	Power supply voltage for the amplifier. External bypass capacitors are required.	
Ground Paddle	GND	Ground paddle must be connected to RF/DC ground.	

GAAS PHEMT MMIC LOW NOISE AMPLIFIER, 2 - 20 GHz

Evaluation PCB

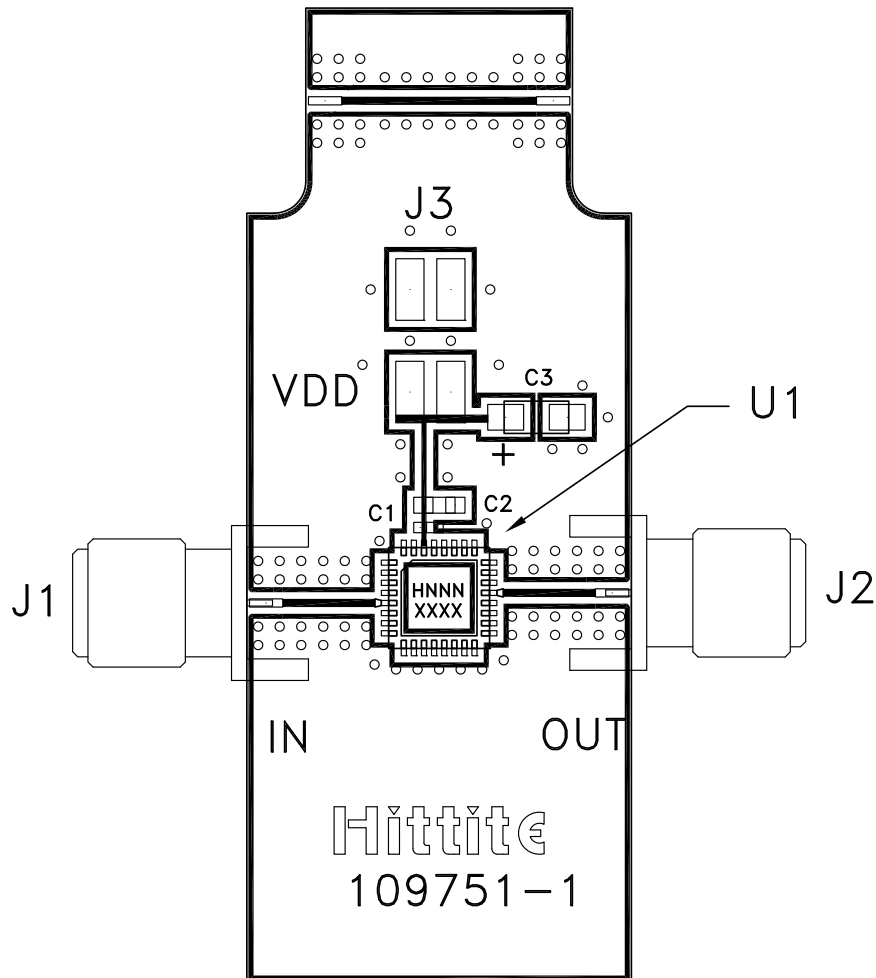

List of Materials for Evaluation PCB 108338 [1]

Item	Description
J1 - J2	PCB Mount SMA Connector
J3	2 mm Molex Header
C1	100 pF Capacitor, 0402 Pkg.
C2	1000 pF Capacitor, 0603 Pkg.
C3	4.7 μF Capacitor, Tantalum
U1	HMC462LP5 / HMC462LP5E
PCB [2]	109751 Evaluation PCB

[1] Reference this number when ordering complete evaluation PCB

[2] Circuit Board Material: Rogers 4350

The circuit board used in the application should use RF circuit design techniques. Signal lines should have 50 Ohm impedance while the package ground leads and package bottom should be connected directly to the ground plane similar to that shown. A sufficient number of via holes should be used to connect the top and bottom ground planes. The evaluation board should be mounted to an appropriate heat sink. The evaluation circuit board shown is available from Hittite upon request.

Looking for pricing, stock, or lifecycle information?

Click below to explore more details on WIN SOURCE:

 [View HMC462LP5TR on WIN SOURCE](#)

 [Analog Devices Inc. Information](#)

Optimize Your Supply Chain with WIN SOURCE Solutions

-  Global Sourcing Solution
-  Obsolete Management
-  Cost Control Management
-  Shortage Management
-  Alternative Solution
-  Excess Inventory Management