



Preliminary

# QPA2575

## 32 – 38 GHz 3 Watt Power Amplifier

### Product Overview

Qorvo's QPA2575 is a Ka-band power amplifier fabricated on Qorvo's QPHT15 0.15 um power pHEMT process. The QPA2575 operates from 32 to 38 GHz, providing 3 W of saturated power with 16 % power-added efficiency, and 19 dB small signal gain.

To simplify system integration, the QPA2575 is fully matched to 50 ohms with integrated DC blocking caps on both I/O ports. It is ideally suited to support both commercial and defense related opportunities.

The QPA2575 is 100% DC and RF tested on-wafer to ensure compliance to performance specifications.

Lead-free and RoHS compliant

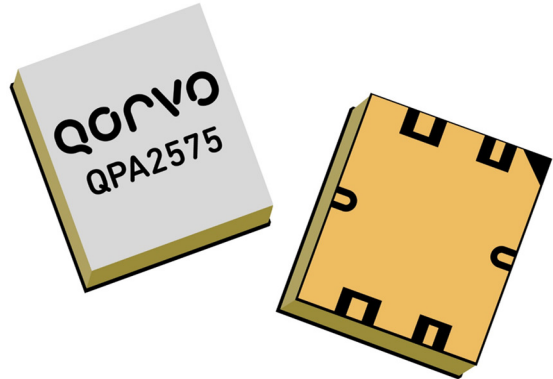

### Key Features

- Frequency Range: 32 – 38 GHz
- $P_{SAT}$  ( $P_{IN}=23$  dBm): 35 dBm
- PAE ( $P_{IN}=23$  dBm): 16 %
- Small Signal Gain: 19 dB
- Return Loss: 12 dB
- Bias: Pulsed  $V_D = 6$  V,  $I_{DQ} = 2.1$  A
- Package Dimensions: 7.0 x 8.0 x 1.465 mm

*Performance is typical across frequency. Please reference electrical specification table and data plots for more details.*

### Functional Block Diagram

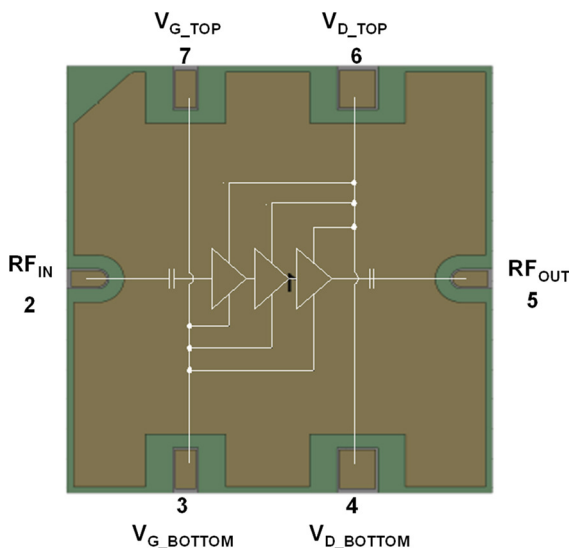

### Applications

- Radar
- Satellite Communications

### Ordering Information

Part No.	Description
QPA2575	32 - 38 GHz 3 Watt Power Amplifier
QPA2575TR7	250 pieces on a 7" reel
QPA2575EVB	Evaluation Board for QPA2575

## Absolute Maximum Ratings

Parameter	Value / Range
Drain Voltage ( $V_D$ )	6.5 V
Gate Voltage Range ( $V_G$ )	-5 to 0 V
Drain Current ( $I_D$ )	3.6 A
Gate Current ( $I_G$ )	-14 to 29 mA
Power Dissipation ( $P_{DISS}$ ), $T_{BASE} = 85^\circ\text{C}$	Pulsed, 22 W
	CW, 16 W
Input Power ( $P_{IN}$ ), 50 $\Omega$ , $V_D = 6$ V, $I_{DQ} = 2.1$ A, $T_{BASE} = 85^\circ\text{C}$	26 dBm
Input Power ( $P_{IN}$ ), 3:1 VSWR, $V_D = 6$ V, $I_{DQ} = 2.1$ A, $T_{BASE} = 85^\circ\text{C}$	26 dBm
Channel Temperature, $T_{CH}$	200 $^\circ\text{C}$
Mounting Temperature (30 seconds max)	260 $^\circ\text{C}$
Storage Temperature	-55 to 150 $^\circ\text{C}$

Operation of this device outside the parameter ranges given above may cause permanent damage. These are stress ratings only, and functional operation of the device at these conditions is not implied.

## Recommended Operating Conditions

Parameter	Min	Typ	Max	Units
Input Power ( $P_{IN}$ )*	19		23	dBm
Drain Voltage ( $V_D$ ); pulsed		6 **		V
Drain Current, Quiescent ( $I_{DQ}$ )		2.1		A
Drain Current, RF ( $I_{D\_Drive}$ )	See charts page 4, 8			A
Gate Voltage Typ. Range ( $V_G$ )	-0.35 to -0.85			V
Gate Current, RF ( $I_{G\_Drive}$ )	See charts page 4, 8			mA
Operating Temp. Range, $T_{BASE}$	-40	+25	+85	$^\circ\text{C}$

Electrical specifications are measured at specified test conditions. Specifications are not guaranteed over all recommended operating conditions.

\* Non-operating range: 8 – 18 dBm

\*\* Not recommended for CW due to thermal

## Electrical Specifications

Parameter	Conditions <sup>(1)</sup> <sup>(2)</sup>	Min	Typ	Max	Units
Operational Frequency Range		32		38	GHz
Output Power at Saturation, $P_{SAT}$	$P_{IN} = +23$ dBm, Frequency = 32 - 36 GHz		36		dBm
	$P_{IN} = +23$ dBm, Frequency = 37 - 38 GHz		35		
Power Added Efficiency, PAE	$P_{IN} = +23$ dBm, Frequency = 32 - 36 GHz		22		%
	$P_{IN} = +23$ dBm, Frequency = 37 - 38 GHz		16		
Small Signal Gain, $S_{21}$			> 19		dB
Input Return Loss, IRL			12		dB
Output Return Loss, ORL			12		dB
$P_{SAT}$ Temperature Coefficient	$T_{DIFF} = -40^\circ\text{C}$ to $+85^\circ\text{C}$ ; $P_{IN} = +23$ dBm		-0.009		dBm/ $^\circ\text{C}$
$S_{21}$ Temperature Coefficient	$T_{DIFF} = -40^\circ\text{C}$ to $+85^\circ\text{C}$		-0.04		dB/ $^\circ\text{C}$

Notes:

1. Test conditions unless otherwise noted: Pulsed  $V_D = 6$  V,  $I_{DQ} = 2.1$  A, adjusting  $V_G$  (typical -0.6V +/-), Pulse Width = 50  $\mu\text{s}$ , Duty Cycle = 35%, CW RF,  $T_{BASE} = +25^\circ\text{C}$ ,  $Z_0 = 50 \Omega$
2.  $T_{BASE}$  is back side of package

Performance Plots – Large Signal

Test conditions unless otherwise noted: Pulsed  $V_D = 6\text{ V}$ ,  $I_{DQ} = 2.1\text{ A}$ , CW  $P_{IN} = 23\text{ dBm}$ ,  $PW = 50\text{ }\mu\text{S}$ ,  $DC = 35\%$ ,  $T_{BASE} = +25\text{ }^\circ\text{C}$

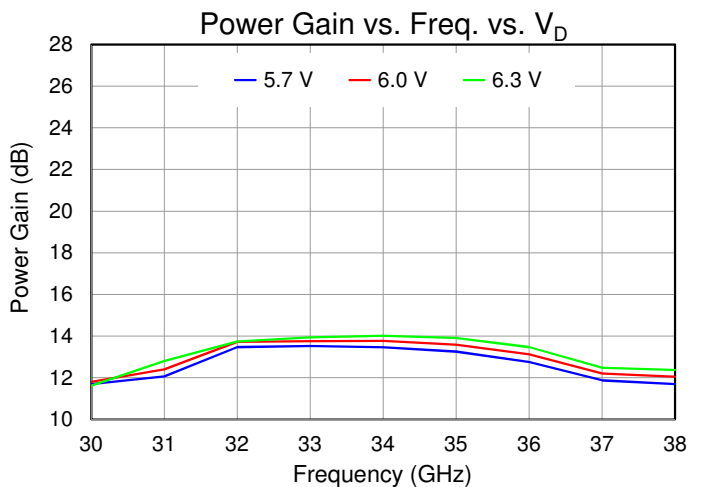
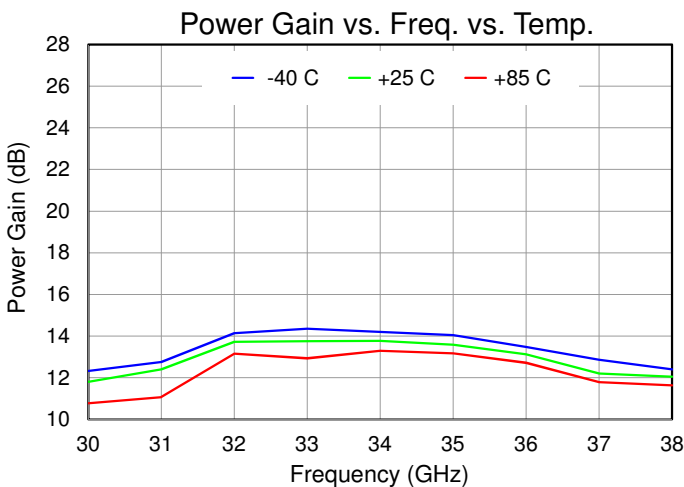
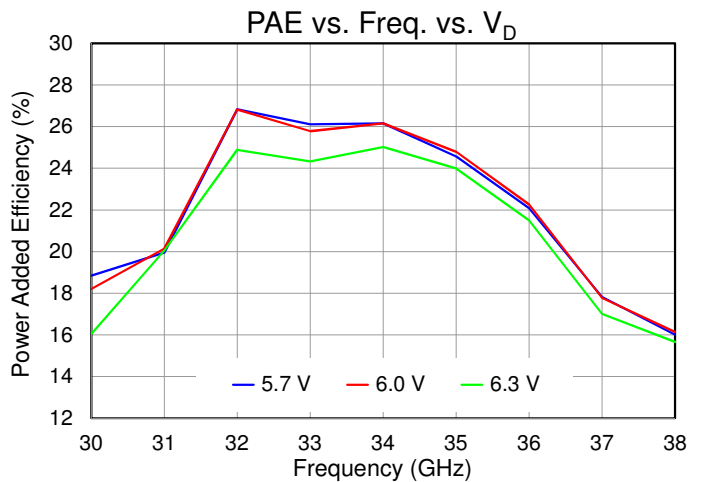
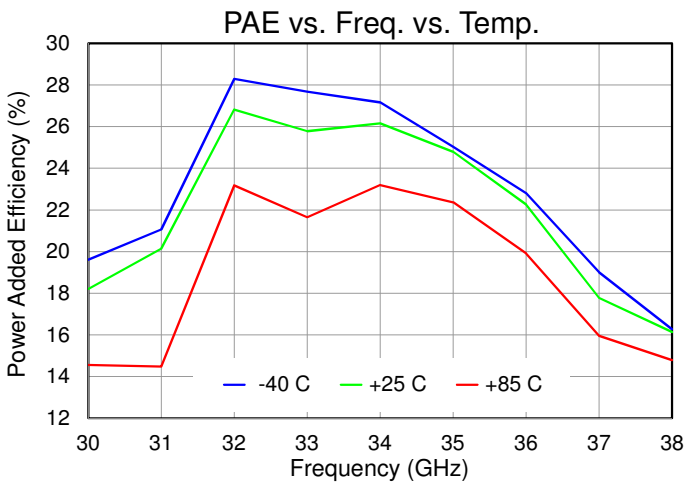
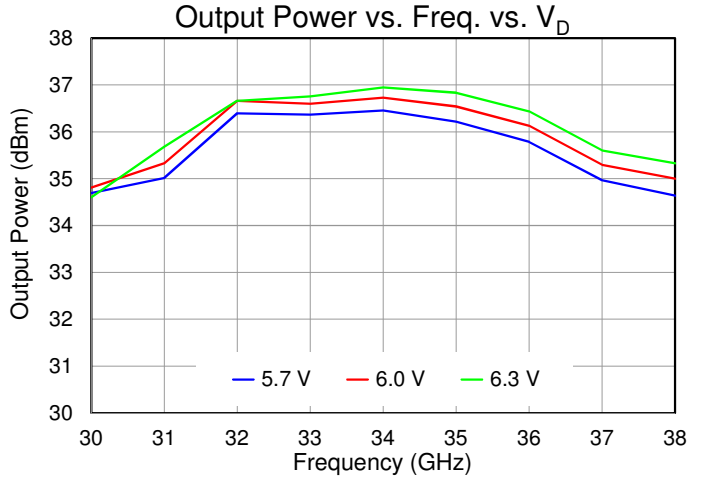
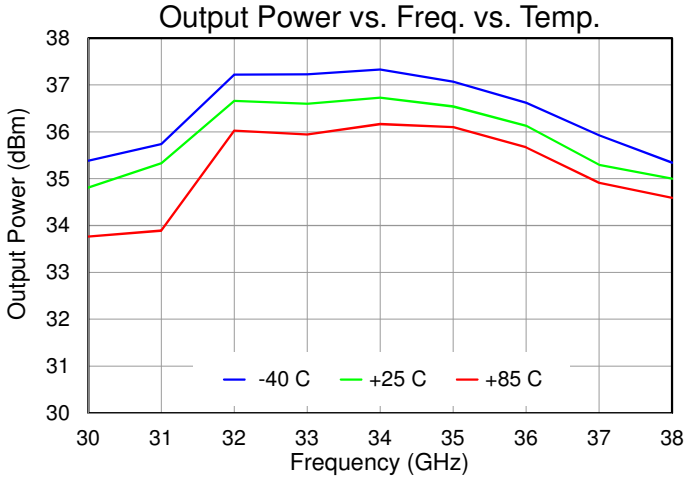

Performance Plots – Large Signal

Test conditions unless otherwise noted: Pulsed  $V_D = 6\text{ V}$ ,  $I_{DQ} = 2.1\text{ A}$ , CW  $P_{IN} = 23\text{ dBm}$ ,  $PW = 50\text{ }\mu\text{S}$ ,  $DC = 35\%$ ,  $T_{BASE} = +25\text{ }^\circ\text{C}$

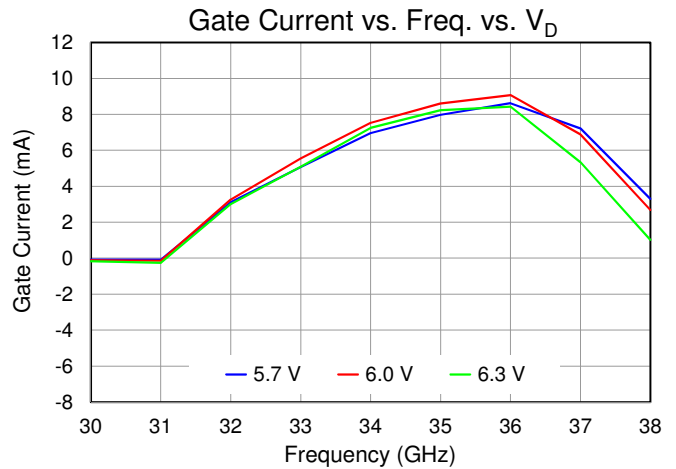
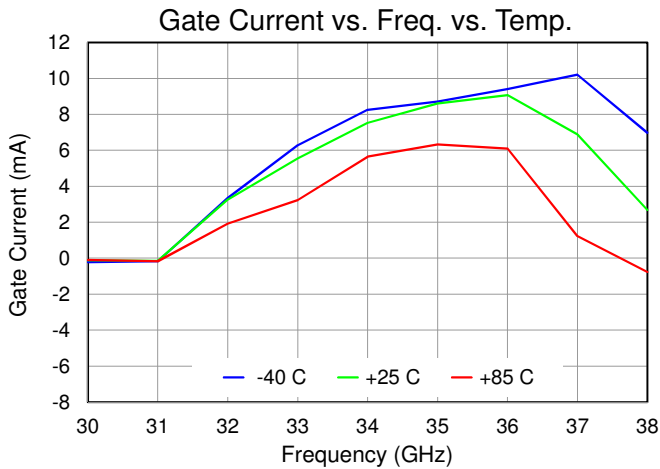
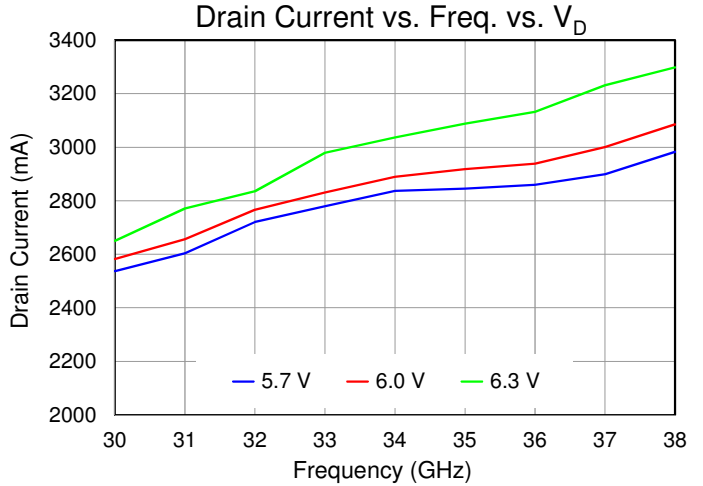
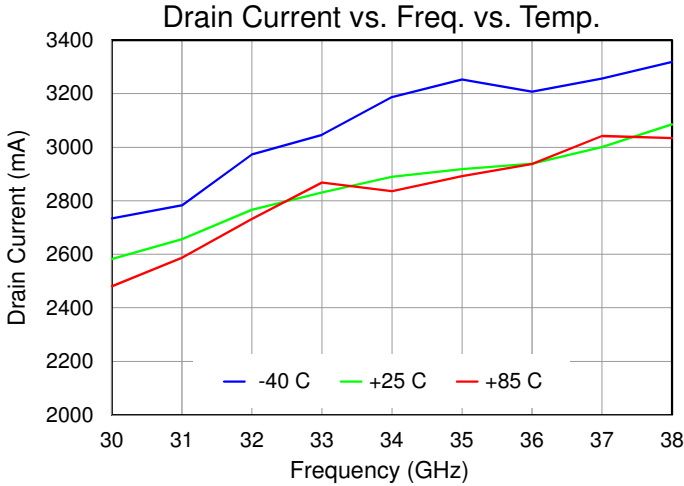

Performance Plots – Large Signal

Test conditions unless otherwise noted: Pulsed  $V_D = 6\text{ V}$ ,  $I_{DQ} = 2.1\text{ A}$ , CW  $P_{IN} = 23\text{ dBm}$ ,  $PW = 50\text{ }\mu\text{S}$ ,  $DC = 35\%$ ,  $T_{BASE} = +25\text{ }^\circ\text{C}$

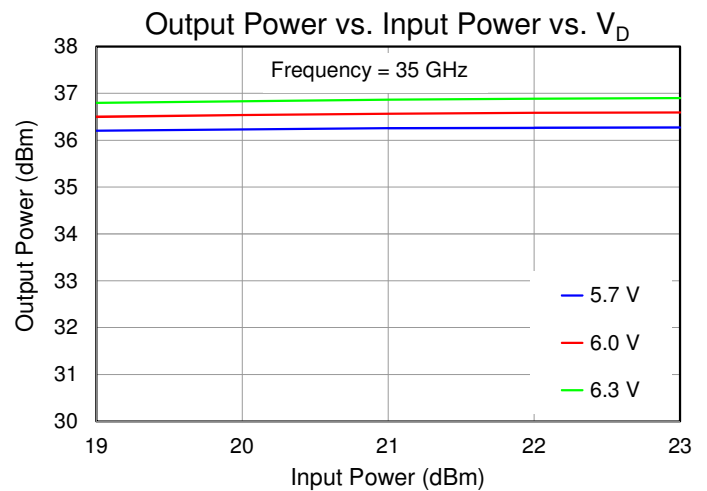
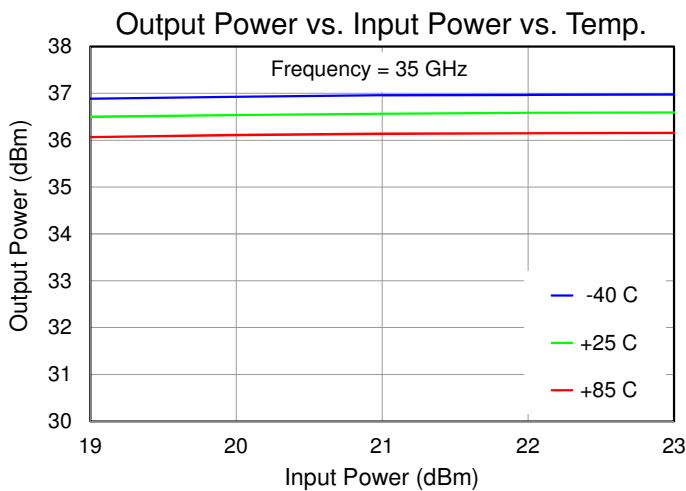
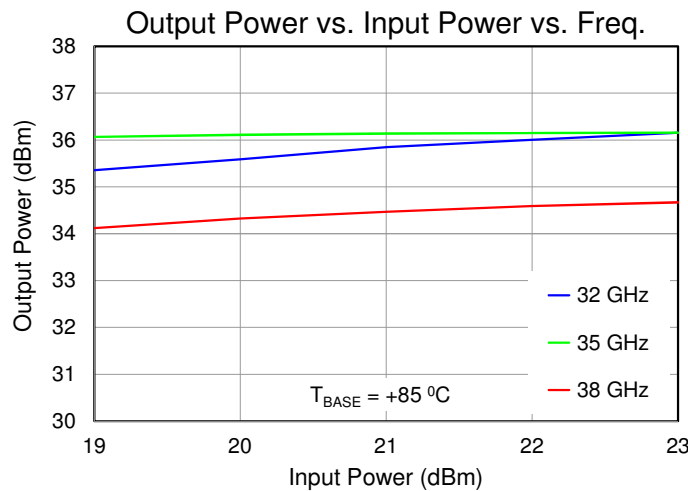
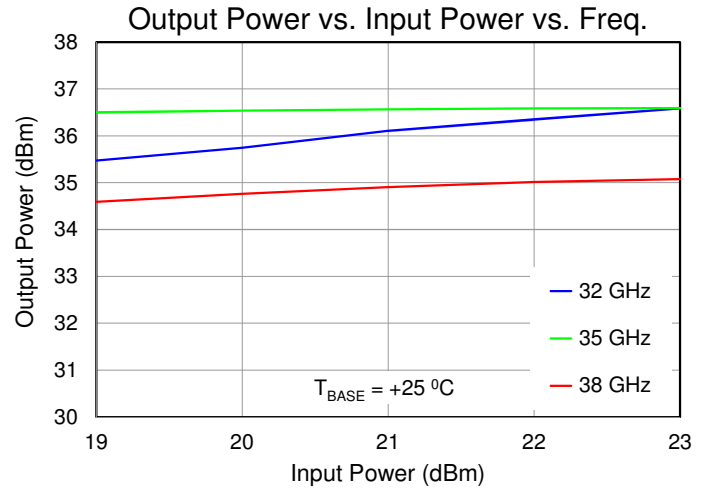
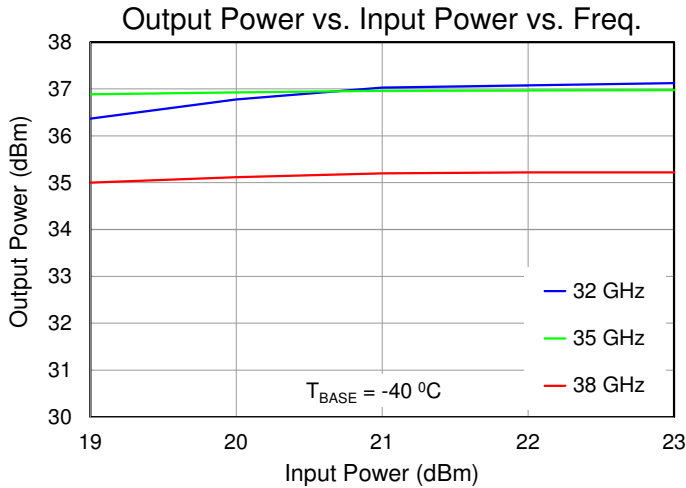

Performance Plots – Large Signal

Test conditions unless otherwise noted: Pulsed  $V_D = 6\text{ V}$ ,  $I_{DQ} = 2.1\text{ A}$ , CW  $P_{IN} = 23\text{ dBm}$ ,  $PW = 50\text{ }\mu\text{S}$ ,  $DC = 35\%$ ,  $T_{BASE} = +25\text{ }^\circ\text{C}$

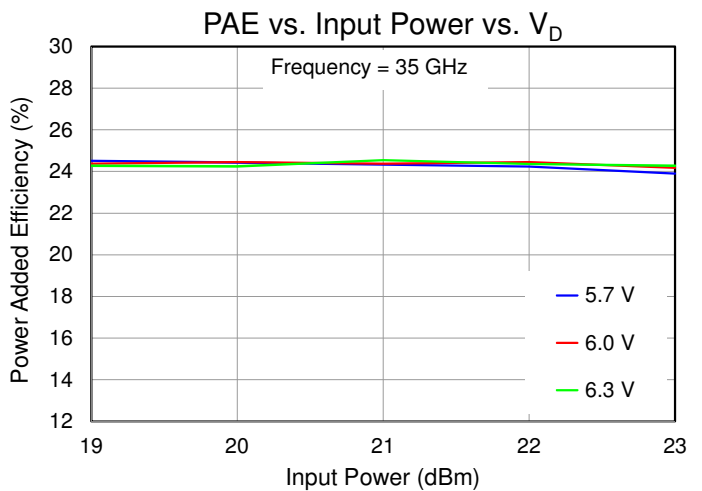
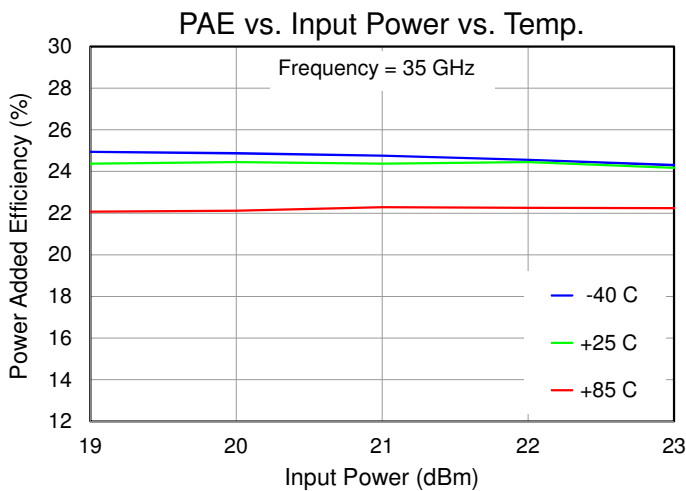
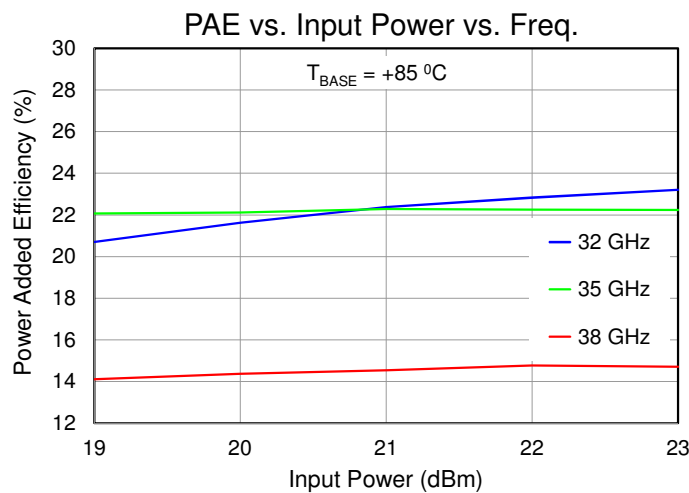
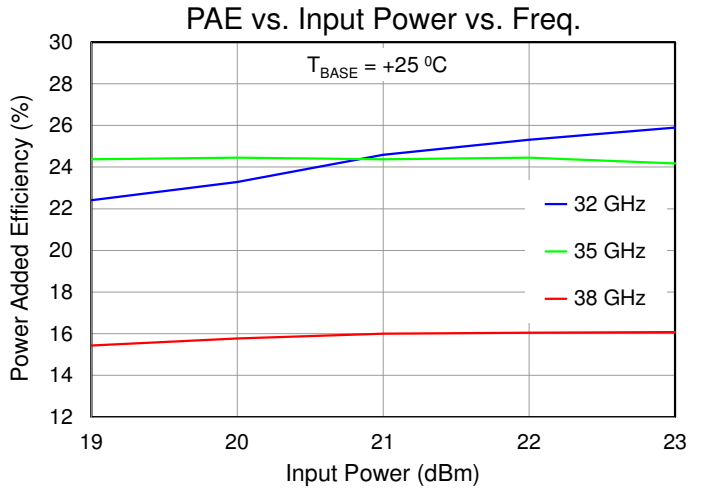
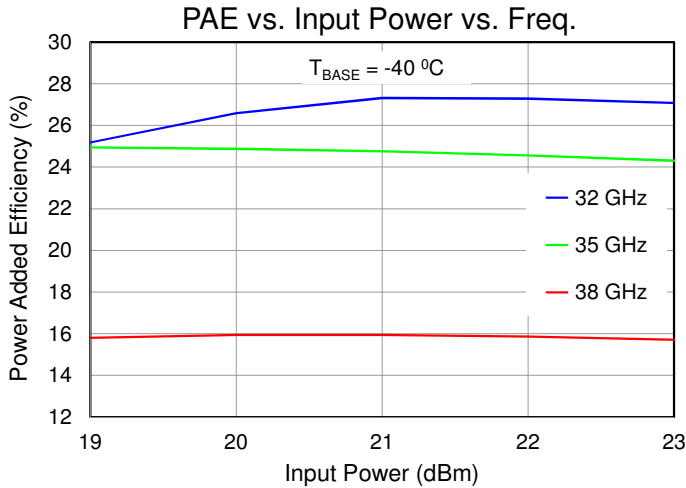

Performance Plots – Large Signal

Test conditions unless otherwise noted: Pulsed  $V_D = 6\text{ V}$ ,  $I_{DQ} = 2.1\text{ A}$ , CW  $P_{IN} = 23\text{ dBm}$ ,  $PW = 50\text{ }\mu\text{S}$ ,  $DC = 35\%$ ,  $T_{BASE} = +25\text{ }^\circ\text{C}$

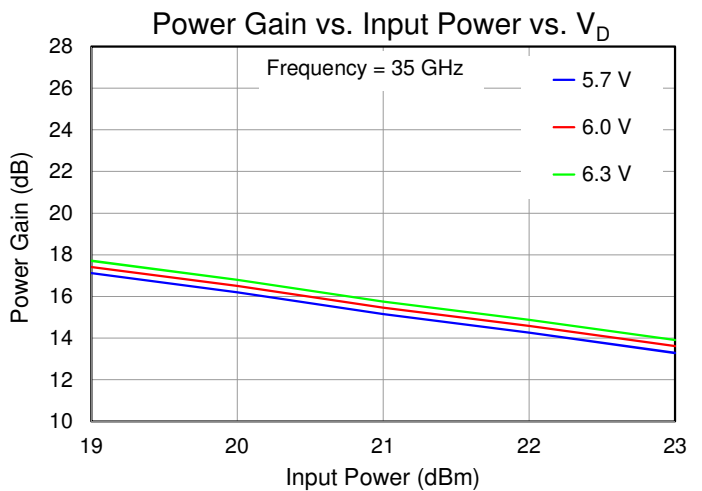
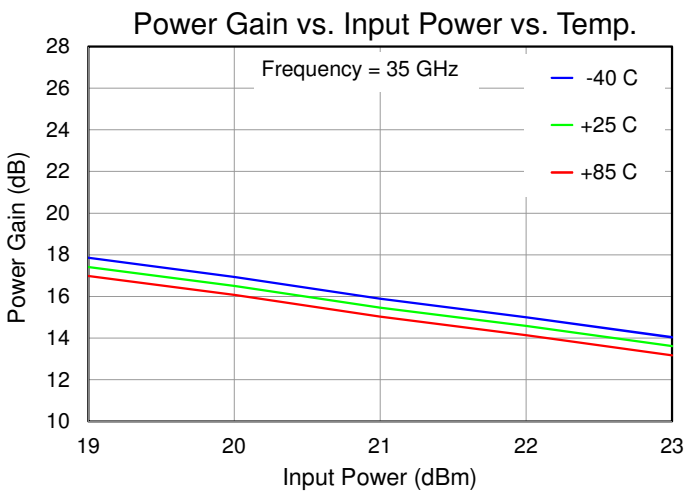
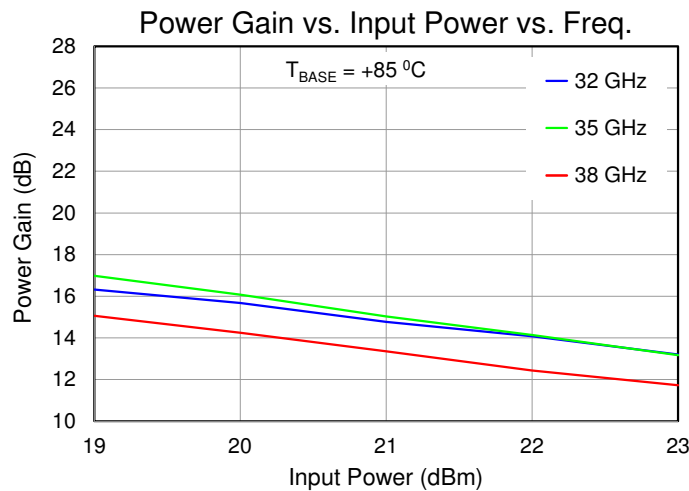
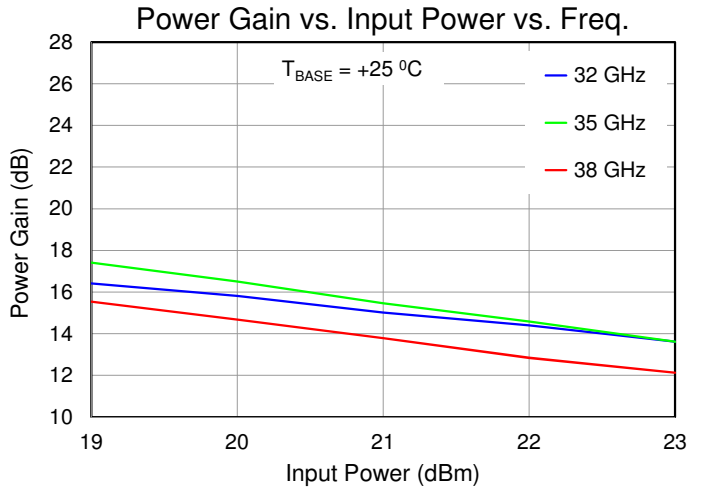
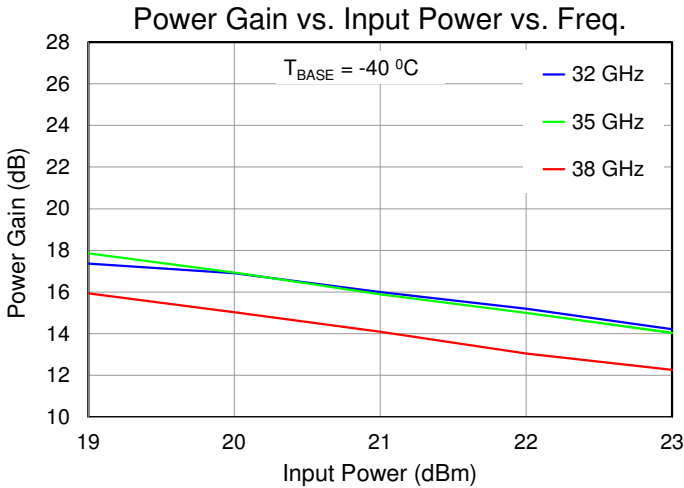

Performance Plots – Large Signal

Test conditions unless otherwise noted: Pulsed  $V_D = 6\text{ V}$ ,  $I_{DQ} = 2.1\text{ A}$ , CW  $P_{IN} = 23\text{ dBm}$ ,  $PW = 50\text{ }\mu\text{S}$ ,  $DC = 35\%$ ,  $T_{BASE} = +25\text{ }^\circ\text{C}$

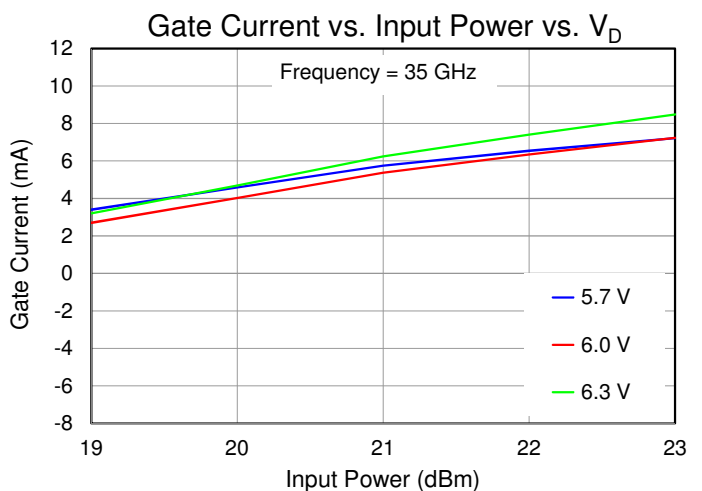
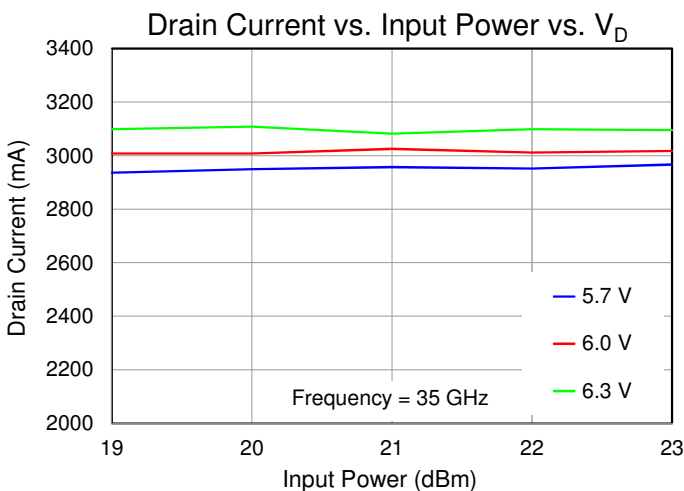
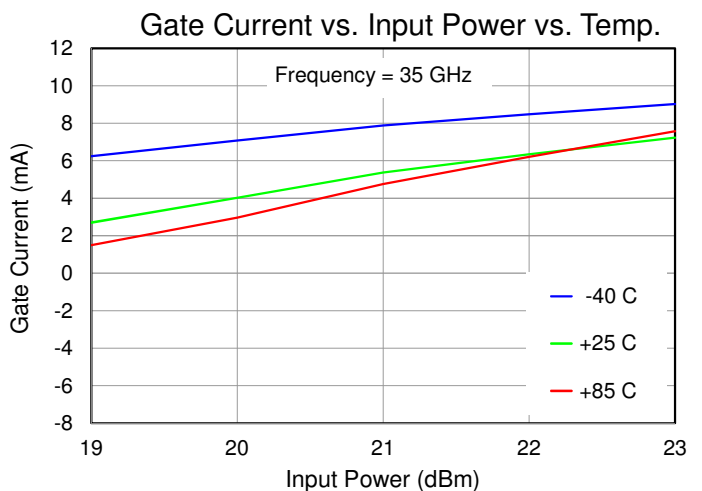
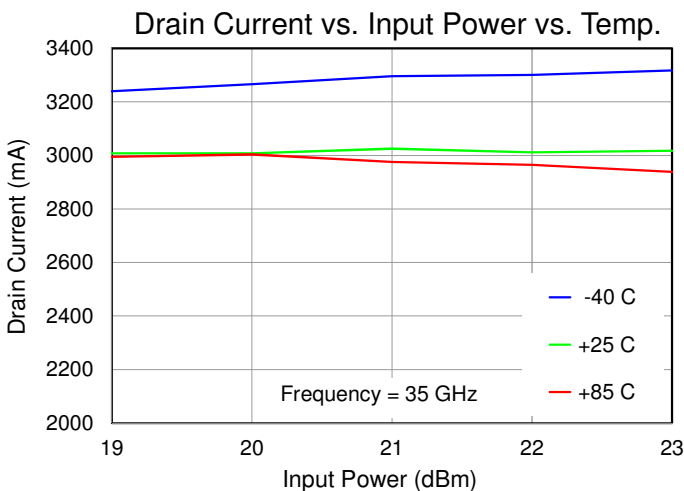
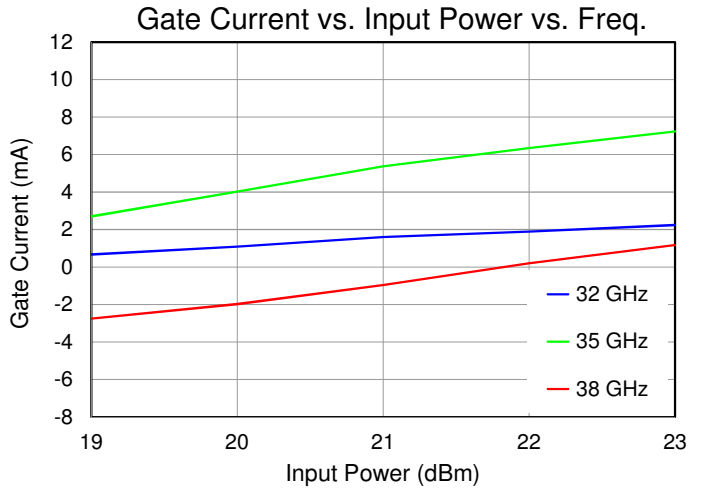
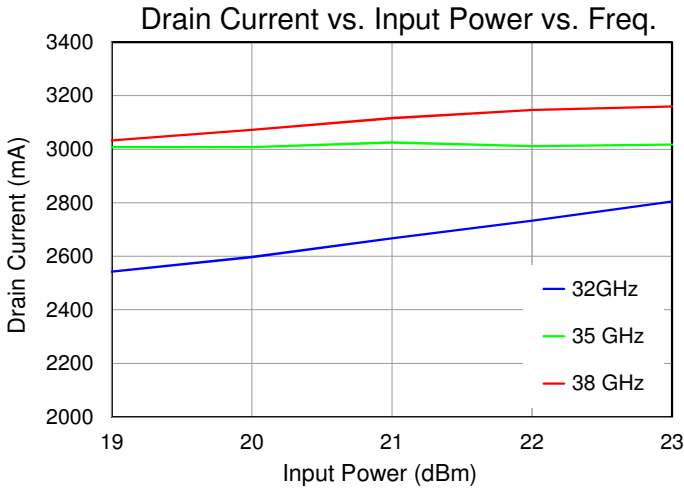

**Performance Plots – Small Signal**

Test conditions unless otherwise noted: CW,  $V_D = 6\text{ V}$ ,  $I_{DQ} = 2.1\text{ A}$ ,  $P_{IN} = -20\text{ dBm}$ ,  $T_{BASE} = +25\text{ }^\circ\text{C}$

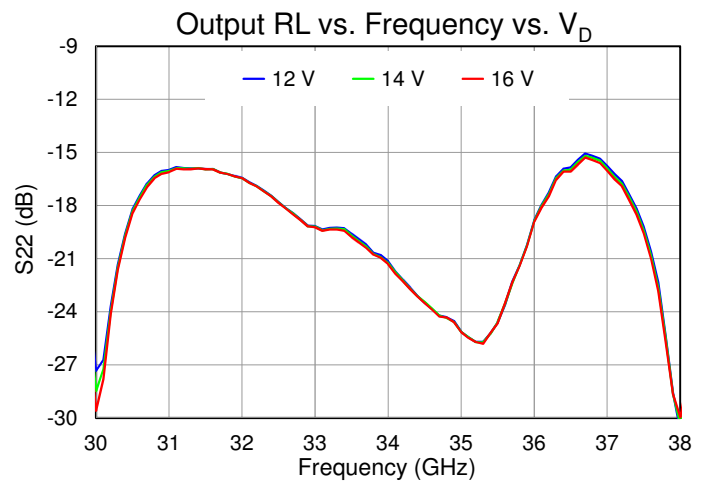
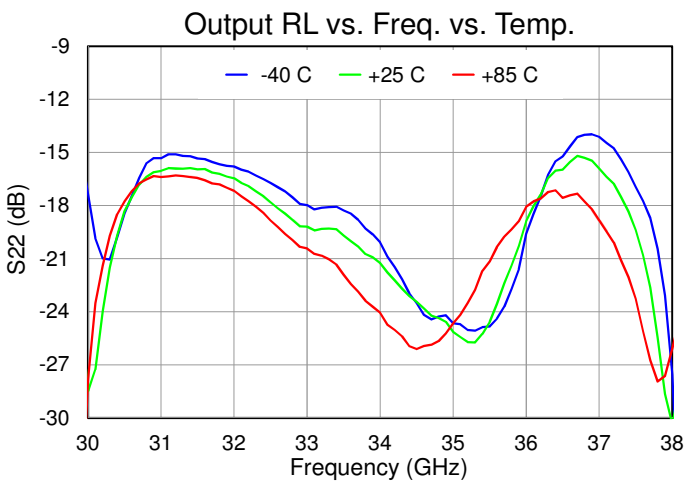
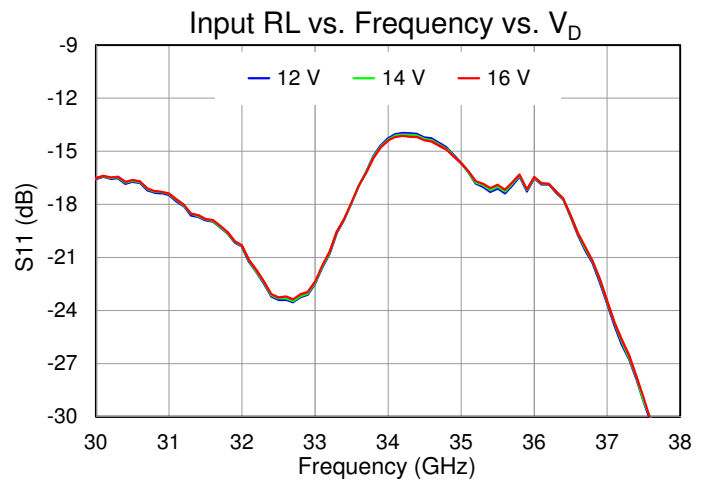
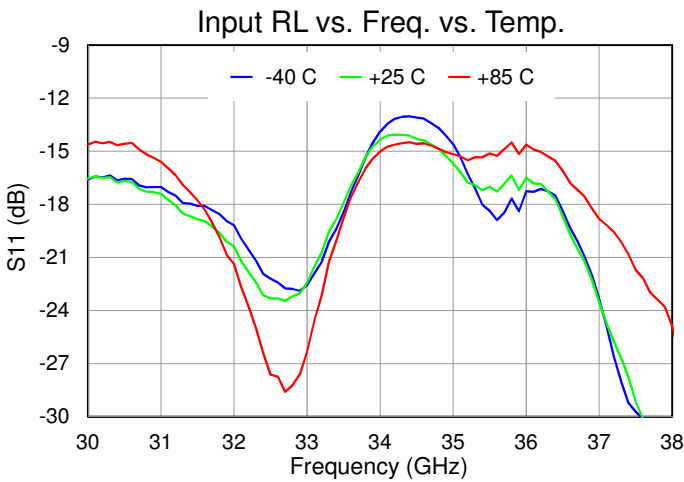
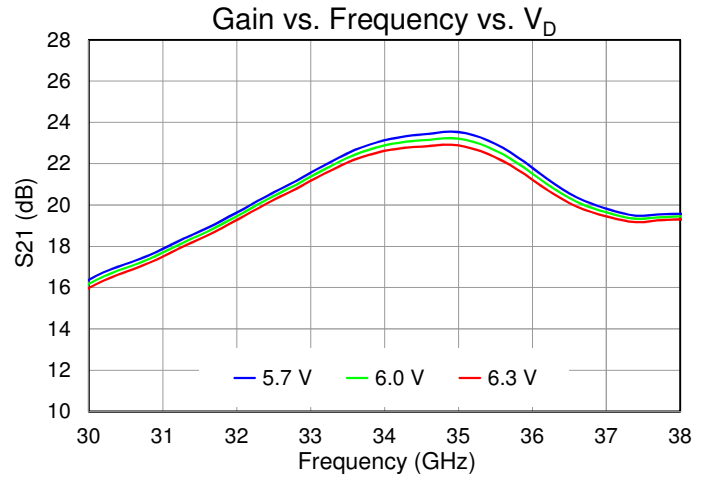
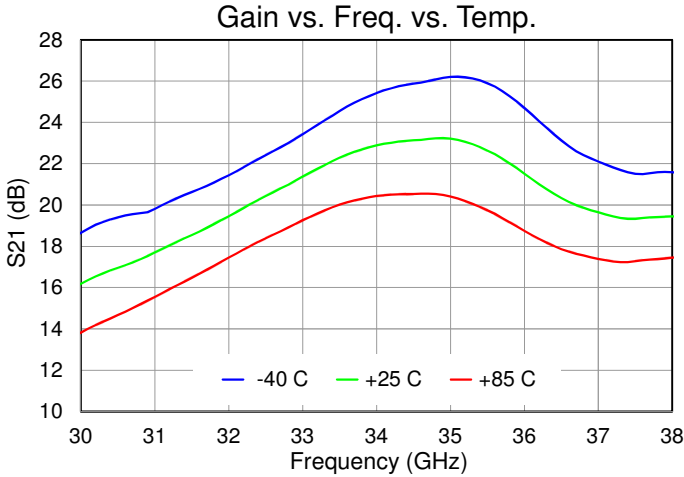

Thermal and Reliability Information

Parameter	Test Conditions	Value	Units
Thermal Resistance ( $\theta_{JC}$ ) <sup>(1)</sup>	$T_{BASE} = 85\text{ }^{\circ}\text{C}$ , $V_D = 6\text{ V}$ , $I_{DQ} = 2.1\text{ A}$ , No RF (quiescent DC operation)	5.92	$^{\circ}\text{C/W}$
Channel Temperature, $T_{CH}$ (Under RF) <sup>(2)</sup>	$P_{DISS} = 12.6\text{ W}$	160	$^{\circ}\text{C}$
Thermal Resistance ( $\theta_{JC}$ ) <sup>(1)</sup>	$T_{BASE} = 85\text{ }^{\circ}\text{C}$ , Pulsed $V_D = 6\text{ V}$ , $I_{DQ} = 2.1\text{ A}$ , Freq = 38 GHz, $I_{D\_Drive} = 3.035\text{ A}$ , $PW = 50\text{ }\mu\text{S}$ , DC = 35%,	5.97	$^{\circ}\text{C/W}$
Channel Temperature, $T_{CH}$ (Under RF) <sup>(2)</sup>	$P_{IN} = 23\text{ dBm}$ , $P_{OUT} = 34.6\text{ dBm}$ , $P_{DISS} = 15.5\text{ W}$	178	$^{\circ}\text{C}$

Notes:

1. Thermal resistance determined to the back of package ( $T_{BASE} = 85\text{ }^{\circ}\text{C}$ )

Test conditions, unless otherwise noted:  
Pulsed  $V_D = 6\text{ V}$ ,  $I_{DQ} = 2.1\text{ A}$ ,  $PW = 50\text{ }\mu\text{S}$ , DC = 35%, CW  $P_{IN} = 23\text{ dBm}$ ,  $T_{BASE} = 85\text{ }^{\circ}\text{C}$

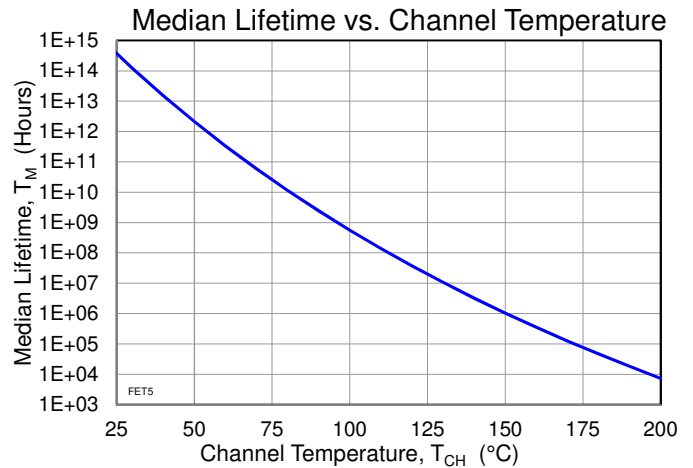
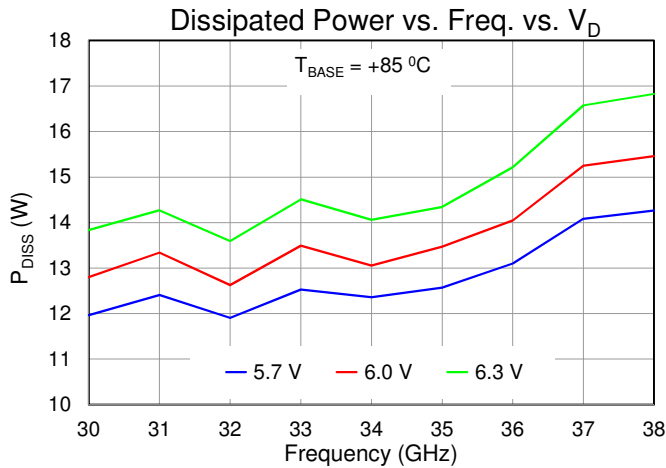

Applications Circuit (Pulsed  $V_D$ )

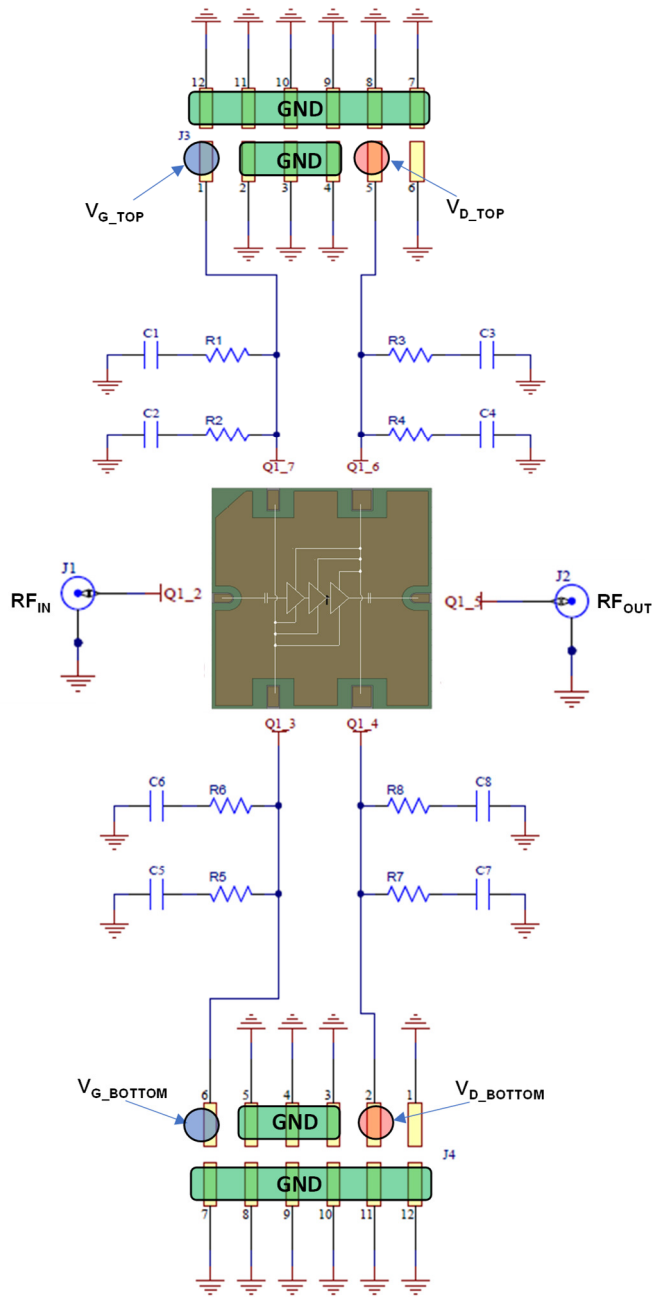

**Bias-Up Procedure**

1. Set  $I_D$  limit to 3.6 A,  $I_G$  limit to 20 mA
2. Set  $V_G$  to  $-1.5$  V
4. Set  $V_D$  +6 V
5. Adjust  $V_G$  more positive until  $I_{DQ} = 2.1$  A
6. Apply RF signal

**Bias-Down Procedure**

1. Turn off RF signal
2. Reduce  $V_G$  to  $-1.5$  V. Ensure  $I_{DQ} \sim 0$  mA
3. Set  $V_D$  to 0 V
4. Turn off  $V_D$  supply
5. Turn off  $V_G$  supply

Application Evaluation Board

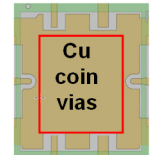
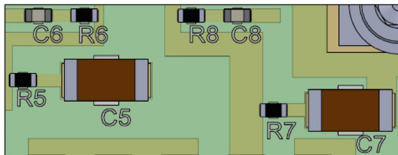
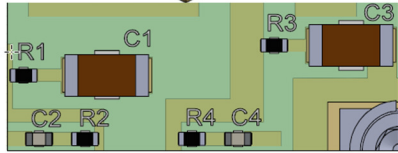
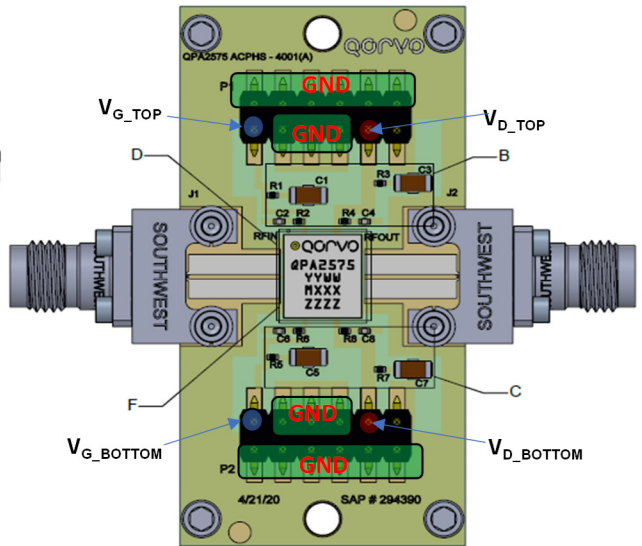
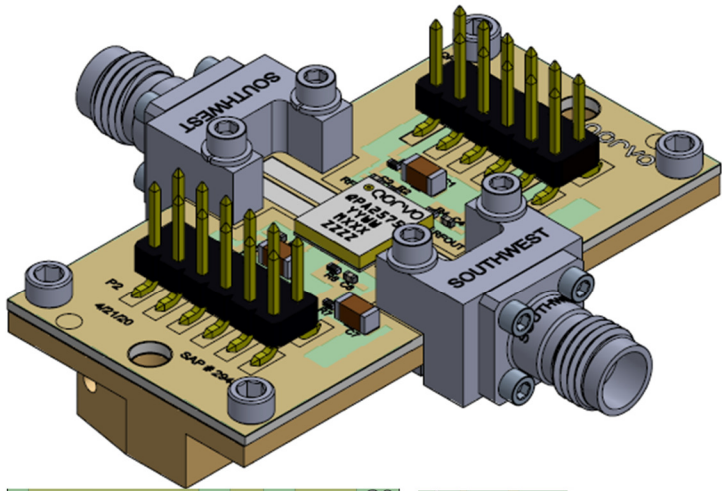

View B and C

View D and F

Material	Layer	Thickness	Dielectric Material	Type	Gerber
	Top Overlay			Legend	GTO
Surface Material	Top Solder	0.0004in	Solder Resist	Solder Mask	GTS
Copper	METAL_1_TOP	0.0028in		Signal	GTL
Prepreg	CF-004	0.0050in	Rogers 6202	Dielectric	
Prepreg	METAL_2_MID	0.0017in		Signal	G1
Core		0.0050in	370HR	Dielectric	
Copper	METAL_3_BOT	0.0210in	LAM 370HR	Dielectric	
		0.0017in		Signal	GBL
Total thickness: 0.0376in					

PCB Layers

Bill of Materials

Reference Des.	Value	Description	Manuf.	Part Number
C1, C3, C5, C7	10 uF	CAP, 10uF, ±20%, 50V, X5R, 1206	Various	
C2, C4, C6, C8	0.01 uF	CAP, 0.01uF, ±10%, 50V, X7R, 0402	Various	
R1, R2, R4 – R6, R8	5.1 Ω	RES, 5.1 Ohm, 5%, 50V, 0402	Various	
R3, R7	0 Ω	RES, 0 Ohm, JMPR, 0402	Various	
H1, H2	-	Header, connector, 2x6, 0.100", SMD		
J1, J2	-	Connector, Female, End Launch, 2.4mm	Southwest Microwave	
J3, J4	-	Connector, Header, 2x6, 0.100", SMD		
S1 – S4		Screw, cap, socket head, 2-56x1/8"		
PCB	-	Core FR4 0.027"thick, copper metal with immersion silver final plating. Total PCB thickness is 0.0376"	Rogers Corp.	Custom
Carrier	-	T-Carrier, Copper C110, 0.990 x 2.000 x 0.275"		Custom
Preform Solder	-	Preform, Solder, 0.984 x 1.994, 0.003"		
Solder	-	Paste, solder, Sn62Pb37, type 3		

Mechanical Information

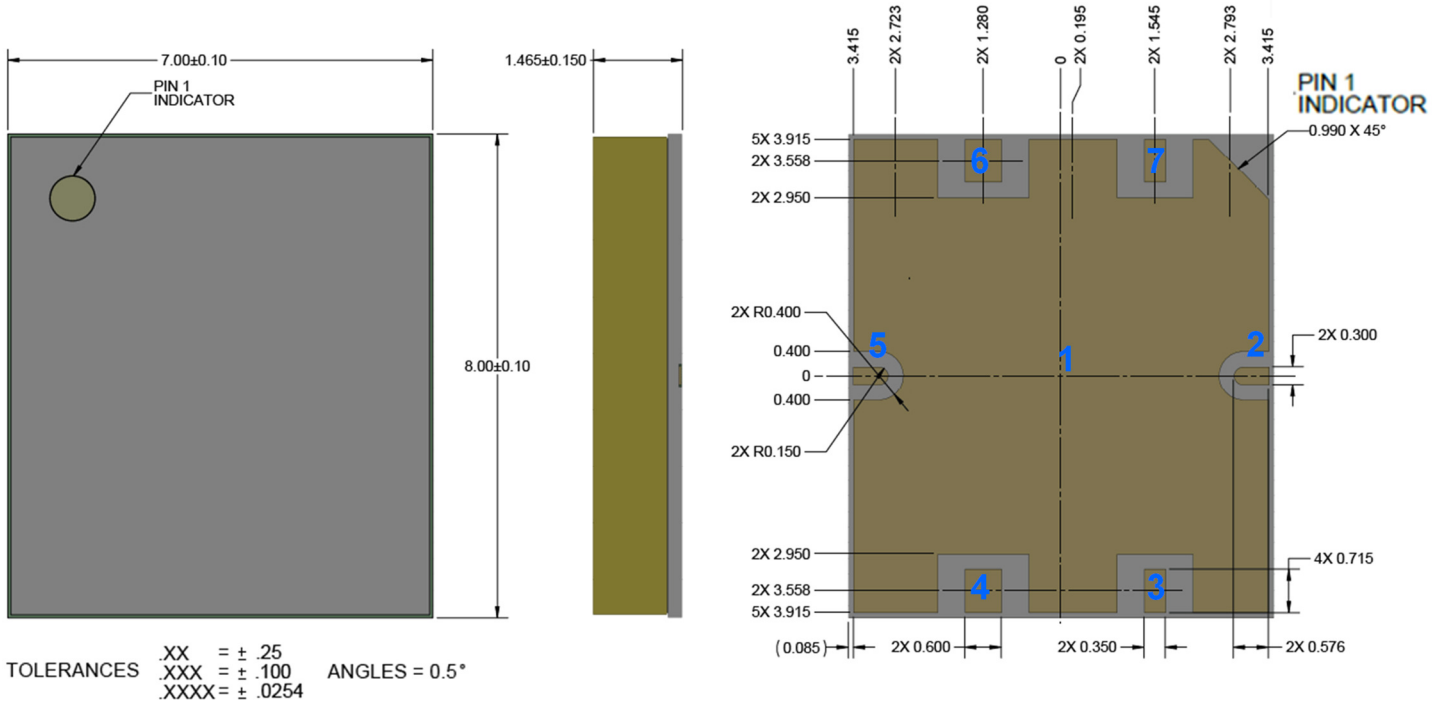

Notes: unless otherwise specified;

1. Dimensions: millimeters (mm)
2. Package is air cavity, leads are gold (Au) plated of 0.10um min., base is laminate; Part is epoxy sealed
3. Marking: YY is calendar year; WW is assembly week; MXXX is batch ID

Pin Description

Pin Number	Symbol	Description
1	Center Pad	Ground connection
2	RF <sub>IN</sub>	RF input. 50 Ohms. DC blocked.
3	V <sub>G</sub>	Gate voltage, bottom. Bypass network required; refer to page 11
4	V <sub>D</sub>	Drain voltage, bottom. Bypass network required; refer to page 11
5	RF <sub>OUT</sub>	RF output. 50 Ohms. DC blocked.
6	V <sub>D</sub>	Drain voltage, top. Bypass network required; refer to page 11
7	V <sub>G</sub>	Gate voltage, top. Bypass network required; refer to page 11

Tape and reel Information

Standard T/R size = 250 pieces on a 7" reel  
 Dimensions: millimeters (mm)  
 Tolerances unless otherwise noted: .X = ± .2; .XX = ± .10

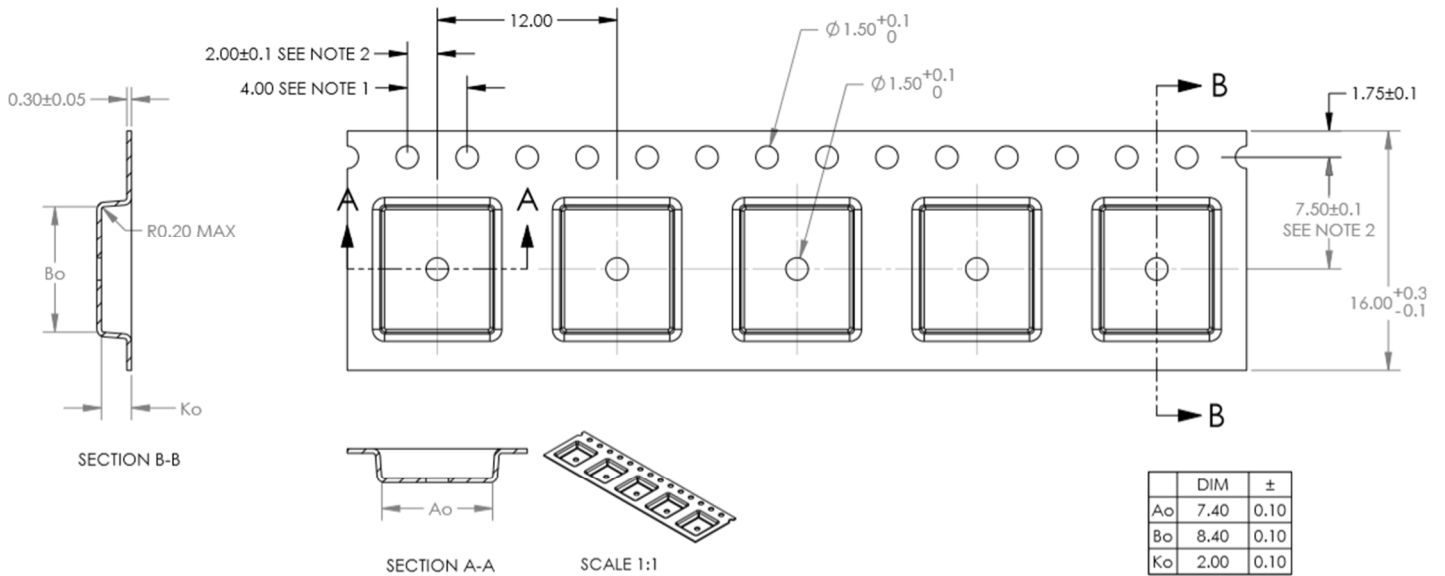

ALL DIMS IN MILLIMETERS  
 PER ASME Y14.5M  
 TOLERANCES UNLESS - SPECIFIED  
 1 PL ± 0.2 2 PL ± 0.10

- NOTES:
1. 10 SPROCKET HOLE PITCH CUMULATIVE TOLERANCE ±0.2
  2. POCKET POSITION RELATIVE TO SPROCKET HOLE MEASURED AS TRUE POSITION OF POCKET, NOT POCKET HOLE.
  3. Ao AND Bo ARE MEASURED ON A PLANE AT A DISTANCE "R" ABOVE THE BOTTOM OF THE POCKET.

**Solderability**

Compatible with lead-free soldering processes with 260°C peak reflow temperature.

This package is air-cavity and non-hermetic, and therefore cannot be subjected to aqueous washing. The use of no-clean solder to avoid washing after soldering is highly recommended.

Contact plating: Ni-Au

Solder rework not recommended

**Recommended Soldering Temperature Profile**

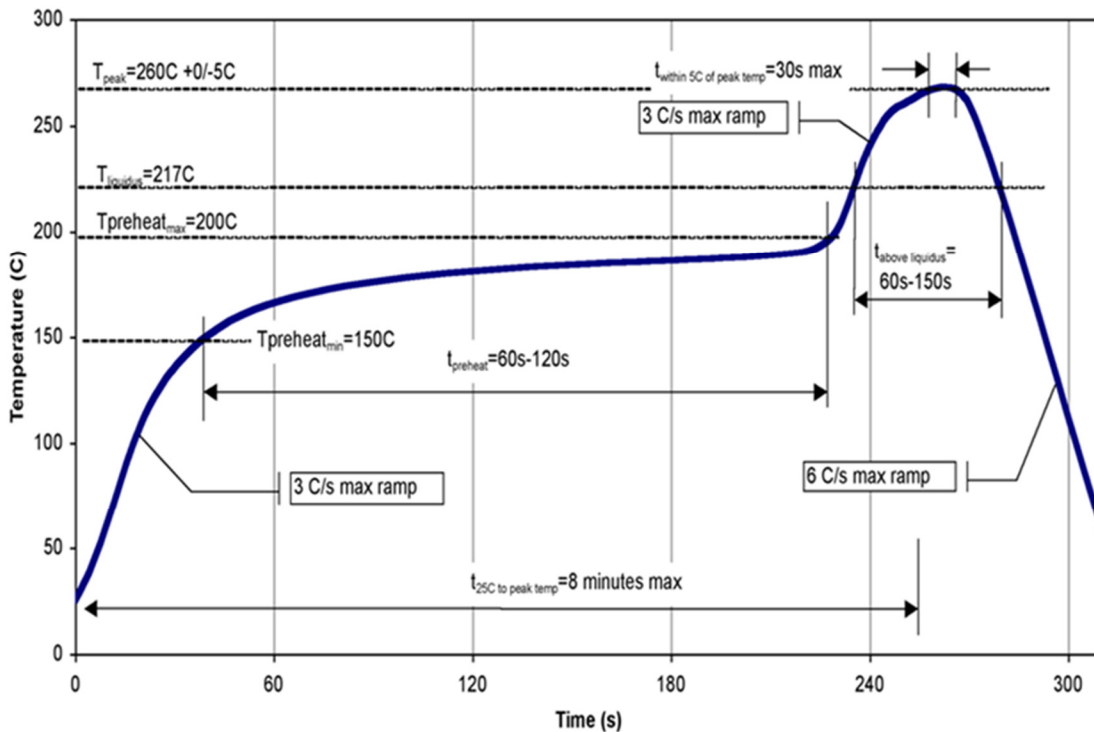

## Handling Precautions

Parameter	Rating	Standard
ESD – Human Body Model (HBM)	1B	ANSI/ESD/JEDEC JS-001
ESD – Charged Device Model (CDM)	C3	ANSI/ESD/JEDEC JS-002
MSL – Moisture Sensitivity Level	3	IPC/JEDEC J-STD-020



Caution!  
ESD-Sensitive Device

## RoHS Compliance

This product is compliant with the 2011/65/EU RoHS directive (Restrictions on the Use of Certain Hazardous Substances in Electrical and Electronic Equipment), as amended by Directive 2015/863/EU.

This product also has the following attributes:

- Lead Free
- Antimony Free
- TBBP-A (C<sub>15</sub>H<sub>12</sub>Br<sub>4</sub>O<sub>2</sub>) Free
- SVHC Free
- PFOS Free

## Contact Information

For the latest specifications, additional product information, world

Web: [www.qorvo.com](http://www.qorvo.com)

Tel: 1-844-890-8163

Email: [customer.support@qorvo.com](mailto:customer.support@qorvo.com)

## Important Notice

The information contained herein is believed to be reliable; however, Qorvo makes no warranties regarding the information contained herein and assumes no responsibility or liability whatsoever for the use of the information contained herein. All information contained herein is subject to change without notice. Customers should obtain and verify the latest relevant information before placing orders for Qorvo products. The information contained herein or any use of such information does not grant, explicitly or implicitly, to any party any patent rights, licenses, or any other intellectual property rights, whether with regard to such information itself or anything described by such information. **THIS INFORMATION DOES NOT CONSTITUTE A WARRANTY WITH RESPECT TO THE PRODUCTS DESCRIBED HEREIN, AND QORVO HEREBY DISCLAIMS ANY AND ALL WARRANTIES WITH RESPECT TO SUCH PRODUCTS WHETHER EXPRESS OR IMPLIED BY LAW, COURSE OF DEALING, COURSE OF PERFORMANCE, USAGE OF TRADE OR OTHERWISE, INCLUDING THE IMPLIED WARRANTIES OF MERCHANTABILITY AND FITNESS FOR A PARTICULAR PURPOSE.**

Without limiting the generality of the foregoing, Qorvo products are not warranted or authorized for use as critical components in medical, life-saving, or life-sustaining applications, or other applications where a failure would reasonably be expected to cause severe personal injury or death.

© 2023 Qorvo US, Inc. All rights reserved. This document is subject to copyright laws in various jurisdictions worldwide and may not be reproduced or distributed, in whole or in part, without the express written consent of Qorvo US, Inc.

## Looking for pricing, stock, or lifecycle information?

Click below to explore more details on WIN SOURCE:

 [View QPA2575TR7 on WIN SOURCE](#)

 [Qorvo US Inc. Information](#)

## Optimize Your Supply Chain with WIN SOURCE Solutions

-  Global Sourcing Solution
-  Obsolete Management
-  Cost Control Management
-  Shortage Management
-  Alternative Solution
-  Excess Inventory Management