



REFLECTIONLESS

# High Pass Filter

## XHF2-153+

50Ω 15.3 to 30 GHz

### THE BIG DEAL

- Match to 50Ω in the stop band, eliminates undesired reflections
- Cascadable
- Excellent Power handling
- Temperature stable, up to +105°C
- Small size, 2 x 2 mm
- Protected by US Patent No. 8,392,495



Generic photo used for illustration purposes only

CASE STYLE: MC1630-1

### +RoHS Compliant

The +Suffix identifies RoHS Compliance. See our website for methodologies and qualifications

### APPLICATIONS

- Wi-Fi
- WiMax
- Microwave Radio
- Military & Space

### PRODUCT OVERVIEW

Mini-Circuits' XHF2-153+ reflectionless filter employs a novel filter topology which absorbs and terminates stop band signals internally rather than reflecting them back to the source. This new capability enables unique applications for filter circuits beyond those suited to traditional approaches. Traditional filters are reflective in the stop band, sending signals back to the source at 100% of the power level. These reflections interact with neighboring components and often result in inter-modulation and other interferences. Reflectionless filters eliminate stop band reflections, allowing them to be paired with sensitive devices and used in applications that otherwise require circuits such as isolation amplifiers or attenuators.

### KEY FEATURES

Feature	Advantages
Easy integration with sensitive reflective components, e.g. mixers, multipliers	Reflectionless filters absorb unwanted signals falling in filter stopband, preventing reflections back to the source. This reduces generation of additional unwanted signals without the need for extra components like attenuators, improving system dynamic range and saving board space.
Enables stable integration of wideband amplifiers	Because reflectionless filters maintain good impedance in the stopband; they can be integrated with high gain, wideband amplifiers without the risk of creating instabilities in these out of band regions.
Cascadable	Reflectionless filters can be cascaded in multiple sections to provide sharper and higher attenuation, while also preventing any standing waves that could affect passband signals. Low & highpass filters can be cascaded to realize bandpass filters.
Excellent power handling in a tiny surface mount device	High power handling extends the usability of these filters to the transmit path for inter-stage filtering.
Small size, 2x2mm QFN-Style	Allows replacement of filter/attenuator pairs with a single reflectionless filter, saving board space.
Excellent repeatability of RF performance	Through semiconductor IPD process, X-series filters are inherently repeatable for large volume production.
Operating temperature up to +105°C	Suitable for operation close to high power components.

IPD - Integrated Passive Device, is a GaAs semiconductor process

REV. C  
ECO-021591  
XHF2-153+  
MCL NY  
240423





REFLECTIONLESS

# High Pass Filter

## XHF2-153+

Mini-Circuits

50Ω 15.3 to 30 GHz

### ELECTRICAL SPECIFICATIONS<sup>1</sup> AT +25°C

Parameter	F#	Frequency (MHz)	Min.	Typ.	Max.	Unit
Stop Band	Rejection	DC - F'	DC - 2400	—	6.8	—
		F' - F1	2400 - 12000	12.0	13.7	—
	Frequency Cut-off	F2	14200	—	2.9	—
	VSWR	DC - F'	DC - 2400	—	2.7	—
		F' - F1	2400 - 12000	—	2.2	—
Pass Band	Insertion Loss	F3 - F4	15300 - 26000	—	1.8	—
		F4 - F5	26000 - 30000	—	0.7	—
	VSWR	F3 - F4	15300 - 26000	—	2.1	—
		F4 - F5	26000 - 30000	—	1.6	—

1. Measured on Mini-Circuits Characterization Test Board TB-883-153+

### ABSOLUTE MAXIMUM RATINGS<sup>2</sup>

Parameter	Ratings
Operating Temperature	-55°C to +105°C
Storage Temperature	-65°C to +150°C
RF Power Input, Passband (F3-F5) <sup>3</sup>	1.26 W at +25°C
RF Power Input, Stopband (DC-F3) <sup>4</sup>	0.16 W at +25°C

- 2. Permanent damage may occur if any of these limits are exceeded.
- 3. Passband rating derates linearly to 0.63 W at 105°C ambient
- 4. Stopband rating derates linearly to 0.08 W at 105°C ambient

### SPECIFICATION DEFINITION

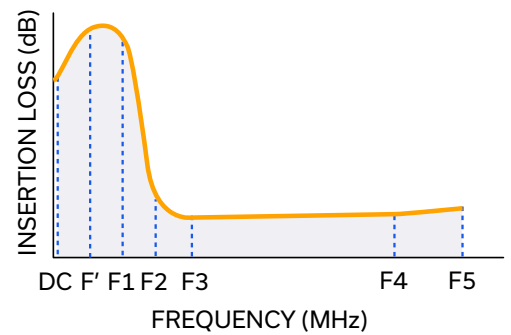



REFLECTIONLESS

# High Pass Filter

## XHF2-153+

Mini-Circuits

50Ω 15.3 to 30 GHz

### SIMPLIFIED SCHEMATIC AND PAD DESCRIPTION

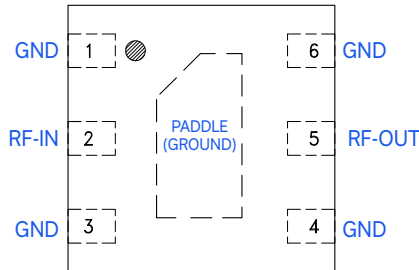
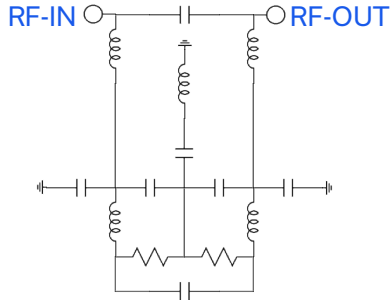

Function	Pad Number	Description
RF-IN	2	RF Input Pad
RF-OUT	5	RF Output Pad
GND	1,3,4,6, Paddle	Connected to ground

### PRODUCT MARKING

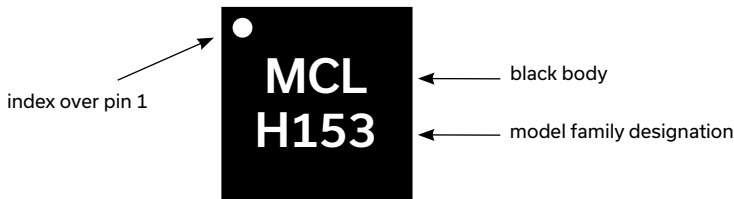

Marking may contain other features or characters for internal lot control



REFLECTIONLESS

# High Pass Filter

## XHF2-153+

Mini-Circuits

50Ω 15.3 to 30 GHz

### TYPICAL PERFORMANCE DATA AT +25°C

Frequency (MHz)	Insertion Loss (dB)	VSWR (:1)
100	6.83	2.59
500	7.31	2.61
1000	8.72	2.60
1500	10.78	2.51
2000	13.33	2.34
2400	15.63	2.15
3000	19.15	1.85
4000	20.71	1.44
8000	27.73	1.41
10000	17.45	1.45
12000	14.37	1.77
14500	2.72	1.38
16000	1.47	1.32
18000	0.99	1.22
20000	1.29	1.92
26000	0.81	1.24
30000	0.96	1.27

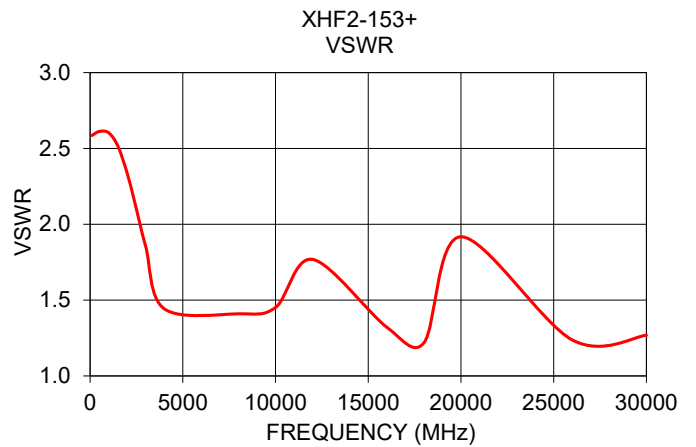
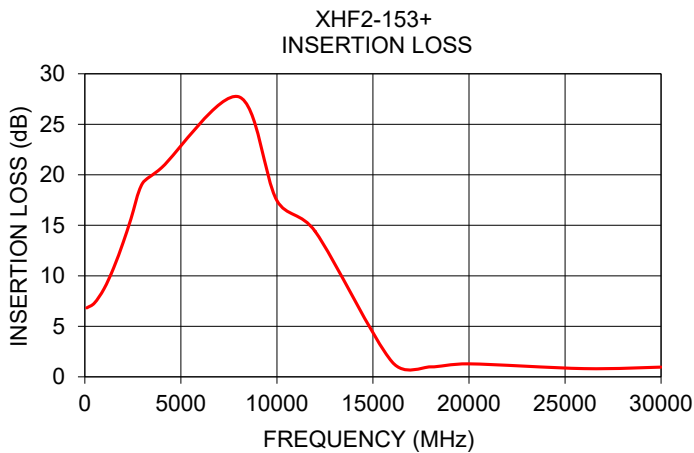



REFLECTIONLESS

# High Pass Filter

## XHF2-153+

50Ω 15.3 to 30 GHz

ADDITIONAL DETAILED TECHNICAL INFORMATION IS AVAILABLE ON OUR DASH BOARD. TO ACCESS [CLICK HERE](#)

Performance Data & Graphs	Data Graphs S-Parameter (S2P Files) Data Set (.zip file)
Case Style	MC1630-1 Plastic package, exposed paddle lead finish: matte-tin
Tape & Reel Standard quantities available on reel	F66 7" reels with 20, 50, 100, 200, 500 ,1000, 2000 or 3000 devices
Suggested Layout for PCB Design	PL-499
Evaluation Board	TB-883-1352+ (without connectors) TB-883-1352C+ (with connectors) B20-118-F1+ connector sold separately
Environmental Ratings	ENV82

### ESD RATING

Human body model (HBM): Class 1A (250 to<500 V) in accordance with ANSI/ESD 5.1-2001

- NOTES**
- A. Performance and quality attributes and conditions not expressly stated in this specification document are intended to be excluded and do not form a part of this specification document.
  - B. Electrical specifications and performance data contained in this specification document are based on Mini-Circuit's applicable established test performance criteria and measurement instructions.
  - C. The parts covered by this specification document are subject to Mini-Circuits standard limited warranty and terms and conditions (collectively, "Standard Terms"); Purchasers of this part are entitled to the rights and benefits contained therein. For a full statement of the standard terms and the exclusive rights and remedies thereunder, please visit Mini-Circuits' website at [www.minicircuits.com/MCLStore/terms.jsp](http://www.minicircuits.com/MCLStore/terms.jsp)



## Looking for pricing, stock, or lifecycle information?

Click below to explore more details on WIN SOURCE:

 [View XHF2-153+ on WIN SOURCE](#)

 [Mini-Circuits Information](#)

## Optimize Your Supply Chain with WIN SOURCE Solutions

-  Global Sourcing Solution
-  Obsolete Management
-  Cost Control Management
-  Shortage Management
-  Alternative Solution
-  Excess Inventory Management