

GaAs pHEMT MMIC 1 WATT POWER AMPLIFIER, DC - 22 GHz

Typical Applications

The HMC797APM5E is ideal for:

- Test Instrumentation
- Military & Space
- Fiber Optics

Features

- High P1dB Output Power: +29 dBm
- High Psat Output Power: +31 dBm
- High Gain: 15 dB
- High Output IP3: +41 dBm
- Supply Voltage: +10 V @ 400 mA
- 50 Ohm Matched Input/Output
- 32 Lead 5x5 mm SMT Package: 25 mm²

Functional Diagram

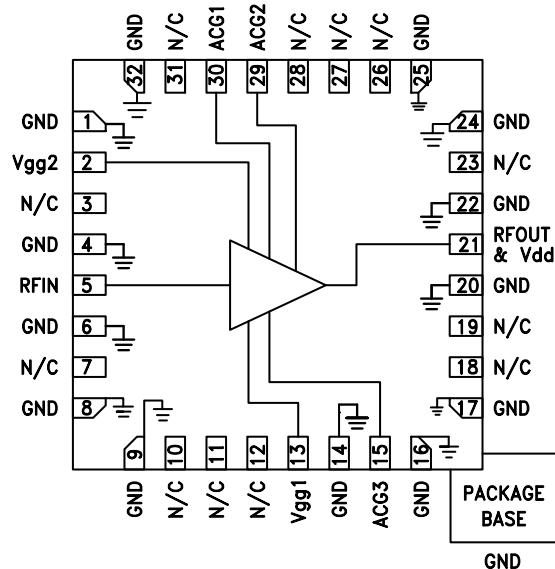

General Description

The HMC797APM5E is a GaAs MMIC pHEMT Distributed Power Amplifier which operates between DC and 22 GHz. The amplifier provides 15 dB of gain, +29 dBm of output power at 1 dB gain compression, +31 dBm of saturated output power, and 25% PAE while requiring 400 mA from a +10 V supply. With up to +41 dBm of output IP3, the HMC797APM5E is ideal for high linearity applications in military and space as well as test equipment where high order modulations are used. This versatile PA exhibits a positive gain slope from 2 to 20 GHz making it ideal for EW, ECM, Radar and test equipment applications. The HMC797APM5E amplifier I/Os are internally matched to 50 Ohms facilitating integration into multi-chip-modules (MCMs), is packaged in a leadless QFN 5x5 mm surface mount package, and requires no external matching components.

Electrical Specifications, $T_A = +25^\circ\text{C}$, $V_{dd} = +10\text{V}$, $V_{gg2} = +3.5\text{V}$, $I_{dd} = 400\text{mA}^*$

| Parameter | Min. | Typ. | Max. | Min. | Typ. | Max. | Min. | Typ. | Max. | Units |
|--|---------|-----------|------|---------|-----------|------|---------|-----------|------|-------|
| Frequency Range | DC - 12 | | | 12 - 18 | | | 18 - 22 | | | GHz |
| Gain | 12.5 | 14.5 | | 13 | 15 | | 13 | 15.5 | | dB |
| Gain Flatness | | ± 0.7 | | | ± 0.5 | | | ± 0.5 | | dB |
| Gain Variation Over Temperature | | 0.014 | | | 0.018 | | | 0.02 | | dB/°C |
| Input Return Loss | | 15 | | | 15 | | | 15 | | dB |
| Output Return Loss | | 13 | | | 15 | | | 13 | | dB |
| Output Power for 1 dB Compression (P1dB) | 27 | 29 | | 27 | 29 | | 26 | 29 | | dBm |
| Saturated Output Power (Psat) | | 31 | | | 31 | | | 31 | | dBm |
| Output Third Order Intercept (IP3) *Measurement taken at Pout/Tone = + 18 dBm | | 42 | | | 41 | | | 41 | | dBm |
| Noise Figure | | 3.0 | | | 3.5 | | | 4 | | dB |
| Supply Current (Idd) | | 400 | | | 400 | | | 400 | | mA |
| Supply Voltage (Vdd) | 8 | 10 | 11 | 8 | 10 | 11 | 8 | 10 | 11 | V |

* Adjust Vgg1 between -2 to 0 V to achieve Idd = 400 mA typical, Vgg1 = -0.55V Typical to achieve Idd = 400 mA.

**GaAs pHEMT MMIC
1 WATT POWER AMPLIFIER, DC - 22 GHz**

Broadband Gain and Return Loss

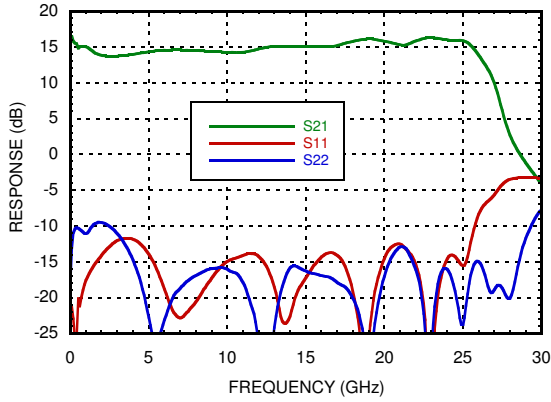

Low Frequency Gain and Return Loss

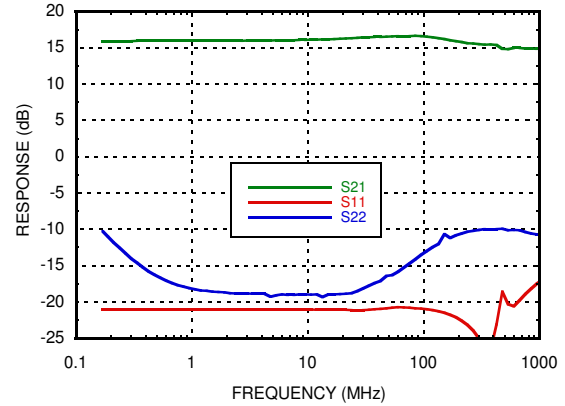

Gain vs. Temperature

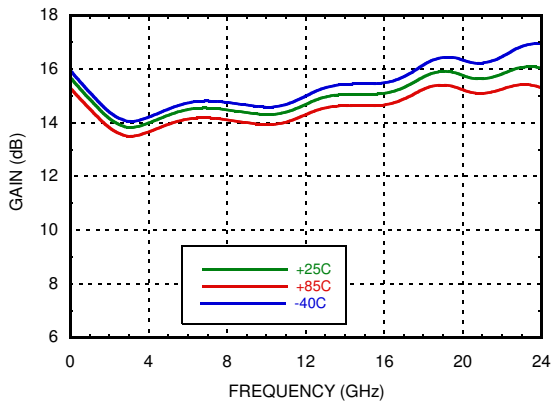

Gain vs. Vdd

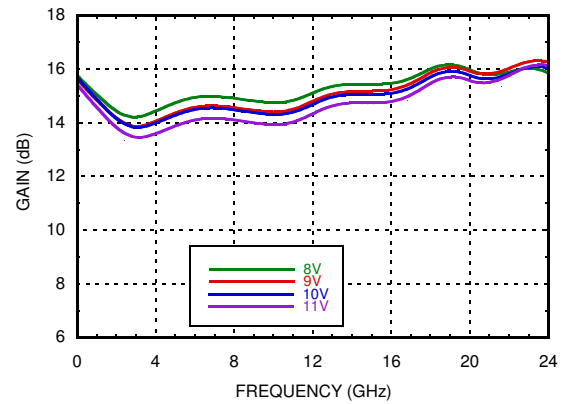

Gain vs. Idd

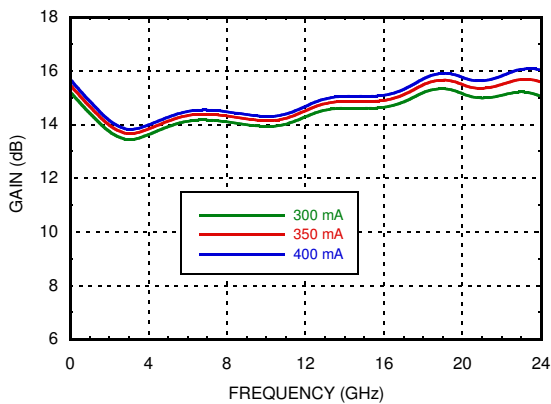

Input Return Loss vs. Temperature

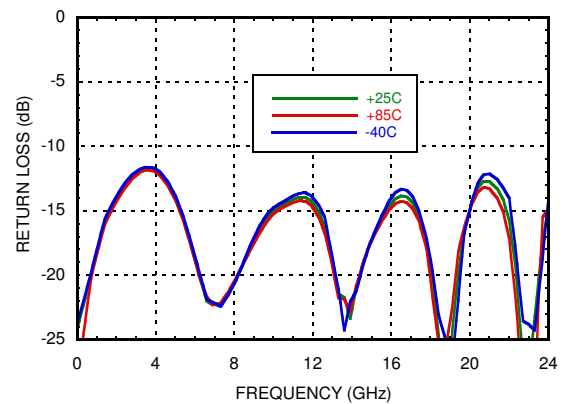

**GaAs pHEMT MMIC
1 WATT POWER AMPLIFIER, DC - 22 GHz**

Input Return Loss vs. Vdd

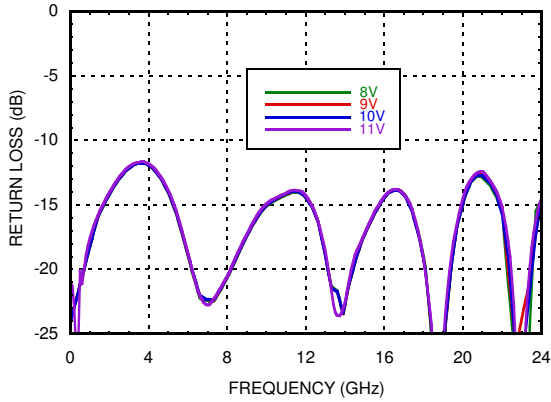

Input Return Loss vs. Idd

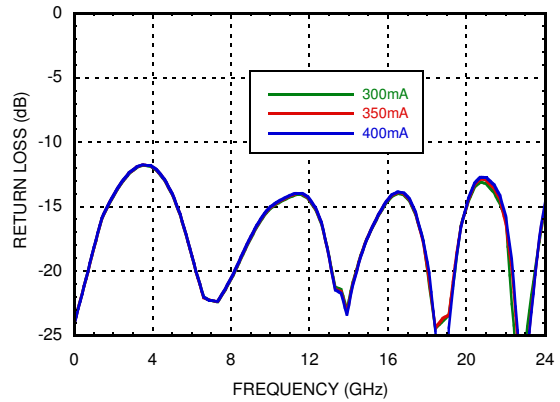

Output Return Loss vs. Temperature

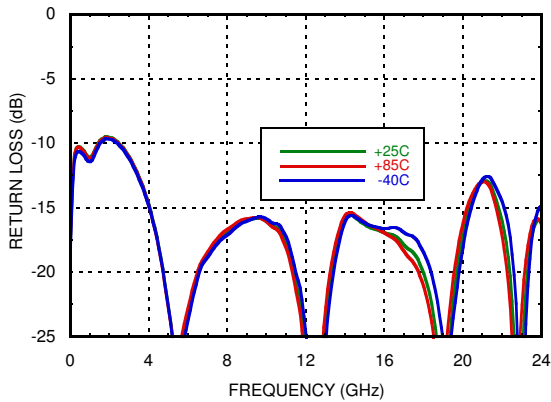

Output Return Loss vs. Vdd

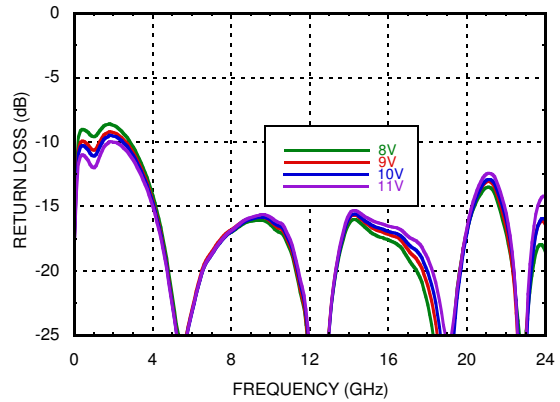

Output Return Loss vs. Idd

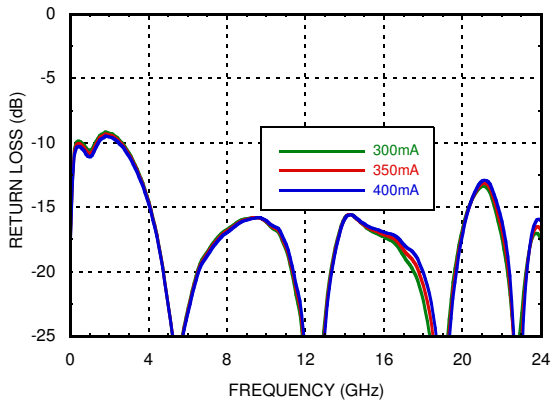

Reverse Isolation vs. Temperature

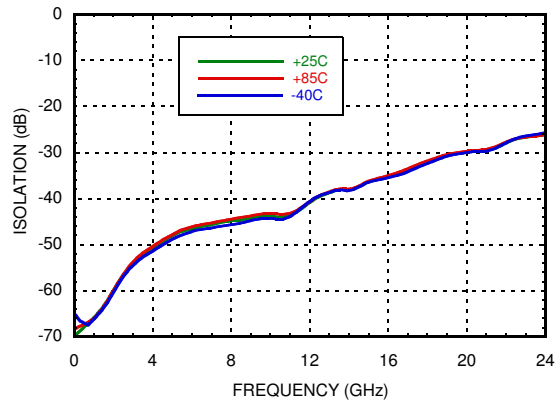

**GaAs pHEMT MMIC
1 WATT POWER AMPLIFIER, DC - 22 GHz**

Noise Figure vs. Temperature

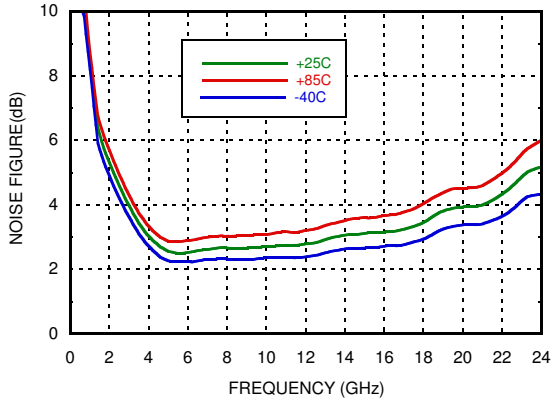

Noise Figure vs. Idd

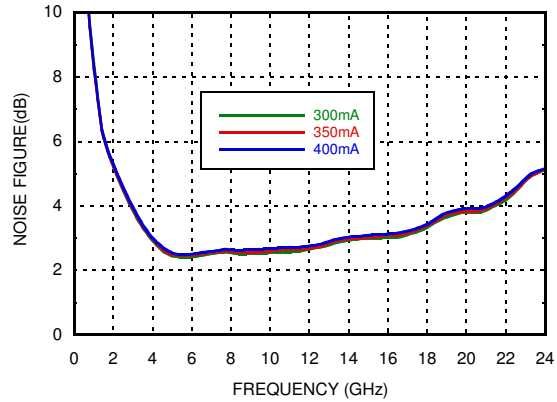

Low Frequency P1dB vs. Temperature

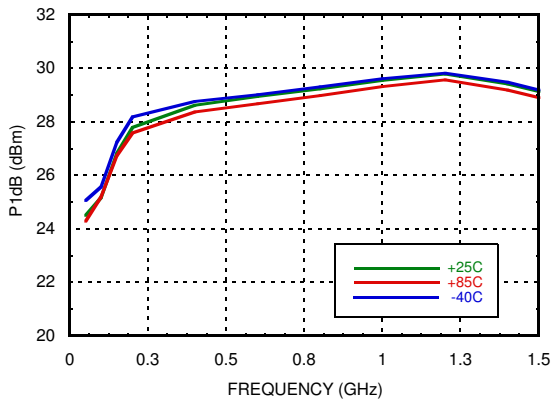

P1dB vs. Temperature

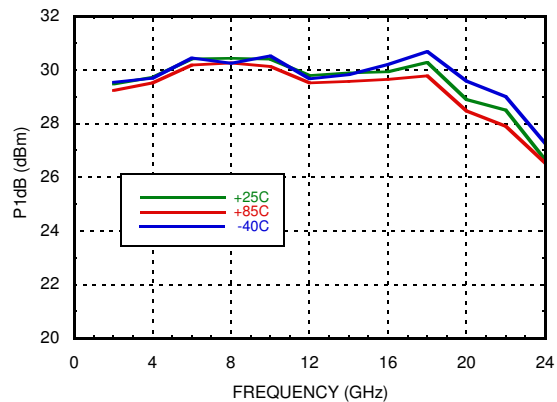

P1dB vs. Vdd

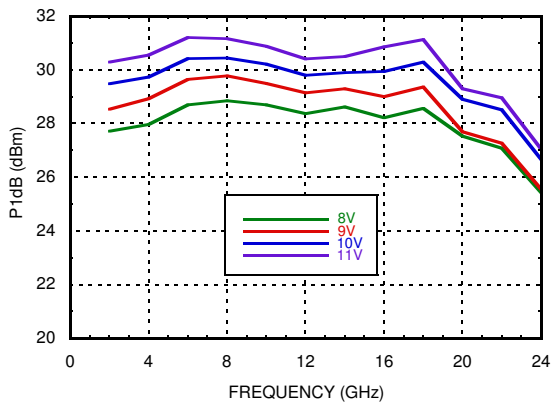

P1dB vs. Idd

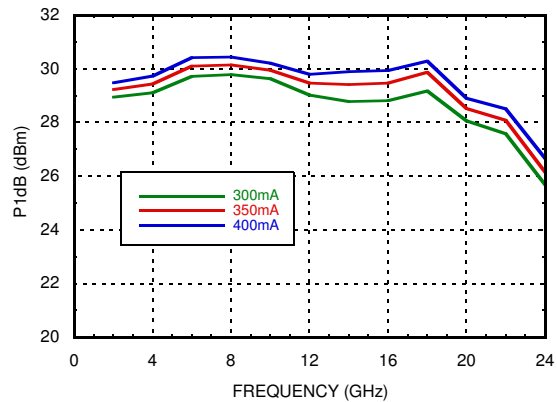

**GaAs pHEMT MMIC
1 WATT POWER AMPLIFIER, DC - 22 GHz**

Low Frequency Psat vs. Temperature

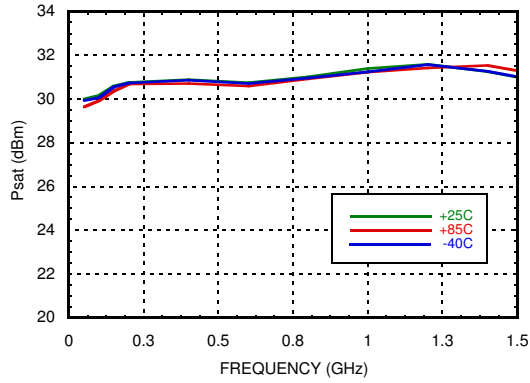

Psat vs. Temperature

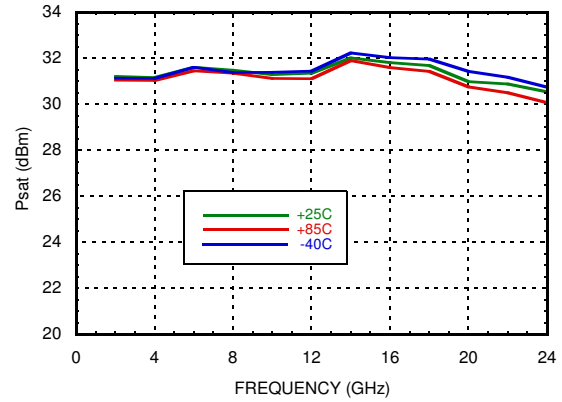

Psat vs. Vdd

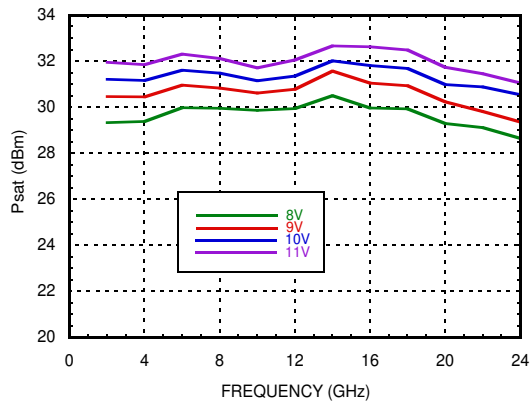

Psat vs. Idd

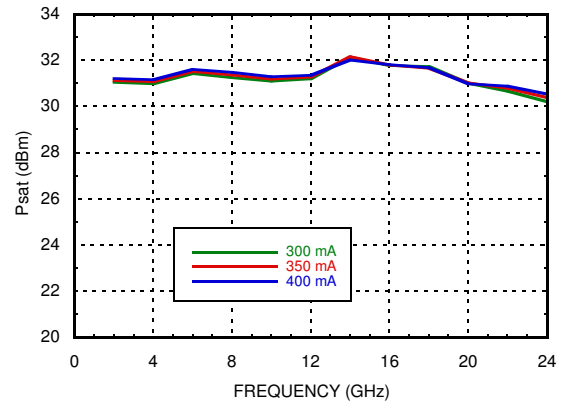

Power Compression @ 2 GHz

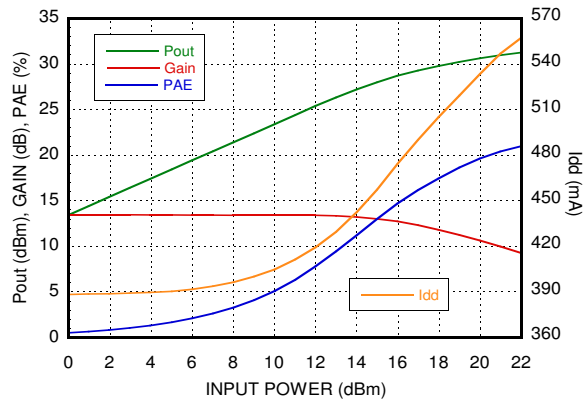

Power Compression @ 6 GHz

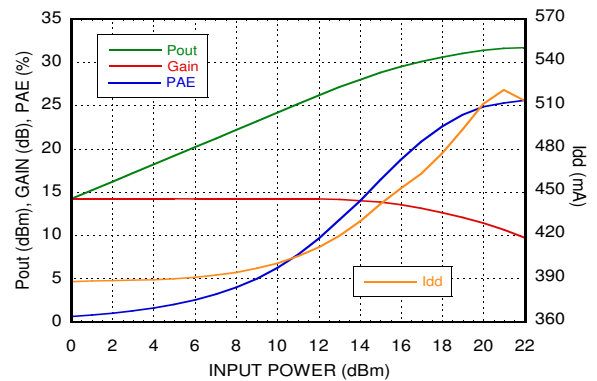

**GaAs pHEMT MMIC
1 WATT POWER AMPLIFIER, DC - 22 GHz**

Power Compression @ 10 GHz

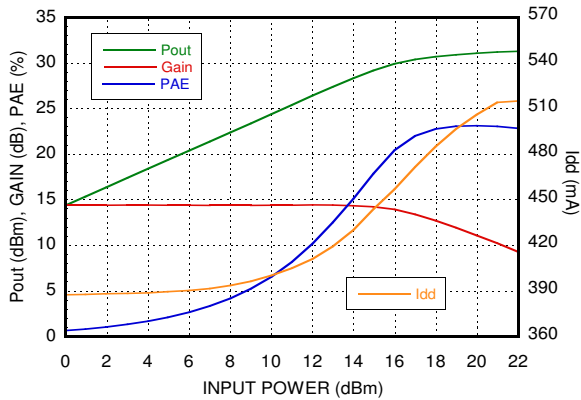

Power Compression @ 14 GHz

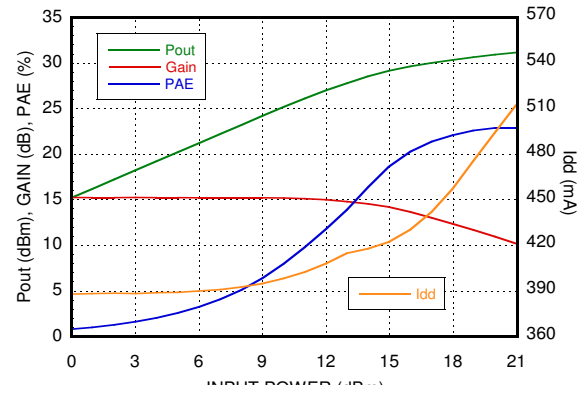

Power Compression @ 18 GHz

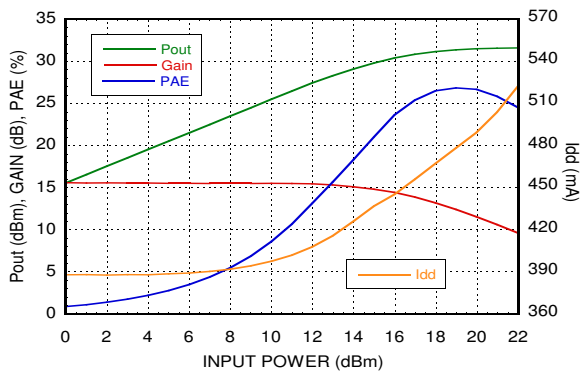

Power Compression @ 22 GHz

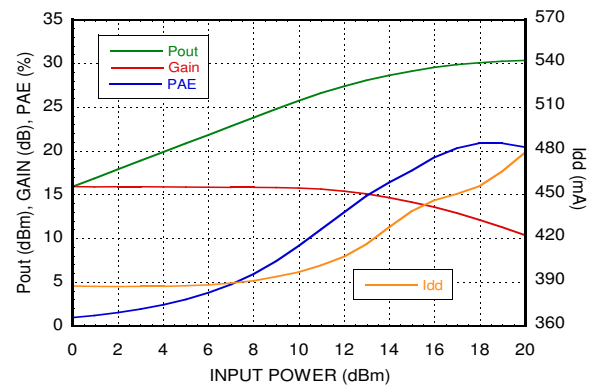

PAE @ Psat vs. Frequency

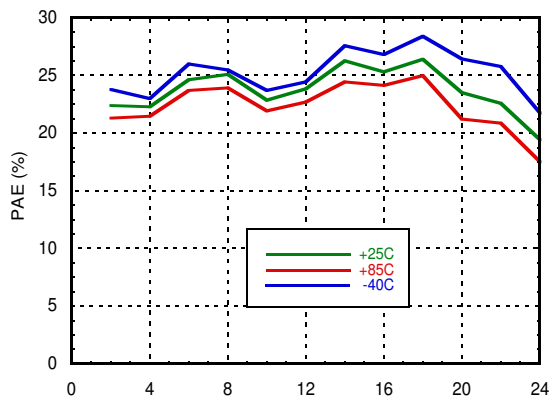

Power Dissipation @ 85 C

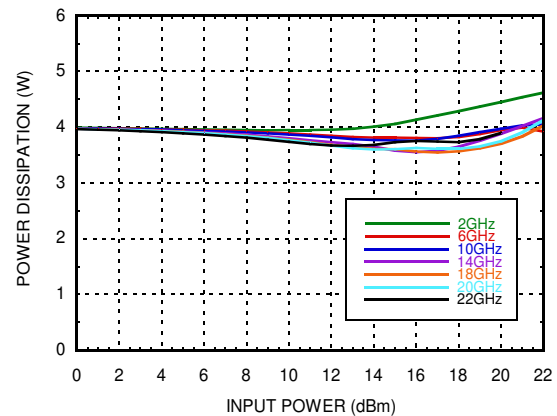

**GaAs pHEMT MMIC
1 WATT POWER AMPLIFIER, DC - 22 GHz**

Gain & Power vs. Vdd @ 2 GHz

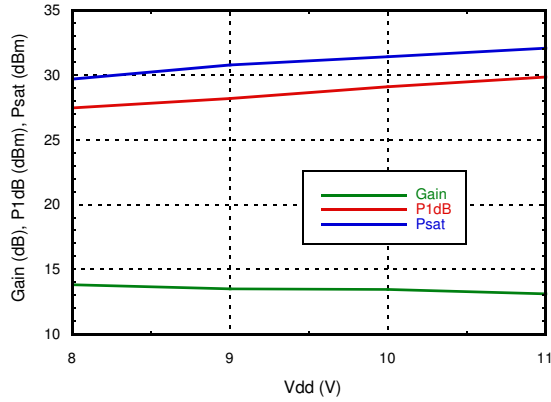

Gain & Power vs. Vdd @ 10 GHz

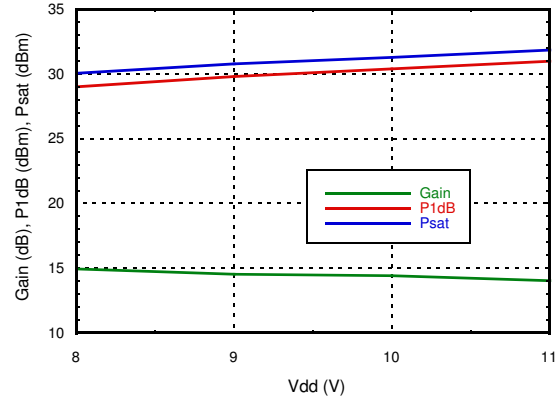

Gain & Power vs. Vdd @ 22 GHz

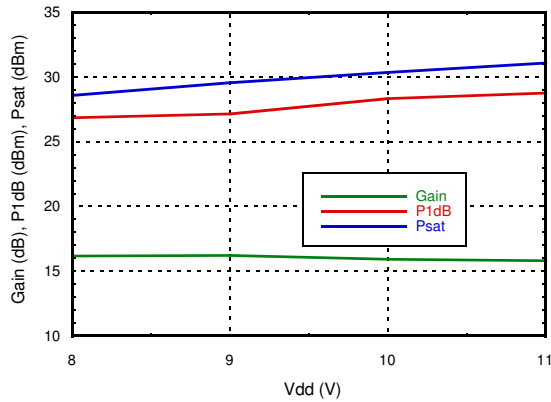

Gain & Power vs. Idd @ 2 GHz

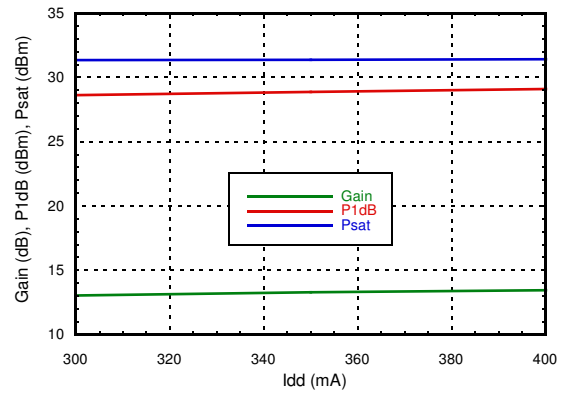

Gain & Power vs. Idd @ 10 GHz

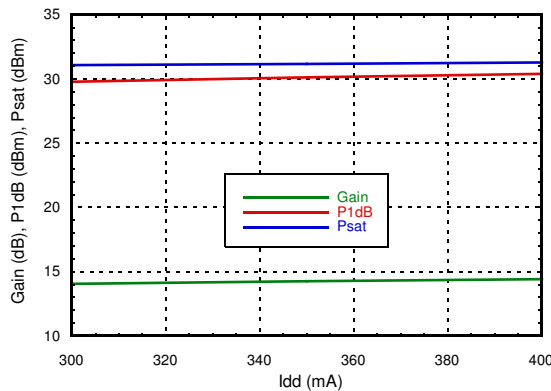

Gain & Power vs. Idd @ 22 GHz

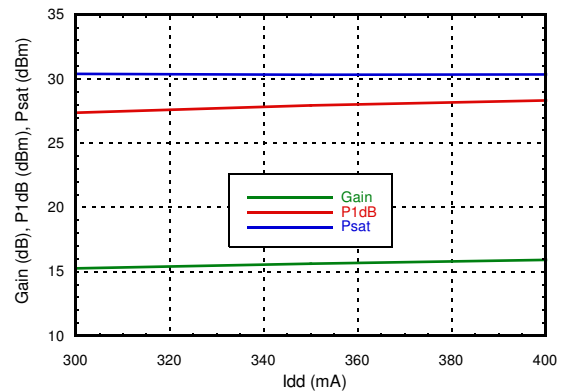

**GaAs pHEMT MMIC
1 WATT POWER AMPLIFIER, DC - 22 GHz**

**OIP3 vs. Temperature
@ Pout / Tone = +18 dBm**

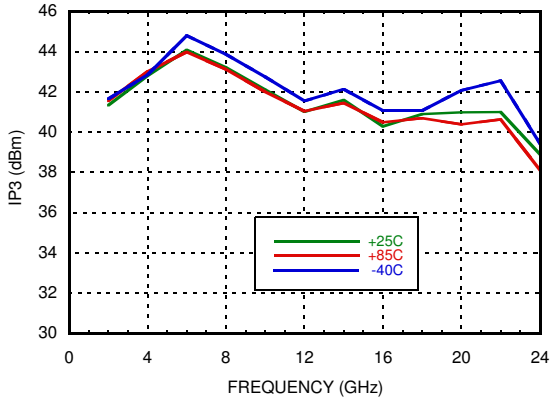

**Low Frequency OIP3 vs. Temperature
@ Pout / Tone = +18 dBm**

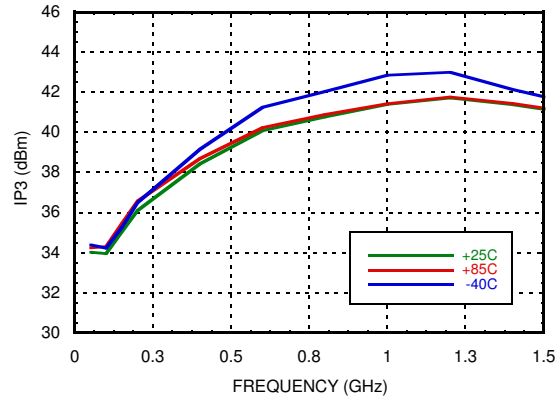

**OIP3 vs. Vdd
@ Pout / Tone = +18 dBm**

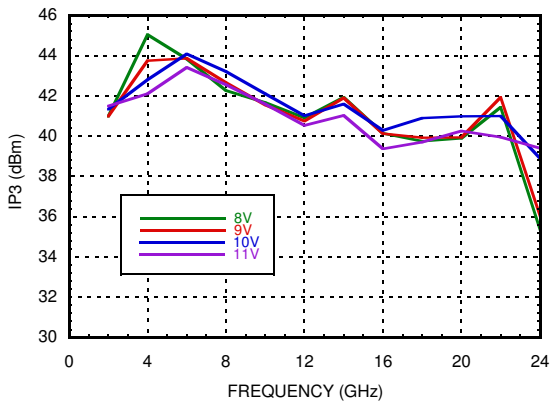

**OIP3 vs. Idd
@ Pout / Tone = +18 dBm**

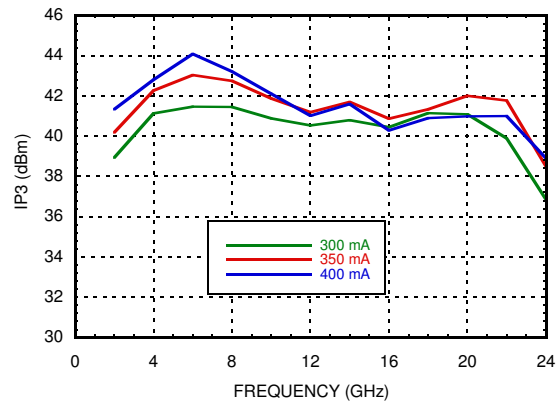

Output IM3 @ Vdd = +8 V

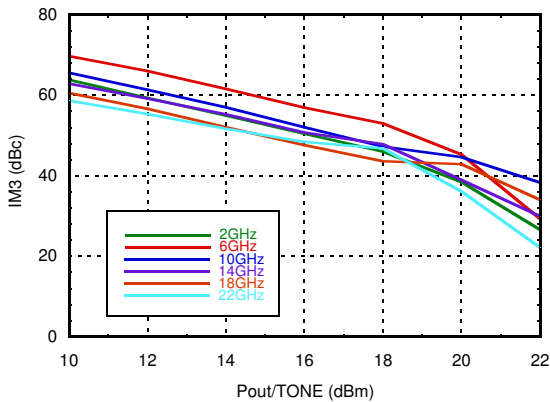

Output IM3 @ Vdd = +9 V

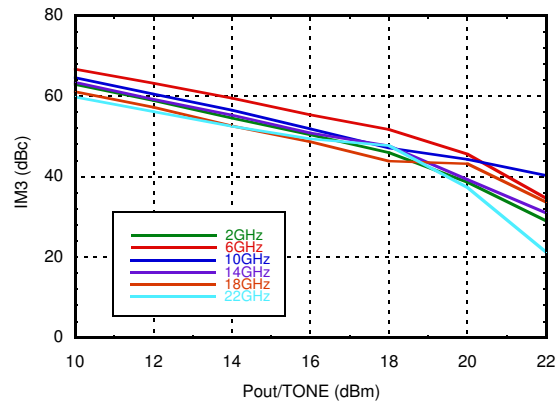

**GaAs pHEMT MMIC
1 WATT POWER AMPLIFIER, DC - 22 GHz**

Output IM3 @ Vdd = +10 V

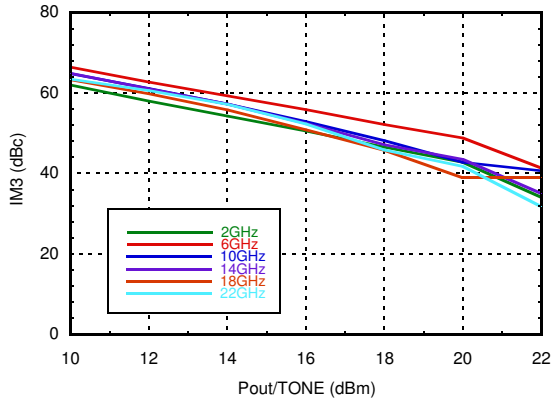

Output IM3 @ Vdd = +11 V

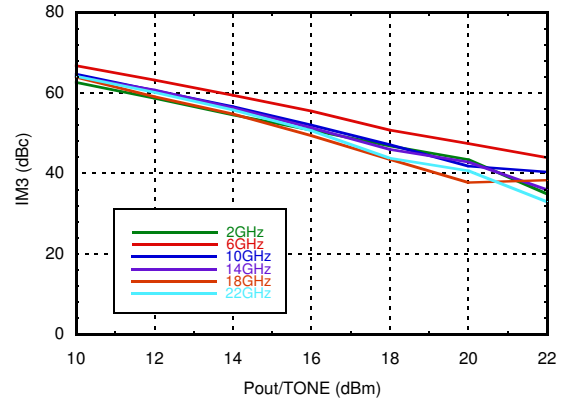

**OIP2 vs. Temperature
@ Pout / Tone = +18 dBm**

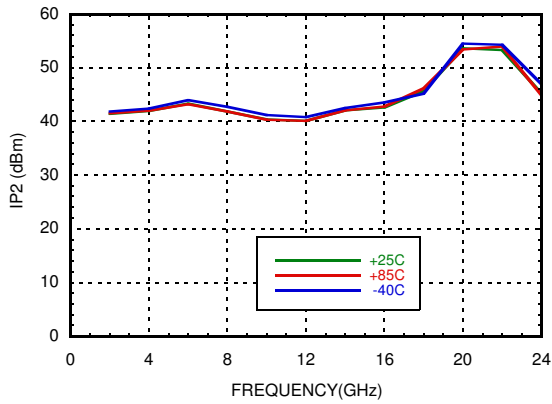

**OIP2 vs. Vdd
@ Pout / Tone = +18 dBm**

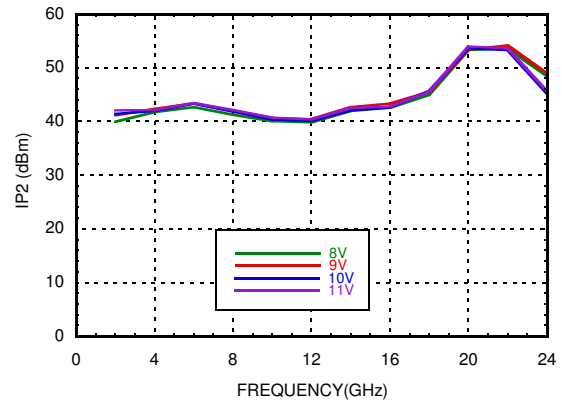

**OIP2 vs. Idd
@ Pout / Tone = +18 dBm**

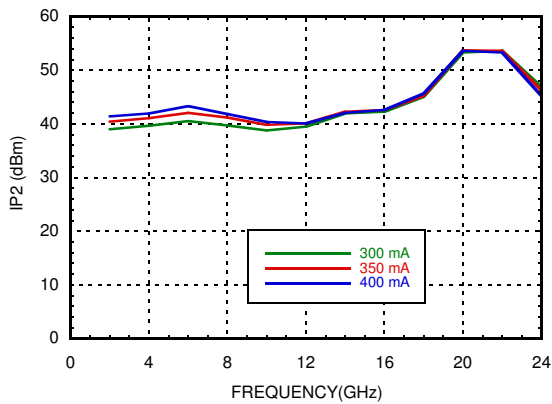

**Second Harmonics vs. Temperature
@ Pout = +18 dBm**

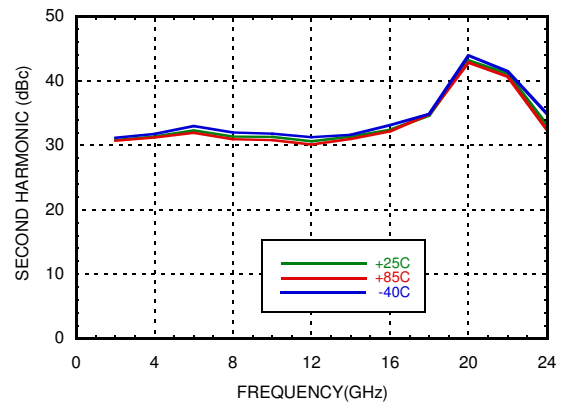

**GaAs pHEMT MMIC
1 WATT POWER AMPLIFIER, DC - 22 GHz**

**Second Harmonics vs. Vdd
@ Pout = +18 dBm**

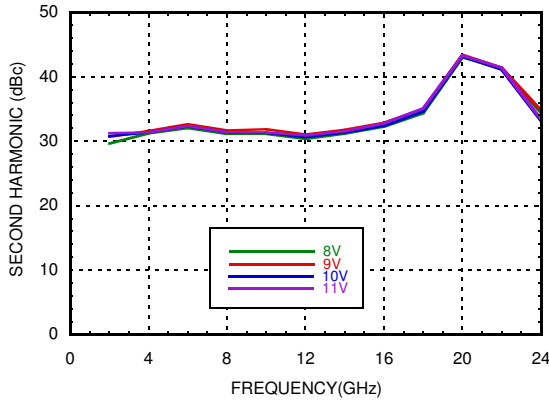

**Second Harmonics vs. Idd
@ Pout = +18 dBm**

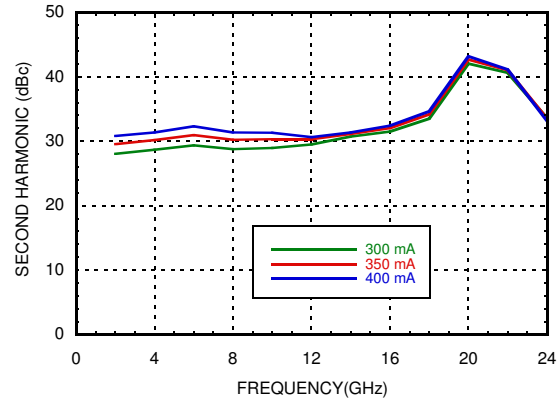

Second Harmonics vs. Pout

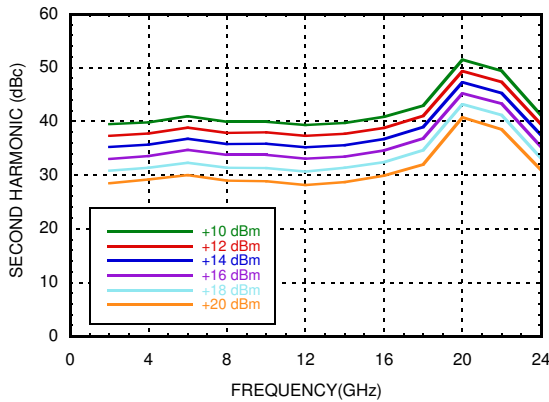

Igg1 vs. Input Power

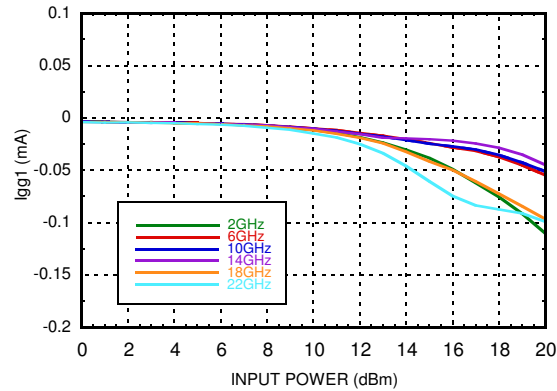

Igg2 vs. Input Power

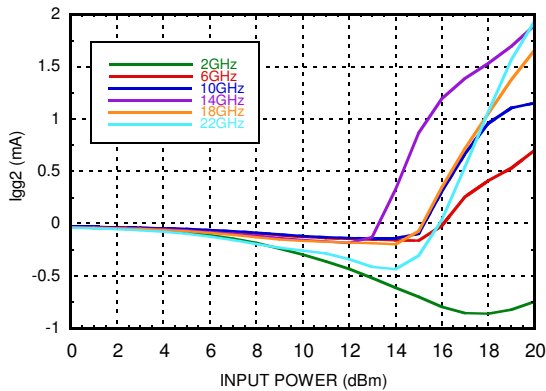

**Idd vs. Vgg1,
Representative of a Typical Device**

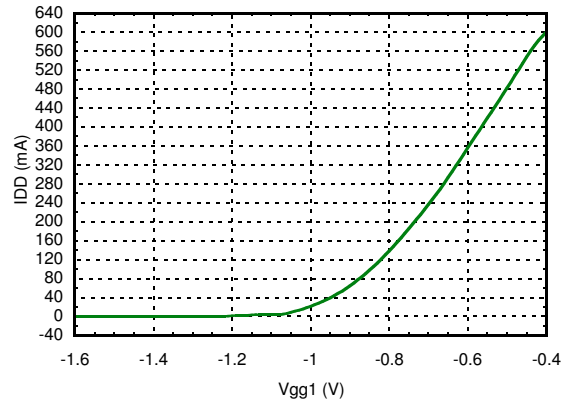

GaAs pHEMT MMIC 1 WATT POWER AMPLIFIER, DC - 22 GHz

Absolute Maximum Ratings

| | |
|--|-------------------------|
| Nominal Drain Supply to GND | +12.0 V |
| Gate Bias Voltage (Vgg1) | -3.0 to 0 Vdc |
| Gate Bias Voltage (Vgg2) | +2.5 V to (Vdd - 6.5 V) |
| Continuous P _{diss} (T= 85 °C) (derate 60 mW/°C above 85 °C) | 5.37 W |
| RF Input Power | +27 dBm |
| Output Load VSWR | 7:1 |
| Storage Temperature | -65 to 150 °C |
| Operating Temperature | -40 to +85 °C |
| Max Peak Reflow Temperature | 260 °C |
| ESD Sensitivity (HBM) | Class 1A - Passed 250V |

Reliability Information

| | |
|---|------------|
| Maximum Junction Temperature | 175 °C |
| Nominal Junction Temperature (T=85 °C, Vdd = 10 V) | 152 °C |
| Thermal Resistance (channel to ground paddle) | 16.75 °C/W |

Stresses at or above those listed under Absolute Maximum Ratings may cause permanent damage to the product. This is a stress rating only, functional operation of the product at these or any other conditions above those indicated in the operational section of this specification is not implied. Operation beyond the maximum operating conditions for extended periods may affect product reliability.



ELECTROSTATIC SENSITIVE DEVICE
OBSERVE HANDLING PRECAUTIONS

Outline Drawing

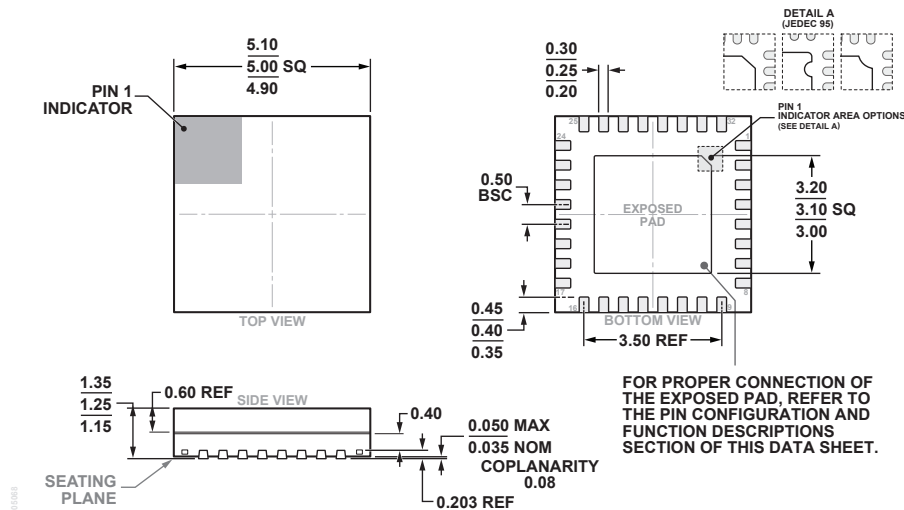

32-Lead Lead Frame Chip Scale Package [LFCSP_CAV]
5 mm x 5 mm and 1.25 mm Package Height
(CG-32-2)
Dimensions shown in millimeters

Package Information

| Part Number | Package Body Material | Lead Finish | MSL Rating | Package Marking |
|-------------|--|-------------|------------|-----------------|
| HMC797APM5E | RoHS-compliant Low Stress Pre-Molded Plastic | NiPdAu | MSL3 [1] | HMC797A |

[1] Max peak reflow temperature of 260 °C

GaAs pHEMT MMIC 1 WATT POWER AMPLIFIER, DC - 22 GHz

Pin Descriptions

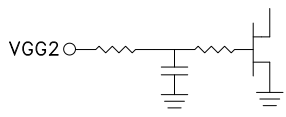
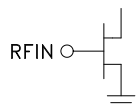
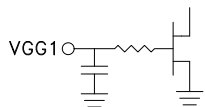
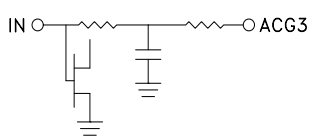
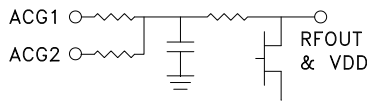
| Pin Number | Function | Description | Interface Schematic |
|---|-------------|--|---|
| 1, 4, 6, 8, 9, 16, 17, 20, 22, 24, 25, 32 Package Bottom | GND | These pins & exposed ground paddle must be connected to RF/DC ground. |  |
| 2 | VGG2 | Gate control 2 for amplifier. Attach bypass capacitor per application circuit herein. For nominal operation +3.5V should be applied to Vgg2. |  |
| 3, 7, 10 - 12, 14, 18, 19, 23, 26 - 28, 31 | N/C | No connection required. These pins may be connected to RF/DC ground without affecting performance. | |
| 5 | RFIN | This pad is DC coupled and matched to 50 Ohms. Blocking capacitor is required. |  |
| 13 | VGG1 | Gate control 1 for amplifier. Attach bypass capacitor per application circuit herein. Please follow "MMIC Amplifier Biasing Procedure" application note. |  |
| 15 | ACG3 | Low frequency termination. Attach bypass capacitor per application circuit herein. |  |
| 21 | RFOUT & VDD | RF output for amplifier. Connect DC bias (Vdd) network to provide drain current (Idd). See application circuit herein. |  |
| 29 | ACG2 | Low frequency termination. Attach bypass capacitor per application circuit herein. | |
| 30 | ACG1 | | |

GaAs pHEMT MMIC 1 WATT POWER AMPLIFIER, DC - 22 GHz

Evaluation PCB

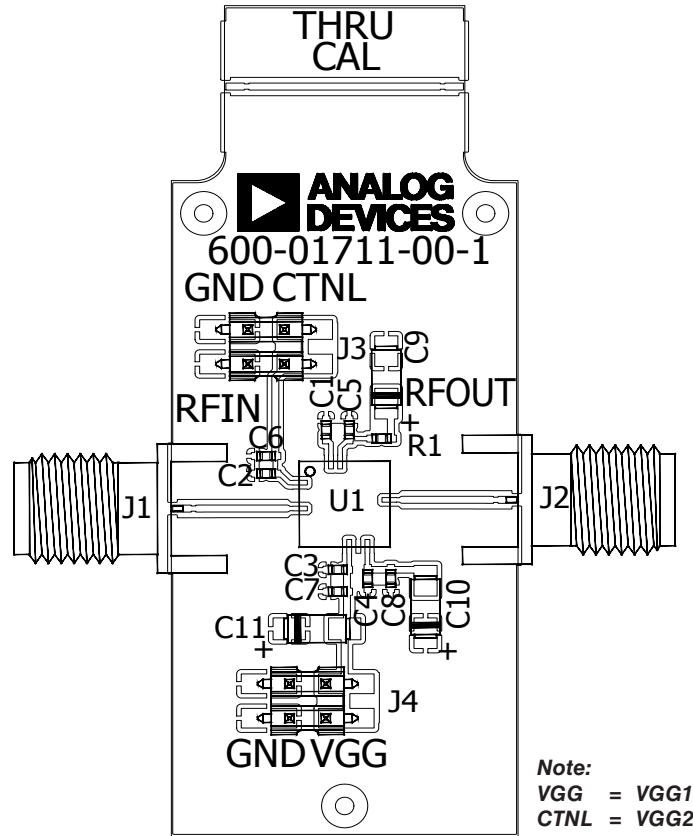

Evaluation Order Information

| Item | Contents | Part Number |
|---------------------|----------------------------|---------------|
| Evaluation PCB only | HMC797APM5E Evaluation PCB | EV1HMC797APM5 |

List of Materials for Evaluation Board

| Item | Description |
|----------|---------------------------------|
| J1, J2 | SMA Connectors |
| J3, J4 | DC Pins |
| C1 - C4 | 100 pF Capacitor, 0402 Pkg. |
| C5, C8 | 10 kpF Capacitor, 0402 Pkg. |
| C9 - C11 | 4.7 μ F Capacitor, Tantalum |
| R1, R2 | 0 OHM Resistor, 0402 Pkg |
| U1 | HMC797APM5E Power Amplifier |
| PCB [1] | 600-01711-00 Evaluation PCB |

[1] Circuit Board Material: Rogers 4350 or Arlon FR4

The circuit board used in the application should use RF circuit design techniques. Signal lines should have 50 Ohm impedance while the package ground leads and exposed paddle should be connected directly to the ground plane similar to that shown. A sufficient number of via holes should be used to connect the top and bottom ground planes. The evaluation board should be mounted to an appropriate heat sink. The evaluation circuit board shown is available from Analog Devices, Inc.

**GaAs pHEMT MMIC
1 WATT POWER AMPLIFIER, DC - 22 GHz**

Application Circuit

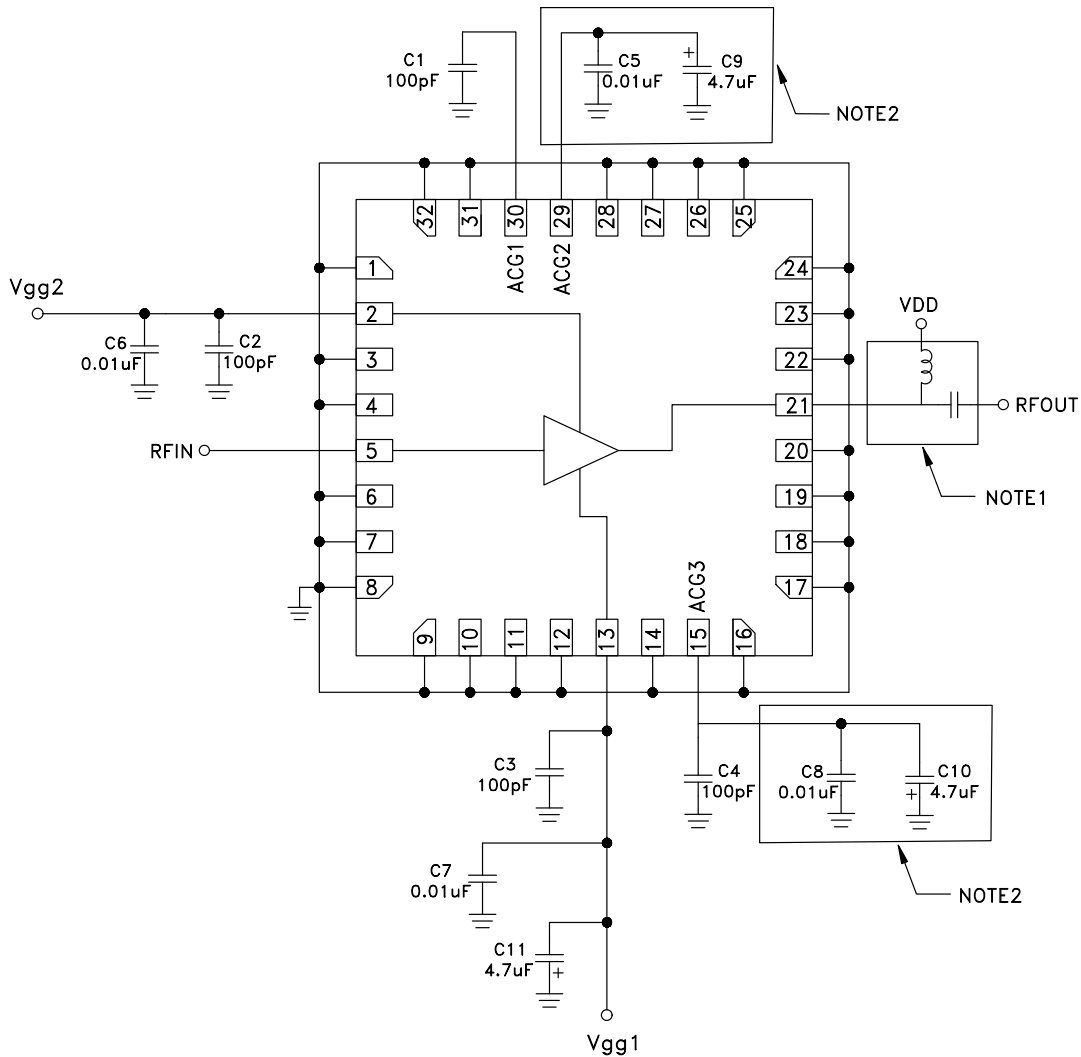

NOTE 1: Drain Bias (Vdd) must be applied through a broadband bias tee or external bias network.

NOTE 2: Optional Capacitors to be used if part is to be operated below 200MHz.

Looking for pricing, stock, or lifecycle information?

Click below to explore more details on WIN SOURCE:

 [View HMC797APM5ETR-R5 on WIN SOURCE](#)

 [Analog Devices Inc. Information](#)

Optimize Your Supply Chain with WIN SOURCE Solutions

-  Global Sourcing Solution
-  Obsolete Management
-  Cost Control Management
-  Shortage Management
-  Alternative Solution
-  Excess Inventory Management