

Product Overview

Qorvo's TGA4549-SM is a high frequency, high power MMIC amplifier fabricated on Qorvo's production 0.15um GaN on SiC process (QGaN15). The TGA4549-SM operates from 21.2 – 23.6 GHz and typically provides 10 W saturated output power with power-added efficiency of 20% and large-signal gain of 17 dB. This combination of high frequency performance provides the flexibility designers are looking for to improve system performance while reducing size and cost. The TGA4549-SM also has an integrated power detector to support system diagnostics and other needs.

The TGA4549-SM is offered in a small 5x5.5 mm surface mount package, matched to 50Ω with integrated DC blocking capacitors on both RF ports simplifying system integration. The frequency coverage and operational flexibility allows it support satellite communication as well as point to point data links.

The TGA4549-SM is 100% DC and RF on-wafer tested to ensure compliance to electrical specifications.

Lead-free and RoHS compliant.

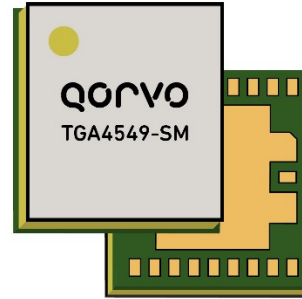

24-Lead 5.0 x 5.5 x 1.7 mm Air Cavity Laminate Package

Key Features

- Frequency Range: 21.2 – 23.6 GHz
- P_{SAT} ($P_{IN}=23$ dBm): 40 dBm
- PAE ($P_{IN}=23$ dBm): 20 %
- Small Signal Gain: 22 dB
- Large Signal Gain: 17 dB
- Integrated Power Detector
- Bias: $V_{D1} = V_{D2} = V_{D3} = +28$ V, $I_{D1} + I_{D2} + I_{D3} = 300$ mA
- Package Dimensions: 5.0 x 5.5 x 1.7 mm

Performance is typical across frequency. Please reference electrical specification table and data plots for more details.

Functional Block Diagram

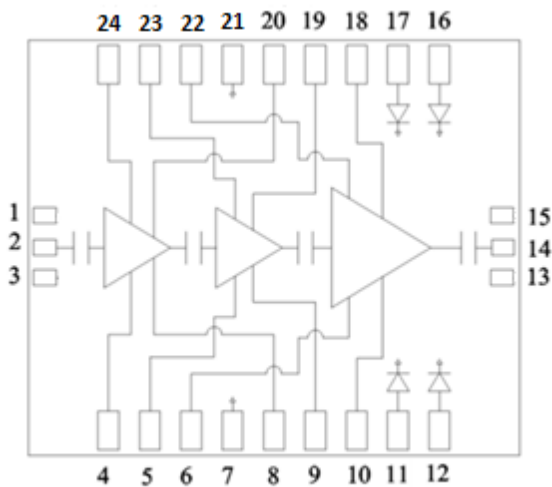

Applications

- Point-to-Point Radio
- Satellite Communications

Ordering Information

Part No.	Description
TGA4549-SM	21.2 – 23.6 GHz 10 W GaN PA
TGA4549-SMTR7	200 pieces on a 7" reel (standard)
TGA4549-SMEVB01	Evaluation Board

Absolute Maximum Ratings

Parameter	Rating
Drain Voltage (V_D)	29.5 V
Gate Voltage Range (V_G)	-8 to 0 V
Drain Current Stage 1 (I_{D1}), Top or Bottom	500 mA
Drain Current Stage 2 (I_{D2}), Top or Bottom	500 mA
Drain Current Stage 3 (I_{D3}), Top and Bottom	2 A
Gate Current (I_G),	See chart
RF Input Power, CW, 50 Ω , $T=25^\circ\text{C}$	26 dBm
Dissipated Power (P_{DISS}), CW, 85°C	45 W
Reference Diode Current (I_{ref})	4 mA
Detector Diode Current (I_{det})	4 mA
Storage Temperature	-55 to $+150^\circ\text{C}$
Mounting Temperature (30 seconds)	260°C

Exceeding any one or a combination of the Absolute Maximum Rating conditions may cause permanent damage to the device. Extended application of Absolute Maximum Rating conditions to the device may reduce device reliability.

Recommended Operating Conditions

Parameter	Min	Typ	Max	Units
Drain Voltage (V_D)		+28		V
Drain Current, Quiescent (I_{DQ})		300		mA
Drain Current, RF (I_{D_Drive})	See chart page 5			mA
Gate Voltage Typ. Range (V_G)	-2.1 to -2.8			V
Gate Current, RF (I_{G_Drive})	See chart page 5			mA
Operating Temp. Range	-40	+25	+85	$^\circ\text{C}$

Electrical specifications are measured at specified test conditions. Specifications are not guaranteed over all recommended operating conditions.

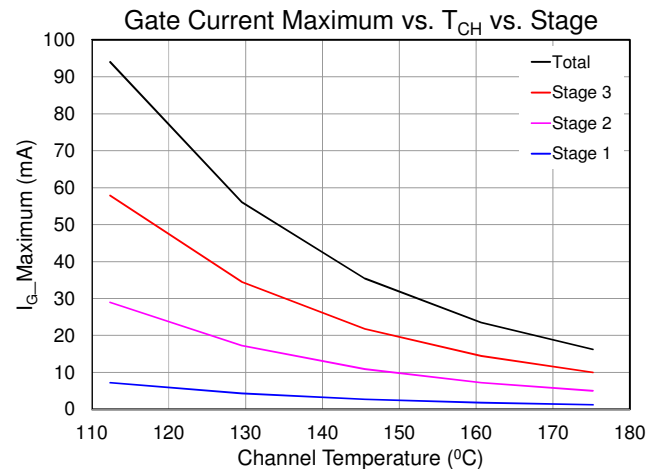

Electrical Specifications

Parameter	Conditions ^{(1) (2)}	Min	Typ	Max	Units
Operational Frequency Range		21.2		23.6	GHz
Small Signal Gain, S21			22		dB
Input Return Loss, IRL			9		dB
Output Return Loss, ORL			12		dB
Output Power at Saturation, P_{SAT}	$P_{IN} = +23$ dBm		40		dBm
Power Added Efficiency, PAE	$P_{IN} = +23$ dBm		20		%
Third Order Intermodulation, IM3	$P_{OUT} = +34$ dBm/tone		25		dBc
S21 Temperature Coefficient	$T_{diff} = (85 - (-40))^\circ\text{C}$		-0.03		dB/ $^\circ\text{C}$
P_{SAT} Temperature Coefficient	$T_{diff} = (85 - (-40))^\circ\text{C}$, $P_{in} = +23$ dBm		-0.02		dBm/ $^\circ\text{C}$
Gate Leakage	$V_D = +28$ V, $V_G = -5$ V	-8	-1	0	mA

Notes:

1. Test conditions unless otherwise noted: CW, $V_{D1} = V_{D2} = V_{D3} = 28$ V, $I_{D1} + I_{D2} + I_{D3} = 300$ mA, adjusting $V_{G1} = V_{G2} = V_{G3}$, $T_{BASE} = +25^\circ\text{C}$, $Z_0 = 50 \Omega$
2. T_{BASE} is back side of package

Performance Plots – Large Signal

Test conditions unless otherwise noted: CW, $V_{D1} = V_{D2} = V_{D3} = 28V$, $I_{D1} + I_{D2} + I_{D3} = 300mA$, adjusting $V_{G1} = V_{G2} = V_{G3}$, $T_{BASE} = +25\text{ }^{\circ}C$, $Z_0 = 50\ \Omega$

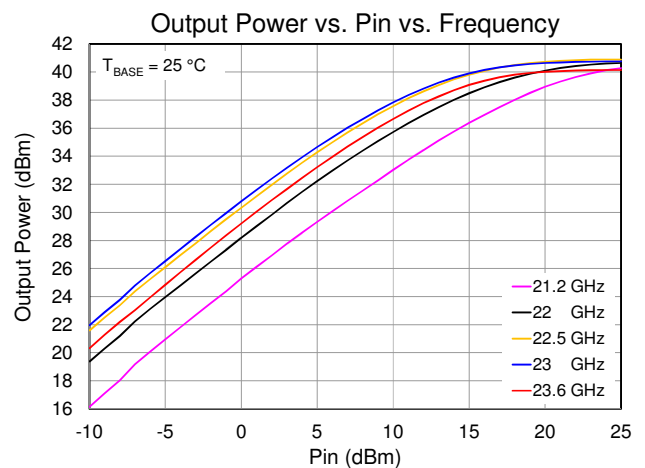
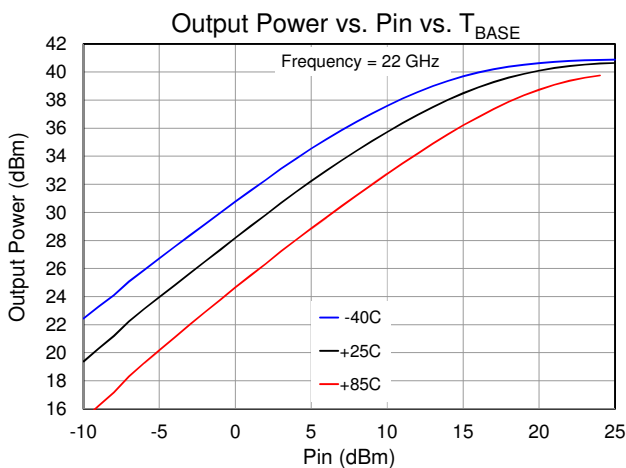
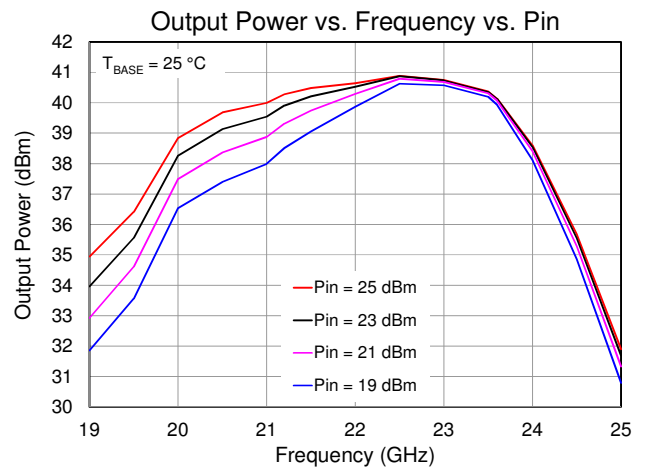
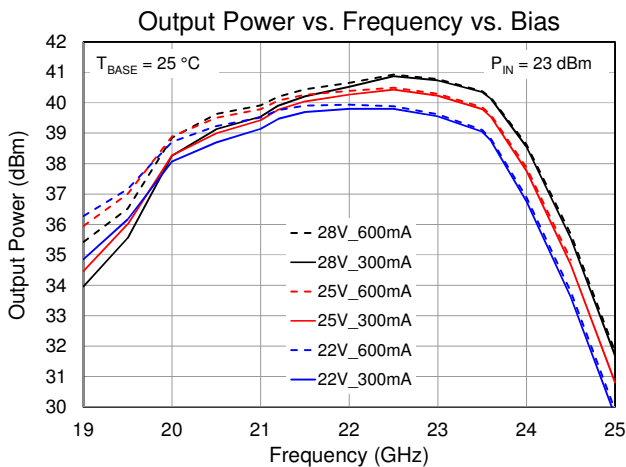
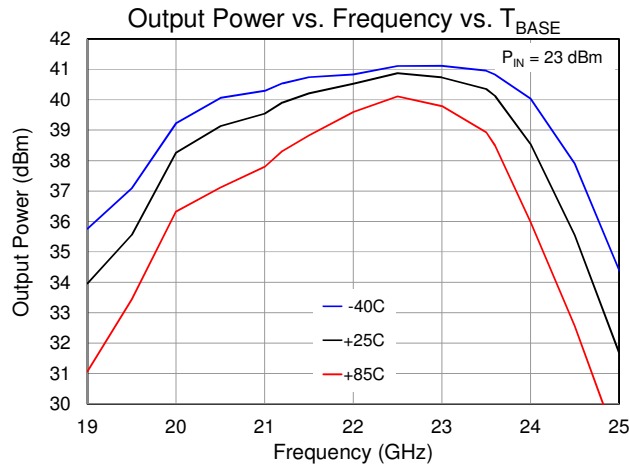

Performance Plots – Large Signal

Test conditions unless otherwise noted: CW, $V_{D1} = V_{D2} = V_{D3} = 28V$, $I_{D1} + I_{D2} + I_{D3} = 300mA$, adjusting $V_{G1} = V_{G2} = V_{G3}$, $T_{BASE} = +25\text{ }^{\circ}C$, $Z_0 = 50\ \Omega$

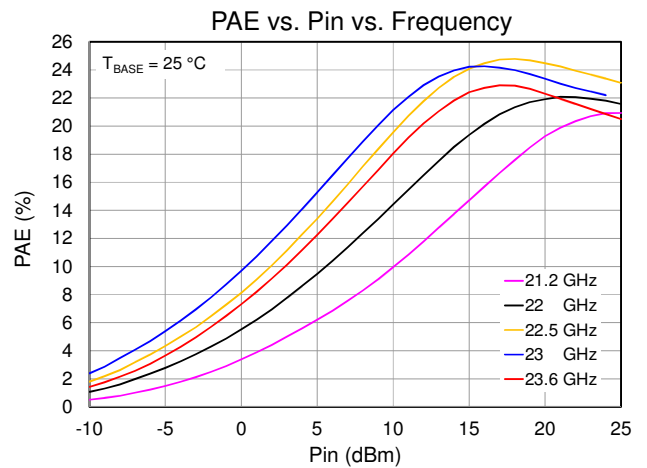
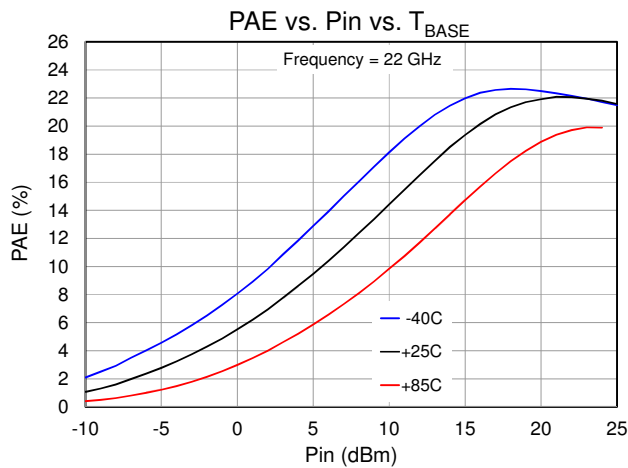
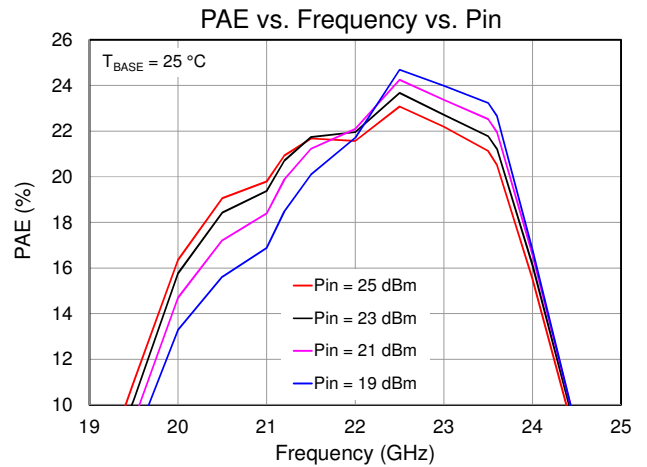
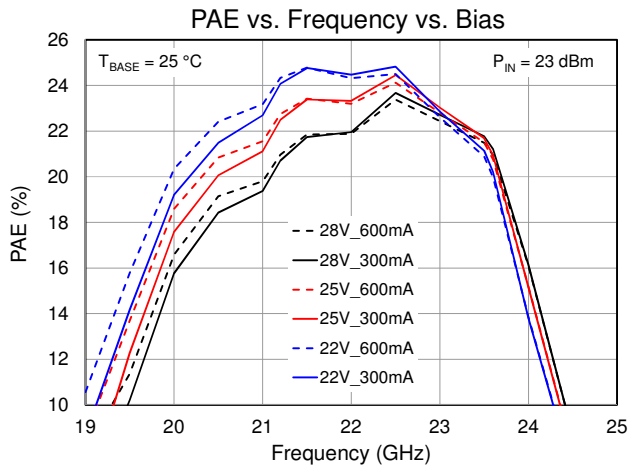
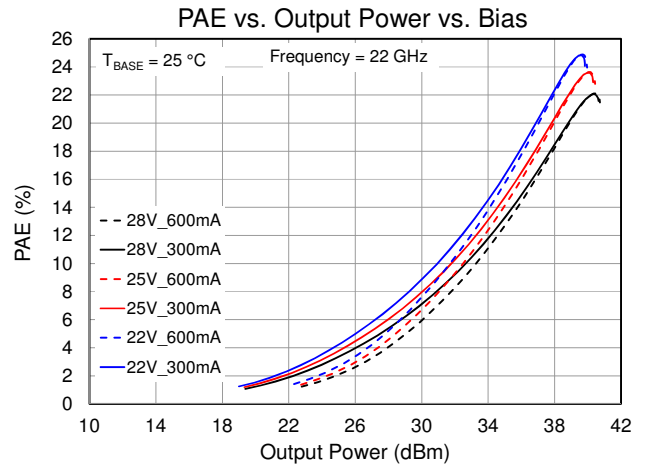
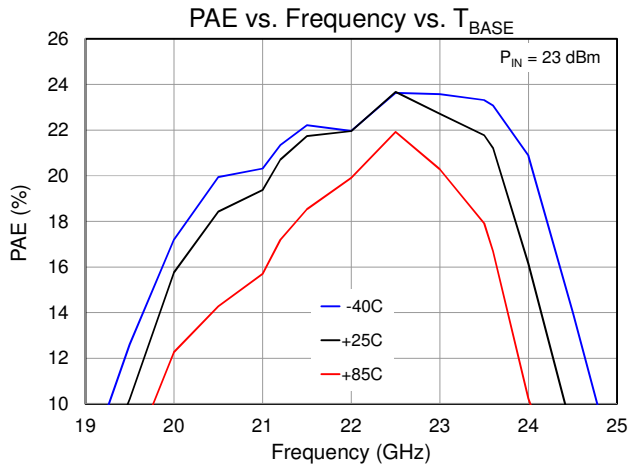

Performance Plots – Large Signal

Test conditions unless otherwise noted: CW, $V_{D1} = V_{D2} = V_{D3} = 28V$, $I_{D1} + I_{D2} + I_{D3} = 300mA$, adjusting $V_{G1} = V_{G2} = V_{G3}$, $T_{BASE} = +25^{\circ}C$, $Z_0 = 50 \Omega$

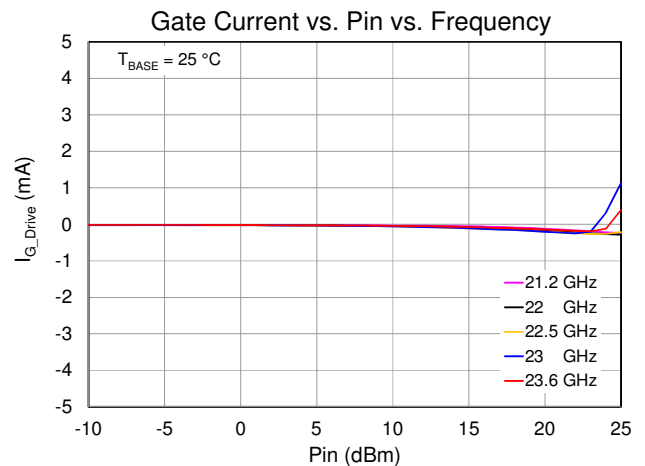
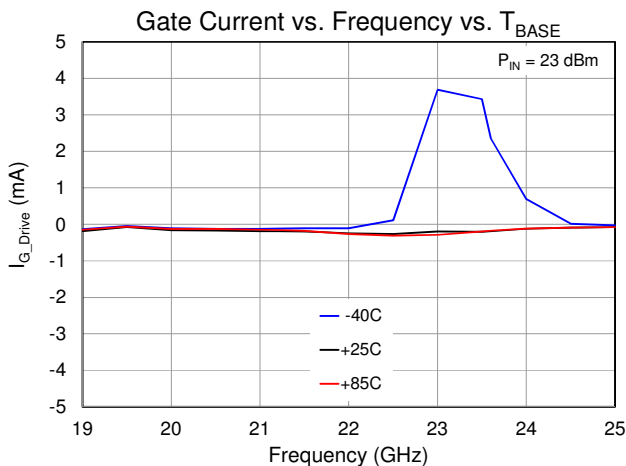
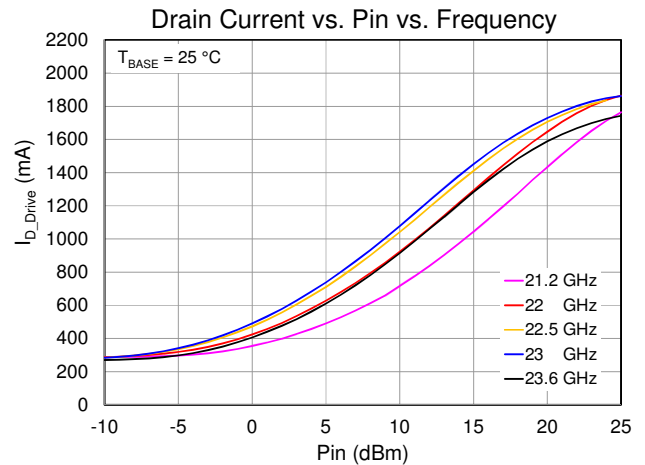
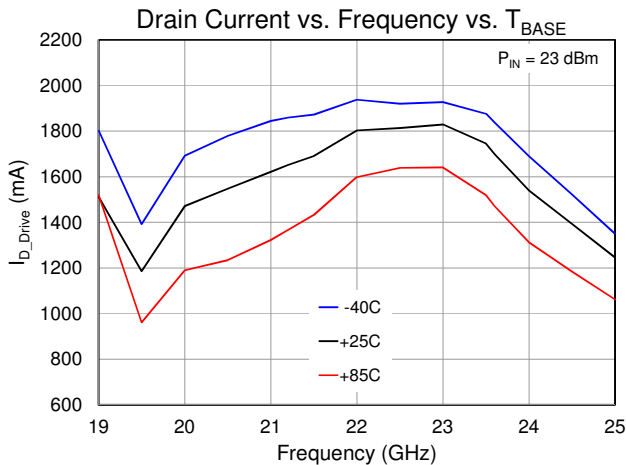
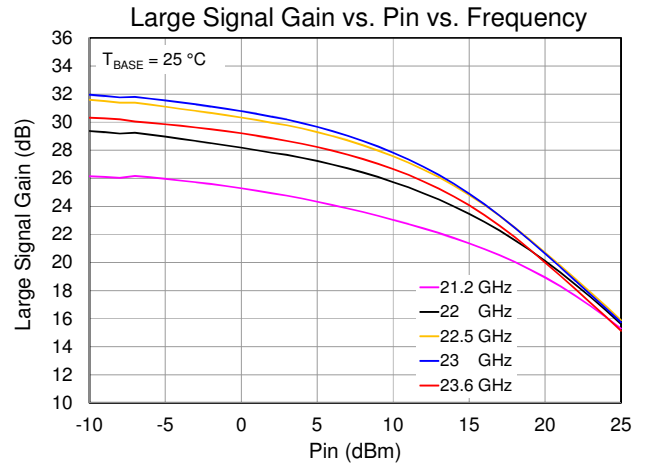
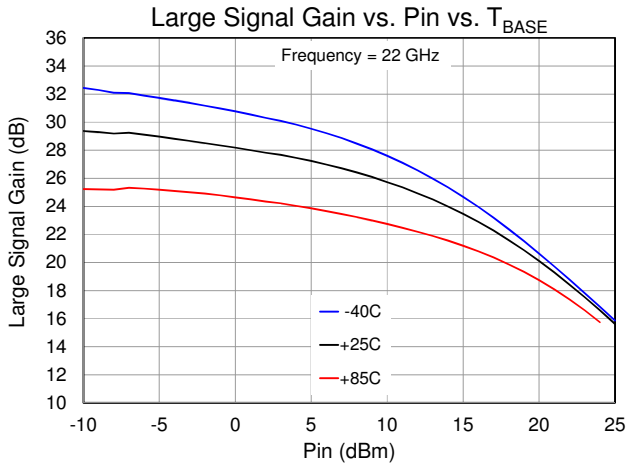

Performance Plots – Large Signal

Test conditions unless otherwise noted: CW, $V_{D1} = V_{D2} = V_{D3} = 28V$, $I_{D1} + I_{D2} + I_{D3} = 300mA$, adjusting $V_{G1} = V_{G2} = V_{G3}$, $T_{BASE} = +25\text{ }^{\circ}C$, $Z_0 = 50\ \Omega$

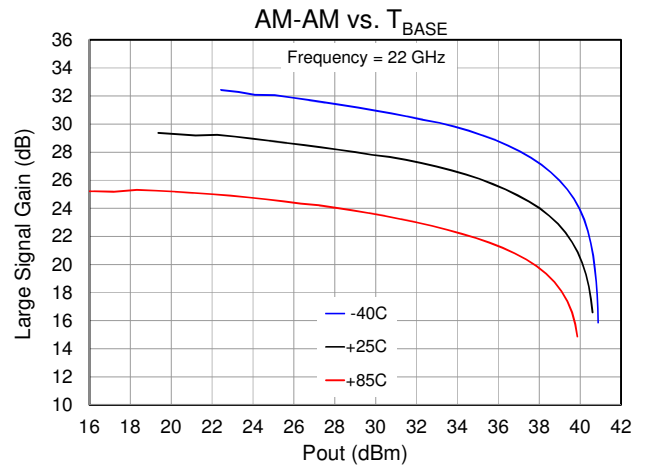
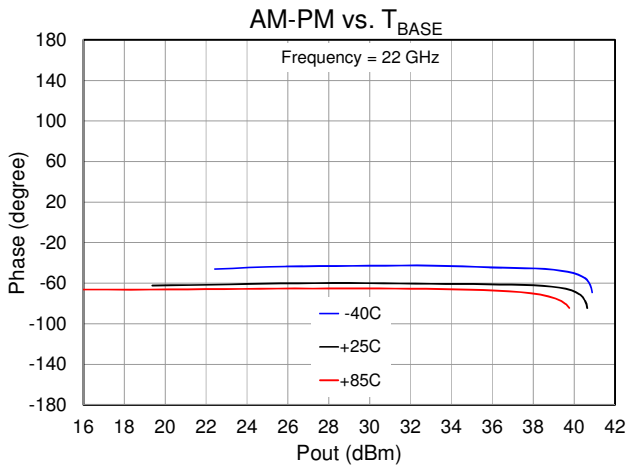
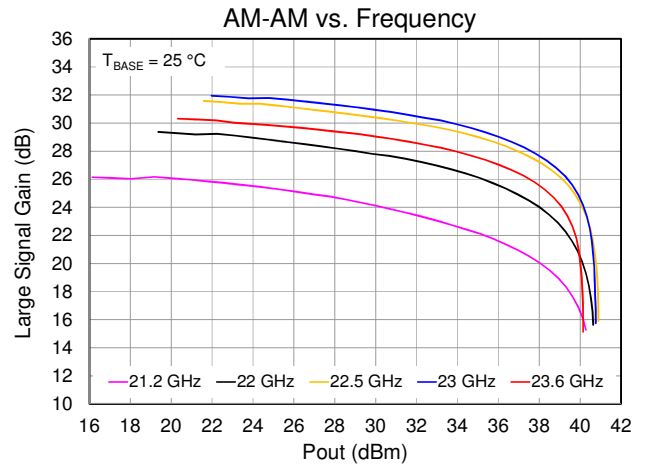
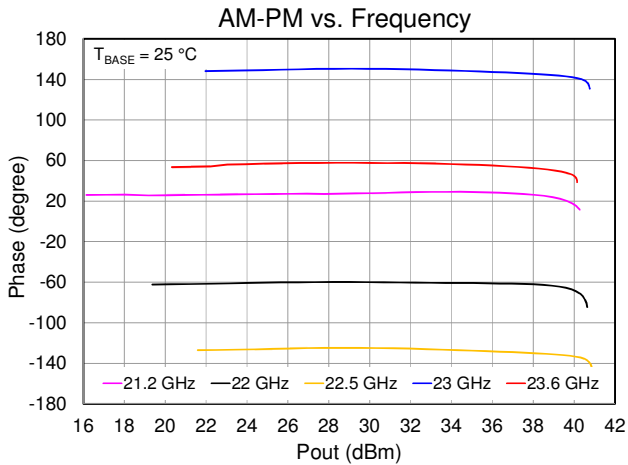

Performance Plots – Power Detector

Test conditions unless otherwise noted: CW, $V_{D1} = V_{D2} = V_{D3} = 28V$, $I_{D1} + I_{D2} + I_{D3} = 300mA$, adjusting $V_{G1} = V_{G2} = V_{G3}$, $T_{BASE} = +25\text{ }^{\circ}C$, $Z_0 = 50\ \Omega$

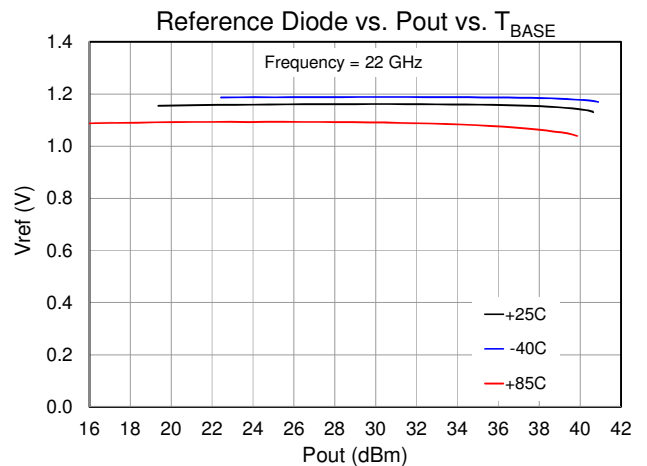
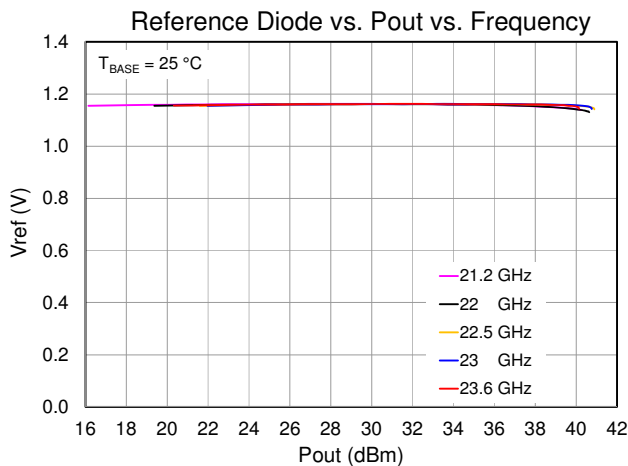
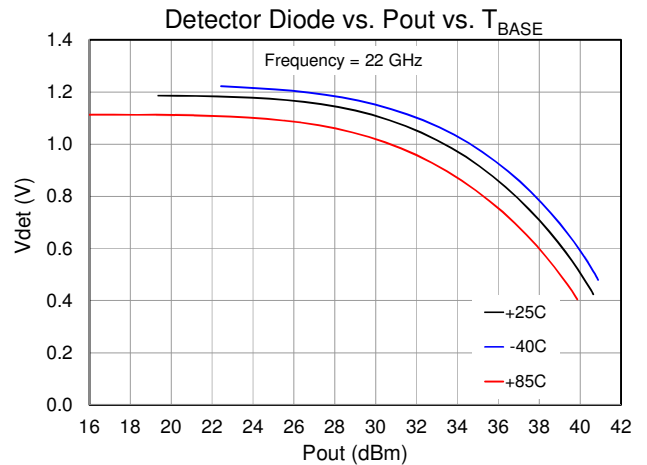
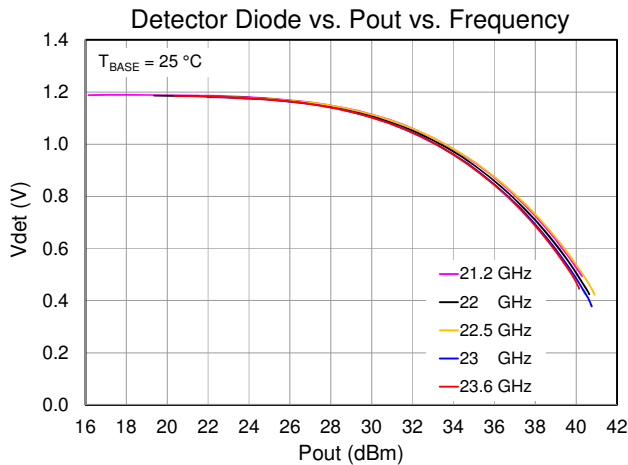
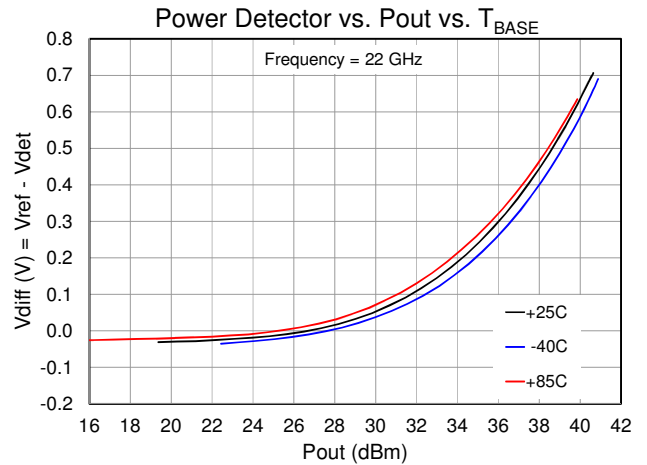
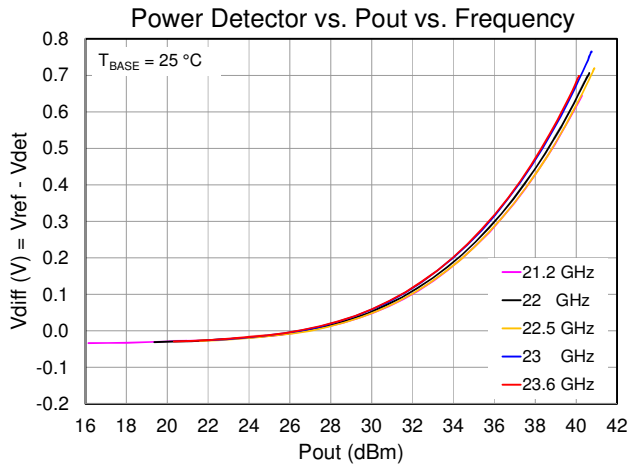

Performance Plots – Linearity

Test conditions unless otherwise noted: CW, $V_{D1} = V_{D2} = V_{D3} = 28V$, $I_{D1} + I_{D2} + I_{D3} = 300mA$, adjusting $V_{G1} = V_{G2} = V_{G3}$, $T_{BASE} = +25\text{ }^{\circ}C$, $Z_0 = 50\ \Omega$

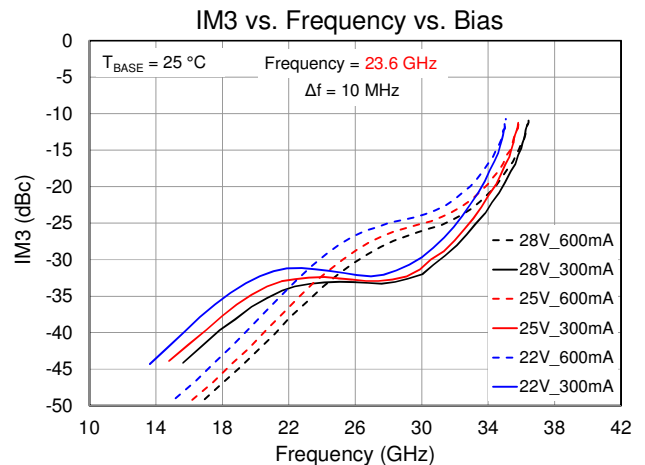
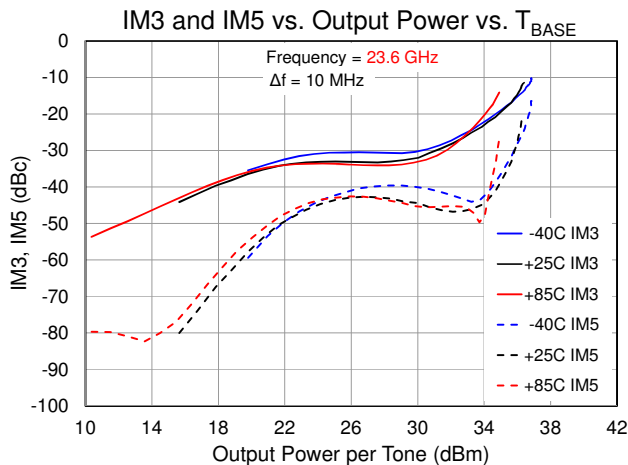
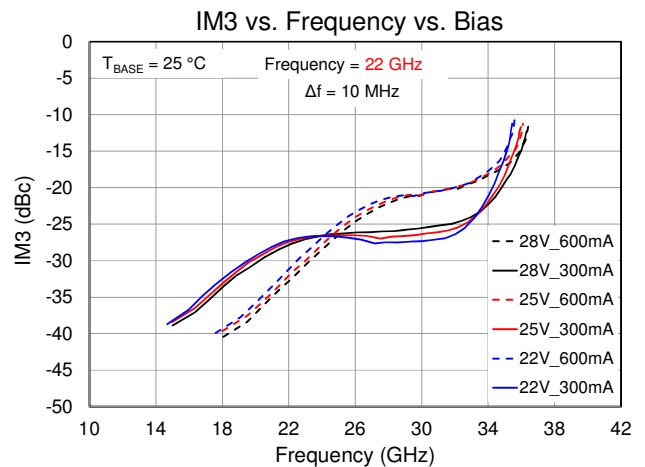
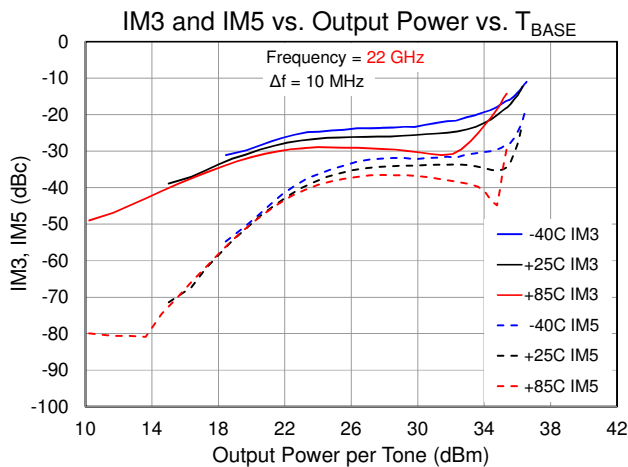
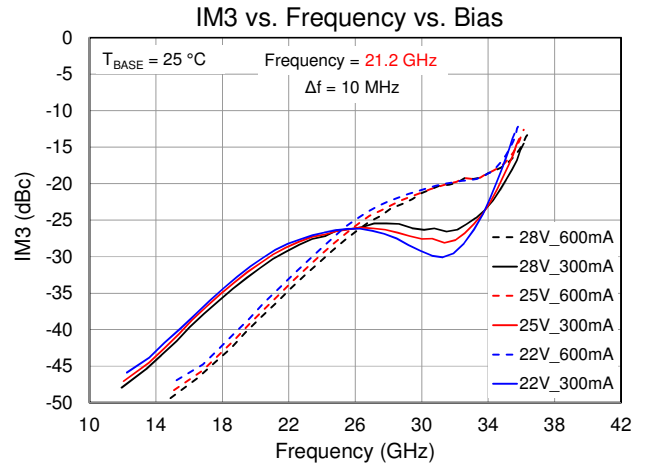
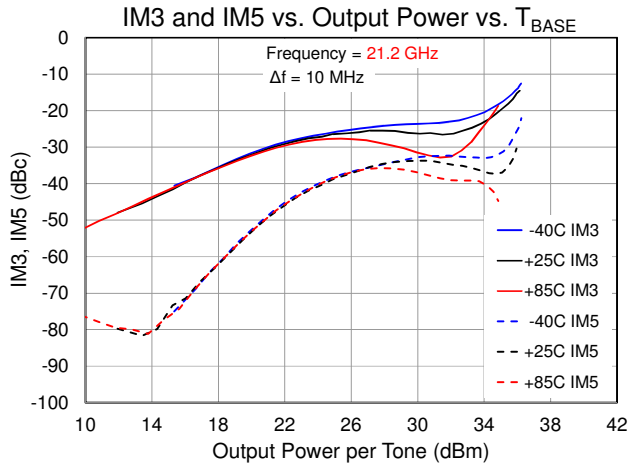

Performance Plots – Small Signal

Test conditions unless otherwise noted: CW, $V_{D1} = V_{D2} = V_{D3} = 28V$, $I_{D1} + I_{D2} + I_{D3} = 300mA$, adjusting $V_{G1} = V_{G2} = V_{G3}$, $T_{BASE} = +25^{\circ}C$, $Z_0 = 50 \Omega$

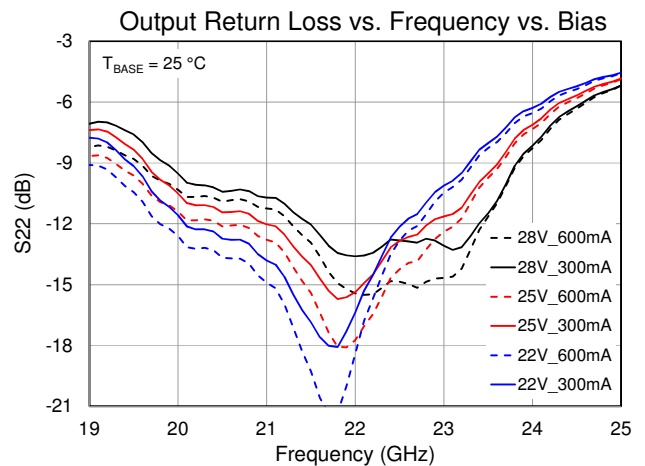
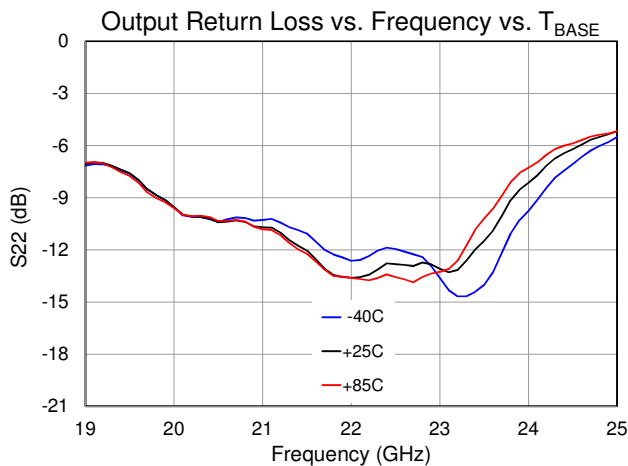
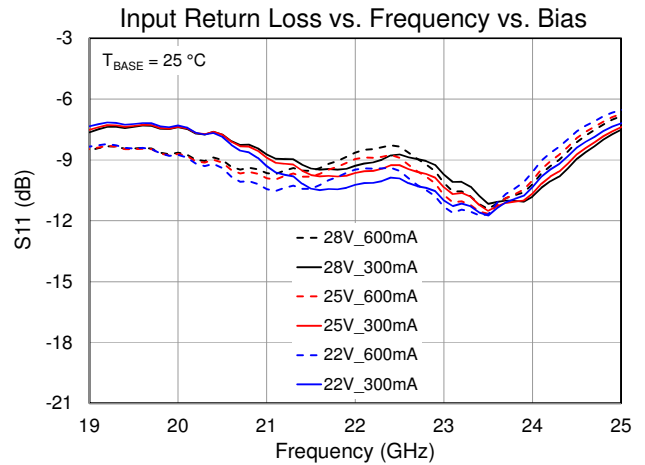
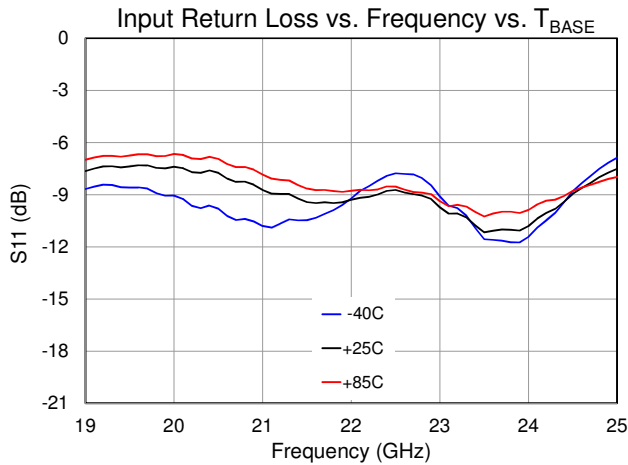
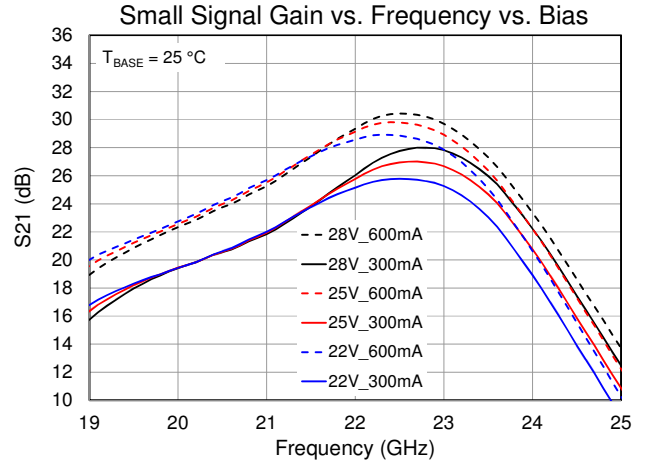
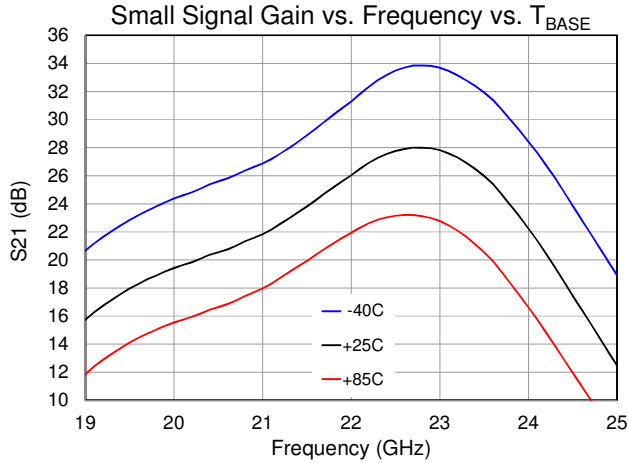

Thermal and Reliability Information

Parameter	Test Conditions	Value	Units
Thermal Resistance (θ_{JC}) ⁽¹⁾	$T_{BASE} = 85\text{ }^{\circ}\text{C}$, $V_D = 28\text{ V}$, $I_{DQ} = 300\text{ mA}$, Freq = 23 GHz, $P_{DISS} = 8.4\text{ W}$	2.38	$^{\circ}\text{C/W}$
Channel Temperature, T_{CH} (Under RF) ⁽²⁾		105	$^{\circ}\text{C}$
Thermal Resistance (θ_{JC}) ⁽¹⁾	$T_{BASE} = 85\text{ }^{\circ}\text{C}$, $V_D = 28\text{ V}$, $I_{DQ} = 300\text{ mA}$, Freq = 2 GHz, $I_{D_DRIVE} \approx 1.64\text{ A}$, $P_{IN} = 23\text{ dBm}$, $P_{OUT} = 40\text{ dBm}$, $P_{DISS} = 36\text{ W}$	2.44	$^{\circ}\text{C/W}$
Channel Temperature, T_{CH} (Under RF) ⁽²⁾		173	$^{\circ}\text{C}$

Notes:

1. Thermal resistance determined to the back of package T_{BASE}
2. Channel temperature indicated is an IR scan equivalent temperature. Thermal resistance is calculated using this value. Additional information can be found in the Qorvo Applications Note "GaN Device TCHMAX Theta-JC and Reliability Estimates," located here <https://www.qorvo.com/products/d/da006480>

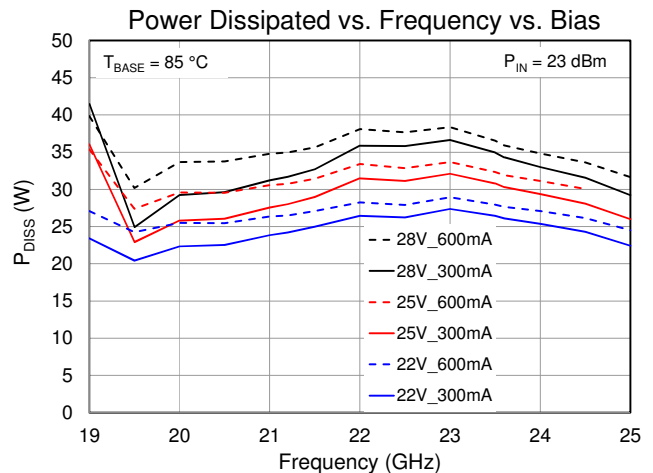
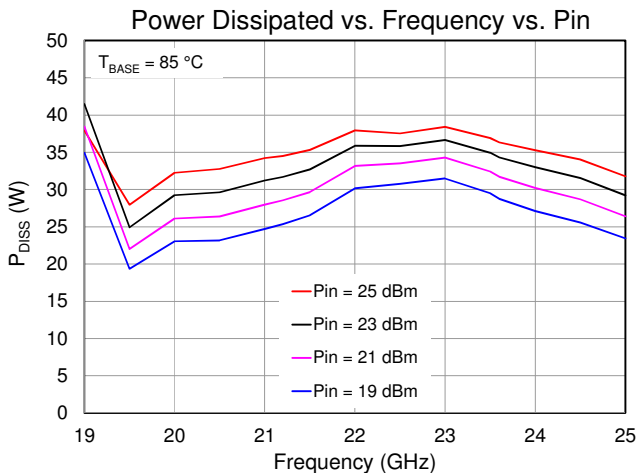
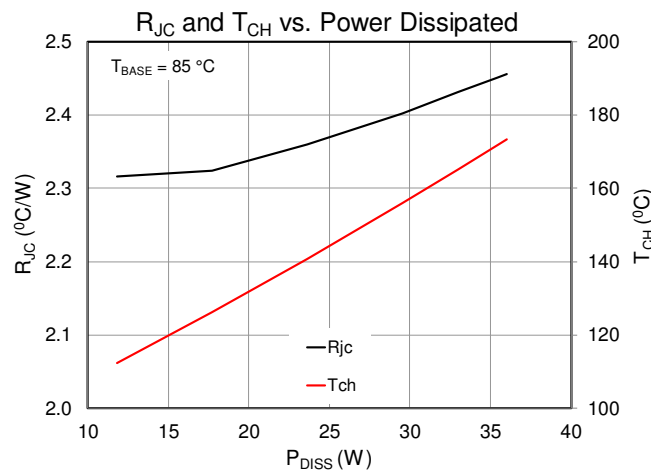

Recommended Application Circuit

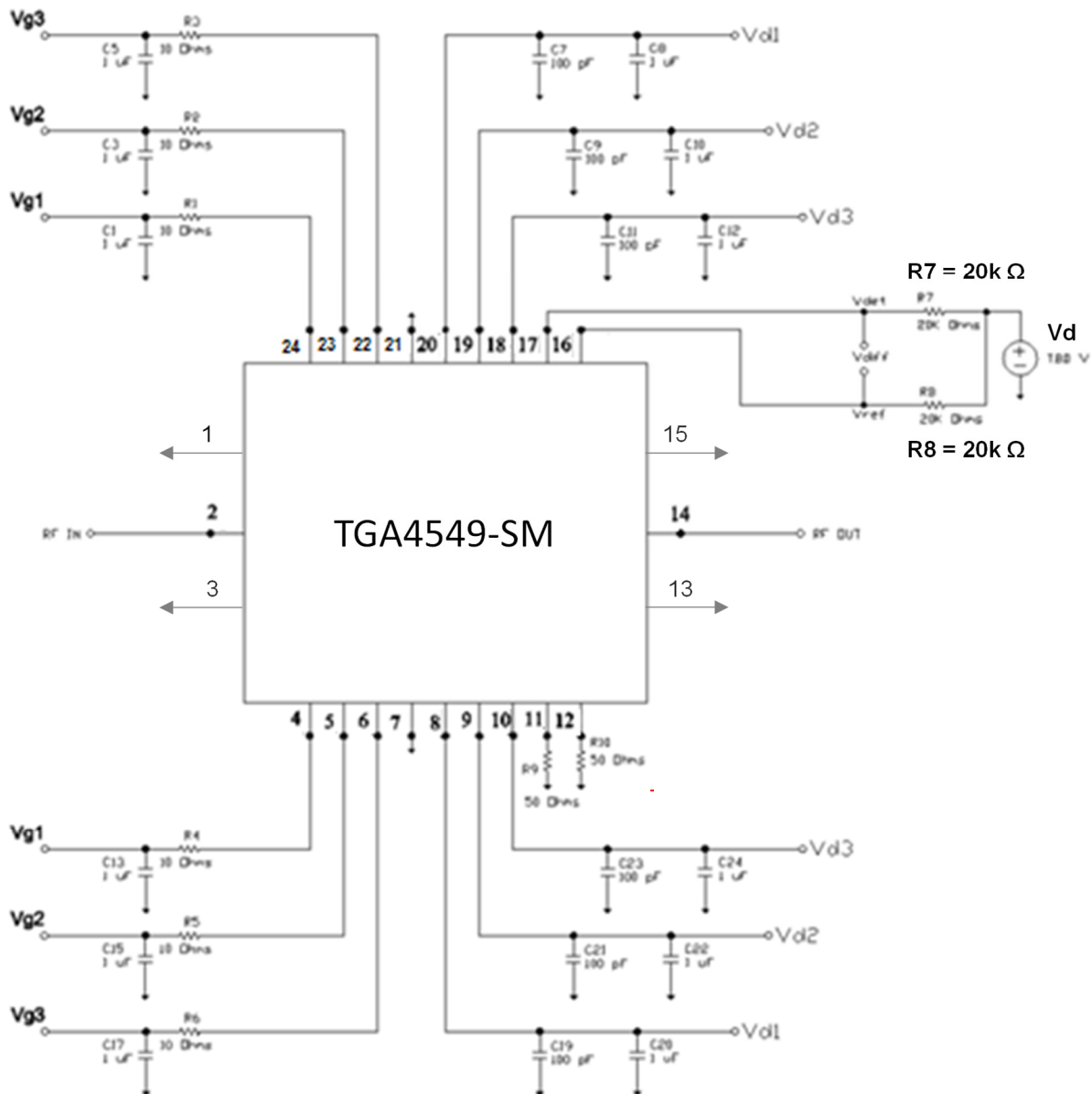

- Notes:
1. V_{G1} , V_{G2} , and V_{G3} can be biased from either top side or bottom side; the non-biased side can be left open but bias network is required.
 2. V_{D1} , V_{D2} , and V_{D3} must be biased from both sides.
 3. Tied all V_D 's together; tied all V_G 's together

Bias Up Procedure

1. Set I_D limit to 3000 mA, I_G limit to 10 mA
2. Apply $-5V$ to V_G
3. Apply $+28V$ to V_D ; ensure I_{DQ} is approx. 0 mA
4. Adjust V_G until $I_{DQ} = 300$ mA ($V_G \sim -2.5 \pm 0.4$ V Typ.).
5. Turn on RF supply

Bias Down Procedure

1. Turn off RF supply
2. Reduce V_G to $-5V$; ensure I_{DQ} is approx. 0 mA
3. Set V_D to 0V
4. Turn off V_D supply
5. Turn off V_G supply

Application Evaluation Board (EVB)

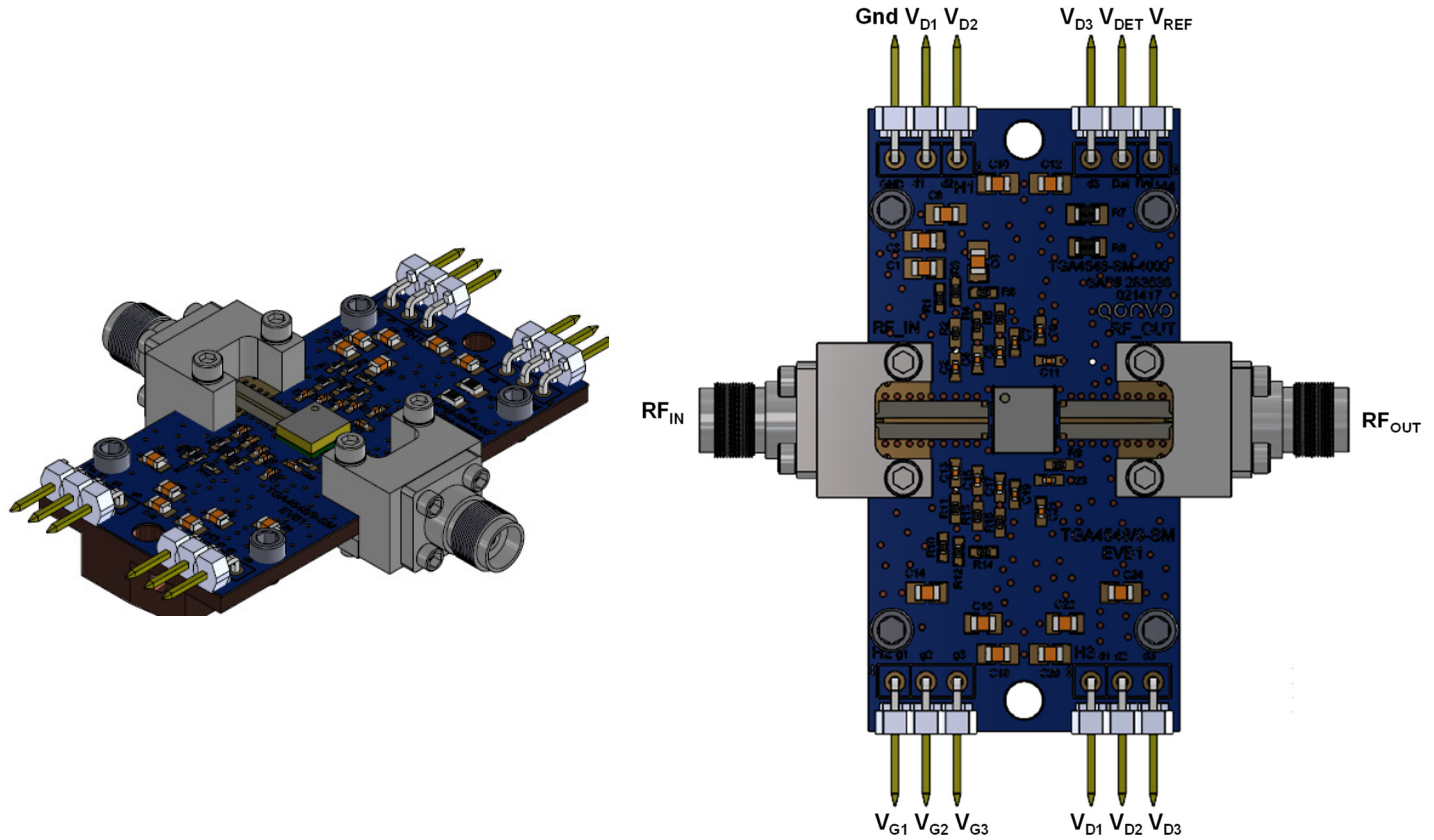

- Notes:
1. Board Material is RO4003 0.008" thickness with ½ oz. copper cladding
 2. Vias under the ground paddle are copper filled.

Bill of Material – Evaluation Board (EVB)

Reference Des.	Value	Description	Manuf.	Part Number
n/a	n/a	Printed Circuit Board	Qorvo	
U1	n/a	17.7 – 19.7 GHz Power Amplifier	Qorvo	TGA4549-SM
C7, C9, C11, C19, C21, C23	100pF	Cap, 0402, 50 V, 5%, COG	various	
C1, C3, C5, C13, C15, C17	1uF	Cap, 0805, 50 V, 5%, X5R	various	
R1-R6	10Ω	Resistor, 0402, 5%, 1/16W, SMD	various	
R7, R8	20kΩ	Resistor, 0805, 5%, SMD	various	
R9	50Ω	Resistor, 0402, 5%, 1/16W, SMD	various	

Pad Configuration and Description

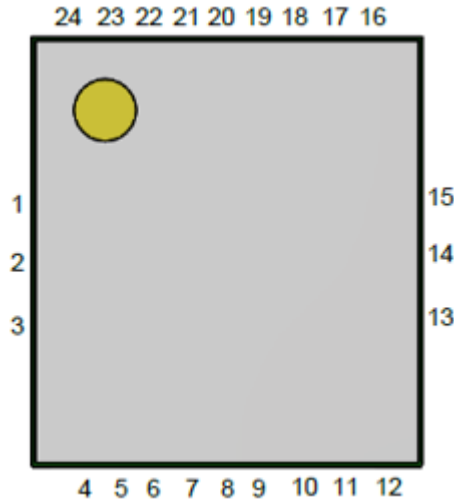

Top View

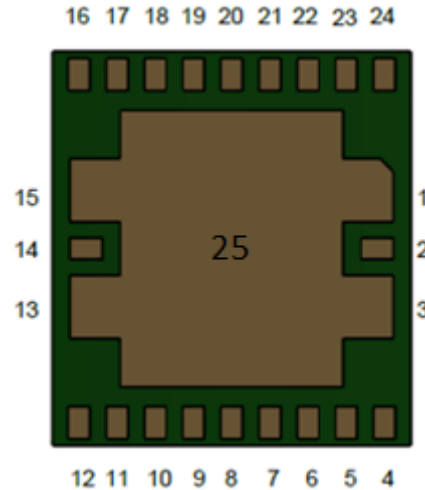

Bottom View

Pad No.	Label	Description
1, 3, 7, 13, 15, 21	GND	Ground. Must be grounded on PCB (same as Pad 25)
2	RF _{IN}	RF input, matched to 50Ω, AC coupled.
4, 24	V _{G1}	Gate voltage, stage 1. Bias network is required; see Recommended Application Circuit on page 12
5, 23	V _{G2}	Gate voltage, stage 2. Bias network is required; see Recommended Application Circuit on page 12
6, 22	V _{G3}	Gate voltage, stage 3. Bias network is required; see Recommended Application Circuit on page 12
8, 20	V _{D1}	Drain voltage, stage 1. Bias network is required; see Recommended Application Circuit on page 12
9, 19	V _{D2}	Drain voltage, stage 2. Bias network is required; see Recommended Application Circuit on page 12
10, 18	V _{D3}	Drain voltage, stage 3. Bias network is required; see Recommended Application Circuit on page 12
11, 17	V _{DET}	Detector diode output voltage. Varies with RF output power.
12, 16	V _{REF}	Reference diode output voltage
14	RF _{OUT}	RF output, matched to 50Ω, AC coupled.
25	GND	Backside paddle. Multiple conductive filled vias should be employed to minimize inductance and thermal resistance; see Mounting Configuration on page 15 for suggested footprint.

Package Marking and Dimensions

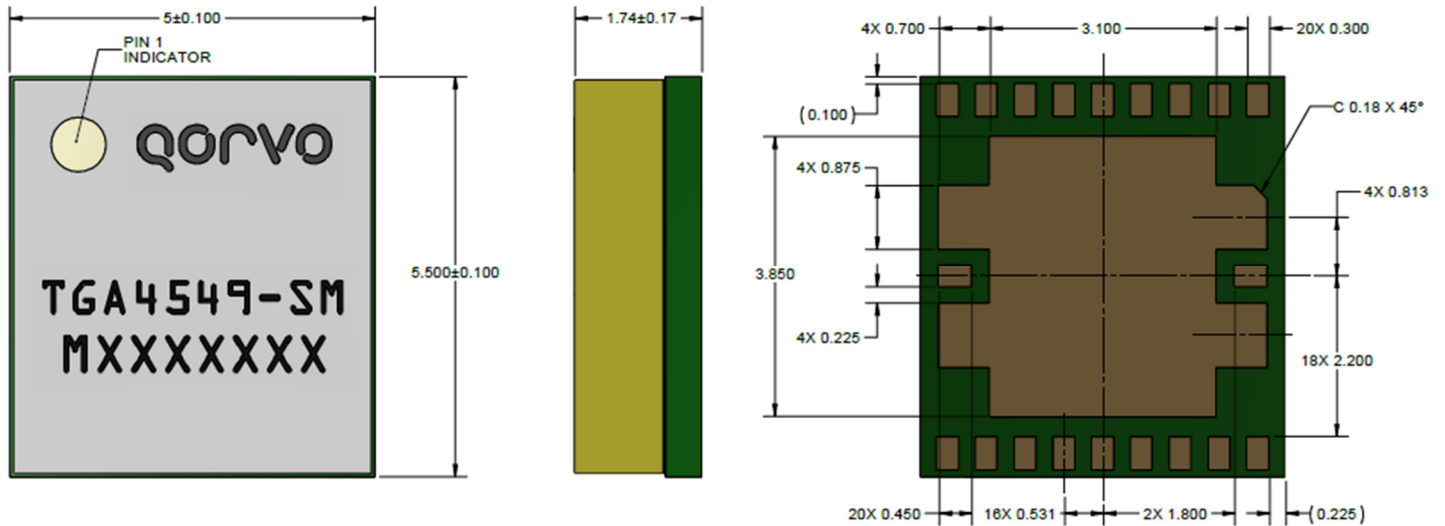

Units: millimeters
 Tolerances: unless specified
 x.xx = ± 0.25 x.xxx = ± 0.100 Angles = 0.5°
 Materials:
 Base: EHS Laminate
 Lid: Laminate
 All metalized features are gold plated; Part is epoxy sealed
 Marking:
 TGA4549-SM: Part number
 MXXXXXXX: where XXXXXXX represents assembly lot number

PCB Mounting Pattern

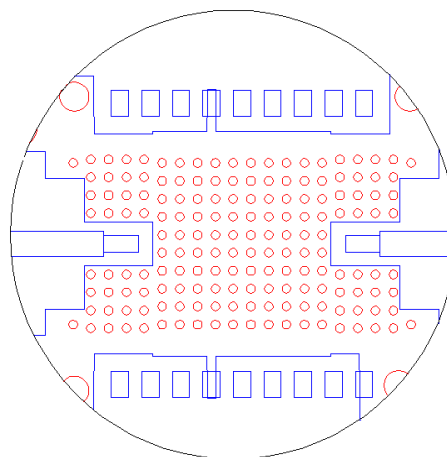

- Notes:
1. All dimensions are in millimeters. Angles are in degrees.
 2. Ground vias are critical for the proper performance of this device. Vias should have a final plated thru diameter of .1524 mm (.006”).
 3. For best thermal performance, vias under the ground paddle should be copper filled.
 4. The pad pattern shown has been developed and tested for optimized assembly at Qorvo. The PCB land pattern has been developed to accommodate lead and package tolerances. Since surface mount processes vary from company to company, careful process development is recommended.

Tape and reel Information

Standard T/R size = 200 pieces on a 7" reel
 Dimensions: millimeters (mm)
 Tolerances unless otherwise noted: .X = ± .2; .XX = ± .10

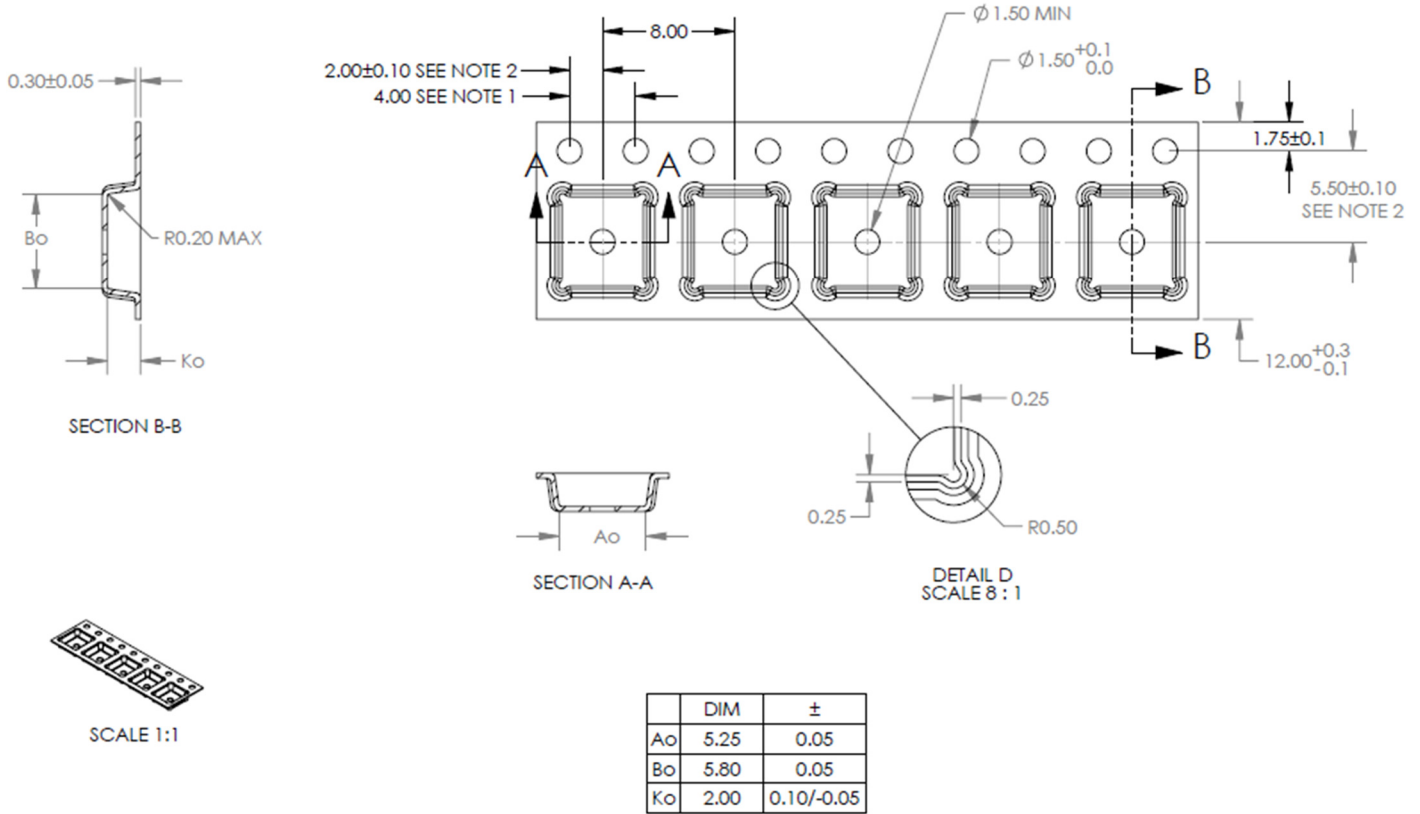

Assembly Notes

Compatible with lead-free soldering processes with 260°C peak reflow temperature.

This package is air-cavity and non-hermetic, and therefore cannot be subjected to aqueous washing. The use of no-clean solder to avoid washing after soldering is highly recommended.

Contact plating: Ni-Au

Solder rework not recommended

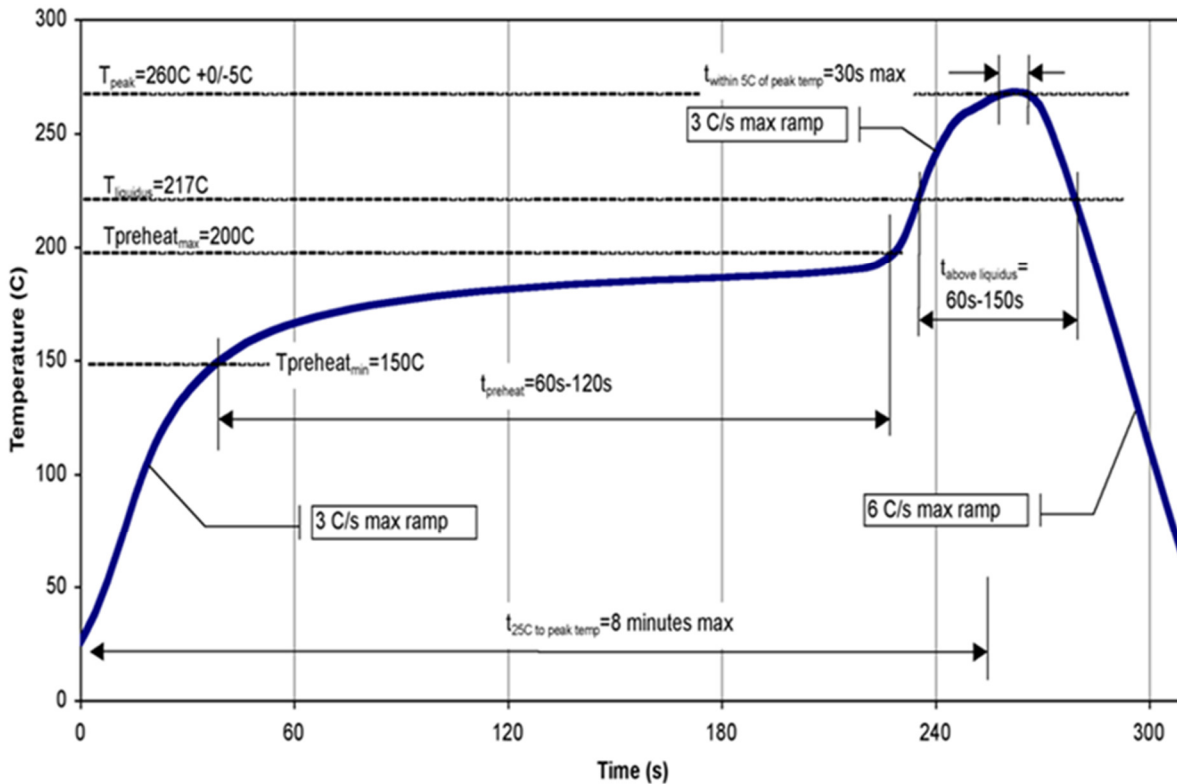

Recommended Soldering Temperature Profile

Handling Precautions

Parameter	Rating	Standard
ESD – Human Body Model (HBM)	1A	ANSI/ESD/JEDEC JS-001
MSL – Moisture Sensitivity Level	3	IPC/JEDEC J-STD-020



Caution!
ESD-Sensitive Device

RoHS Compliance

This part is compliant with 2011/65/EU RoHS directive (Restrictions on the Use of Certain Hazardous Substances in Electrical and Electronic Equipment) as amended by Directive 2015/863/EU.

This product also has the following attributes:

- Lead Free
- Antimony Free
- TBBP-A (C₁₅H₁₂Br₄O₂) Free

Contact Information

For the latest specifications, additional product information, worldwide sales and distribution locations:

Web: www.qorvo.com

Tel: 1-844-890-8163

Email: customer.support@qorvo.com

Important Notice

The information contained herein is believed to be reliable; however, Qorvo makes no warranties regarding the information contained herein and assumes no responsibility or liability whatsoever for the use of the information contained herein. All information contained herein is subject to change without notice. Customers should obtain and verify the latest relevant information before placing orders for Qorvo products. The information contained herein or any use of such information does not grant, explicitly or implicitly, to any party any patent rights, licenses, or any other intellectual property rights, whether with regard to such information itself or anything described by such information. **THIS INFORMATION DOES NOT CONSTITUTE A WARRANTY WITH RESPECT TO THE PRODUCTS DESCRIBED HEREIN, AND QORVO HEREBY DISCLAIMS ANY AND ALL WARRANTIES WITH RESPECT TO SUCH PRODUCTS WHETHER EXPRESS OR IMPLIED BY LAW, COURSE OF DEALING, COURSE OF PERFORMANCE, USAGE OF TRADE OR OTHERWISE, INCLUDING THE IMPLIED WARRANTIES OF MERCHANTABILITY AND FITNESS FOR A PARTICULAR PURPOSE.**

Without limiting the generality of the foregoing, Qorvo products are not warranted or authorized for use as critical components in medical, life-saving, or life-sustaining applications, or other applications where a failure would reasonably be expected to cause severe personal injury or death.

Copyright 2023 © Qorvo, Inc. | Qorvo is a registered trademark of Qorvo, Inc.

Looking for pricing, stock, or lifecycle information?

Click below to explore more details on WIN SOURCE:

 [View TGA4549-SM on WIN SOURCE](#)

 [Qorvo US Inc. Information](#)

Optimize Your Supply Chain with WIN SOURCE Solutions

-  Global Sourcing Solution
-  Obsolete Management
-  Cost Control Management
-  Shortage Management
-  Alternative Solution
-  Excess Inventory Management