

Product Description

The Qorvo TGA2227 is a wideband, low noise amplifier fabricated on Qorvo’s QGaN15 production GaN-on-SiC process. The TGA2227 operates from 2–22 GHz and provides > 15 dB of small signal gain with 2 dB of mid-band noise figure. The TGA2227 can be biased over a wide range of voltage with little impact on noise figure and gain; thus allowing the user to minimize power dissipation depending on power and linearity requirements.

Another key feature is the TGA2227’s high robustness to incident power. Able to handle 40 dBm without performance degradation makes the TGA2227 an ideal choice for a front-end LNA. Depending on the application, this level of robustness could easily support the elimination of other receive protect circuitry. This would further support a more simplified board design, reduced BOM costs and lower overall noise figure.

Supported applications span both commercial and military communication and radar systems as well as electronic warfare, instrumentation and any other general RF amplification needs.



Product Features

- Frequency Range: 2 – 22 GHz
- High Input Power Survivability: 40 dBm
- Noise Figure: 2.0 dB (midband)
- Gain > 15 dB
- IM3: -31 dBc ($P_{IN}/tone = -4$ dBm, $\Delta f = 10$ MHz)
- P1dB > 20 dBm
- Bias: : $V_D = +8$ V, $I_{DQ} = 125$ mA
- Die Dimensions: 2.040 x 1.490 x 0.1 mm

Applications

- Commercial & Military Communications
- Commercial & Military Radar
- Electronic Warfare
- Instrumentation
- LNA, driver, gain block, general amplification

Functional Block Diagram

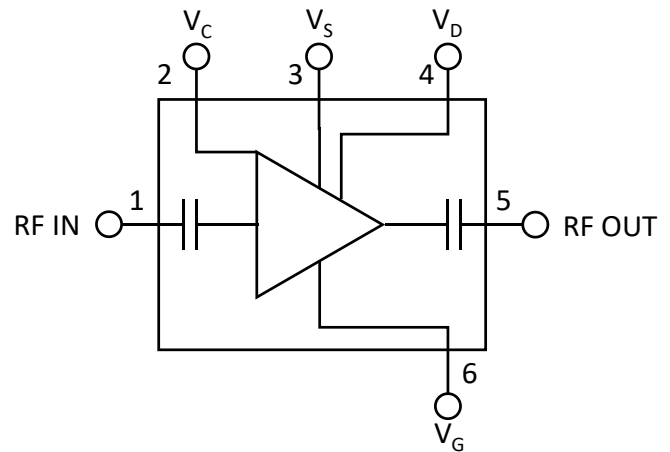

Ordering Information

Part No.	Description
TGA2227	2 – 22 GHz GaN LNA
TGA2227EVB02	TGA2227 Evaluation Board

Recommended Operating Conditions

Parameter	Value / Range
Drain Voltage (V_D), Low P_{BISS} Bias	+8.0 V
Drain Voltage (V_D), Power Bias	+15.0 V
Quiescent Drain Current (I_{DQ})	125 mA
Gate Voltage (V_G)	-3.0 V
Cascode Voltage (V_C), Low P_{BISS} Bias	+2.0 V
Cascode Voltage (V_C), Power Bias	+4.0 V
Operating Temperature Range	-40 to +85 °C

Electrical Specifications

Parameter	Min	Typ	Max	Units
Frequency Range	2	–	22	GHz
Small Signal Gain	–	16.0	–	dB
Noise Figure	–	2.5	–	dB
Input Return Loss	–	10	–	dB
Output Return Loss	–	12	–	dB
P_{SAT}	–	23.4	–	dBm
P_{1dB}	–	20.3	–	dBm
IM3 ($P_{IN}/tone = -4$ dBm, $\Delta f = 10$ MHz)	–	-31	–	dBc
S21 Temperature Coefficient	–	-0.022	–	dB/°C
NF Temperature Coefficient	–	0.012	–	dB/°C
Recommended Operating Voltage	5	8	20	V

Test conditions, unless otherwise noted: $T_{BASE} = 25$ °C, $V_D = +8$ V, $V_C = +2$ V

Electrical Specifications

Parameter	Min	Typ	Max	Units
Frequency Range	2	–	22	GHz
Small Signal Gain	–	15.9	–	dB
Noise Figure	–	2.5	–	dB
Input Return Loss	–	10	–	dB
Output Return Loss	–	12	–	dB
P_{SAT}	–	25.8	–	dBm
P_{1dB}	–	22.6	–	dBm
IM3 ($P_{IN}/tone = -4$ dBm, $\Delta f = 10$ MHz)	–	-35	–	dBc
S21 Temperature Coefficient	–	-0.024	–	dB/°C
NF Temperature Coefficient	–	0.011	–	dB/°C
Recommended Operating Voltage	5	15	20	V

Test conditions, unless otherwise noted: $T_{BASE} = 25$ °C, $V_D = +15$ V, $V_C = +4$ V

Absolute Maximum Ratings

Parameter	Value / Range
Drain Voltage (V_D)	+29.5 V
Cascode Voltage (V_C)	$V_C < V_D$ and $V_C < +9$ V
Drain Current (I_D)	300 mA
Gate Voltage (V_G)	-5 to 0 V
Gate Current (I_G)	See graph on page
RF Input Power (25 °C, 50 Ω)	40 dBm
Channel Temperature (T_{CH})	275 °C
Mounting Temperature (30 seconds maximum)	320 °C
Storage Temperature	-55 to +150 °C

Notes:

1. Maximum V_C is dependent on the V_D used

Thermal and Reliability Information

Parameter	Values	Units	Conditions
Small Signal, Thermal Resistance (θ_{JC}) ^(1,2,3)	3.49	°C/W	$T_{BASE} = +85$ °C, $V_D = +8$ V, $V_C = +2.0$ V $V_G = -2.4$ V, $I_{D_DRIVE} = 125$ mA $P_{IN} = -10$ dBm, $P_{OUT} = +6$ dBm, $P_{DISS} = 1.00$ W
Channel Temperature (T_{CH})	88.49	°C	
Small Signal, Thermal Resistance (θ_{JC}) ^(1,2,3)	4.96	°C/W	$T_{BASE} = 85$ °C, $V_D = +15$ V, $V_C = +4.0$ V $V_G = -2.4$ V, $I_{D_DRIVE} = 125$ mA $P_{IN} = -10$ dBm, $P_{OUT} = +6$ dBm, $P_{DISS} = 1.88$ W
Channel Temperature (T_{CH})	94.32	°C	
Under Drive, Thermal Resistance (θ_{JC}) ^(1,2,3)	5.42	°C/W	$T_{BASE} = 85$ °C, $V_D = +15$ V, $V_C = +4.0$ V $V_G = -2.4$ V, $I_{D_DRIVE} = 231$ mA $P_{IN} = +16$ dBm, $P_{OUT} = +28.3$ dBm, $P_{DISS} = 2.83$ W
Channel Temperature (T_{CH})	100.34	°C	

Notes:

1. Thermal resistance is measured to die backside
2. Base or ambient temperature is 85 °C
3. Refer to the following document: [GaN Device Channel Temperature, Thermal Resistance, and Reliability Estimates](#)

Maximum Gate Current

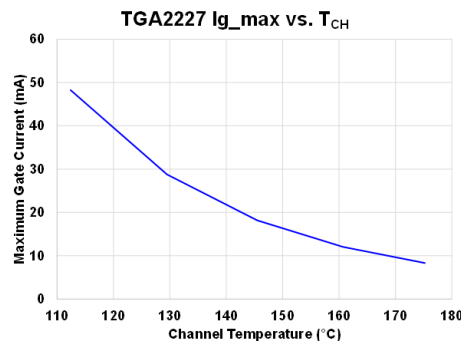

Performance Plots – Small Signal

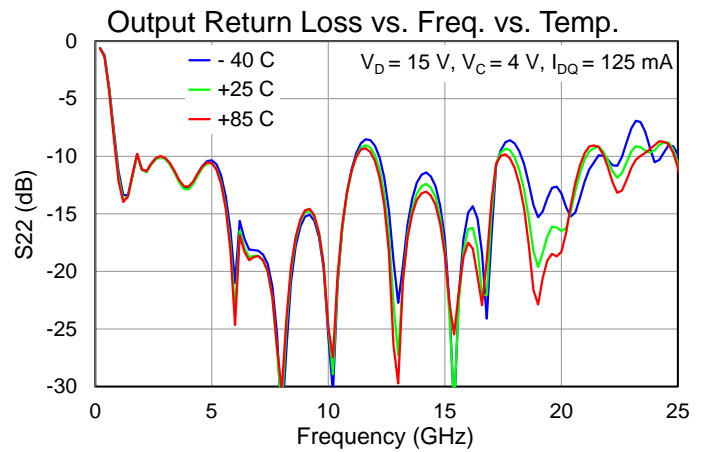
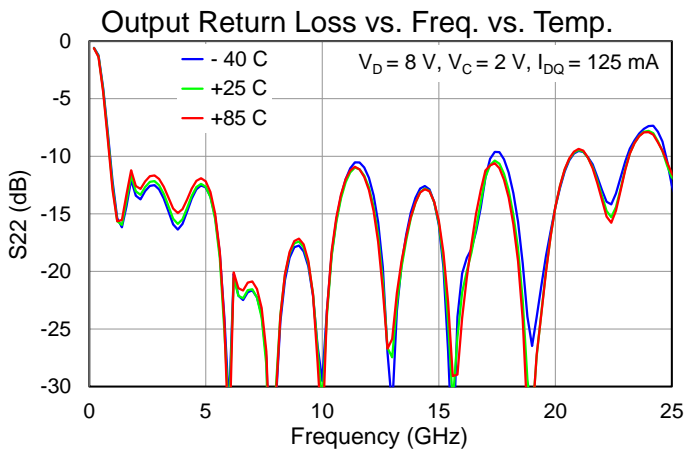
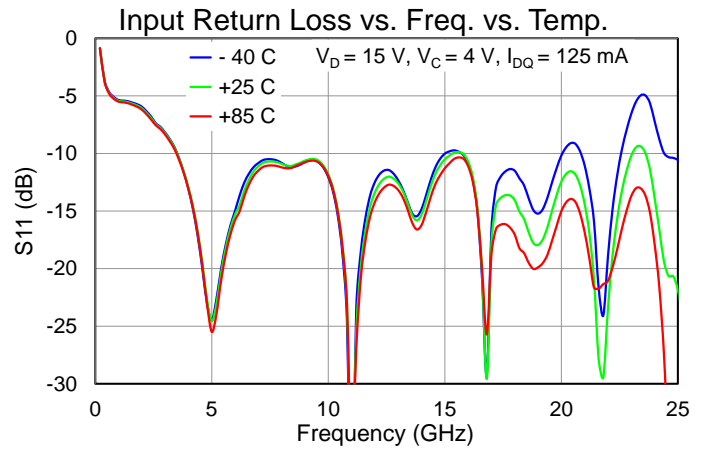
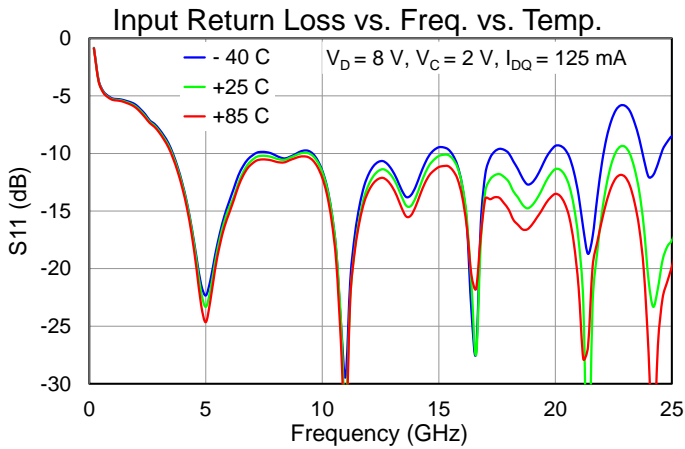
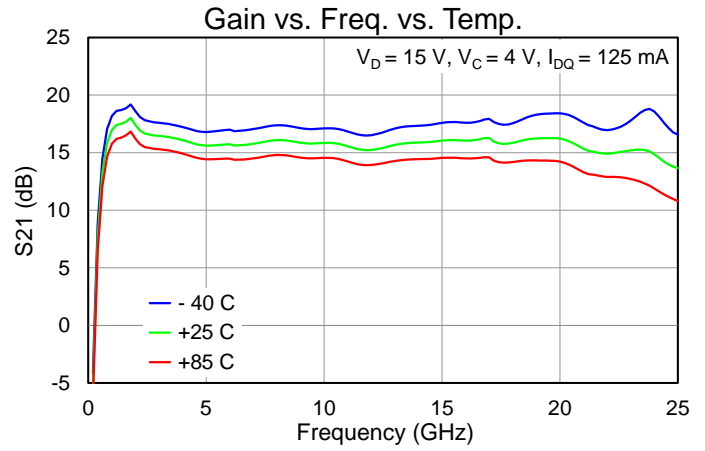
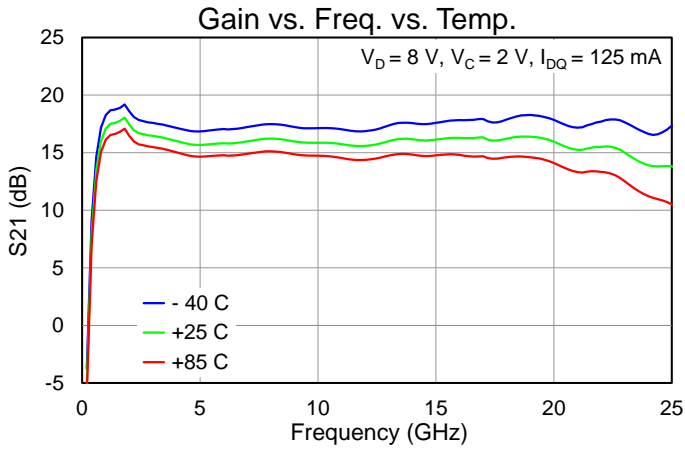

Performance Plots – Small Signal

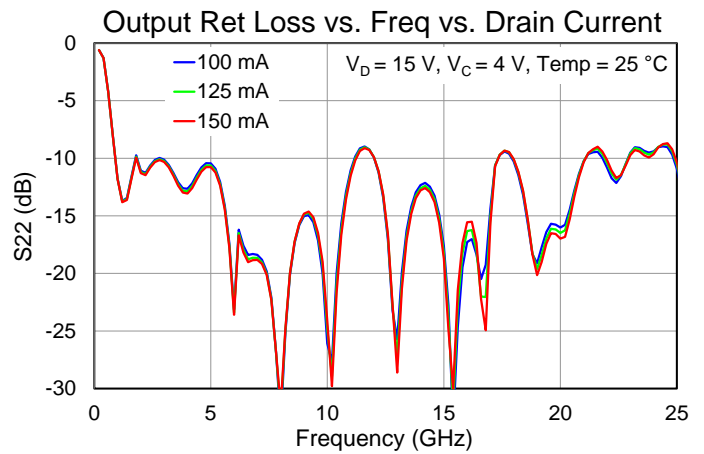
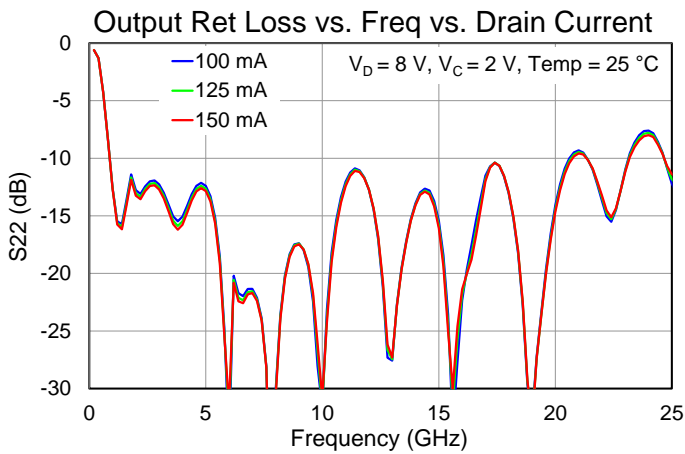
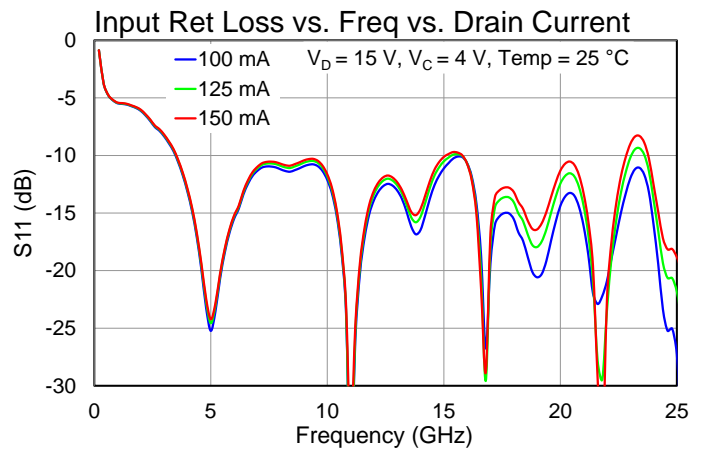
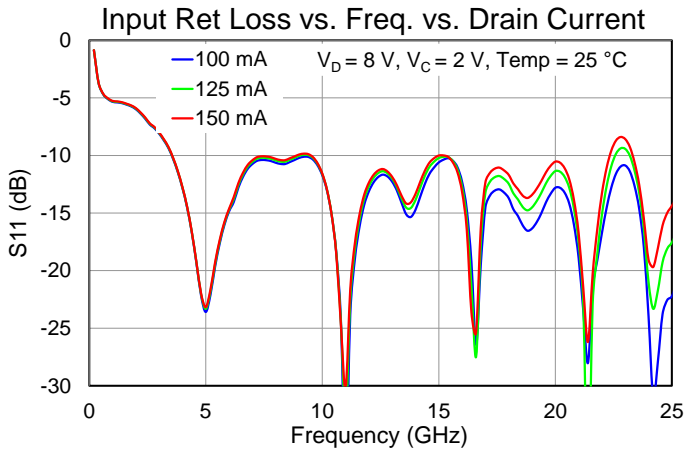
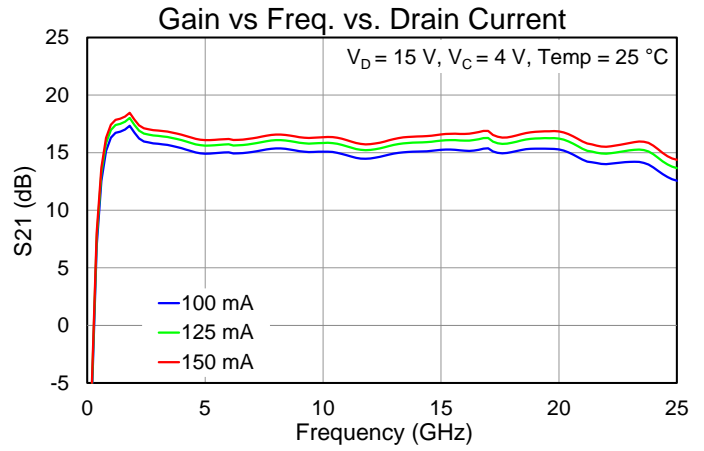
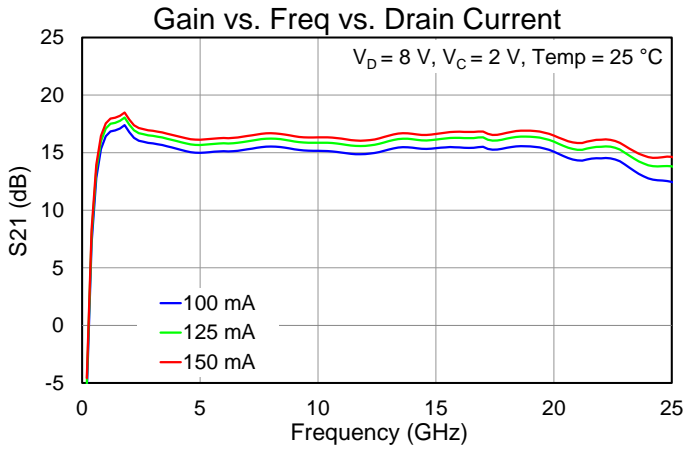

Performance Plots – Noise Figure

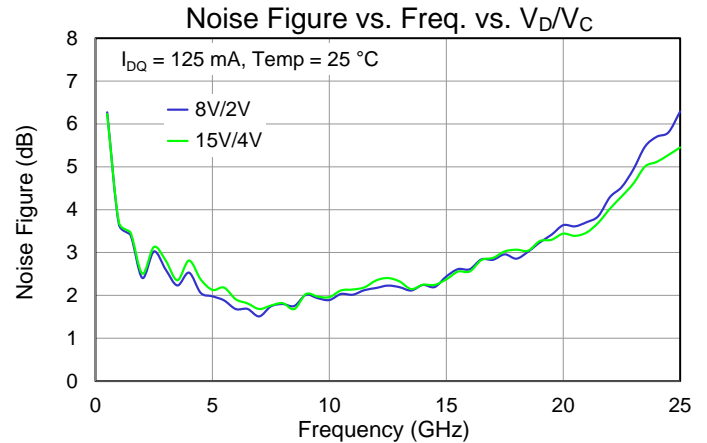
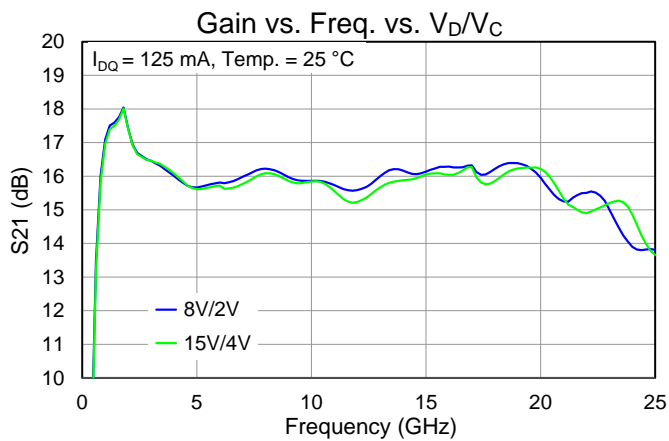
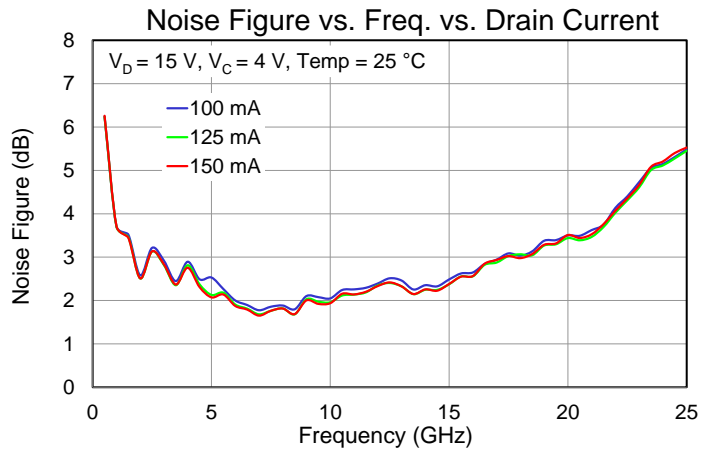
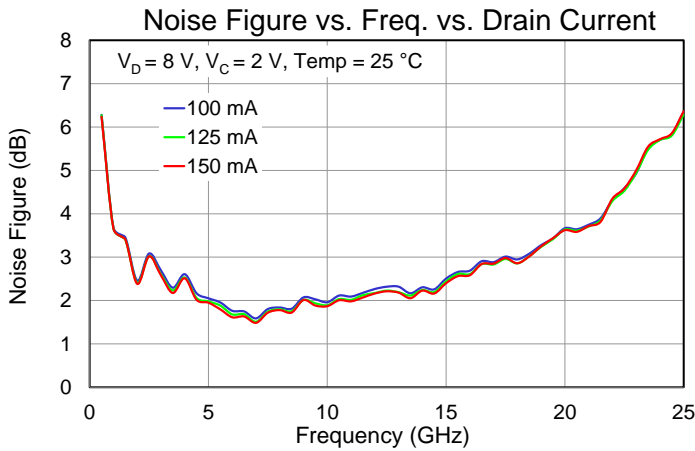
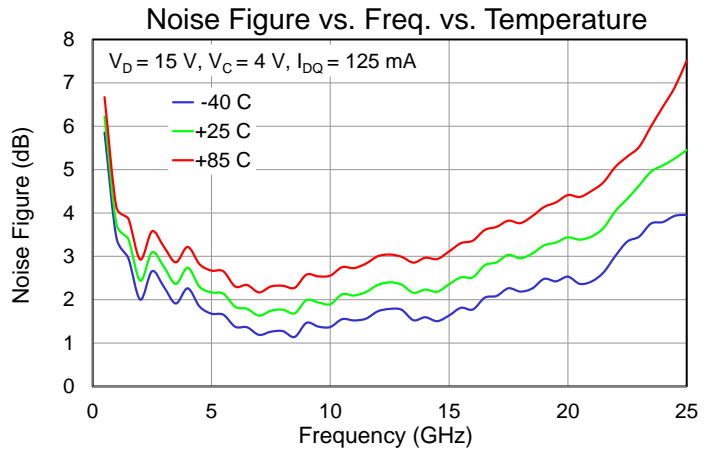
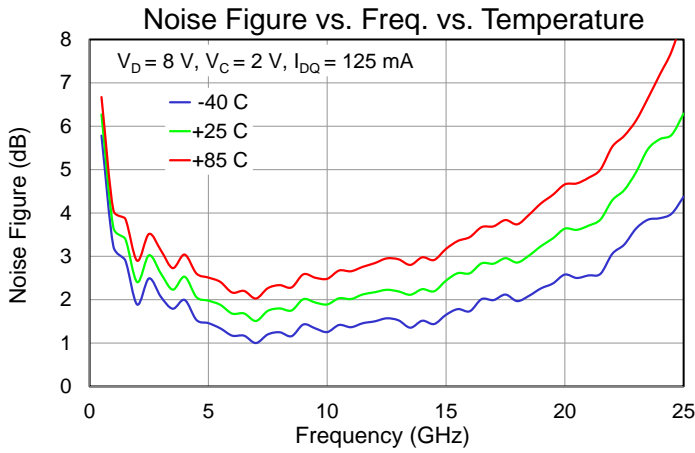

Performance Plots – Large Signal

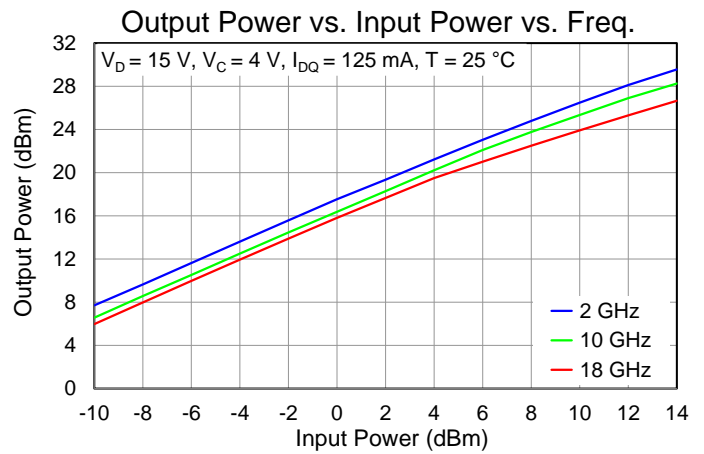
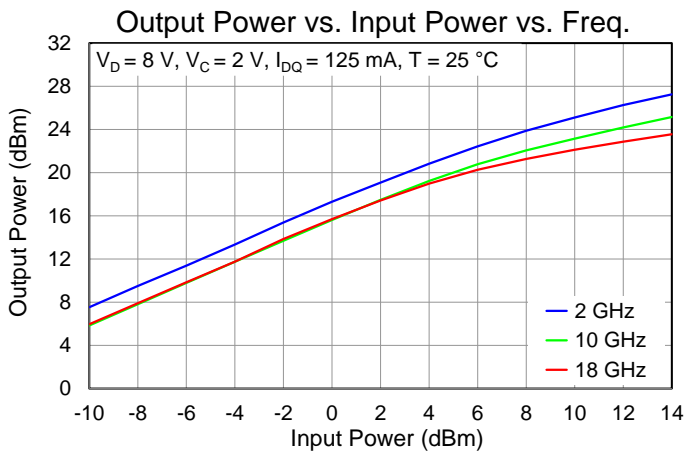
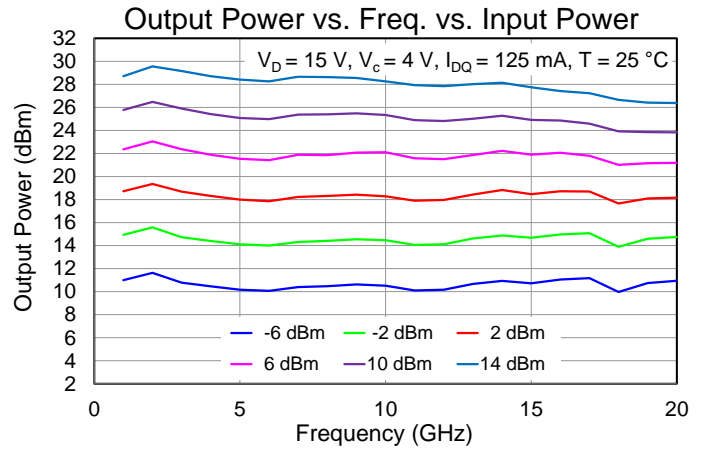
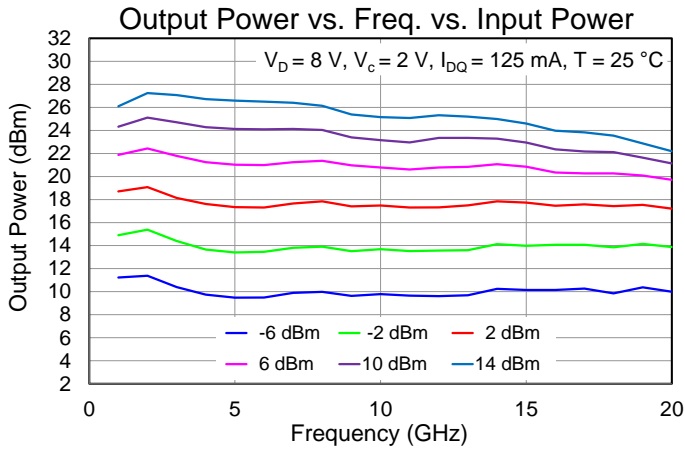
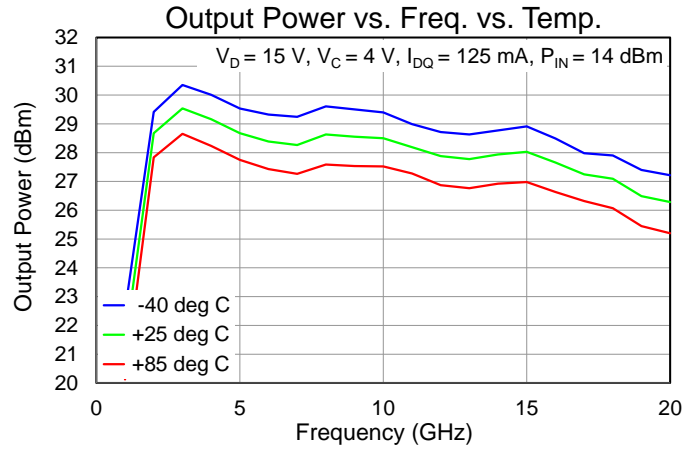
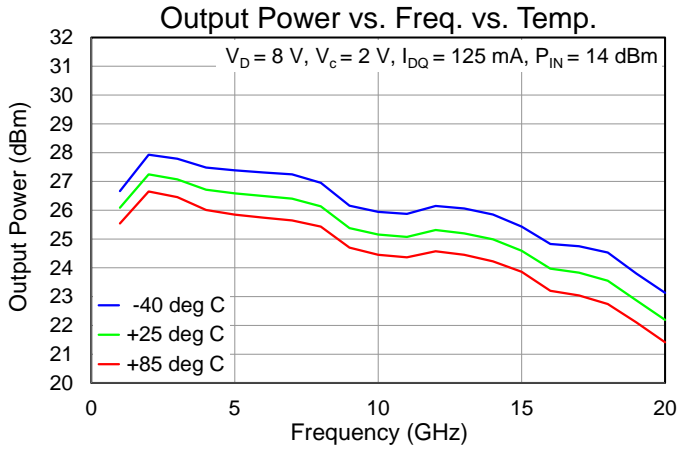

Performance Plots – Large Signal

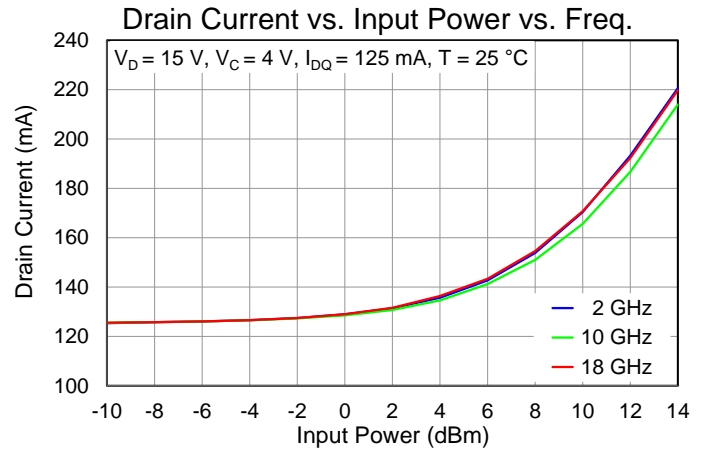
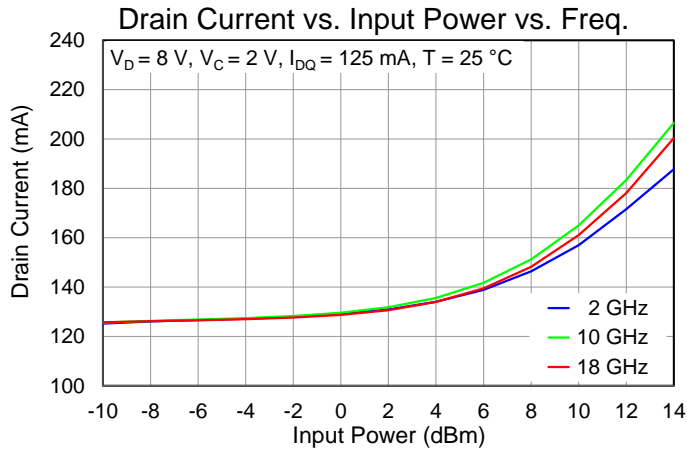
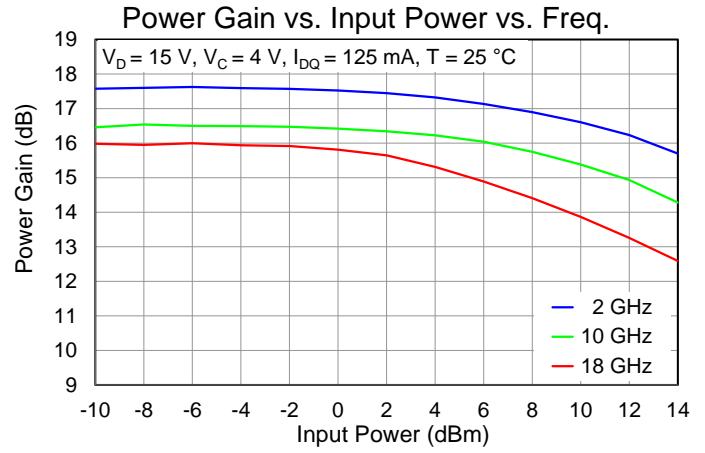
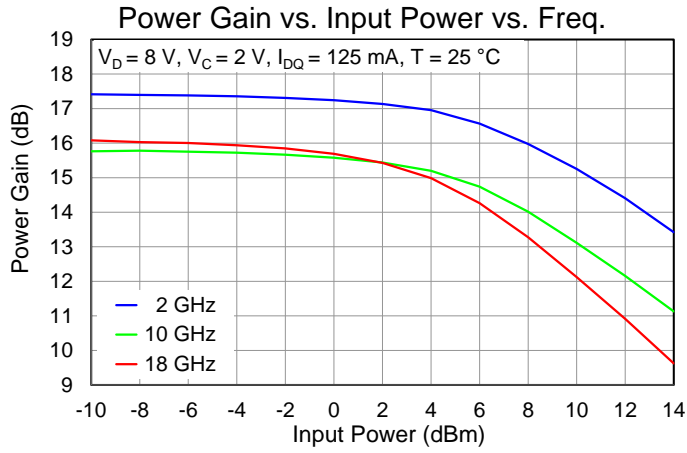

Performance Plots – Linearity

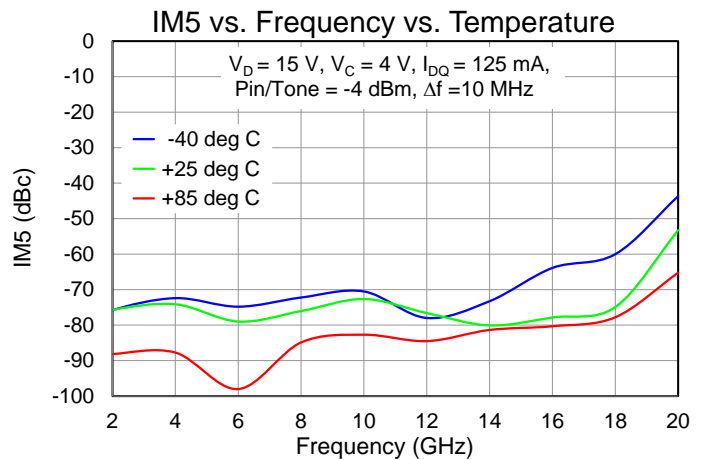
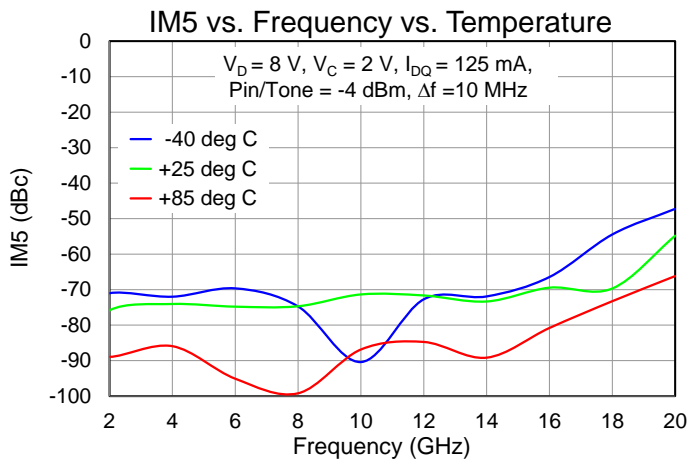
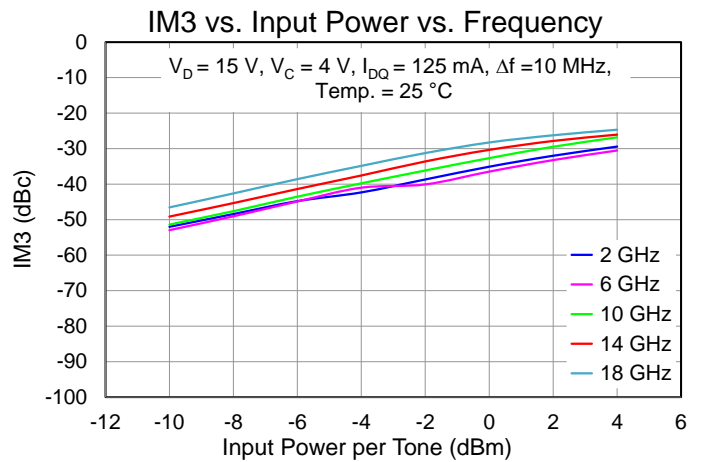
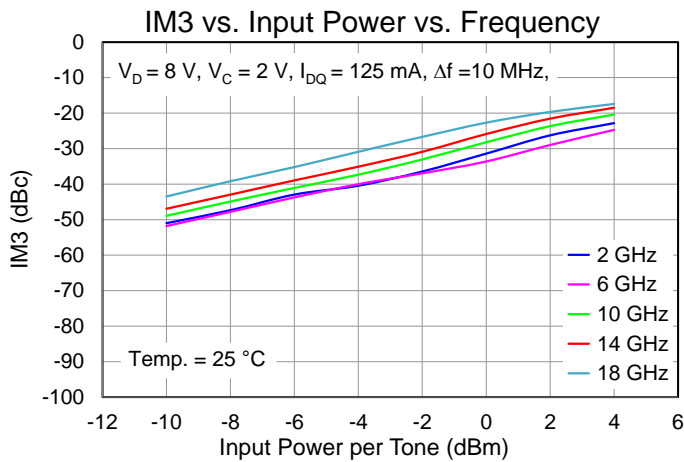
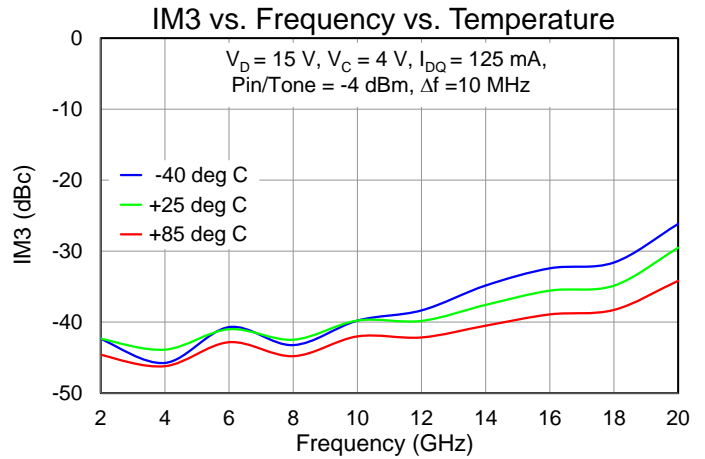
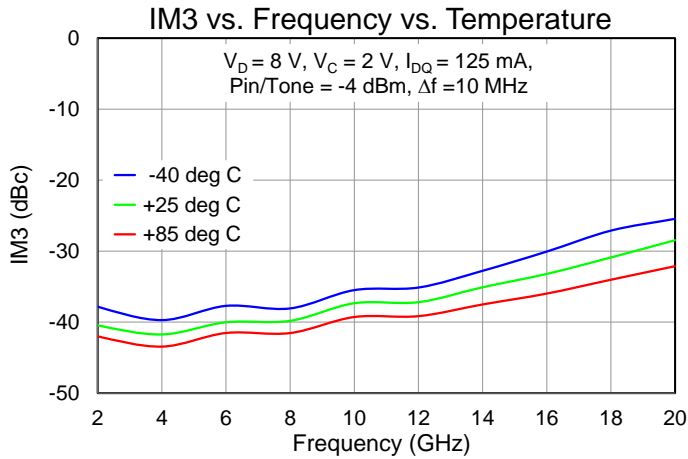

Performance Plots – Linearity

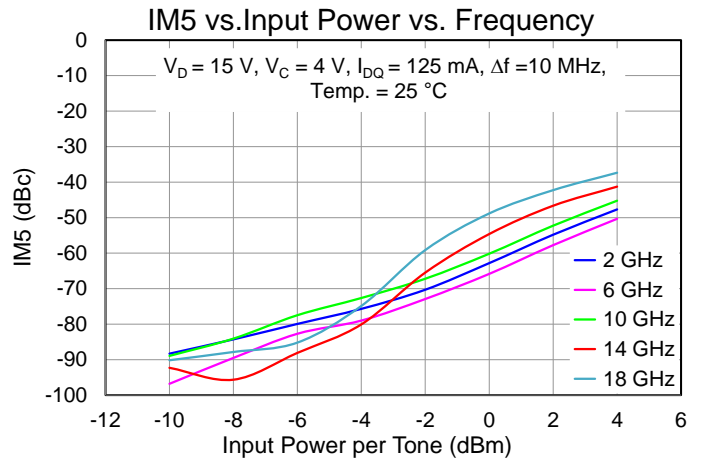
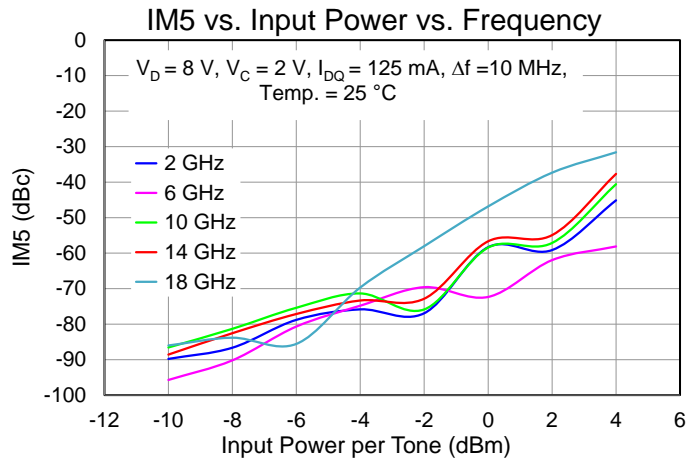

Application Circuit

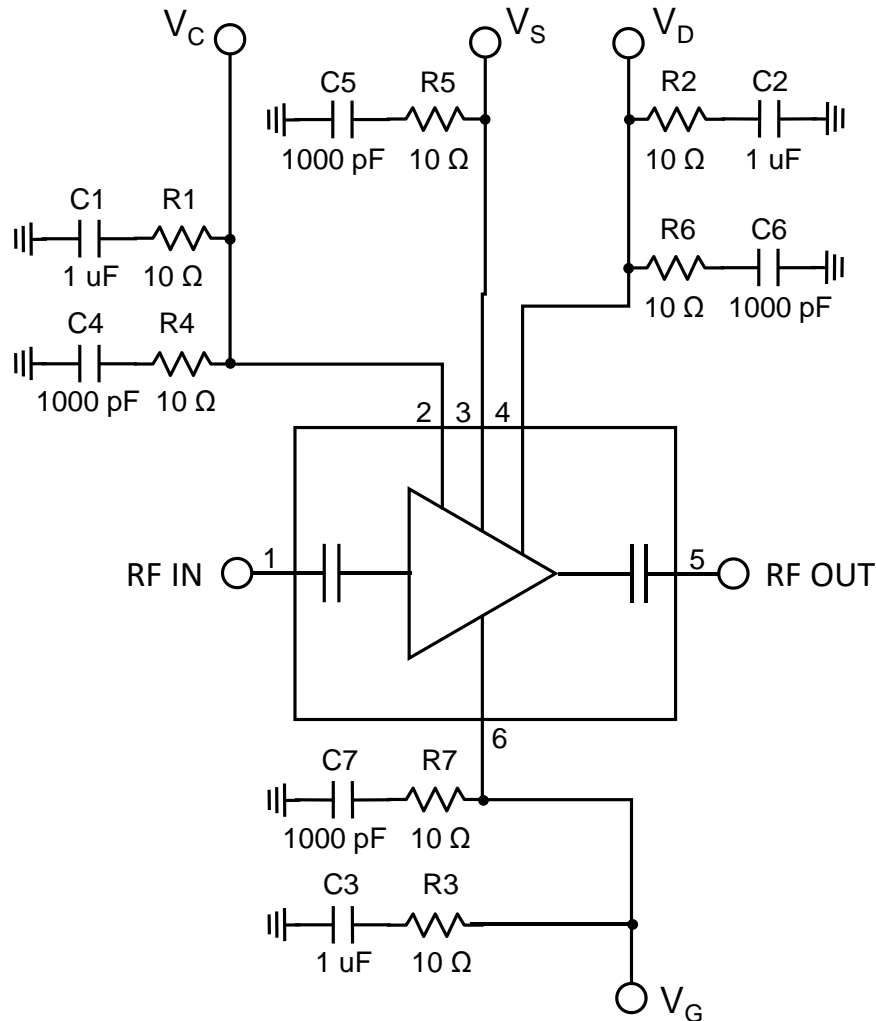

Bias Up Procedure

1. Set $V_G = -5.0\text{ V}$, $V_C = 0.0\text{ V}$, $V_D = 0.0\text{ V}$
2. Adjust V_D to desired drain voltage
3. Adjust V_C to desired voltage
4. Adjust V_G until $I_{DS} = 125\text{ mA}$
5. Turn on RF signal

Bias Down Procedure

1. Turn off RF signal
2. Adjust V_G to -5.0 V
3. Adjust V_C to 0.0 V
4. Adjust V_D to 0.0 V
5. Adjust V_G to 0.0 V

EVB Part Number or Ref. Design Name

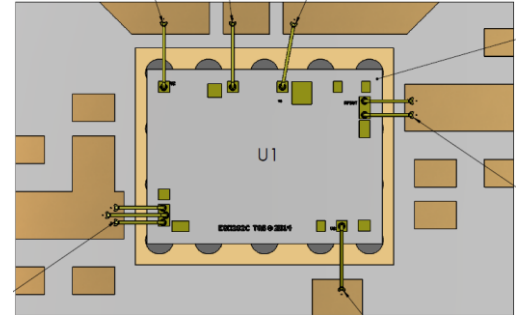
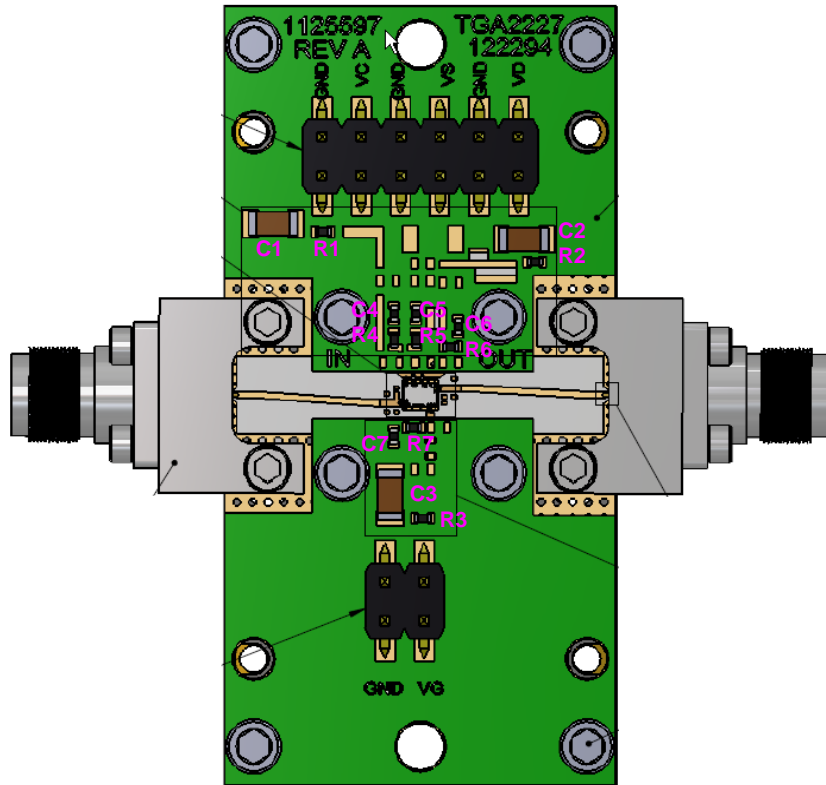

MMIC mounting/wire bonding detail

RF Layer is 0.008" thick Rogers Corp. RO4003C, $\epsilon_r = 3.38$. Metal layers are 0.5 oz. copper. The microstrip line at the connector interface is optimized for the Southwest Microwave end launch connector 1092-01A-5.

The trace pattern shown has been developed and tested for optimized assembly at TriQuint Semiconductor. The PCB land pattern has been developed to accommodate lead tolerances. Since processes vary from company to company, careful process development is recommended.

Note: Conductive epoxy is used for attaching the die to the EVB PCB.

Bill of Materials

Reference Des.	Value	Description	Manuf.	Part Number
C1 – C3	1 uF, +50 V, 5 %	CAP X5R 1206	Various	–
C4 – C7	1000 pF, +50 V, 10 %	CAP X7R 0402	Various	–
R1 – R2, R4 – R7	10 Ohm, 5 %	RES 0402, SMD	Various	–
R3	Not used	–	–	–

Mechanical Drawing and Bond Pad Description

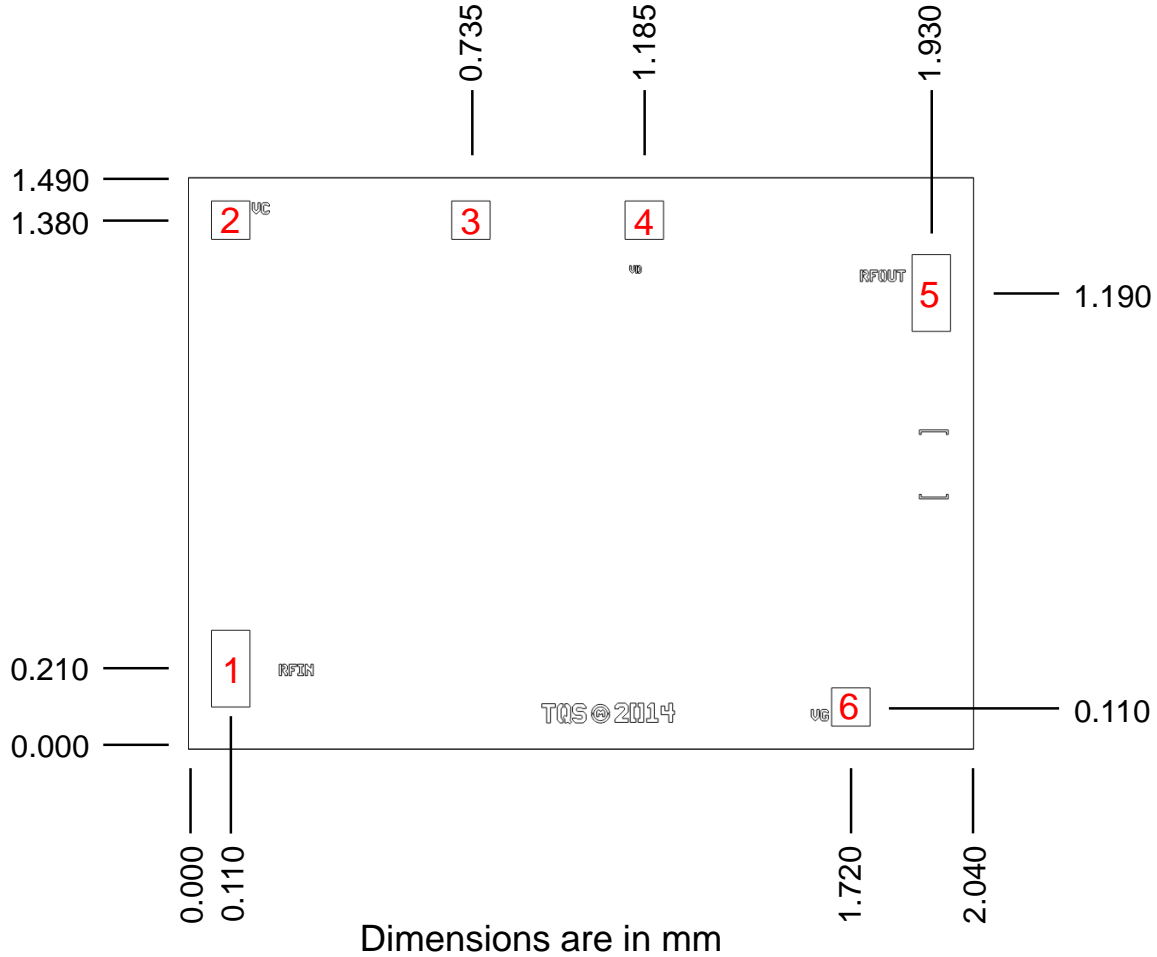

Pad Number	Symbol	Description	Pad Size (um x um)
1	RF Input	RF input pad, DC blocked	100 x 200
2	V _c	Cascode voltage	100 x 100
3	V _s	Drain voltage monitor	100 x 100
4	V _d	Drain voltage	100 x 100
5	RF Output	RF output pad, DC blocked	100 x 200
6	V _g	Gate voltage	100 x 100

Assembly Notes

Component placement and adhesive attachment assembly notes:

- Vacuum pencils and/or vacuum collets are the preferred method of pick up.
- Air bridges must be avoided during placement.
- The force impact is critical during auto placement.
- Organic attachment (i.e. epoxy) can be used in low-power applications and for die attach to soft substrates.
- Curing should be done in a convection oven; proper exhaust is a safety concern.

Reflow process assembly notes:

- Use AuSn (80/20) solder and limit exposure to temperatures above 300 °C to 3 – 4 minutes, maximum.
- An alloy station or conveyor furnace with reducing atmosphere should be used.
- Do not use any kind of flux.
- Coefficient of thermal expansion matching is critical for long-term reliability.
- Devices must be stored in a dry nitrogen atmosphere.

Interconnect process assembly notes:

- Thermosonic ball bonding is the preferred interconnect technique.
- Force, time, and ultrasonics are critical parameters.
- Aluminum wire should not be used.
- Devices with small pad sizes should be bonded with 0.0007-inch wire.

Handling Precautions

Parameter	Rating	Standard
ESD – Human Body Model (HBM)	TBD	JEDEC Standard JESD22 A114



Caution!
ESD-Sensitive Device

RoHS Compliance

This product is compliant with the 2011/65/EU RoHS directive (Restrictions on the Use of Certain Hazardous Substances in Electrical and Electronic Equipment), as amended by Directive 2015/863/EU. This product also has the following attributes:

- Lead Free
- Halogen Free (Chlorine, Bromine)
- Antimony Free
- TBBP-A (C₁₅H₁₂Br₄O₂) Free
- PFOS Free
- SVHC Free

Contact Information

For the latest specifications, additional product information, worldwide sales and distribution locations:

Tel: 1-844-890-8163

Web: www.qorvo.com

Email: customer.support@qorvo.com

For technical questions and application information:

Email: appsupport@qorvo.com

Important Notice

The information contained herein is believed to be reliable; however, Qorvo makes no warranties regarding the information contained herein and assumes no responsibility or liability whatsoever for the use of the information contained herein. All information contained herein is subject to change without notice. Customers should obtain and verify the latest relevant information before placing orders for Qorvo products. The information contained herein or any use of such information does not grant, explicitly or implicitly, to any party any patent rights, licenses, or any other intellectual property rights, whether with regard to such information itself or anything described by such information. **THIS INFORMATION DOES NOT CONSTITUTE A WARRANTY WITH RESPECT TO THE PRODUCTS DESCRIBED HEREIN, AND QORVO HEREBY DISCLAIMS ANY AND ALL WARRANTIES WITH RESPECT TO SUCH PRODUCTS WHETHER EXPRESS OR IMPLIED BY LAW, COURSE OF DEALING, COURSE OF PERFORMANCE, USAGE OF TRADE OR OTHERWISE, INCLUDING THE IMPLIED WARRANTIES OF MERCHANTABILITY AND FITNESS FOR A PARTICULAR PURPOSE.**

Without limiting the generality of the foregoing, Qorvo products are not warranted or authorized for use as critical components in medical, life-saving, or life-sustaining applications, or other applications where a failure would reasonably be expected to cause severe personal injury or death.

© 2020 Qorvo US, Inc. All rights reserved. This document is subject to copyright laws in various jurisdictions worldwide and may not be reproduced or distributed, in whole or in part, without the express written consent of Qorvo US, Inc.

Looking for pricing, stock, or lifecycle information?

Click below to explore more details on WIN SOURCE:

 [View TGA2227 on WIN SOURCE](#)

 [Qorvo US Inc. Information](#)

Optimize Your Supply Chain with WIN SOURCE Solutions

-  Global Sourcing Solution
-  Obsolete Management
-  Cost Control Management
-  Shortage Management
-  Alternative Solution
-  Excess Inventory Management