

Multi-stage AC/DC EMC/RFI Filter with Excellent Attenuation Performance



- Rated currents from 1 to 30 A
- Two-stage filter
- Very high differential and common-mode attenuation
- Optional low power loss version (R type)
- Optional medical versions (B type)
- Optional safety versions (A type)
- Optional enhanced performance versions
- Optional overvoltage protection (Z type)



Performance indicators

Attenuation performance



Rated current [A]

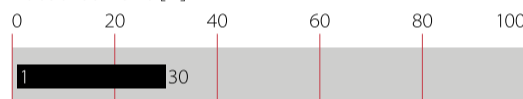

Approvals & Compliances



Features and Benefits

- FN 2090 two-stage filters are designed for easy and fast chassis mounting.
- FN 2090 R versions without discharge capacitors, reducing standby current
- FN 2090 B versions without capacitors to earth comply to 1MOP for ME (medical equipment) acc. IEC 60601-1
- FN 2090 A versions with low capacitance to earth for safety critical applications with a requirement for low leakage currents.
- FN 2090 filters offers an optimized filter range for enhanced performance AC and DC applications, in same compact size (KK, LL, NN types)
- All filters provide an exceptional conducted attenuation performance, based on chokes with high permeable core material.
- FN 2090 two-stage filters are designed for noisy applications requiring excellent filter performance.
- The higher inductivity offers increased attenuation performance with the same form factor as FN 2060 and FN 2080 series.
- All FN 2090 filters can be delivered with optional surge pulse protection (Z type).
- FN 2090 filters are also available as singlestage filters (FN 2030 series).
- Various terminal options allow you to select the desired connection style.

Technical Specifications

Maximum continuous operating voltage	250 VAC, 50/60 Hz 250 VDC
Nominal operating voltage	230 VAC
Rated currents	1 to 30 A @ 40°C
Operating frequency	DC to 400 Hz
High potential test voltage	P → N 1100 VDC for 2 sec P → PE 2000 VAC for 2 sec (equiv. cap <88 nF) P → PE 2550 VDC for 2 sec (equiv. cap >88 nF) P → PE 2500 VAC for 2 sec (B types)
Overvoltage category	II acc. IEC 60664-1
Pollution degree	2 acc. IEC 60664-1
Surge pulse protection (Z type)	Helps compliance to IEC61000-4-5 (Differential Mode only)
Temperature range (operation and storage)	-25°C to +100°C (25/100/21)**
Altitude	2000m (above derating applies)**
Flammability corresponding to	Laces for -07 version: UL 94 VW-1 Terminal plastic for -06/-08 version: UL 94 V-0 Grommet for -07 version: UL 94 V-0
Certified to	UL 1283, CSA 22.2 No. 8 1986, IEC/EN 60939 (applies to AC and DC applications)
MTBF (Mil-HB-217F)	≤10 A: >1,300,000 h @ 40°C/230 V ≥12 A: >1,100,000 h @ 40°C/230 V

* maximum RMS operating voltage at rated frequency or the maximum DC operating voltage
 ** for dedicated requests exceeding this specification (e.g. -40 °C or higher altitude) please contact your local Schaffner Sales office

Typical Applications

- Electrical and electronic equipment
- Consumer goods
- Household equipment
- Building automation
- Industrial applications
- Machinery
- Medical equipment
- Electronic data processing equipment
- Office automation and datacom equipment
- Various noisy applications requiring high filter performance

Typical electrical schematic

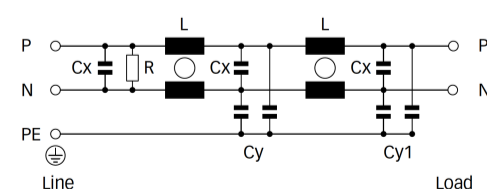

Filter Selection Table

Filter*	Buy	Rated current @ 40°C (25°C) [A]	Leakage current** @ 250V AC/50 Hz (@ 120V AC/60 Hz) [mA]	Power Loss @ 25°C/DC [W]	Inductance*** L [mH]	Capacitance***			Resistance*** R [kΩ]	Input/Output connections			Weight [g]
						Cx [μF]	Cy1 [nF]	Cy2 [nF]					
FN2090-1-..		1 (1.1)	0.45 (0.26)	1.8	20	0.22	2.2	1.0	680	-06	-07		73
FN2090-3-..		3 (3.4)	0.45 (0.26)	3.7	14	0.33	2.2	1.0	470	-06	-07		158
FN2090-4-..		4 (4.5)	0.45 (0.26)	6.4	14	0.33	2.2	1.0	470	-06	-07		176
FN2090-6-..		6 (6.7)	0.61 (0.35)	7.1	8	0.47	3.3	1.0	330	-06	-07	-08	191
FN2090-8-..		8 (8.9)	0.61 (0.35)	7.7	8	0.47	3.3	1.0	330	-06	-07		330
FN2090-10-..		10 (11.2)	0.61 (0.35)	8.4	8	0.47	3.3	1.0	330	-06	-07	-08	369
FN2090-12-..		12 (13.4)	0.93 (0.54)	12.1	4	1	10	1.0	220	-06	-07	-08	391
FN2090-16-..		16 (17.9)	0.93 (0.54)	10.7	4	1	10	1.0	220	-06	-07		425
FN2090-20-..		20 (22.4)	0.93 (0.54)	8.2	2.7	1	10	1.0	220	-06		-08	530
FN2090-30-08		30 (33.5)	0.93 (0.54)	10.1	1.5	1	10	1.0	220			-08	548
Reduced Power loss ****													
FN2090R-4-06		4 (4.5)	0.45 (0.26)	6.4	14	0.33	2.2	1.0		-06			172
FN2090R-6-06		6 (6.7)	0.61 (0.35)	7.1	8	0.47	3.3	1.0		-06			326
FN2090R-10-06		10 (11.2)	0.61 (0.35)	8.4	8	0.47	3.3	1.0		-06			365
FN2090R-16-06		16 (17.9)	0.93 (0.54)	10.7	4	1	10	1.0		-06			421
FN2090R-20-06		20 (22.4)	0.93 (0.54)	8.2	2.7	1	10	1.0		-06			526
FN2090R-30-08		30 (33.5)	0.93 (0.54)	10.1	1.5	1	10	1.0				-08	544
Safety (0.07mA IIC)													
FN2090A-1-..		1 (1.1)	0.13 (0.07)	1.8	20	0.22	0.47	0.47	680	-06	-07		73
FN2090A-3-..		3 (3.4)	0.13 (0.07)	3.7	14	0.33	0.47	0.47	470	-06	-07		158
FN2090A-4-..		4 (4.5)	0.13 (0.07)	6.4	14	0.33	0.47	0.47	470	-06	-07		176
FN2090A-6-..		6 (6.7)	0.13 (0.07)	7.1	8	0.47	0.47	0.47	330	-06	-07	-08	191
FN2090A-8-..		8 (8.9)	0.13 (0.07)	7.7	8	0.47	0.47	0.47	330	-06	-07		330
FN2090A-10-..		10 (11.2)	0.13 (0.07)	8.4	8	0.47	0.47	0.47	330	-06	-07	-08	369
FN2090A-12-..		12 (13.4)	0.13 (0.07)	12.1	4	1	0.47	0.47	220	-06	-07	-08	391
FN2090A-16-..		16 (17.9)	0.13 (0.07)	10.7	4	1	0.47	0.47	220	-06	-07		425
FN2090A-20-..		20 (22.4)	0.13 (0.07)	8.2	2.7	1	0.47	0.47	220	-06		-08	530
FN2090A-30-08		30 (33.5)	0.13 (0.07)	10.1	1.5	1	10	10	220			-08	548
Medical (0mA IIC)													
FN2090B-1-..		1 (1.1)	0.00	1.8	20	0.22			680	-06	-07		73
FN2090B-3-..		3 (3.4)	0.00	3.7	14	0.33			470	-06	-07		158
FN2090B-4-..		4 (4.5)	0.00	6.4	14	0.33			470	-06	-07		176
FN2090B-6-..		6 (6.7)	0.00	7.1	8	0.47			330	-06	-07	-08	191
FN2090B-8-..		8 (8.9)	0.00	7.7	8	0.47			330	-06	-07		330
FN2090B-10-..		10 (11.2)	0.00	8.4	8	0.47			330	-06	-07	-08	369
FN2090B-12-..		12 (13.4)	0.00	12.1	4	1			220	-06	-07	-08	391
FN2090B-16-..		16 (17.9)	0.00	10.7	4	1			220	-06	-07		425
FN2090B-20-..		20 (22.4)	0.00	8.2	2.7	1			220	-06		-08	530
FN2090B-30-08		30 (33.5)	0.00	10.1	1.5	1			220			-08	548
Enhanced performance													
FN2090KK-1-06		1 (1.15)	3.46 (1.99)	1.8	20	0.22	22	22	680	-06	-07		95
FN2090NN-3-06		3 (3.4)	15.71 (9.05)	3.7	14	0.33	100	100	470	-06			200
FN2090NN-4-06		4 (4.5)	15.71 (9.05)	6.4	14	0.33	100	100	470	-06			210
FN2090NN-6-06		6 (6.7)	15.71 (9.05)	7.1	8	0.47	100	100	330	-06			220
FN2090NN-8-06		8 (8.9)	15.71 (9.05)	7.7	8	0.47	100	100	330	-06			340
FN2090LL-10-..		10 (11.2)	5.18 (2.98)	8.4	8	0.47	33	33	330	-06		-08	470
FN2090LL-12-..		12 (13.4)	5.18 (2.98)	12.1	4	1	33	33	220	-06		-08	500
FN2090LL-16-06		16 (17.9)	5.18 (2.98)	10.7	4	1	33	33	220	-06			530
FN2090LL-20-..		20 (23)	5.18 (2.98)	8.2	2.7	1	33	33	220	-06		-08	580
FN2090LL-30-08		30 (33.5)	5.18 (2.98)	10.1	1.5	1	33	33	220			-08	600

* To compile a complete part number, please replace the -.. with the required I/O connection style. For surge pulse protection, please add Z (e.g.

FN2090Z-10-06, FN2090BZ-20-08). The different letters code the used Cy values in the filter type (A = 0.47nF; K = 22nF; L = 33nF; N = 100nF; as the FN2090 is a dual stage filter each letter stands for one stage of Cy)

** Maximum leakage under usual AC operating conditions (acc. IEC 60939-3). Note: if the neutral line is interrupted, worst case leakage could reach twice this level. Leakage current for DC application is 0mA

*** Tolerances apply: Inductance: -30/+50%, Capacitance: ±20%, Resistance: ±10%

**** Reduced power loss in operation due to removed discharge resistors on capacitors

Typical Filter Attenuation

Per CISPR 17: symmetrical 50 Ω/50 Ω -> Differential Mode (DM); asymmetrical 50 Ω/50 Ω -> Common Mode (CM)

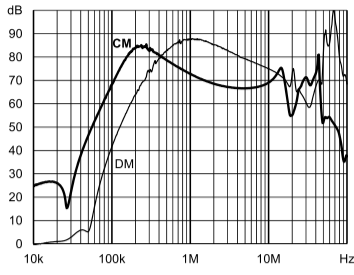

1 A: Standard type

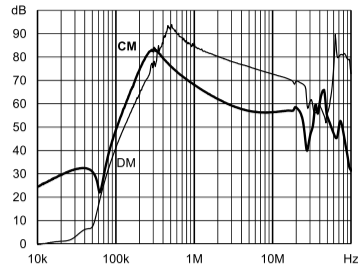

A type

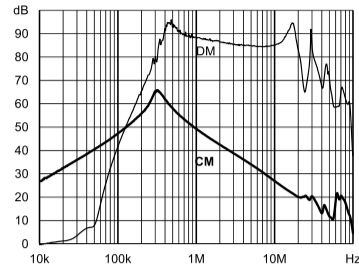

B type

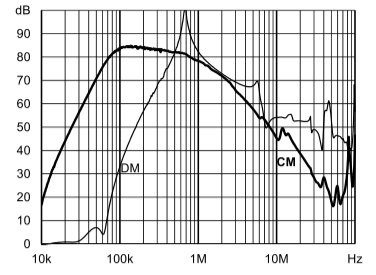

Enhanced performance

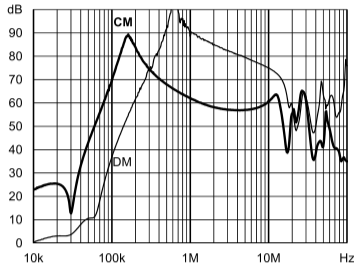

3 A: Standard type

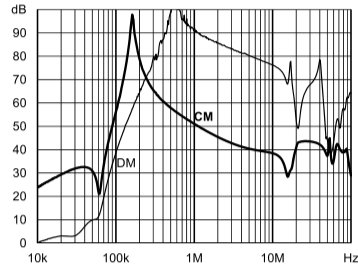

A type

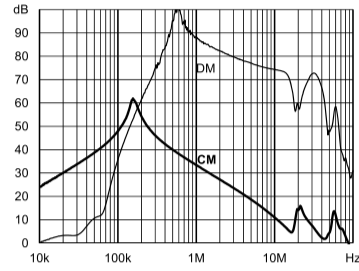

B type

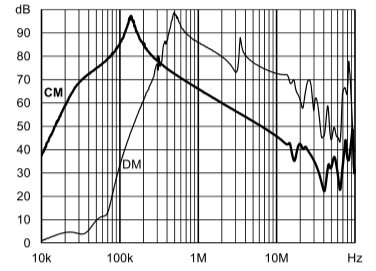

Enhanced performance

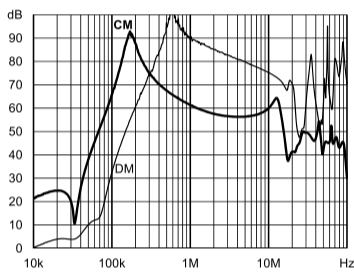

4 A: Standard type

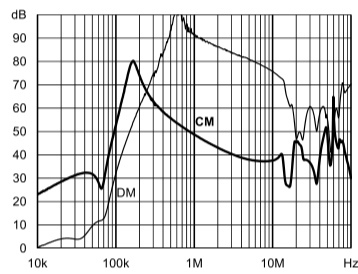

A type

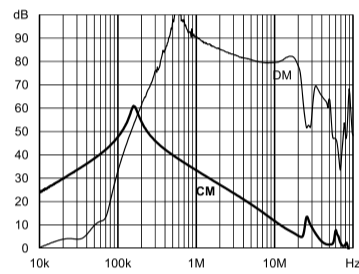

B type

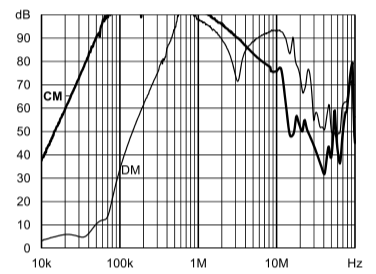

Enhanced performance

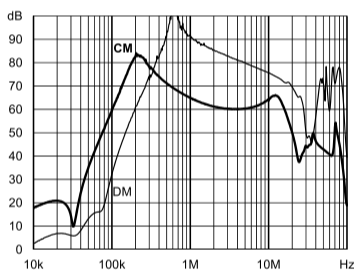

6 A: Standard type

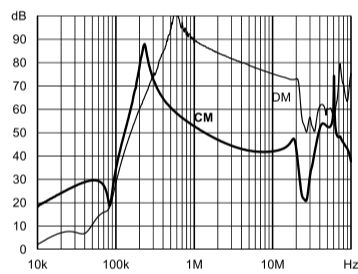

A type

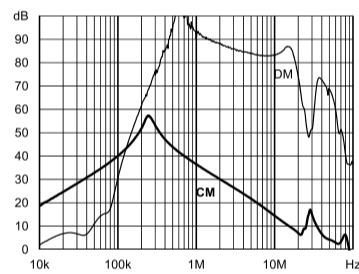

B type

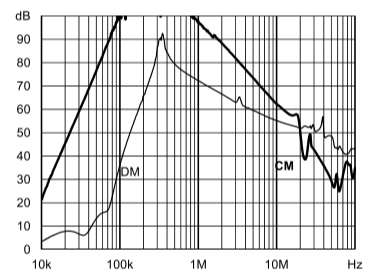

Enhanced performance

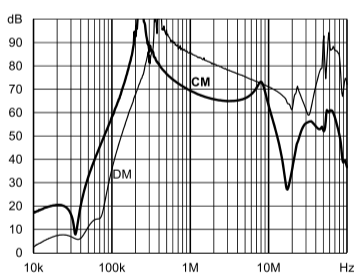

8 A: Standard type

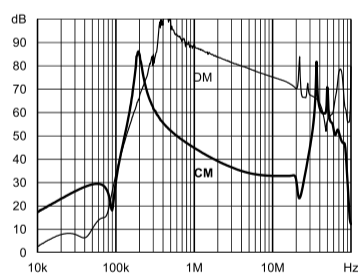

A type

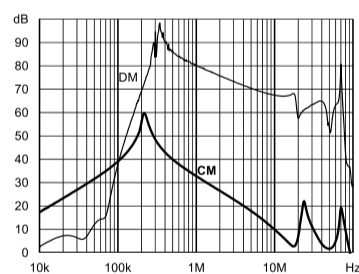

B type

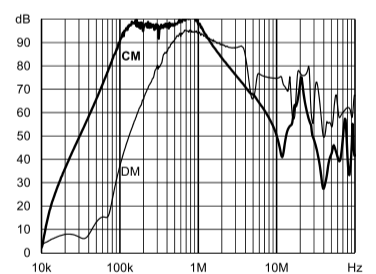

Enhanced performance

Product Selector		
<p>FN 2090 xy-xx-yy</p>	06	Faston 6.3 × 0.8 mm (spade/soldering)
	07	Wire leads
	08	Studs (M4 screws)
	1 to 30	Rated current
	Blank	Standard version
	Z	With surge protection
	Blank	Standard version
	A	Safety version
	B	Medical version
	KK/LL/NN	High performance version

Mechanical Data

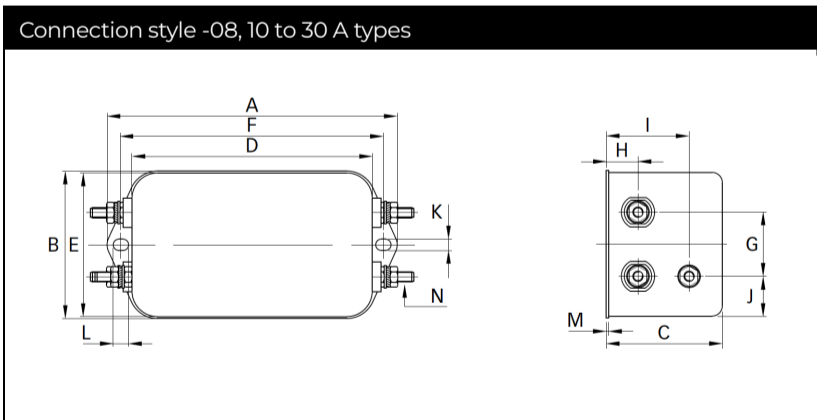
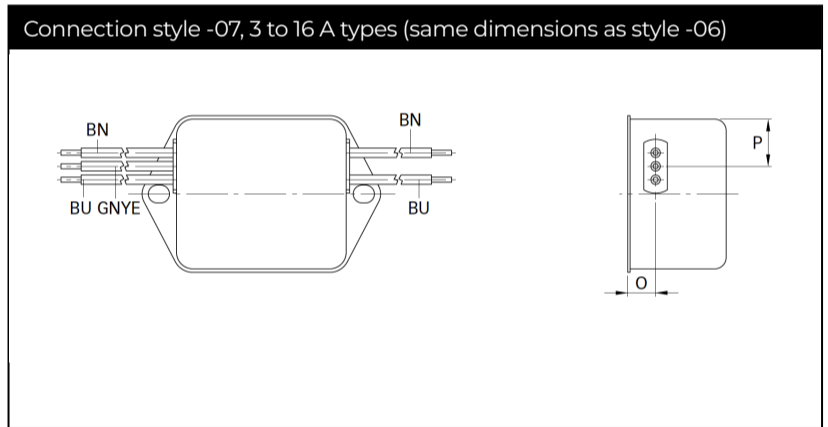
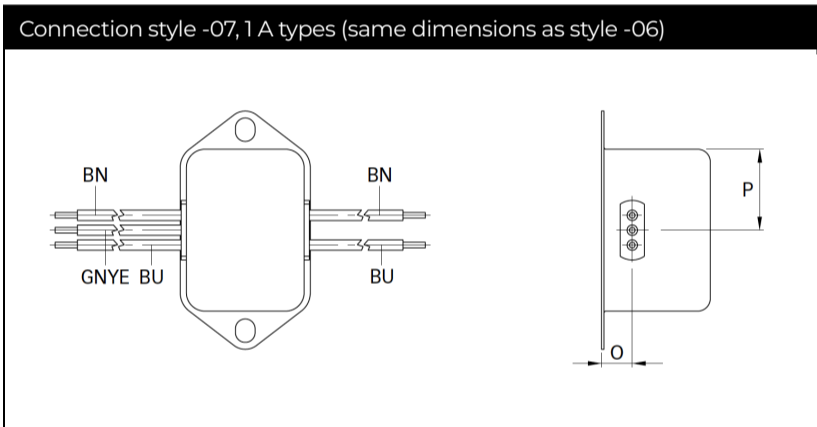
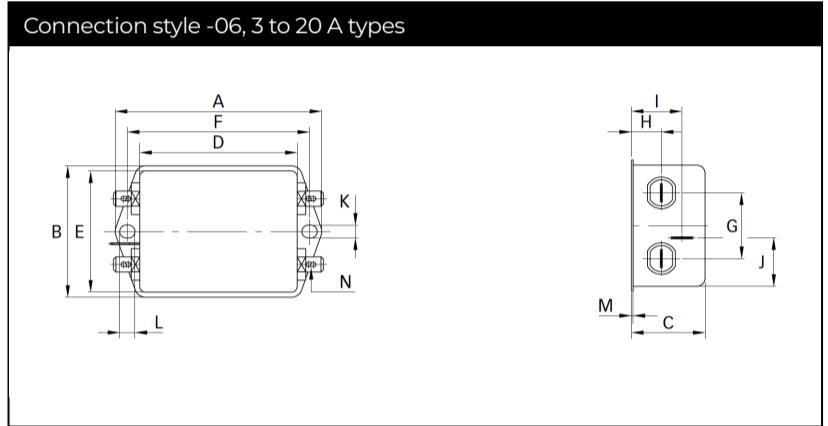
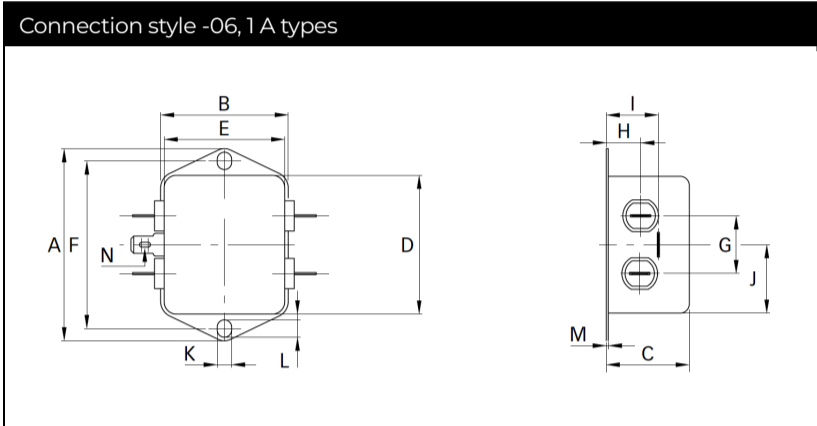

Dimensions

	1 A	3 A	4 A	6 A	8 A	10 A	12 A	16 A	20 A	30 A	Tolerances
A	71	85	85	85	113.5 ±1	113.5 ±1	113.5 ±1	113.5 ±1	113.5 ±1	113.5 ±1	±0.5
B	46.6	54	54	54	57.5 ±1	57.5 ±1	57.5 ±1	57.5 ±1	57.5 ±1	57.5 ±1	±0.5
C	22.3	30.3	30.3	30.3	45.4 ±1	45.4 ±1	45.4 ±1	45.4 ±1	45.4 ±1	45.4 ±1	±0.5
D	50.5	64.8	64.8	64.8	94 ±1	94 ±1	94 ±1	94 ±1	94 ±1	94 ±1	±0.5
E	44.5	49.8	49.8	49.8	56	56	56	56	56	56	±0.5
F	61	75	75	75	103	103	103	103	103	103	±0.3
G	21	27	27	27	25	25	25	25	25	25	±0.2
H	10.8	12.3	12.3	12.3	12.4	12.4	12.4	12.4	12.4	12.4	±0.5
I	16.8	20.8	20.8	20.8	32.4	32.4	32.4	32.4	32.4	32.4	±0.5
J	25.25	19.9	19.9	19.9	15.5	15.5	15.5	15.5	15.5	15.5	±0.5
K	5.3	5.3	5.3	5.3	4.4	4.4	4.4	4.4	4.4	4.4	
L	6.3	6.3	6.3	6.3	6	6	6	6	6	6	
M	0.7	0.7	0.7	0.7	1	1	1	1	1	1	±0.3
Connection style -06											
N	6.3 x 0.8	6.3 x 0.8	6.3 x 0.8	6.3 x 0.8	6.3 x 0.8	6.3 x 0.8	6.3 x 0.8	6.3 x 0.8	6.3 x 0.8	6.3 x 0.8	
Connection style -07											
O	8.3	8.3	8.3	8.3	8.4	8.4	8.4	8.4			±0.5
P	14	14.9	14.9	14.9	18	18	18	18			±0.5
AWG type wire	AWG 20	AWG 20	AWG 20	AWG 18	AWG 18	AWG 18	AWG 16	AWG 16			
Wire length	140	140	140	140	140	140	140	140			+5
Connection style -08											
N						M4	M4	M4	M4	M4	
Recommended torque (Nm)						1.2 - 1.3	1.2 - 1.3	1.2 - 1.3	1.2 - 1.3	1.2 - 1.3	
Earth terminal						1.5 - 1.7	1.5 - 1.7	1.5 - 1.7	1.5 - 1.7	1.5 - 1.7	

All dimensions in mm; 1 inch = 25.4 mm

Tolerances according: ISO 2768-m/EN 22768-m

Please visit www.schaffner.com to find more details on filter connectors.

Headquarters, Global Innovation and Development

Switzerland

Schaffner Group

Industrie Nord
Nordstrasse 5
4542
Luterbach
+41 32 681 66 26
info@schaffner.com

Sales and Application Centers

Finland

Schaffner Oy

Lohjanharjuntie 1109
08500
Lohja
+ 358 50 468 72 84
finlandsales@schaffner.com

France

Schaffner EMC S.A.S.

16-20 Rue Louis Rameau
95875
Bezons
+33 1 34 34 30 60
francesales@schaffner.com

Germany

Schaffner Deutschland GmbH

Ohiostr. 8
76149
Karlsruhe
+49 721 56910
germanysales@schaffner.com

Italy

Schaffner EMC S.r.l.

Via Ticino, 30
20900
Monza (MB)
+39 335 120 44 32
italysales@schaffner.com

Japan

Schaffner EMC K.K.

ISM Sangenjaya 7F
1-32-12 Kamiyama Setagaya-ku
154-0011
Tokyo
+81 3 5712 3650
japansales@schaffner.com

Singapore

Schaffner EMC Pte Ltd.

Blk 3015A Ubi Road 1 #05-09 Kampong Ubi
Industrial Estate
408705
Singapore
+65 63773283
singaporesales@schaffner.com

Sweden

Schaffner EMC AB

Östermalmströgr 1
114 42
Stockholm
+46 8 5050 2425
swedensales@schaffner.com

Switzerland

Schaffner EMV AG

Industrie Nord
Nordstrasse 5
4542
Luterbach
+41 32 681 66 26
switzerlandsales@schaffner.com

India

Schaffner India Pvt. Ltd

Regus World Trade Centre
WTC 22nd Floor Unit No 2238 Brigade
Gateway Campus 26/1 Dr. Rajkumar Road
Malleshwaram (W)
560055
Bangalore
+91 8067935355
indiasales@schaffner.com

United Kingdom

Schaffner Ltd.

Suite 1 Oakmede Place
Terrace Road
RG42 4JF
Binfield
+44 118 9770070
schaffner.uksales@te.com

United States

Schaffner EMC Inc.

52 Mayfield Avenue
Edison, New Jersey
+1 732 225 9533
usasales@schaffner.com

To find your local partner within Schaffner's global network schaffner.com

© 2025 Schaffner Group

The content of this document has been carefully checked and understood. However, neither Schaffner nor its subsidiaries assume any liability whatsoever for any errors or inaccuracies of this document and the consequences thereof. Published specifications are subject to change without notice. Product suitability for any area of application must ultimately be determined by the customer. In all cases, products must never be operated outside their published specifications. Schaffner does not guarantee the availability of all published products. This disclaimer shall be governed by substantive Swiss law and resulting disputes shall be settled by the courts at the place of business of Schaffner Holding AG. Latest publications and a complete disclaimer can be downloaded from the Schaffner website. All trademarks recognized.

Looking for pricing, stock, or lifecycle information?

Click below to explore more details on WIN SOURCE:

 [View FN2090-12-06 on WIN SOURCE](#)

 [TE Connectivity Information](#)

Optimize Your Supply Chain with WIN SOURCE Solutions

-  Global Sourcing Solution
-  Obsolete Management
-  Cost Control Management
-  Shortage Management
-  Alternative Solution
-  Excess Inventory Management