



## GRF4005

### BROADBAND LNA / LINEAR DRIVER 0.1 to 3.8 GHz

#### FEATURES

- Flexible Bias Voltage and Current
- Internally Matched to 50  $\Omega$
- Process: GaAs pHEMT
- Compact 1.5 x 1.5 mm DFN-6 Package

#### Reference: 5 V / 170 mA / 2.5 GHz

- Gain: 12.8 dB
- OIP3: 42 dBm
- OP1dB: 27.5 dBm
- Evaluation Board Noise Figure: 0.88 dB

#### APPLICATIONS

- Linear Driver Amplifier
- Small Cells and Cellular Repeaters
- Distributed Antenna Systems
- First/Second Stage LNA

#### DESCRIPTION

The GRF4005 is a broadband low noise gain block designed for small cell, wireless infrastructure and other high-performance applications. With simple external matching, it exhibits outstanding broadband noise figure (NF), linearity and return losses over wide fractional bandwidths with a single match.

Configured as a first stage LNA, linear driver or cascaded gain block, GRF4005 offers high levels of reuse both within a design and across platforms. The device is operated from a supply voltage ( $V_{DD}$ ) of 1.8 to 5.5 volts.  $I_{DDQ}$  can be adjusted over a wide range for optimal efficiency and linearity.

Please consult with the GRF applications engineering team for custom tuning/evaluation board data and S-parameters.

Additional tunes can be found on the GRF4005 "Custom Tunes" product page: [GRF4005 Custom Tunes](#)

#### BLOCK DIAGRAM

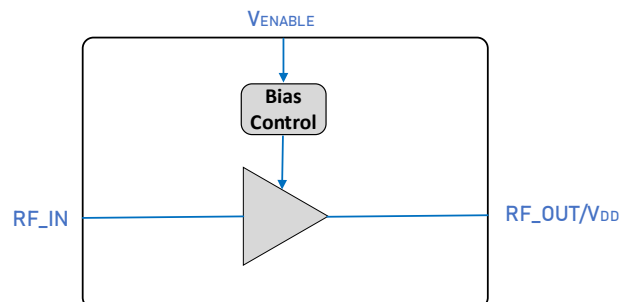

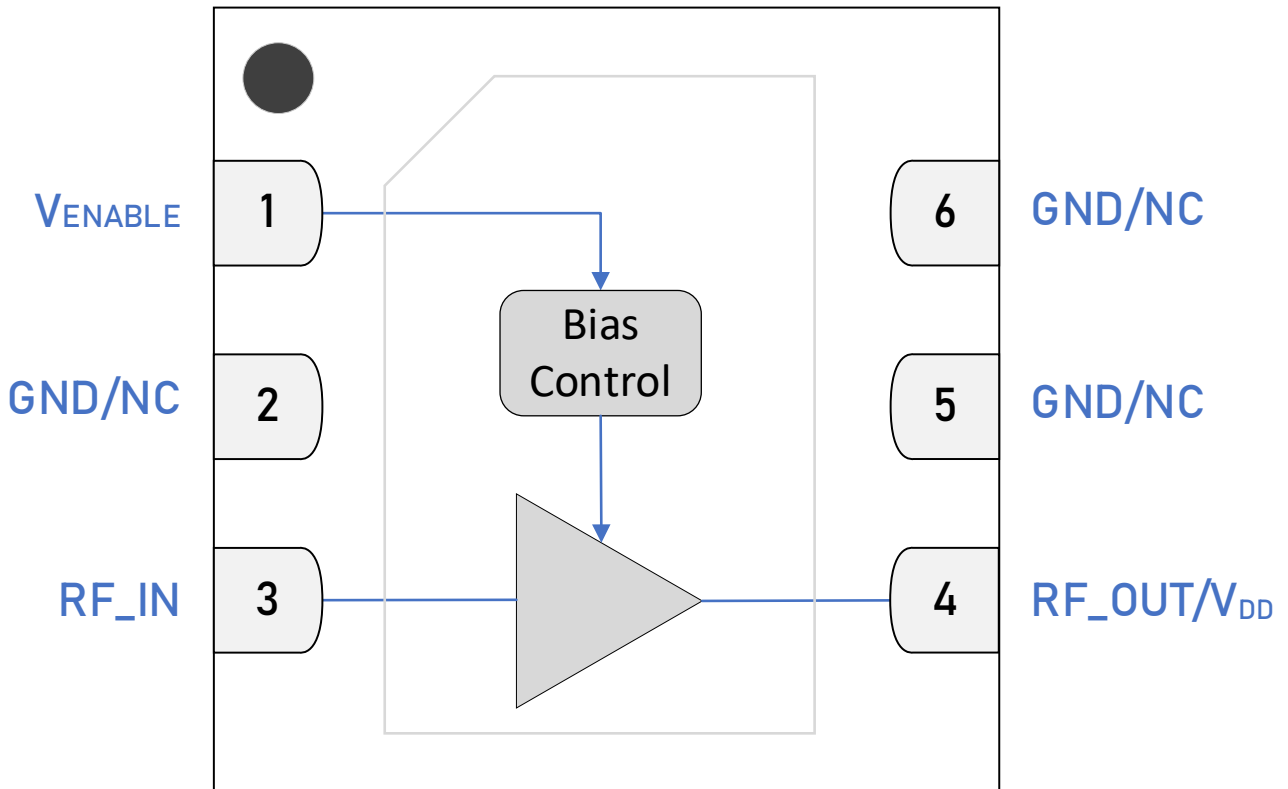

1.5 x 1.5 mm DFN-6 Pin Out (Top View)

## Pin Assignments

Pin	Name	Description	Note
1	V <sub>ENABLE</sub>	Enable Voltage Input	V <sub>ENABLE</sub> and series resistor set I <sub>DDQ</sub> . V <sub>ENABLE</sub> ≤ 0.2 volts disables device. On die pull-down resistor will turn the device off if this node is allowed to float.
2, 5, 6	GND/NC	Ground or No Connect	No internal connection to die. We recommend connecting these pins to ground.
3	RF_IN	LNA RF Input	An external DC blocking capacitor must be used.
4	RF_OUT/V <sub>DD</sub>	LNA RF Output	V <sub>DD</sub> must be applied through a choke to this pin.
PKG BASE	GND	Ground	Provides DC and RF ground for LNA, as well as thermal heat sink. Recommend multiple 8 mil vias beneath the package for optimal RF and thermal performance. Refer to evaluation board top layer graphic on schematic page.

## Absolute Ratings

Parameter	Symbol	Min.	Max.	Unit
Supply Voltage	$V_{DD}$	0	6	V
RF Input Power: Load VSWR < 2:1, $V_{DD} = 5$ V.	$P_{IN\ MAX}$		22	dBm
Operating Temperature (package base).	$T_{PKG\ BASE}$	-40	105	°C
Maximum Channel Temperature (MTTF > $10^6$ hours).	$T_{MAX}$		170	°C
Maximum Dissipated Power	$P_{DISS\ MAX}$		850	mW

## Electrostatic Discharge

Human Body Model	HBM	500		V
------------------	-----	-----	--	---

## Storage

Storage Temperature	$T_{STG}$	-65	150	°C
Moisture Sensitivity Level	MSL		1	--



**Caution! ESD Sensitive Device.**

**Exceeding Absolute Maximum Rating conditions may cause permanent damage.**

Note: For additional information, please refer to [Package Manufacturing Information | Guerrilla RF \(guerrilla-rf.com\)](#)



All Guerrilla RF products are provided in RoHS compliant lead (Pb)-free packaging requiring no exemptions. Additional information for this topic can be found at this link - [Environmental and Restricted Substance Statement Library](#)

## Recommended Operating Conditions

Parameter	Symbol	Specification			Unit	Condition
		Min.	Typ.	Max.		
Supply Voltage	$V_{DD}$	1.8	5	6	V	
Operating Temperature (package base)	$T_{PKG\ BASE}$	-40		105	°C	
RF Frequency Range	$F_{RF}$	0.1	2.5	3.8	GHz	Typical application schematic with external matching components ( <b>notes 1 &amp; 2</b> ).
RF_IN Port Impedance	$Z_{RF\_IN}$		50		$\Omega$	
RF_OUT Port Impedance	$Z_{RF\_OUT}$		50		$\Omega$	

**Note 1:** Operation outside of this range is supported by using different custom tunes. Examples of other optimized tunes can be found here: [GRF4005 Custom Tunes](#).

**Note 2:** Contact the Guerrilla RF applications team for guidance on optimizing the tuning of the device for alternative bands.

## Nominal Operating Parameters – General

The following conditions apply unless noted otherwise: typical application schematic using the 0.1 to 3.8 GHz tuning set.  $V_{DD} = 5\text{ V}$ ,  $F_{TEST} = 2.5\text{ GHz}$ ,  $50\ \Omega$  system impedance,  $T_{PKG\ BASE} = 25\ ^\circ\text{C}$ . Evaluation board losses are included within the specifications.

Parameter	Symbol	Specification			Unit	Condition
		Min.	Typ.	Max.		
Supply Current	$I_{DD}$	145	170	195	mA	$V_{DD} = 5\text{ V}$ , $V_{ENABLE} = 5\text{ V}$ .
Switching Rise Time	$T_{RISE}$		500		ns	Gain mode to Disabled mode ( <b>note 3</b> ).
Switching Fall Time	$T_{FALL}$		500		ns	Disabled mode to Gain mode ( <b>note 4</b> ).

### Disabled Mode

Leakage Current	$I_{LEAKAGE}$		4.5	20	$\mu\text{A}$	$V_{DD} = 5\text{ V}$ , $V_{ENABLE} = 0\text{ V}$ .
-----------------	---------------	--	-----	----	---------------	---

### Thermal Data

Thermal Resistance (Infrared Scan)	$\Theta_{JC}$		87		$^\circ\text{C}/\text{W}$	On standard evaluation board ( <b>note 5</b> ).
------------------------------------	---------------	--	----	--	---------------------------	---

**Note 3:** Switching Time: 50% of  $V_{ENABLE}$  to 90% of  $P_{OUT}$ .

**Note 4:** Switching Time: 50% of  $V_{ENABLE}$  to 10% of  $P_{OUT}$ .

**Note 5:** MTTF >  $10^6$  hours for  $T_{CHANNEL} \leq 170\ ^\circ\text{C}$ .

## Nominal Operating Parameters – RF

The following conditions apply unless noted otherwise: typical application schematic using the 0.1 to 3.8 GHz tuning set.  $V_{DD} = 5\text{ V}$ ,  $F_{TEST} = 2.5\text{ GHz}$ ,  $50\ \Omega$  system impedance,  $T_{PKG\ BASE} = 25\ ^\circ\text{C}$ . Evaluation board losses are included within the specifications.

Parameter	Symbol	Specification			Unit	Condition
		Min.	Typ.	Max.		
Gain	S21	11.8	12.8		dB	
Noise Figure	NF		0.88	1.05	dB	On standard evaluation board.
Output 3 <sup>rd</sup> Order Intercept Point	OIP3		42		dBm	2 dBm $P_{OUT}$ per tone at 2 MHz spacing (2499 and 2501 MHz).
Output 1 dB Compression Power	OP1dB	26	27.5		dBm	

GRF4005 Typical Operating Curves: 1.7 to 2.7 GHz Tune

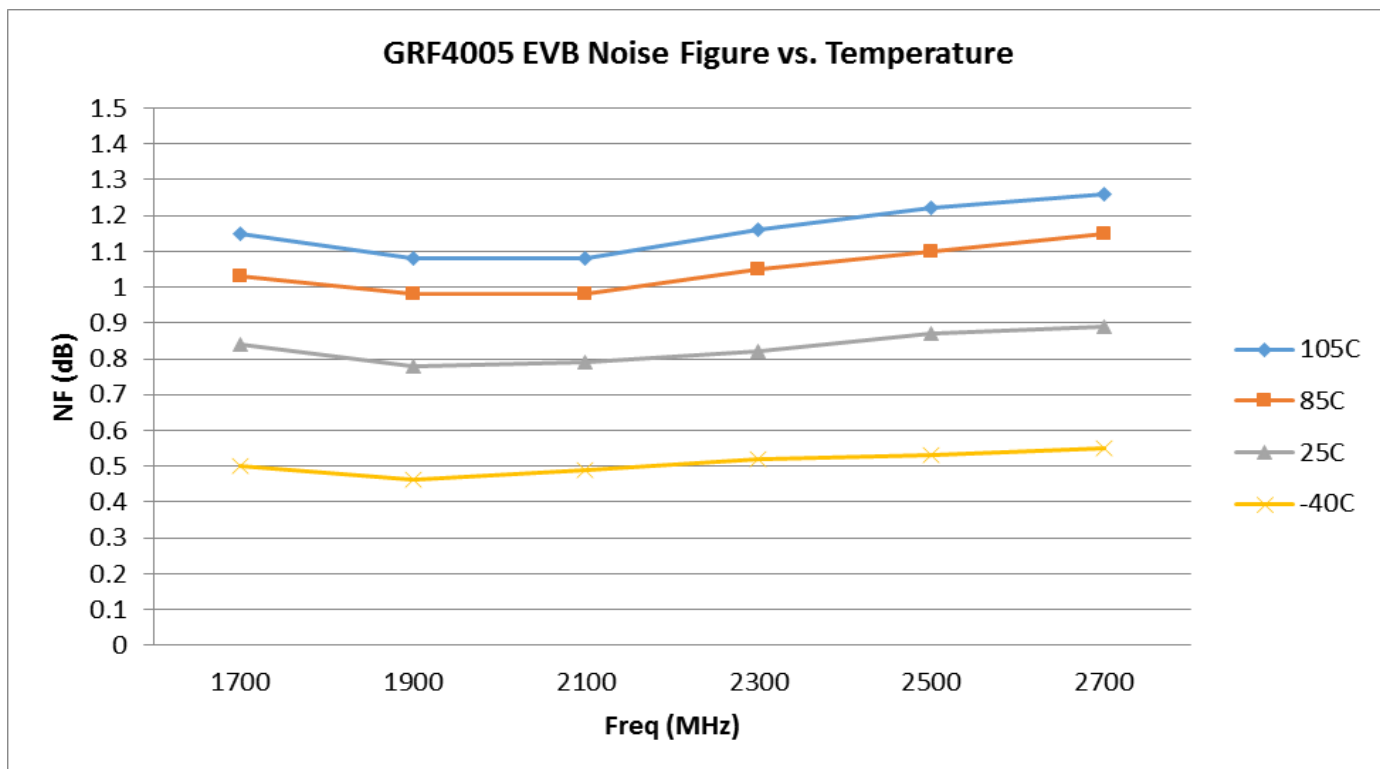
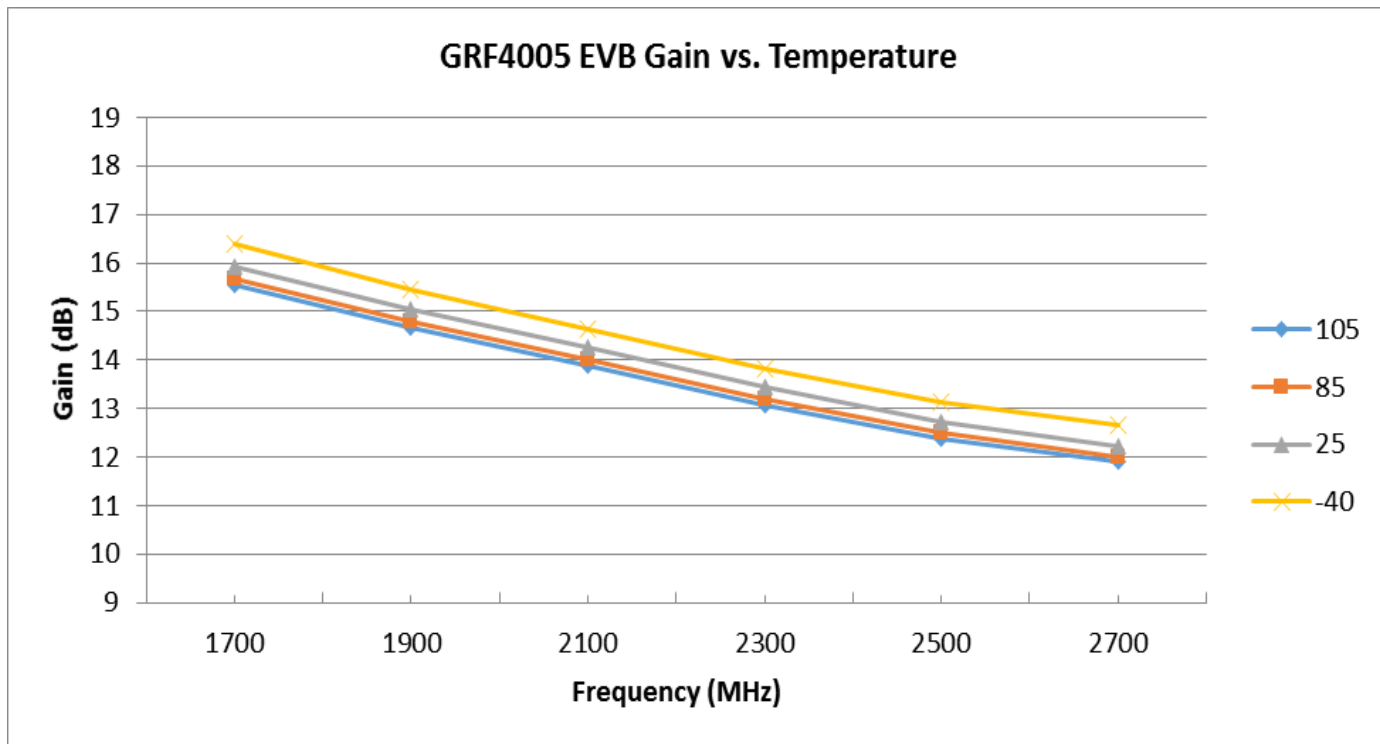

GRF4005 Typical Operating Curves: 1.7 to 2.7 GHz Tune

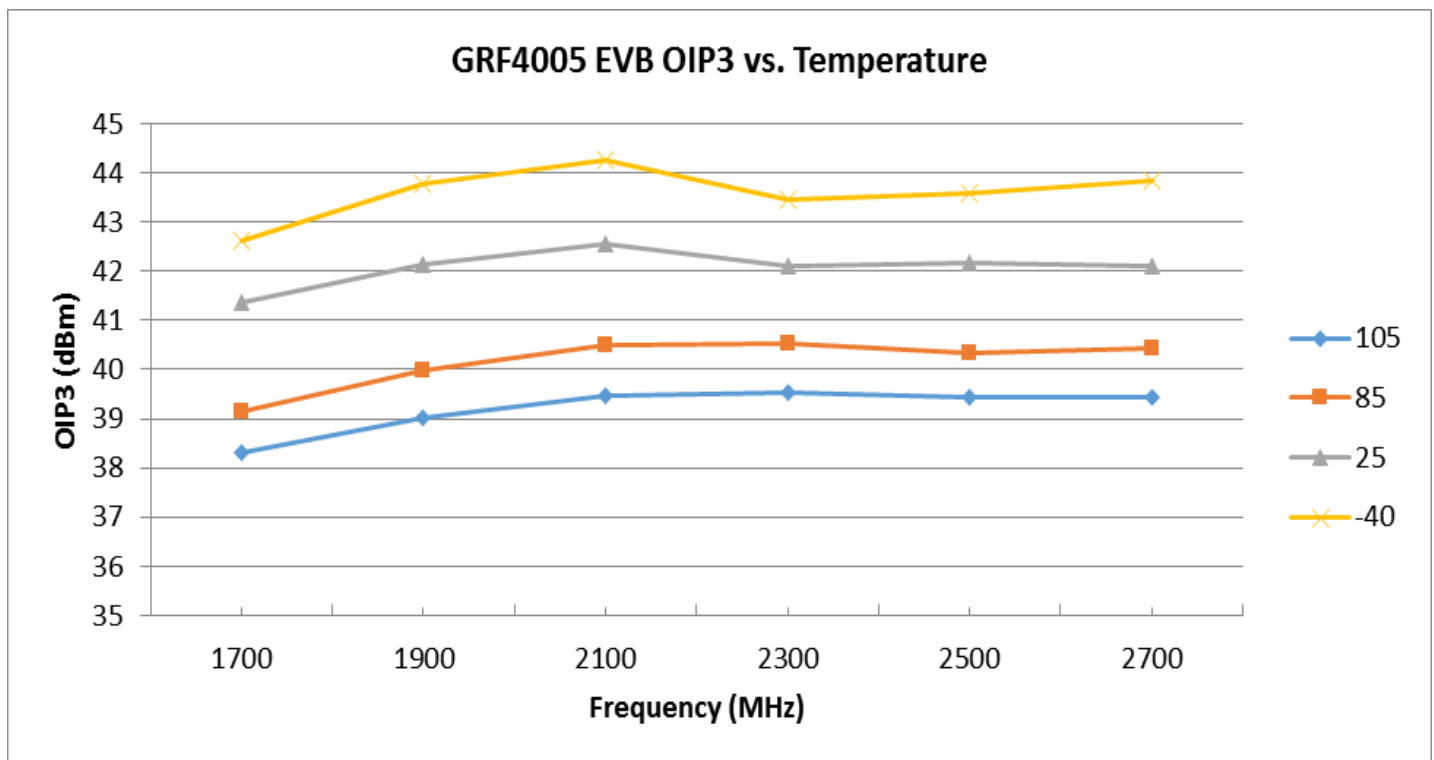
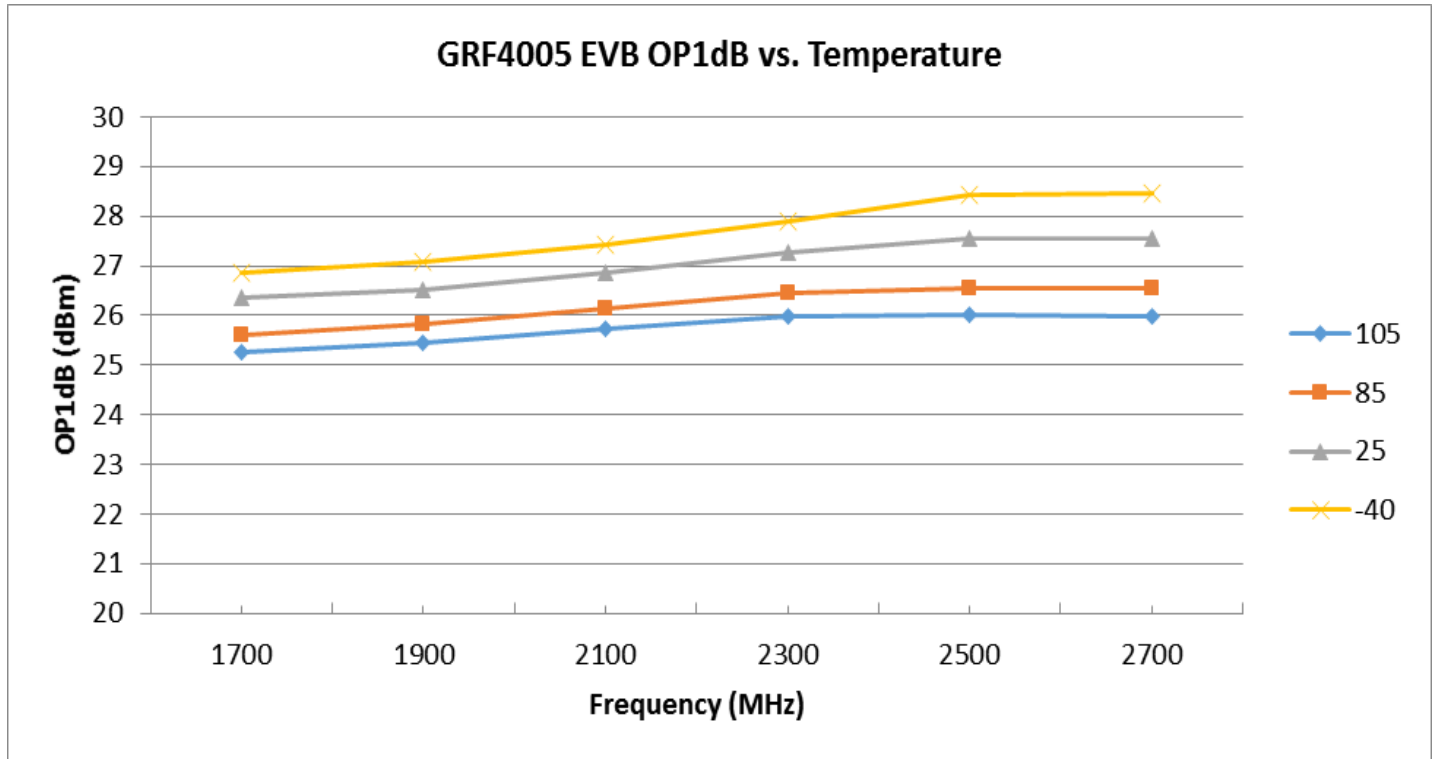

### GRF4005 Typical Operating Curves: S-Parameters (1.7 to 2.7 GHz Tune)

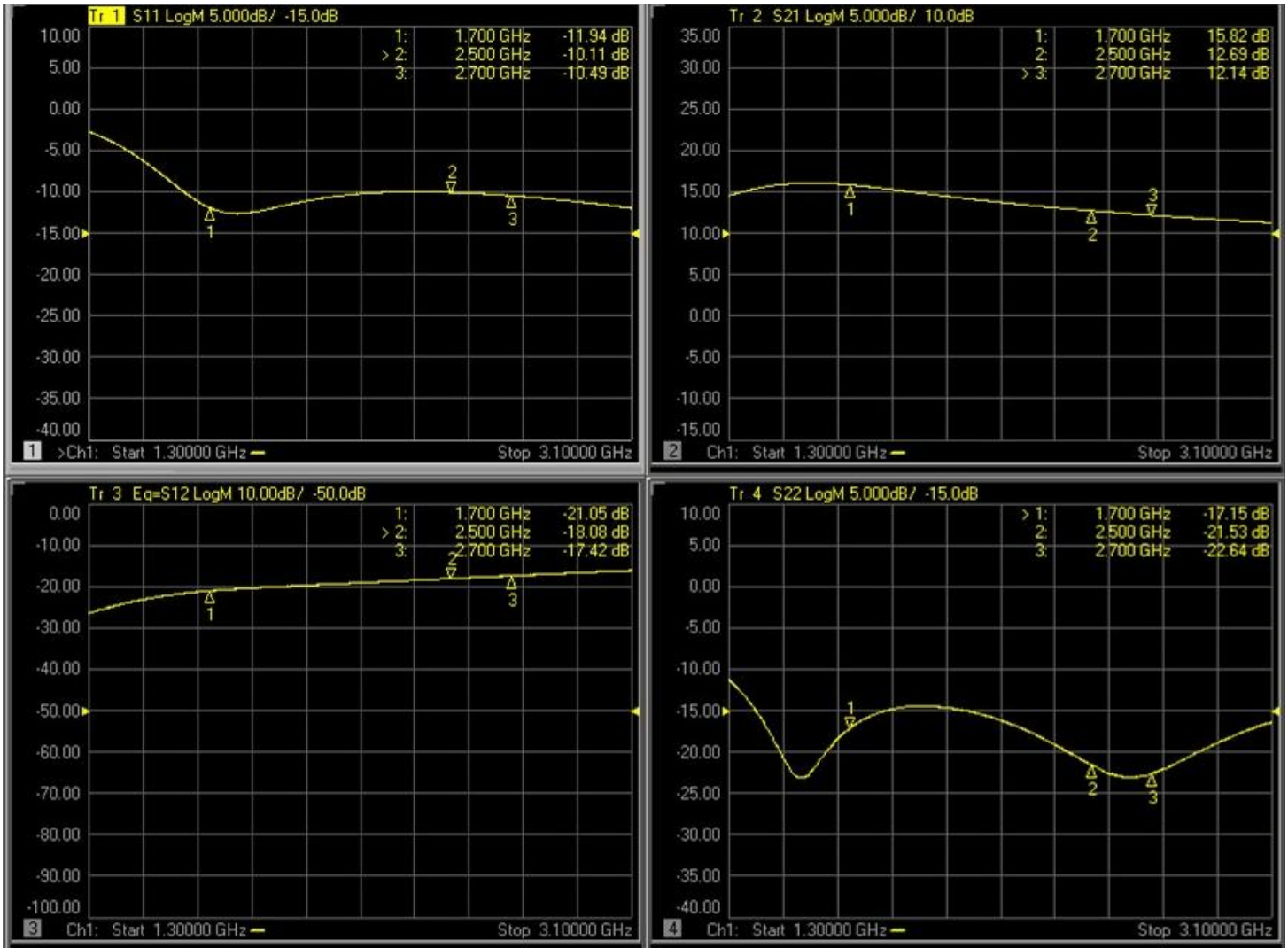

GRF4005 Typical Operating Curves: Stability Mu Factor (10 MHz to 20 GHz)

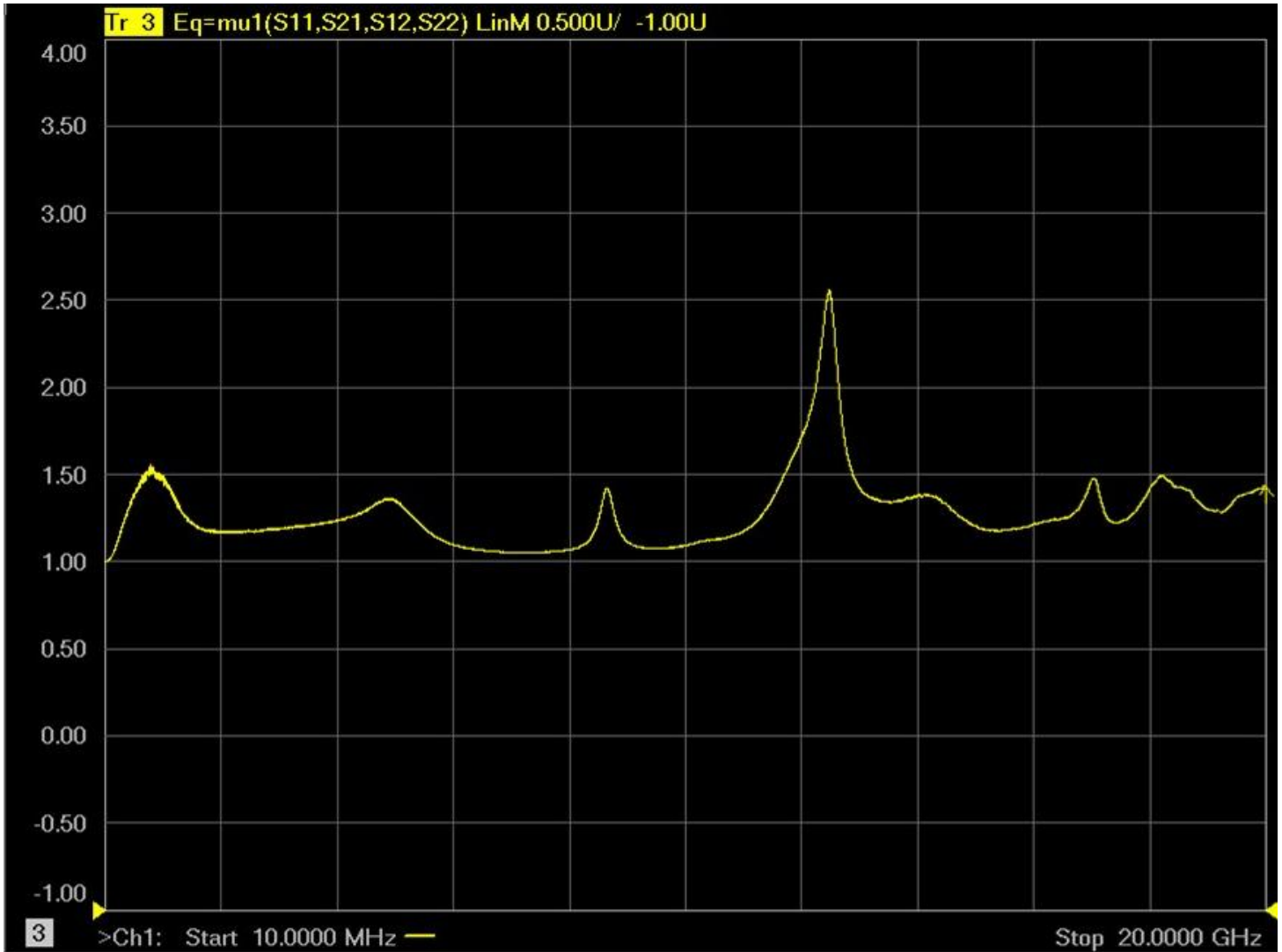

Note:  $\mu \geq 1.0$  implies unconditional stability.

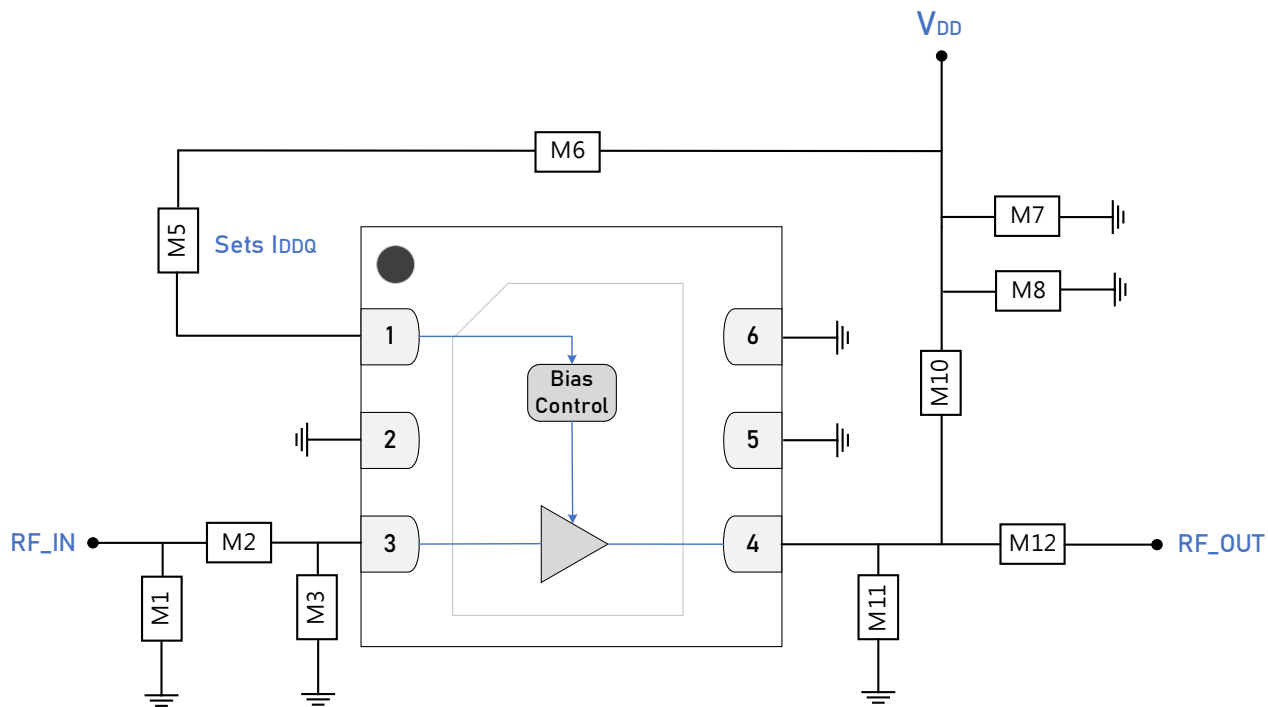

GRF4005 Standard Evaluation Board Schematic

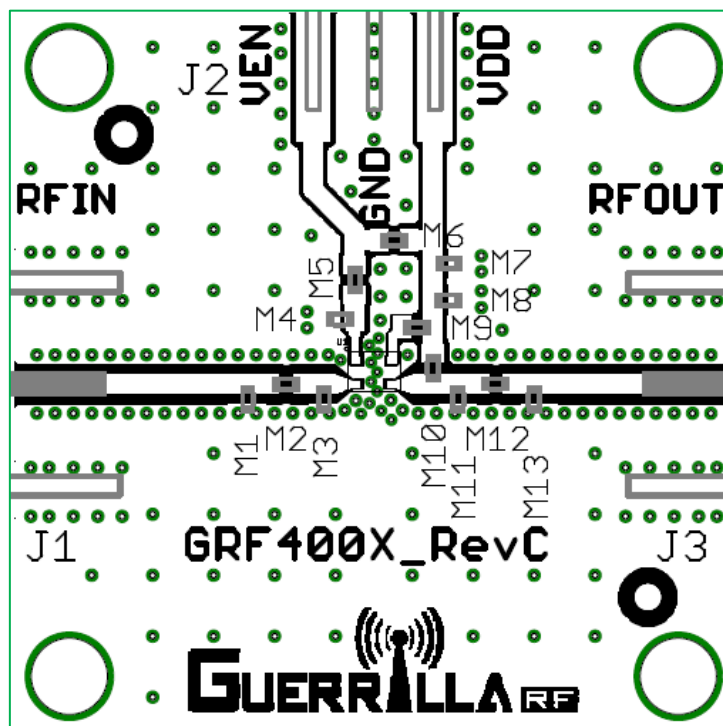

GRF4005 Evaluation Board Assembly Diagram

**GRF4005 Evaluation Board Assembly Diagram Reference: 1.7 to 2.7 GHz Tune**

Component	Type	Manufacturer	Family	Value	Package Size	Substitution
M1	Inductor	Coilcraft	HPA	3.3 nH	0402	ok
M2	Capacitor	Murata	GJM	2.0 pF	0402	ok
M3	Capacitor	Murata	GJM	1.5 pF	0402	ok
M5 (sets I <sub>DDQ</sub> )	Resistor	Various	5%	see curves	0402	ok
M6	Resistor (jumper)	Various	5%	0 Ω	0402	ok
M7	Capacitor	Murata	GRM	0.1 μF	0402	ok
M8	Capacitor	Murata	GRM	27.0 pF	0402	ok
M10	Inductor	Coilcraft	HPA	18.0 nH	0402	ok
M11	Capacitor	Murata	GJM	1.0 pF	0402	ok
M12	Capacitor	Murata	GJM	15.0 pF	0402	ok
Evaluation Board	GRF400X_RevC					

**GRF4005 Bias Resistor Selection Curves**

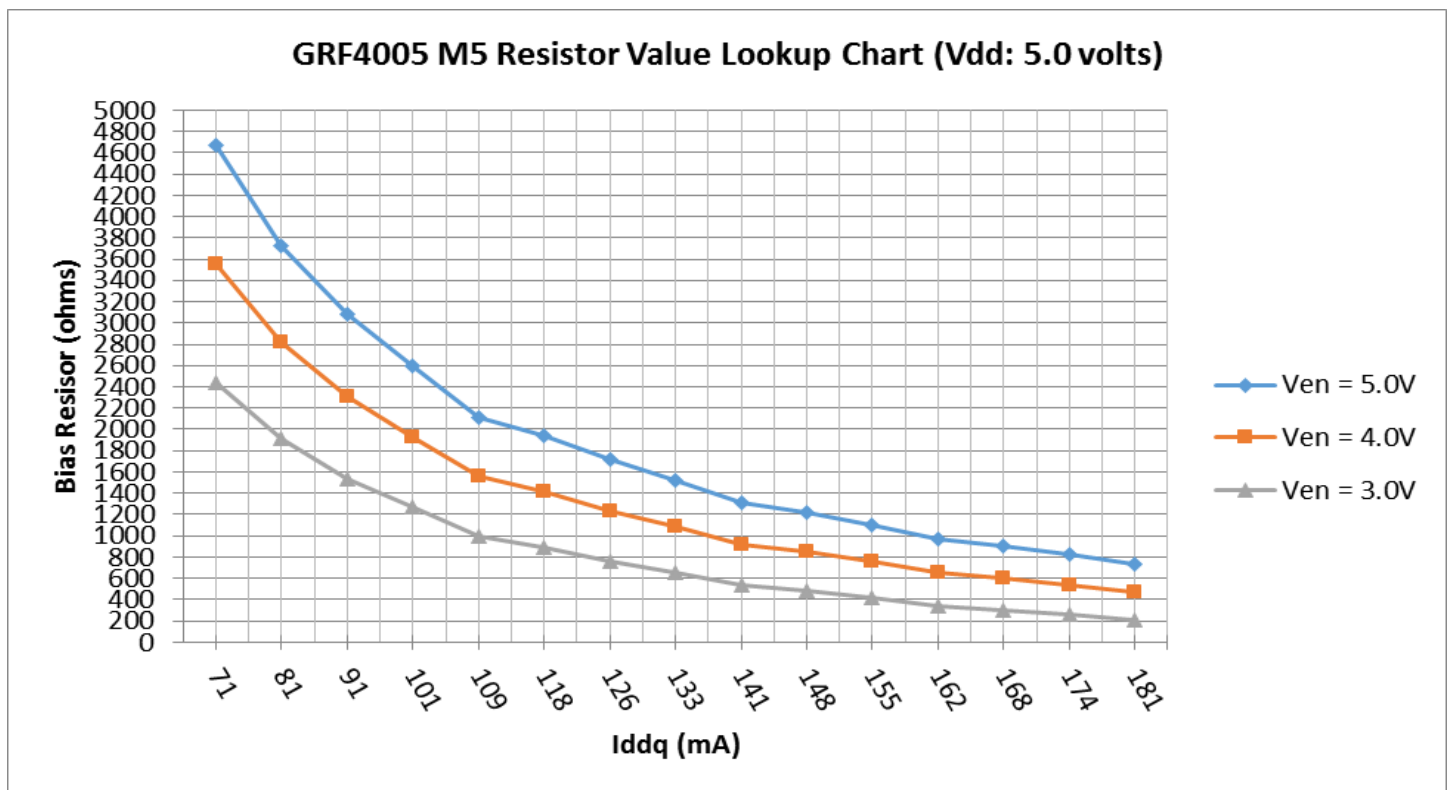



## Package Marking Diagram

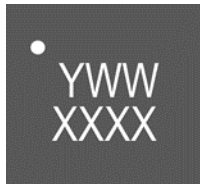

- Line 1: "Y" = YEAR (single digit). "WW" = WORK WEEK the device was assembled.
- Line 2: "XXXX" = Device PART NUMBER.

## Tape and Reel Information

Guerrilla RF's tape and reel specification complies with Electronic Industries Alliance (EIA) standards for "Embossed Carrier Tape of Surface Mount Components for Automatic Handling" (reference EIA-481). See the following page for the Tape and Reel Specification and Device Package Information table, which includes units per reel.

Devices are loaded with pins down into the carrier pocket with protective cover tape and reeled onto a plastic reel. Each reel is packaged in a cardboard box. There are product labels on the reel, the protective ESD bag and the outside surface of the box.

For the Tape and Reel Reference Table, please refer to: [Package Manufacturing Information | Guerrilla RF \(guerrilla-rf.com\)](#)

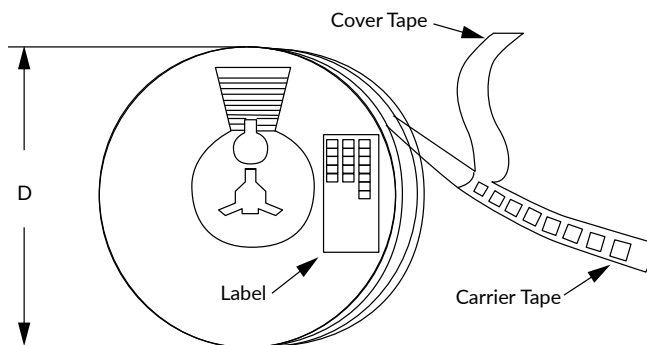

Tape and Reel Packaging with Reel Diameter Noted (D)

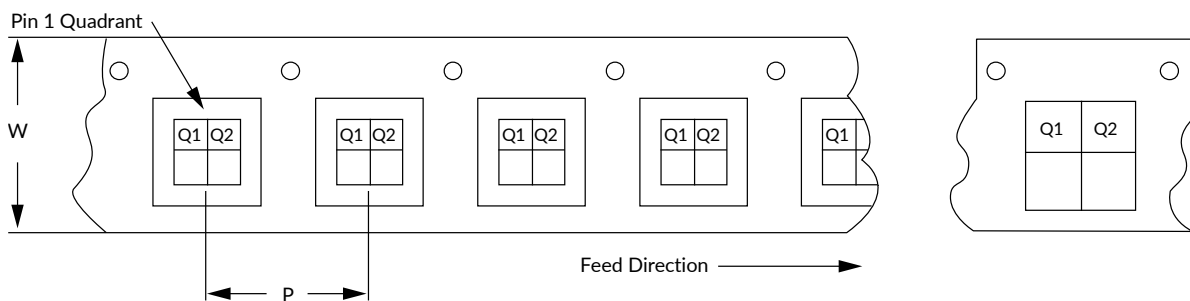

Carrier Tape Width (W), Pitch (P), Feed Direction and Pin 1 Quadrant Information



## Revision History

Revision Date	Description of Change
May 9, 2017	Release A Data Sheet.
February 20, 2025	Upgraded Data Sheet to new format only. No change to device or device specifications.
January 8, 2026	Changed evaluation board to GRF400X_RevC.



### Data Sheet Classifications

Data Sheet Status	Notes
Advance	S-parameter and NF data based on EM simulations for the fully packaged device using foundry-supplied transistor S-parameters. Linearity estimates based on device size, bias condition and experience with related devices.
Preliminary	All data based on limited evaluation board measurements taken within the Guerrilla RF Applications Lab. All parametric values are subject to change pending the collection of additional data.
Release Ø	All data based on measurements taken with <i>production-released</i> material. TYP values are based on a combination of ATE and bench-level measurements, with MIN/MAX limits defined using <i>modelled estimates</i> that account for part-to-part variations and expected process spreads. Although unlikely, future refinements to the TYP/MIN/MAX values may be in order as multiple lots are processed through the factory.
Release A-Z	All data based on measurements taken with production-released material <i>derived from multiple lots which have been fabricated over an extended period of time</i> . MIN/MAX limits may be refined over previous releases as more statistically significant data is collected to account for process spreads.

Information in this data sheet is specific to the Guerrilla RF, Inc. ("Guerrilla RF") product identified.

This data sheet, including the information contained in it, is provided by Guerrilla RF as a service to its customers and may be used for informational purposes only by the customer. Guerrilla RF assumes no responsibility for errors or omissions on this data sheet or the information contained herein. Information provided is believed to be accurate and reliable, however, no responsibility is assumed by Guerrilla RF for its use, nor for any infringement of patents, or other rights of third parties, resulting from its use. Guerrilla RF assumes no liability for any data sheet, data sheet information, materials, products, product information, or other information provided hereunder, including the sale, distribution, reproduction or use of Guerrilla RF products, information, or materials.

No license, whether express, implied, by estoppel, by implication or otherwise is granted by this data sheet for any intellectual property of Guerrilla RF, or any third party, including without limitation, patents, patent rights, copyrights, trademarks, and trade secrets. All rights are reserved by Guerrilla RF.



All information herein, products, product information, data sheets, and data sheet information are subject to change and availability without notice. Guerrilla RF reserves the right to change component circuitry, recommended application circuitry and specifications at any time without prior notice. Guerrilla RF may further change its data sheet, product information, documentation, products, services, specifications, or product descriptions at any time, without notice. Guerrilla RF makes no commitment to update any materials or information and shall have no responsibility whatsoever for conflicts, incompatibilities, or other difficulties arising from any future changes.

GUERRILLA RF INFORMATION, PRODUCTS, PRODUCT INFORMATION, DATA SHEETS AND DATA SHEET INFORMATION ARE PROVIDED "AS IS" AND WITHOUT WARRANTY OF ANY KIND, WHETHER EXPRESS, IMPLIED, STATUTORY, OR OTHERWISE, INCLUDING FITNESS FOR A PARTICULAR PURPOSE OR USE, MERCHANTABILITY, PERFORMANCE, QUALITY OR NON-INFRINGEMENT OF ANY INTELLECTUAL PROPERTY RIGHT; ALL SUCH WARRANTIES ARE HEREBY EXPRESSLY DISCLAIMED. GUERRILLA RF DOES NOT WARRANT THE ACCURACY OR COMPLETENESS OF THE INFORMATION, TEXT, GRAPHICS OR OTHER ITEMS CONTAINED WITHIN THESE MATERIALS. GUERRILLA RF SHALL NOT BE LIABLE FOR ANY DAMAGES, INCLUDING BUT NOT LIMITED TO ANY SPECIAL, INDIRECT, INCIDENTAL, STATUTORY, OR CONSEQUENTIAL DAMAGES, INCLUDING WITHOUT LIMITATION, LOST REVENUES OR LOST PROFITS THAT MAY RESULT FROM THE USE OF THE MATERIALS OR INFORMATION, WHETHER OR NOT THE RECIPIENT OF MATERIALS HAS BEEN ADVISED OF THE POSSIBILITY OF SUCH DAMAGE.

Customers are solely responsible for their use of Guerrilla RF products in the Customer's products and applications or in ways which deviate from Guerrilla RF's published specifications, either intentionally or as a result of design defects, errors, or operation of products outside of published parameters or design specifications. Customers should include design and operating safeguards to minimize these and other risks. Guerrilla RF assumes no liability or responsibility for applications assistance, customer product design, or damage to any equipment resulting from the use of Guerrilla RF products outside of stated published specifications or parameters.

## Looking for pricing, stock, or lifecycle information?

Click below to explore more details on WIN SOURCE:

-  [View GRF4005 on WIN SOURCE](#)
-  [Guerrilla RF, Inc. Information](#)

## Optimize Your Supply Chain with WIN SOURCE Solutions

-  Global Sourcing Solution
-  Obsolete Management
-  Cost Control Management
-  Shortage Management
-  Alternative Solution
-  Excess Inventory Management