

Single phase 250Vac 3 to 300A EMC Filters with DIN rail option

https://product.tdk.com/en/search/emc/emc/power-line/tec_data/nf_rsen

<https://www.emea.lambda.tdk.com/uk/products/r-series>

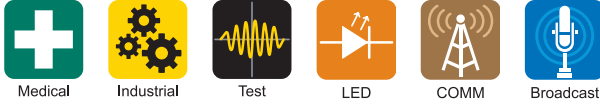

The RSEN single-phase EMC filters are enclosed in a compact case and part numbers up to 300A can be either chassis or DIN rail mounted (up to 300A) with low leakage current options. They are rated for 250Vac with fifteen current ratings of 3 to 300A enabling the optimum attenuation to match the current rating. The series uses TDK's ferrite core material to provide noise attenuation. The connection terminals are integrated into the case with both the screws and terminal covers captive. This avoids dropped or lost hardware. The RSEN 3A to 300A models are UL certified for a short circuit current rating of up to 14kA and the 40, 50 and 60A models 35kA with the appropriate breaker.

Features	Benefits
• 3 to 300A Current Ratings	• Optimizes the Attenuation for the Current Rating
• DIN Rail Bracket Option	• Flexible Mounting
• Captive Hardware	• No Lost Screws or Terminal Covers
• Safety Certified	• Global Use

Model Selector								
Model	Rated Current (A)	SCCR (kA) ⁽¹⁾	HV Pulse Protection	Leakage Current 250V/60Hz (mA)	Maximum DC Resistance (mΩ)	Attenuation frequency range (MHz)		
						Common mode at 25dB	Common mode at 10dB	Differential mode at 25dB
RSEN-2003	3	14	N	1.0	250	0.1 to 20	-	0.2 to 30
RSEN-2006	6	14	N	1.0	110	0.1 to 10	-	0.2 to 30
RSEN-2010	10	14	N	1.0	40	0.2 to 20	-	0.2 to 30
RSEN-2016	16	14	N	1.0	20	0.3 to 20	-	0.3 to 30
RSEN-2020	20	14	N	1.0	10	0.4 to 20	-	0.3 to 30
RSEN-2030	30	14	N	1.0	6	2 to 30	-	0.4 to 30
RSEN-2040	40	35	N	1.0	6	2 to 10	-	0.2 to 30
RSEN-2050	50	35	N	1.0	4	2 to 10	-	0.2 to 30
RSEN-2060	60	35	N	1.0	3	2 to 10	-	0.2 to 30
RSEN-2080	80	-	N	1.0	3.4	2 to 10	-	0.1 to 30
RSEN-2100	100	-	N	1.0	2.7	2 to 10	-	0.1 to 30
RSEN-2150	150	-	N	1.0	2	2 to 10	-	0.1 to 30
RSEN-2200	200	-	N	1.0	1.4	-	0.4 to 30	0.1 to 30
RSEN-2250	250	-	N	1.0	1	-	1 to 20	0.1 to 30
RSEN-2300	300	-	N	1.0	0.7	-	2 to 20	0.1 to 30

Model Selector								
Model	Rated Current (A)	SCCR (kA) ⁽¹⁾	HV Pulse Protection	Leakage Current 250V/60Hz (mA)	Maximum DC Resistance (mΩ)	Attenuation frequency range (MHz)		
						Common mode at 25dB	Common mode at 10dB	Differential mode at 25dB
RSEN-2003L	3	14	N	0.01	250	0.1 to 3	-	0.2 to 30
RSEN-2006L	6	14	N	0.01	110	0.1 to 3	-	0.2 to 30
RSEN-2010L	10	14	N	0.01	40	-	0.1 to 10	0.2 to 30
RSEN-2016L	16	14	N	0.01	20	-	0.1 to 10	0.2 to 30
RSEN-2020L	20	14	N	0.01	10	-	0.2 to 10	0.3 to 30
RSEN-2030L	30	14	N	0.01	6	-	0.3 to 5	0.3 to 30

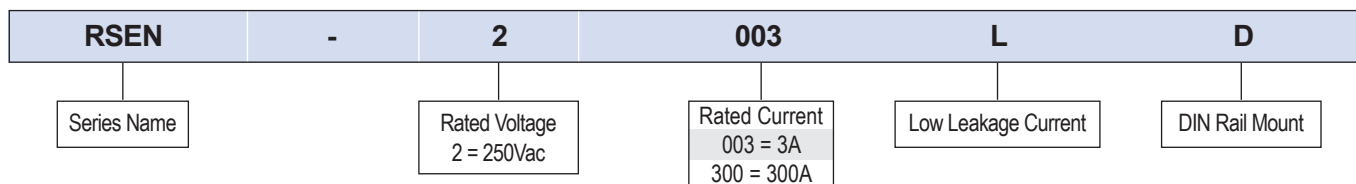

Related Products									
Type	Current Rating (A)	Series	Low Leakage	Faston on Terminals	Wire Leads	DIN Rail Mount	Fused	Discharge Resistor	Metal Case
Board mount line filter, HV Pulse	0.5 - 6	RSAG							
Board mount line filter	0.5 - 6	RSEG							
General purpose with faston terminals	6	RSEC							
General purpose	0.5 - 6	RSEL	Y	Y	Y				Y
HV pulse protection	0.5 - 6	RSAL	Y	Y	Y				
Power Entry Module with line filter	3, 6, 10	RPE	Y				Y	Y	
Power Entry Module with line filter, HV Pulse	3, 6, 10	RPA	Y					Y	
Compact size with screw terminals	6 - 30	RSEV				DIN-RSEV*			
Multipurpose	3 - 300	RSEN	Y (Up to 30A)			Y (Up to 30A)			
Multipurpose with HV pulse protection	3 - 60	RSAN	Y (Up to 30A)			Y (Up to 30A)			
High attenuation	3 - 300	RSHN	Y (Up to 30A)			Y (Up to 30A)			
High attenuation with pulse protection	3 - 300	RSMN	Y (Up to 30A)			Y (Up to 30A)			
Wide band, high attenuation	6 - 30	RSKN							

* Separate mounting bracket
[Click here for TDK-Lambda three phase filters.](#)

Specification		
Model		
Input		
Rated Voltage	Vac/Vdc	250 (Safety certified for AC input only)
Input Frequency	Hz	47 - 63
Leakage Current	-	See model selector
Safety Certifications and Markings	-	UL1283, CSA C22.2 No.8 (cUL), EN60939-1, -2), conforms to RoHS Directive
Environmental		
Operating Temperature	°C	-25 to +85, derating above 50-55. See derating curves below
Storage Temperature	°C	-25 to +85
Humidity (non condensing)	%RH	Operating and storage 15 - 85
Cooling	-	Convection
Withstand Voltage	Vac	2,500 input to earth
Isolation Resistance (For 1 minute)	MΩ	>100 at 500Vdc
Vibration	-	10-55Hz Amplitude 1.5mm, Sweep for 1 min. X, Y and Z directions for 2 hours each
Other		
Weight (Typ)	g	RSEN2003: 170, RSEN2006-2030: 230, RSEN2040-2060: 870, RSEN2080: 360 RSEN2100: 380, RSEN2150: 580, RSEN2200: 840, RSEN2250: 810, RSEN2300: 780
Size (LxWxH)	mm	See outline drawings
Size (LxWxH)	Inches	-
Connectors		See outline drawings
MIL-HDBK-217F NOTICE2	Hours	RSEN2003: 6,914,673, RSEN2300: 5,235,054
Warranty	Years	5

Notes
 (1) With inverse time circuit breaker. See UL 508 report on website
 See website for detailed specifications, test methods and installation manual
[RSEN technical files](#)

Mechanical Specification

Derating Curve RSEN-2003 to 2060

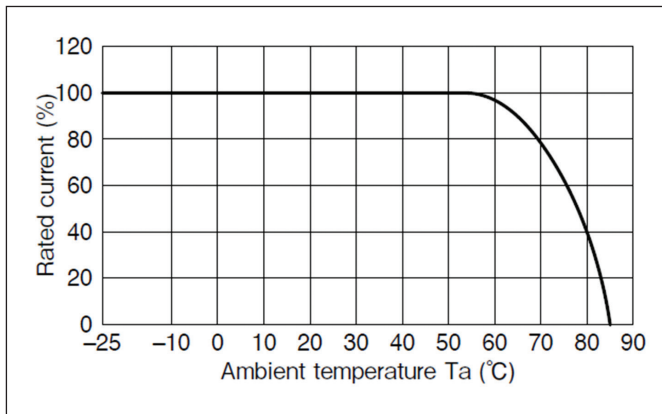

Derating Curve RSEN-2080 to 2300

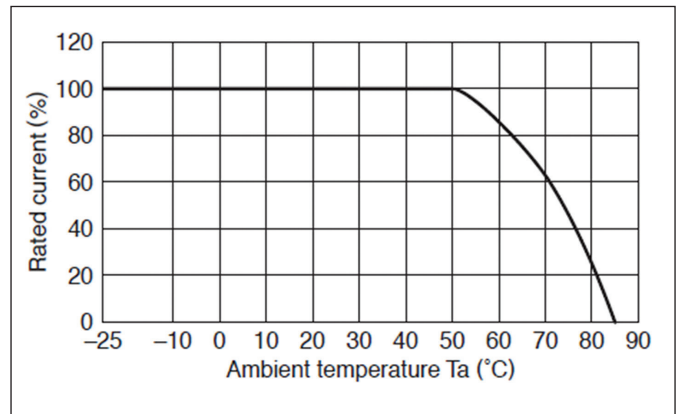

Schematic standard leakage current

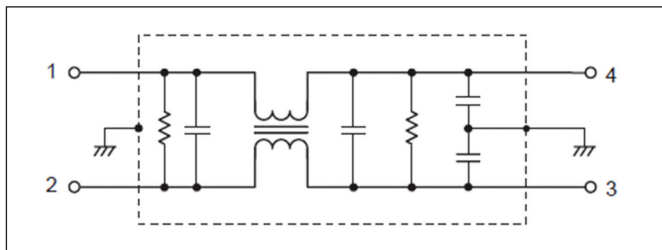

Schematic low leakage current (L option)

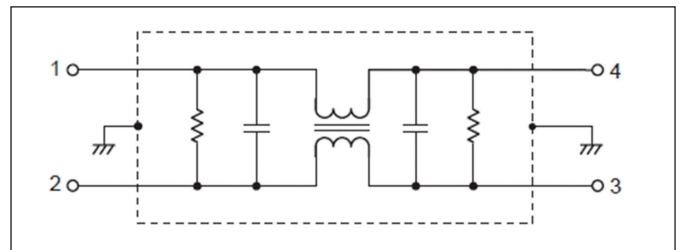

RSEN2003-2060 Outline Drawing

RSEN-2003/2006/2010/2016/2020/2030

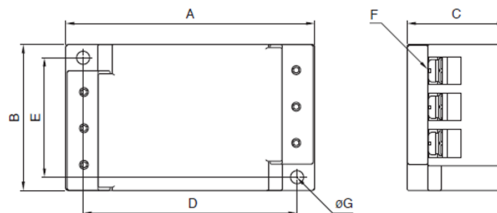

RSEN-2040/2050/2060

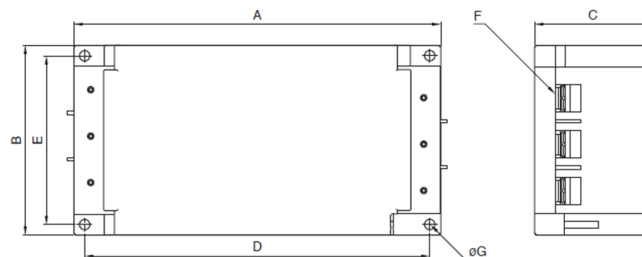

Dimensions in mm

Part No.	A	B	C	D	E	F	φG	Recommended clamping torque
RSEN-2003	87	52	35	75	43	M4	4.5	1.27N · m
RSEN-2006								
RSEN-2010								
RSEN-2016								
RSEN-2020								
RSEN-2030								
RSEN-2040	170	90	54	160	80	M5	4.5	2.5N · m
RSEN-2050								
RSEN-2060								

DIN-RSEN Outline Drawing

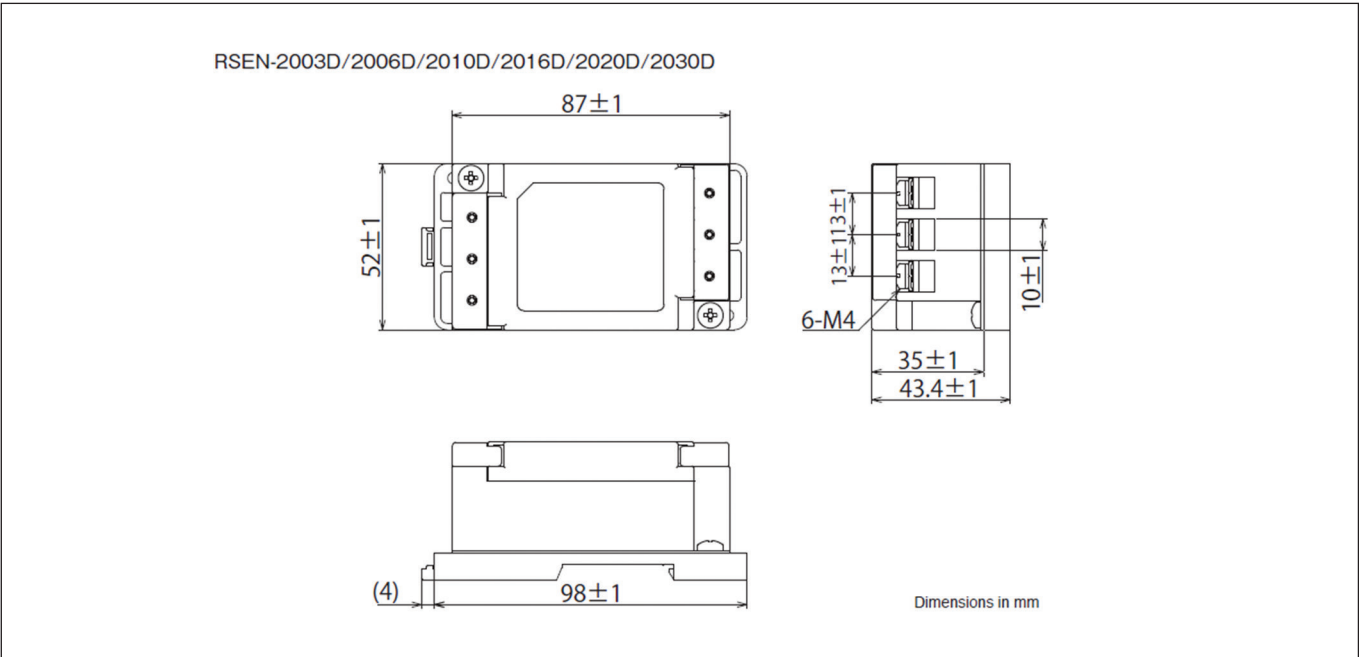

RSEN2080-2300 Outline Drawing

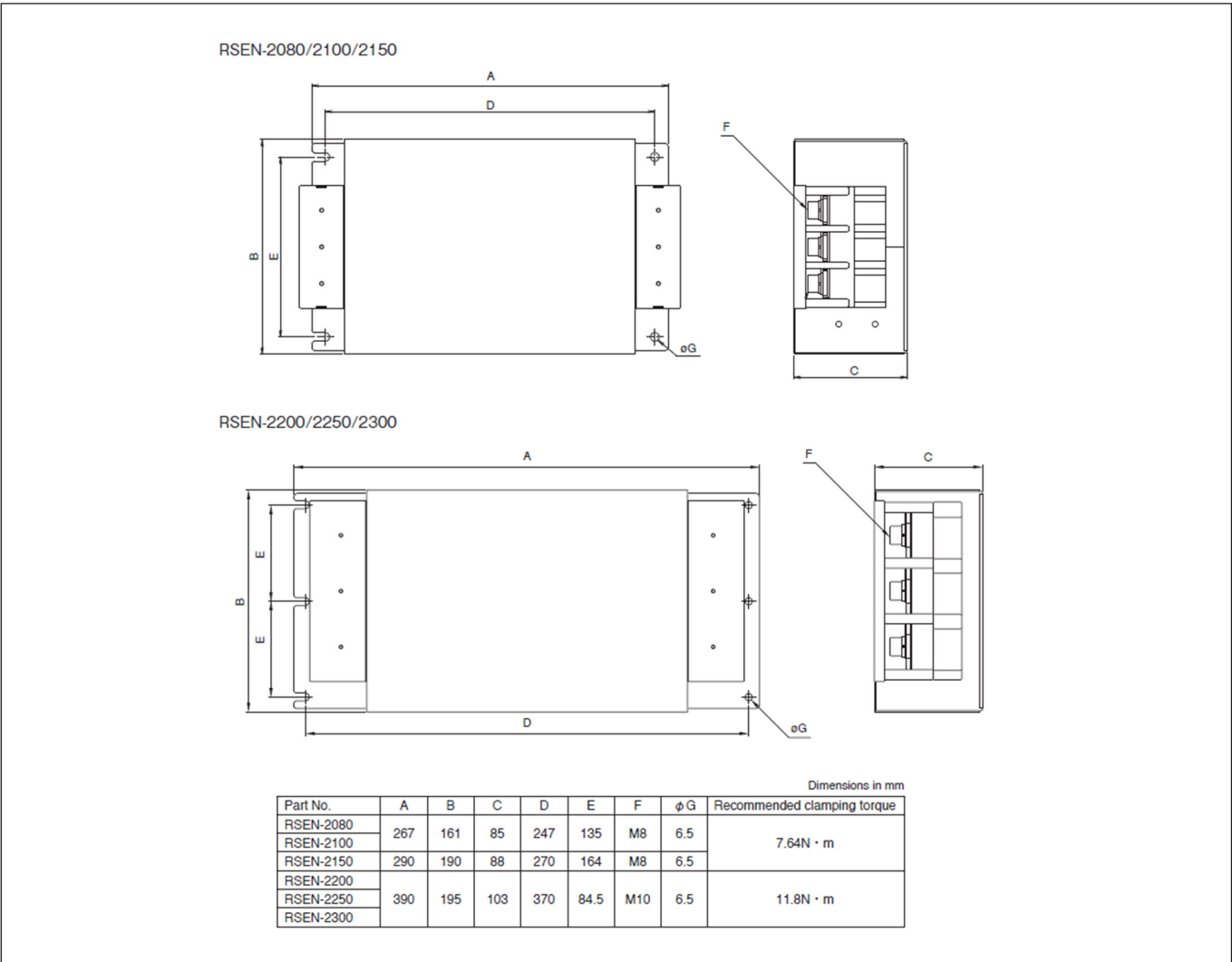

RSEN2xxxL Attenuation vs. Frequency

RSEN-2003L

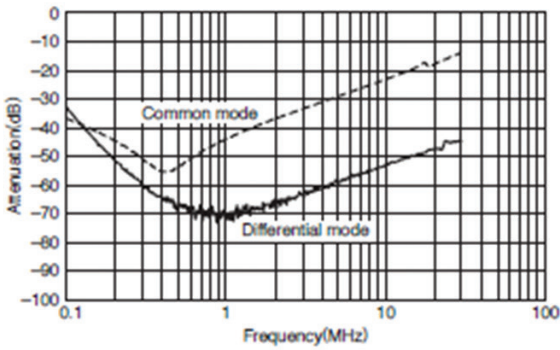

RSEN-2006L

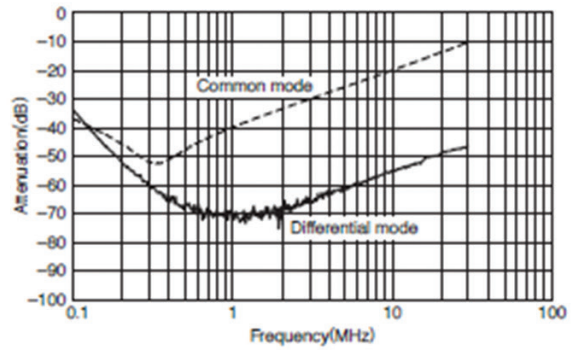

RSEN-2010L

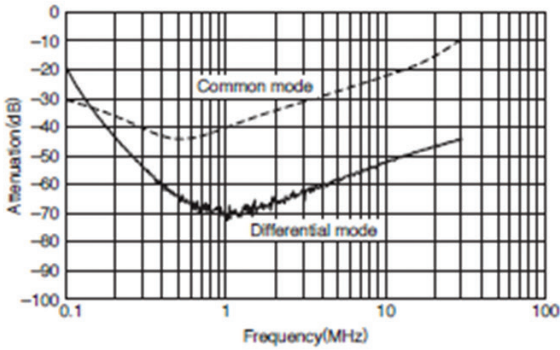

RSEN-2016L

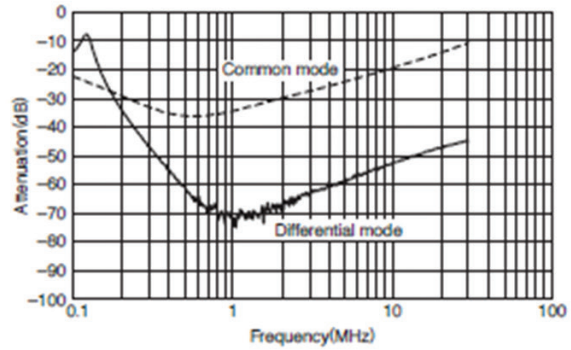

RSEN-2020L

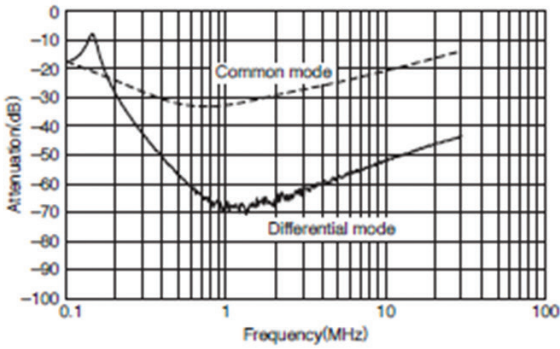

RSEN-2030L

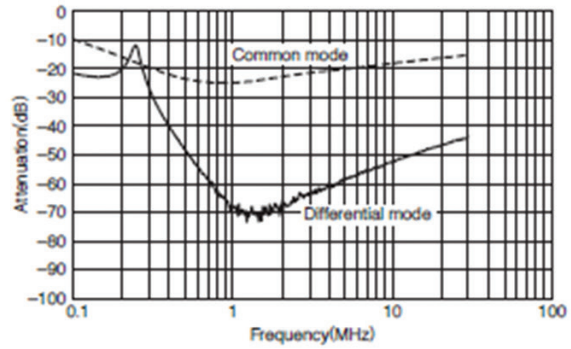



TDK-Lambda France SAS

Tel: +33 1 60 12 71 65
 tlf.fr-powersolutions@tdk.com
 www.emea.lambda.tdk.com/fr



Italy Sales Office

Tel: +39 02 61 29 38 63
 tlf.it-powersolutions@tdk.com
 www.emea.lambda.tdk.com/it



Netherlands

tlf.nl-powersolutions@tdk.com
 www.emea.lambda.tdk.com/nl



TDK-Lambda Germany GmbH

Tel: +49 7841 666 0
 tlq.powersolutions@tdk.com
 www.emea.lambda.tdk.com/de



Austria Sales Office

Tel: +43 2256 655 84
 tlq.at-powersolutions@tdk.com
 www.emea.lambda.tdk.com/at



Switzerland Sales Office

Tel: +41 44 850 53 53
 tlq.ch-powersolutions@tdk.com
 www.emea.lambda.tdk.com/ch



Nordic Sales Office

Tel: +45 8853 8086
 tlq.dk-powersolutions@tdk.com
 www.emea.lambda.tdk.com/dk



TDK-Lambda UK Ltd.

Tel: +44 (0) 12 71 85 66 66
 tlu.powersolutions@tdk.com
 www.emea.lambda.tdk.com/uk



TDK-Lambda Ltd.

Tel: +9 723 902 4333
 tli.powersolutions@tdk.com
 www.emea.lambda.tdk.com/il-en



TDK-Lambda Americas

Tel: +1 800-LAMBDA-4 or 1-800-526-2324
 tla.powersolutions@tdk.com
 www.us.lambda.tdk.com



TDK Electronics do Brasil Ltda

Tel: +55 11 3289-9599
 sales.br@tdk-electronics.tdk.com
 www.tdk-electronics.tdk.com/en



TDK-Lambda Corporation

Tel: +81-3-6778-1113
 www.jp.lambda.tdk.com



TDK-Lambda (China) Electronics Co. Ltd.

Tel: +86 21 6485-0777
 tlc.powersolutions@tdk.com
 www.lambda.tdk.com.cn



TDK-Lambda Singapore Pte Ltd.

Tel: +65 6251 7211
 tfs.marketing@tdk.com
 www.sg.lambda.tdk.com





TDK India Private Limited, Power Supply Division

Tel: +91 80 4039-0660
 mathew.philip@tdk.com
 www.sg.lambda.tdk.com







Looking for pricing, stock, or lifecycle information?

Click below to explore more details on WIN SOURCE:

-  [View RSEN-2020D on WIN SOURCE](#)
-  [TDK-Lambda Americas Inc. Information](#)

Optimize Your Supply Chain with WIN SOURCE Solutions

-  Global Sourcing Solution
-  Obsolete Management
-  Cost Control Management
-  Shortage Management
-  Alternative Solution
-  Excess Inventory Management