

### Features

Frequency range : 10MHz to 114MHz  
 Ceramic SMD package  
 Seam sealing  
 External dimensions (mm)  
 L : 3.2 x W : 2.5 x H : 0.7  
 RoHS compliant & Pb free

### Applications

Bluetooth, Wireless LAN  
 Cellular phone, Pager, DSC  
 Display, TV  
 Computer peripherals  
 Consumer products

### Electrical Characteristics

Item		7M	Conditions
Frequency Range	$F_0$	10MHz ~ 114MHz	
Frequency Tolerance	$F_{tol}$	±30ppm, ±20ppm, ±10ppm	at 25°C
Frequency Stability over Operating Temperature Range (refer to 25°C)	$F_{stab}$	±30 ppm	-20°C ~ +70°C
		±20 ppm	
		±10 ppm	
		±10 ppm	-30°C ~ +85°C
		±30 ppm	
		±20 ppm	
		±15 ppm	
±60 ppm	-40°C ~ +125°C		
Operating Temperature Range	$T_{OTR}$	-20°C ~ +70°C	
		-40°C ~ +85°C	
		-40°C ~ +125°C	
Shunt Capacitance	$C_0$	3pF Max.	
Drive Level	$D_L$	1 ~ 200µW (100µW Typ.)	
Load Capacitance	$C_L$	6pF, 7pF, 8pF, 9pF, 10pF 12pF, 16pF, 18pF, 20pF	
Aging (at 25°C ± 3°C, first year)	$F_{aging}$	±3ppm Max.	Note [1]
Storage Temperature Range	$T_{STR}$	-40°C ~ +85°C	

**Notes:**

[1] Please contact us for low aging +/-1ppm grade crystals.

### Motional Resistance (ESR)

Fundamental	
10 ~ 12 MHz	150Ω Max.
12 ~ 16 MHz	80Ω Max.
16 ~ 20 MHz	60Ω Max.
20 ~ 64 MHz	50Ω Max.

3rd Overtone	
60 ~ 80 MHz	80Ω Max.
80 ~ 114 MHz	60Ω Max.

## Dimensions

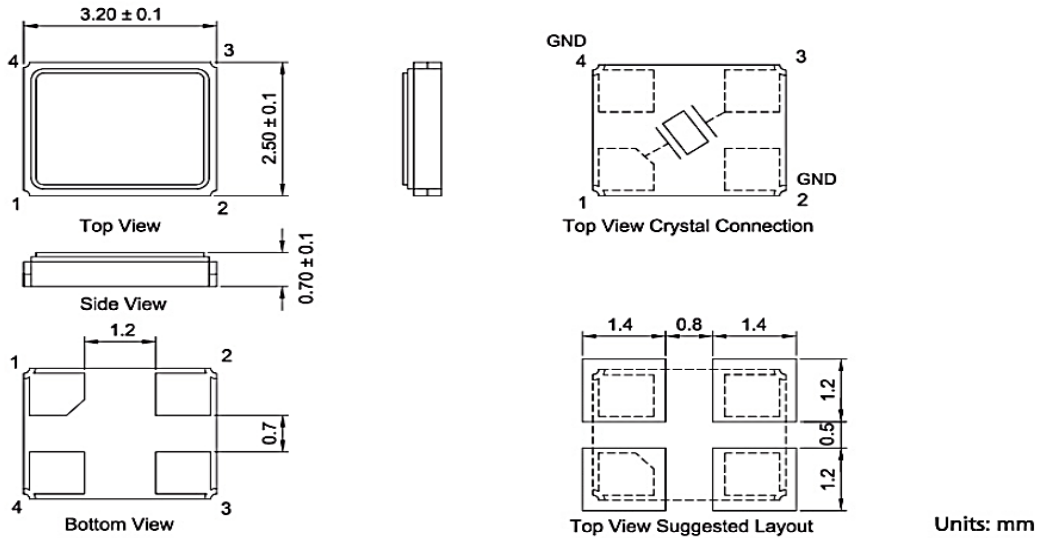

## Ordering Information

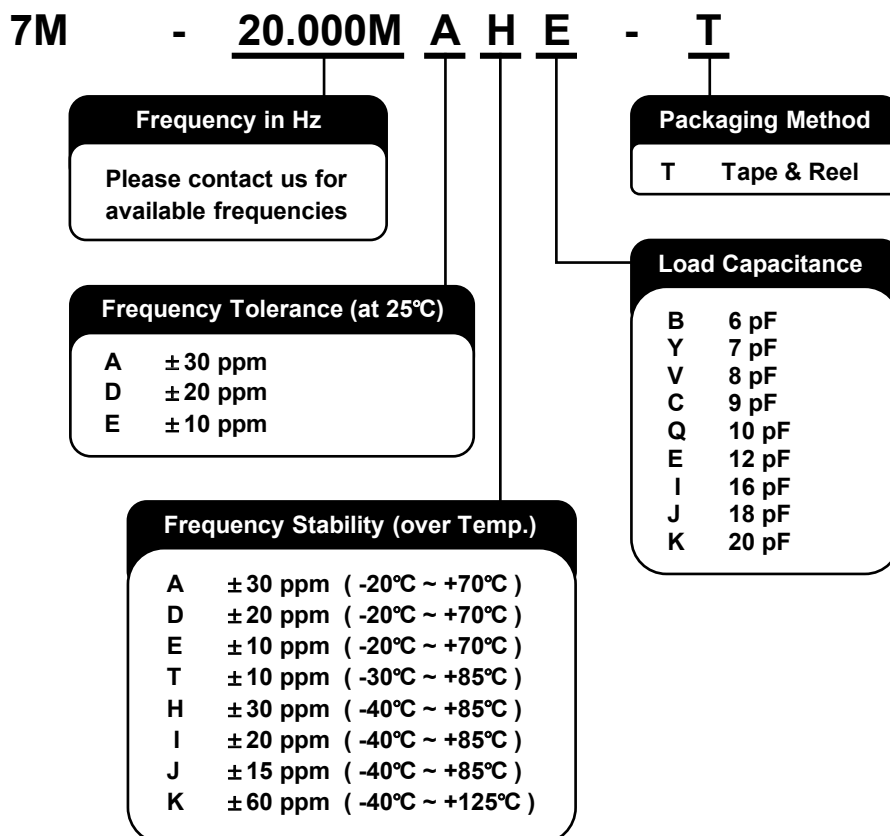

### Packing

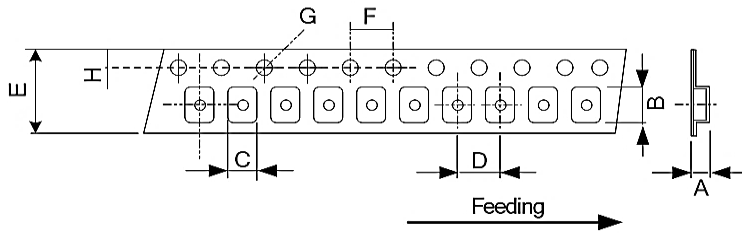

DIMENSIONS	A	B	C	D	E	F	G	H
	1.65	3.40	2.70	4.00	8.00	4.00	1.55	1.75
	±0.10	±0.10	±0.10	±0.10	±0.20	±0.10	±0.05	±0.10

(Unit: mm)

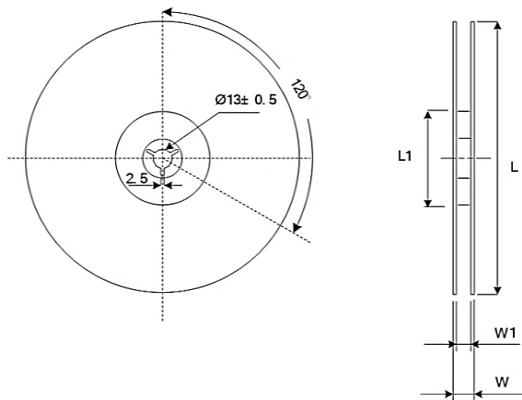

DIMENSIONS	L	L1	W	W1
	178	60.2	11.5	8
	±1.00	±0.50	±0.2	±0.1

(Unit: mm)

### Reflow Profile

Solder melting point : 220°C ± 10°C, 60 sec. Min.

Peak temperature : 260°C ± 10°C, 10 sec. Min.

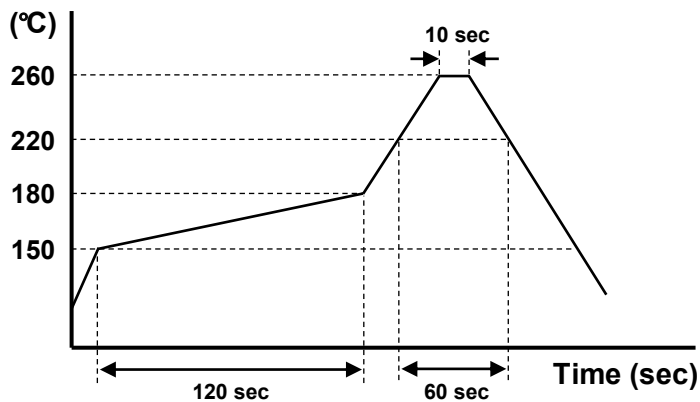



## Looking for pricing, stock, or lifecycle information?

Click below to explore more details on WIN SOURCE:

 [View 7M50072001](#) on WIN SOURCE

 [TXC CORPORATION](#) Information

## Optimize Your Supply Chain with WIN SOURCE Solutions

-  Global Sourcing Solution
-  Obsolete Management
-  Cost Control Management
-  Shortage Management
-  Alternative Solution
-  Excess Inventory Management