

10 MHz to 8 GHz Bypass Amplifier

FEATURES

- ▶ Small signal gain of 12.5 dB typical from 10 MHz to 500 MHz
- ▶ Broad operation from 10 MHz to 8000 MHz
- ▶ OIP3 of 34 dBm typical from 10 MHz to 500 MHz
- ▶ Internal amplifier state, output P1dB of 17 dBm typical from 5000 MHz to 8000 MHz
- ▶ Noise figure of 2.8 dB typical from 10 MHz to 500 MHz
- ▶ Low insertion loss of 2 dB typical for the internal bypass switch state from 10 MHz to 500 MHz
- ▶ Wide operating temperature range of -40°C to +85°C
- ▶ RoHS compliant, 6 mm × 6 mm, 28-terminal LGA
- ▶ ESD rating of ±750 V (Class 1B)

APPLICATIONS

- ▶ Military
- ▶ Test instrumentation
- ▶ Communications

FUNCTIONAL BLOCK DIAGRAM

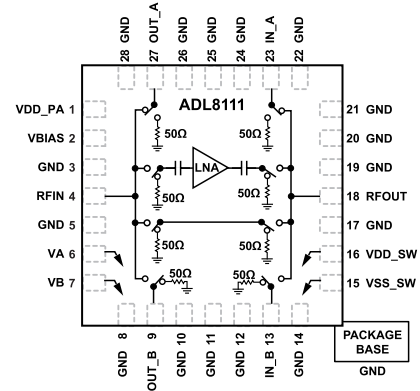

Figure 1.

GENERAL DESCRIPTION

The ADL8111 is a low noise amplifier (LNA) with a nonreflective bypass switch that provides broadband operation from 10 MHz to 8000 MHz. The ADL8111 provides a low noise figure of 2.8 dB with a high output third-order intercept (OIP3) of 34 dBm simultaneously, which delivers a high dynamic range. The ADL8111 provides a gain of 12.5 dB that is stable over frequency, temperature, power supply, and from device to device.

The integration of an amplifier and two single-pole, quad-throw (SP4T) nonreflective switches allows multiple gain and linearity values. The addition of switches also offers high input intercept performance and prevents distortion on the high signal level applications.

The ADL8111 has a high electrostatic discharge (ESD) rating of ±750 V (Class 1B) and is fully specified for operation across a wide temperature range of -40°C to +85°C. The ADL8111 is offered in a 6 mm × 6 mm, 28-terminal land grid array (LGA) package.

**TABLE OF CONTENTS**

Features.....	1	Internal Amplifier State.....	10
Applications.....	1	Internal Bypass State.....	14
Functional Block Diagram.....	1	External Bypass B State.....	16
General Description.....	1	Test Circuits.....	19
Specifications.....	3	Theory of Operation.....	20
Absolute Maximum Ratings.....	5	Signal Path States for Digital Control Inputs....	20
Thermal Resistance.....	5	Applications Information.....	21
Power Derating Curves.....	5	Recommended Bias Sequencing.....	21
ESD Caution.....	5	Evaluation PCB.....	22
Pin Configuration and Function Descriptions.....	6	Evaluation Board Schematic.....	23
Interface Schematics.....	6	Outline Dimensions.....	24
Typical Performance Characteristics.....	7	Ordering Guide.....	24
External Bypass A State.....	7	Evaluation Boards.....	24

**REVISION HISTORY****11/2021—Rev. 0 to Rev. A**

Changes to Figure 1.....	1
Added Figure 10; Renumbered Sequentially.....	6
Changes to Theory of Operation Section.....	20
Added Figure 84.....	21
Changes to Applications Information Section.....	21
Changes to Figure 86.....	23

**4/2019—Revision 0: Initial Version**

## SPECIFICATIONS

Drain bias voltage (VDD\_PA) = +5 V, quiescent drain supply current ( $I_{DQ\_PA}$ ) = 70 mA, negative bias voltage (VSS\_SW) = -3.3 V, positive bias voltage (VDD\_SW) = +3.3 V, and  $T_A$  = 25°C, unless otherwise noted.

Table 1.

Parameter	Test Conditions/Comments	Min	Typ	Max	Unit
<b>OVERALL FUNCTION</b>					
Frequency Range		10		5000	MHz
<b>INTERNAL AMPLIFIER STATE</b>					
Small Signal Gain		11.2	12.5		dB
Gain Flatness			±0.5		dB
Input Return Loss			24		dB
Output Return Loss			17		dB
Radio Frequency (RF) Settling Time					
	50% VA/VB to 0.5 dB margin of final RFOUT		170		ns
	50% VA/VB to 0.1 dB margin of final RFOUT		260		ns
Switching Speed					
Rise Time ( $t_{RISE}$ ) and Fall Time ( $t_{FALL}$ )	10% to 90% RFOUT		40		ns
Turn On Time ( $t_{ON}$ ) and Turn Off Time ( $t_{OFF}$ )	50% VA/VB to 90%/10% RF		160		ns
Output 1 dB Compression (P1dB)		17	19.5		dBm
Output Third-Order Intercept (OIP3)			34		dBm
Noise Figure			2.8		dB
VDD_PA		3.0	5.0	5.5	V
<b>INTERNAL BYPASS SWITCH STATE</b>					
Insertion Loss			2		dB
RF Settling Time					
	50% VA/VB to 0.5 dB margin of final RFOUT		175		ns
	50% VA/VB to 0.1 dB margin of final RFOUT		260		ns
Switching Speed					
$t_{RISE}/t_{FALL}$	10% to 90% RFOUT		60		ns
$t_{ON}/t_{OFF}$	50% VA/VB to 90%/10% RF		160		ns
Input Third-Order Intercept (IIP3)			58		dBm
0.5 dB Compression (P0.5dB)			34		dBm
P1dB			35		dBm
Return Loss On State			18		dB
Return Loss Off State			30		dB
VDD_SW		3.0	3.3	3.6	V
VSS_SW		-3.6	-3.3	-3.0	V
<b>EXTERNAL BYPASS A AND EXTERNAL BYPASS B STATES</b>					
Insertion Loss			1		dB
RF Settling Time					
	50% VA/VB to 0.5 dB margin of final RFOUT		180		ns
	50% VA/VB to 0.1 dB margin of final RFOUT		230		ns
Switching Speed					
$t_{RISE}/t_{FALL}$	10% to 90% RFOUT		70		ns
$t_{ON}/t_{OFF}$	50% VA/VB to 90%/10% RF		175		ns
IIP3			59		dBm
P0.5dB			35.5		dBm
P1dB			36		dBm
Return Loss On State			22		dB
Return Loss Off State			25		dB
VDD_SW		3.0	3.3	3.6	V

## SPECIFICATIONS

Table 1.

Parameter	Test Conditions/Comments	Min	Typ	Max	Unit
VSS_SW		-3.6	-3.3	-3.0	V

VDD\_PA = +5 V, I<sub>DQ\_PA</sub> = 70 mA, VSS\_SW = -3.3 V, VDD\_SW = +3.3 V, and T<sub>A</sub> = 25°C, unless otherwise noted.

Table 2.

Parameter	Test Conditions/Comments	Min	Typ	Max	Unit
OVERALL FUNCTION					
Frequency Range		5000		8000	MHz
INTERNAL AMPLIFIER STATE					
Small Signal Gain		10.6	11.5		dB
Gain Flatness			±1		dB
Input Return Loss			14		dB
Output Return Loss			16		dB
P1dB			17		dBm
OIP3			32		dBm
Noise Figure			4.5		dB
VDD_PA		3.0	5.0	5.5	V
INTERNAL BYPASS SWITCH STATE					
Insertion Loss			2.7		dB
IIP3 <sup>1</sup>			58		dBm
P0.5dB			34		dBm
Return Loss On State			18		dB
Return Loss Off State			22		dB
VDD_SW		3.0	3.3	3.6	V
VSS_SW		-3.6	-3.3	-3.0	V
EXTERNAL BYPASS A AND EXTERNAL BYPASS B STATES <sup>2</sup>					
Insertion Loss			1.5		dB
IIP3			57.5		dBm
P0.5dB			34.5		dBm
Return Loss On State			17		dB
Return Loss Off State			20		dB
VDD_SW		3.0	3.3	3.6	V
VSS_SW		-3.6	-3.3	-3.0	V

<sup>1</sup> IIP3 and compression data for the internal bypass and the External Bypass B states is the same as the External Bypass A state data.

<sup>2</sup> External Bypass A and External Bypass B were tested with an external 50 Ω transmission line on the evaluation board.

Table 3. Total Supply Current by V<sub>DD</sub>

Parameter	Min	Typ	Max	Unit
Supply Current				
VDD_PA = 5 V		70		mA
VDD_SW = +3.3 V		30		μA
VSS_SW = -3.3 V		30		μA

Table 4. Logic Control Voltage

Digital Control Inputs	Min	Typ	Max	Unit	Current
Low	0		0.8	V	<1 μA typical
High	1.4		VDD_SW + 0.3	V	<1 μA typical

## ABSOLUTE MAXIMUM RATINGS

Table 5.

Parameter	Rating
VDD_PA	+7 V dc
VDD_SW Range	-0.3 V to +3.7 V
VSS_SW Range	-3.7 V to +0.3 V
Control Voltage (VA, VB) Range	-0.3 V to VDD + 0.3 V
RF Input Power (RFIN) – Internal Amplifier State	20 dBm
RFIN – Internal Bypass, External Bypass A, External Bypass B	31 dBm
RFIN (IN_A, OUT_A, IN_B, and OUT_B) Termination Path (VDD_SW, VA, VB = 3.3 V, VSS = -3.3 V, T <sub>A</sub> = 85°C, and Frequency = 2 GHz)	28 dBm
Hot Switch Power Level (IN_A, OUT_A, IN_B, and OUT_B), VDD_SW = 3.3 V, T <sub>A</sub> = 85°C, and Frequency = 2 GHz	30 dBm
Hot Switch Power Level (Internal Amplifier State)	20 dBm
Continuous Power Dissipation, P <sub>DISS</sub> (T <sub>A</sub> = 85°C, Derate 6.8 mW/°C Above 85°C)	0.61 W
Channel Temperature	175°C
Maximum Peak Reflow Temperature (Moisture Sensitivity Level 3, MSL3) <sup>1</sup>	260°C
Storage Temperature Range	-40°C to +125°C
Operating Temperature Range	-40°C to +85°C
ESD Sensitivity (Human Body Model)	Class 1B (Passed ±750 V)

<sup>1</sup> See the [Ordering Guide](#) section for additional information.

Stresses at or above those listed under Absolute Maximum Ratings may cause permanent damage to the product. This is a stress rating only; functional operation of the product at these or any other conditions above those indicated in the operational section of this specification is not implied. Operation beyond the maximum operating conditions for extended periods may affect product reliability.

## THERMAL RESISTANCE

Thermal performance is directly linked to the printed circuit board (PCB) design and operating environment. Careful attention to PCB thermal design is required.

$\theta_{JC}$  is the junction to case thermal resistance.

Table 6. Thermal Resistance

Package Type	$\theta_{JC}$	Unit
CC-28-3 <sup>1</sup>	148	°C/W

<sup>1</sup>  $\theta_{JC}$  was determined by simulation under the following conditions: the heat transfer is due solely to thermal conduction from the channel through the ground paddle to the PCB, and the ground paddle is held constant at an 85°C operating temperature.

## POWER DERATING CURVES

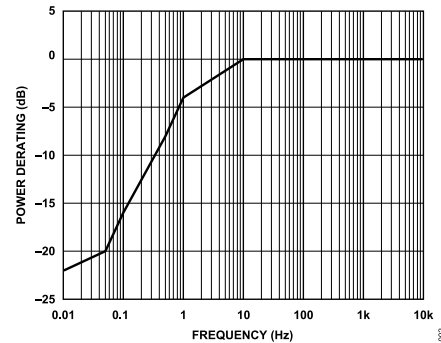

Figure 2. Power Derating for RFIN Port

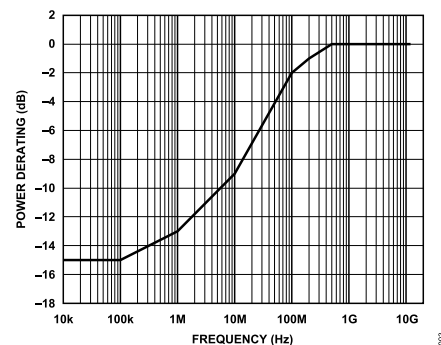

Figure 3. Power Derating for Terminated Path

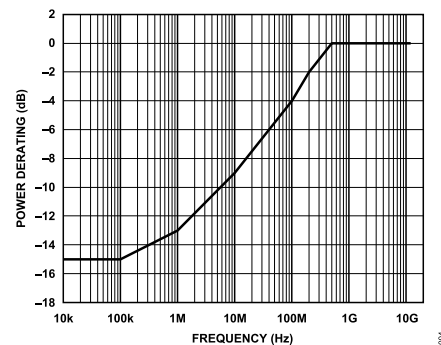

Figure 4. Power Derating for Hot Switching Power

## ESD CAUTION



**ESD (electrostatic discharge) sensitive device.** Charged devices and circuit boards can discharge without detection. Although this product features patented or proprietary protection circuitry, damage may occur on devices subjected to high energy ESD. Therefore, proper ESD precautions should be taken to avoid performance degradation or loss of functionality.

**PIN CONFIGURATION AND FUNCTION DESCRIPTIONS**

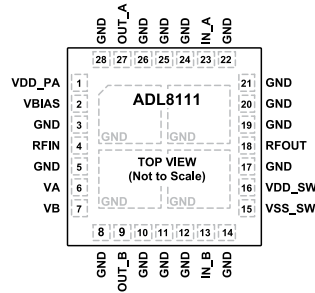

NOTES  
 1. EXPOSED PAD. THE EXPOSED PAD MUST BE CONNECTED TO RF AND DC GROUND.

**Figure 5. Pin Configuration—Top View Not to Scale**

**Table 7. Pin Function Descriptions**

Pin No.	Mnemonic	Description
1	VDD_PA	Drain Bias Voltage. See Table 2.
2	VBIAS	Current Mirror Bias Resistor Pin. Use this pin to set the current to the internal resistor by the external resistor. See Figure 9 for the interface schematic.
3, 5, 8, 10 to 12, 14, 17, 19 to 22, 24 to 26, 28	GND	RF and DC Ground. See Figure 6 for the interface schematic.
4	RFIN	RF Input. These pins are dc-coupled and matched to 50 Ω. A dc blocking capacitor is required if the RF line potential is not equal to 0 V dc.
6, 7	VA, VB	Control Input. See Table 2, Table 4, and Table 5. See Figure 8 and Figure 7 for the interface schematics.
9, 13	OUT_B, IN_B	These pins are dc-coupled and matched to 50 Ω. A dc blocking capacitor is required if the RF line potential is not equal to 0 V dc.
15	VSS_SW	Negative Bias Voltage. See Table 2.
16	VDD_SW	Positive Bias Voltage. See Table 2.
18	RFOUT	RF Output. This pin is dc-coupled and matched to 50 Ω. A dc blocking capacitor is required if the RF line potential is not equal to 0 V dc.
23, 27	IN_A, OUT_A	These pins are dc-coupled and matched to 50 Ω. A dc blocking capacitor is required if the RF line potential is not equal to 0 V dc.
	EPAD	Exposed Pad. The exposed pad must be connected to RF and dc ground.

**INTERFACE SCHEMATICS**



**Figure 6. GND Interface Schematic**

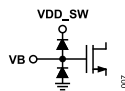

**Figure 7. VB Interface Schematic**

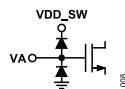

**Figure 8. VA Interface Schematic**

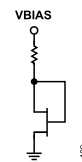

**Figure 9. VBIAS Interface Schematic**

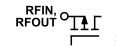

**Figure 10. RFIN and RFOUT Interface Schematic**

TYPICAL PERFORMANCE CHARACTERISTICS

EXTERNAL BYPASS A STATE

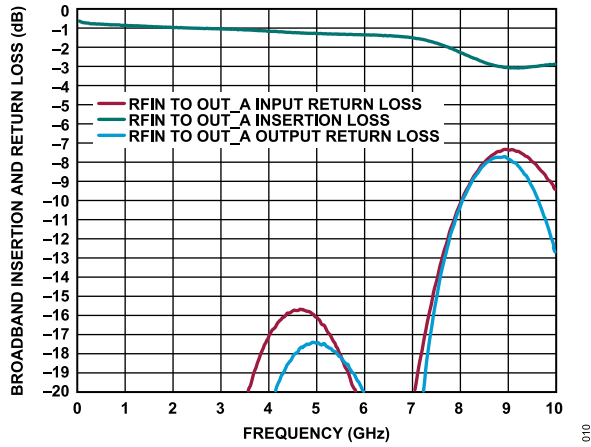

Figure 11. Broadband Insertion and Return Loss vs. Frequency, State = External Bypass A, Path = RFIN to OUT\_A (Refer to Figure 76 for the Test Circuit)

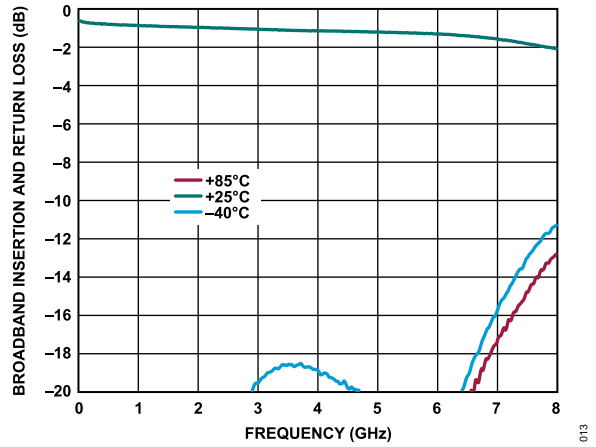

Figure 14. Broadband Insertion and Return Loss vs. Frequency, State = External Bypass A, Path = IN\_A to RFOUT (Refer to Figure 76 for the Test Circuit)

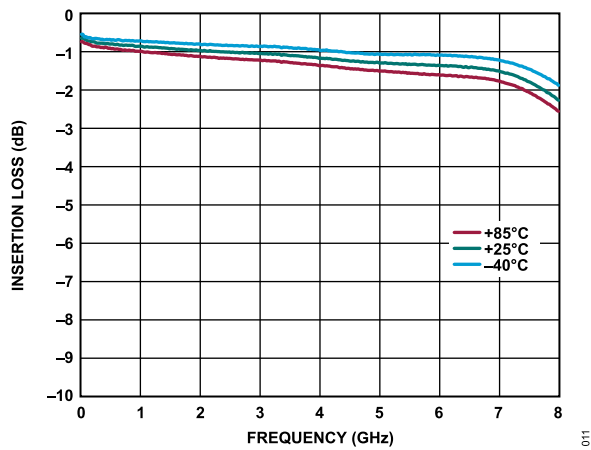

Figure 12. Insertion Loss Over Temperature vs. Frequency, State = External Bypass A, Path = RFIN to OUT\_A (Refer to Figure 76 for the Test Circuit)

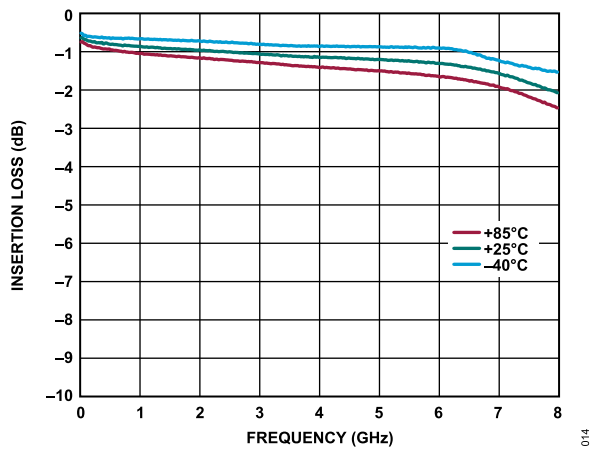

Figure 15. Insertion Loss Over Temperature vs. Frequency, State = External Bypass A, Path = IN\_A to RFOUT (Refer to Figure 76 for the Test Circuit)

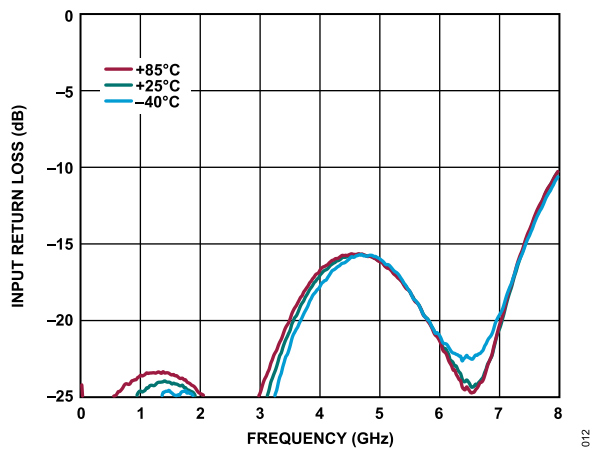

Figure 13. Input Return Loss Over Temperature vs. Frequency, State = External Bypass A, Path = RFIN to OUT\_A (Refer to Figure 76 for the Test Circuit)

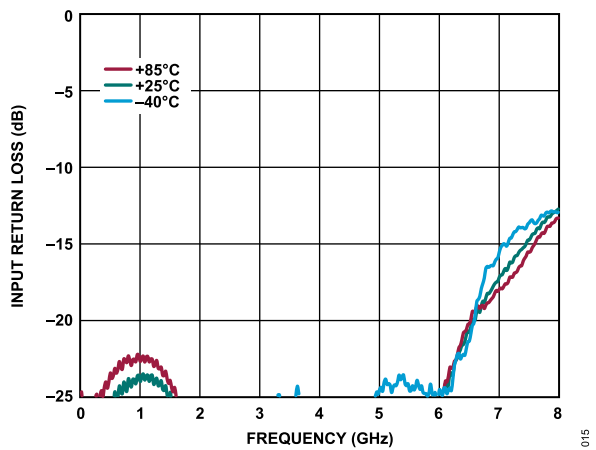

Figure 16. Input Return Loss Over Temperature vs. Frequency, State = External Bypass A, Path = IN\_A to RFOUT (Refer to Figure 76 for the Test Circuit)

TYPICAL PERFORMANCE CHARACTERISTICS

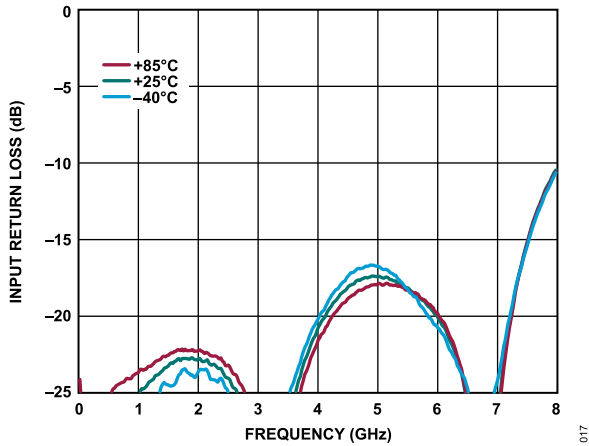

Figure 17. Input Return Loss Over Temperature vs. Frequency, State = External Bypass A, Path = RFIN to OUT\_A (Refer to Figure 76 for the Test Circuit)

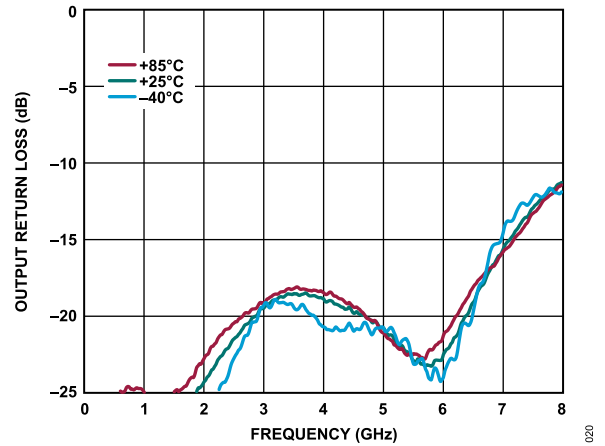

Figure 20. Output Return Loss Over Temperature vs. Frequency, State = External Bypass A, Path = IN\_A to RFOUT (Refer to Figure 76 for the Test Circuit)

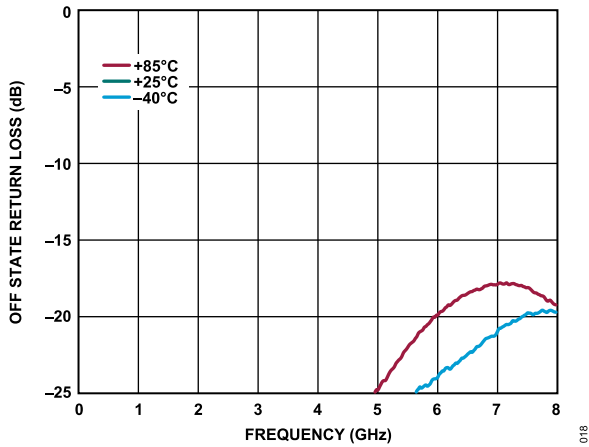

Figure 18. Off State Return Loss vs. Frequency Over Temperature, State = External Bypass A, Path = OUT\_B (Refer to Figure 76 for the Test Circuit)

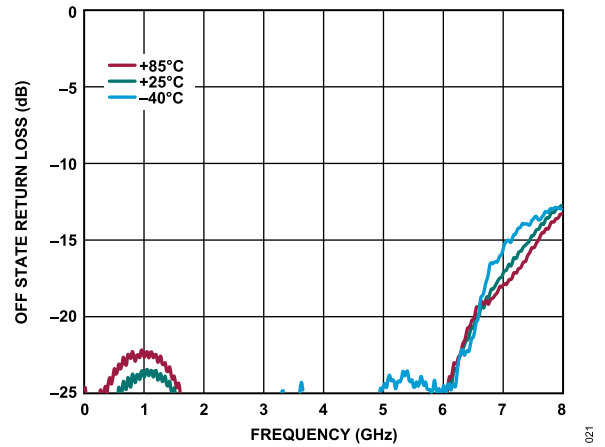

Figure 21. Off State Return Loss vs. Frequency Over Temperature, State = External Bypass A, Path = IN\_B (Refer to Figure 76 for the Test Circuit)

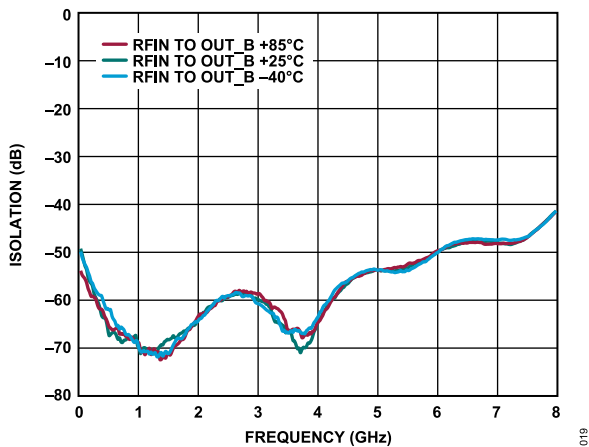

Figure 19. Isolation vs. Frequency Over Temperature, State = External Bypass A (Refer to Figure 76 for the Test Circuit)

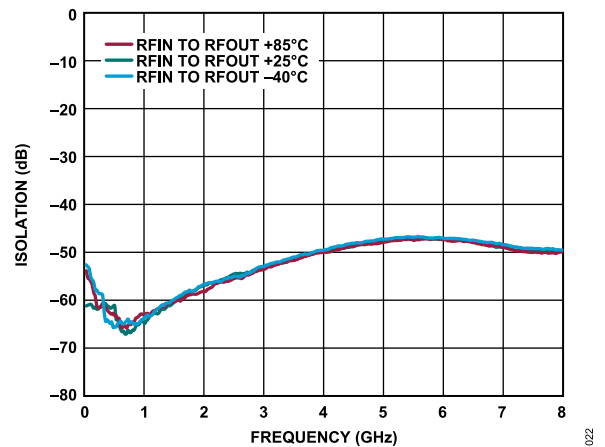

Figure 22. Isolation vs. Frequency Over Temperature, State = External Bypass A (Refer to Figure 76 for the Test Circuit)

TYPICAL PERFORMANCE CHARACTERISTICS

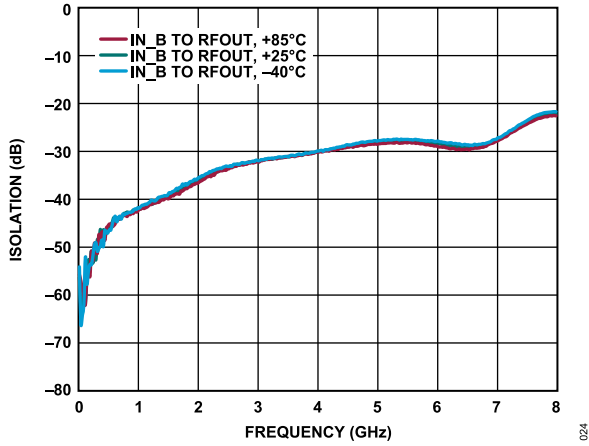

Figure 23. Isolation vs. Frequency Over Temperature, State = External Bypass A (Refer to Figure 76 for the Test Circuit)

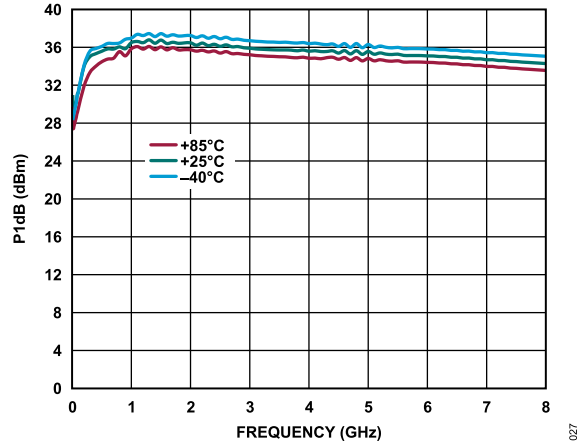

Figure 26. P1dB Compression vs. Frequency Over Temperature, State = External Bypass A, Path = RFIN to OUT\_A or IN\_A to RFOUT (Refer to Figure 76 for the Test Circuit)

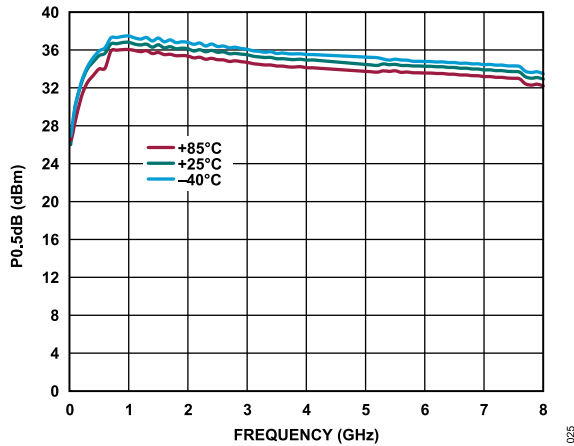

Figure 24. P0.5dB vs. Frequency Over Temperature, State = External Bypass A, Path = RFIN to OUT\_A or IN\_A to RFOUT (Refer to Figure 76 for the Test Circuit)

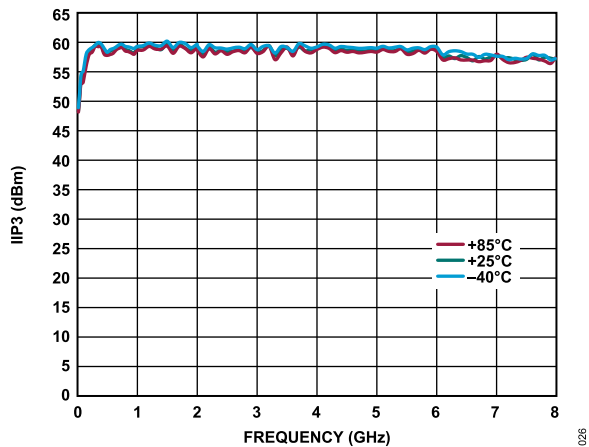

Figure 25. IIP3 vs. Frequency Over Temperature, State = External Bypass A, Path = RFIN to OUT\_A or IN\_A to RFOUT (Refer to Figure 76 for the Test Circuit)

TYPICAL PERFORMANCE CHARACTERISTICS

INTERNAL AMPLIFIER STATE

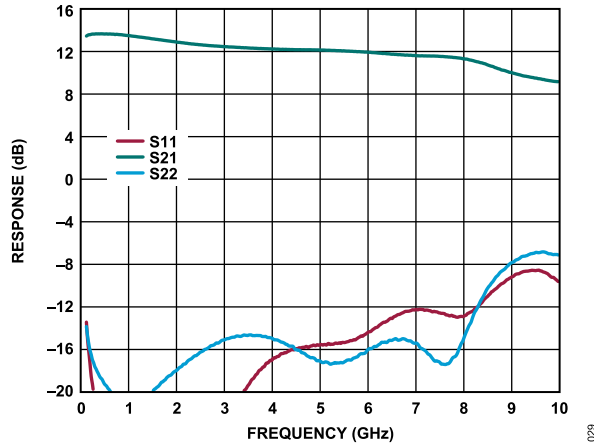

Figure 27. Broadband Gain and Return Loss vs. Frequency (100 MHz to 10 GHz), State = Internal Amplifier (Refer to Figure 77 for the Test Circuit)

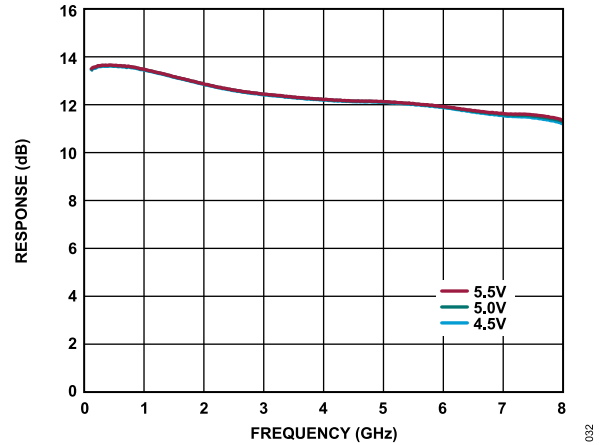

Figure 30. Gain vs Frequency Over VDD (100 MHz to 10 GHz), State = Internal Amplifier (Refer to Figure 77 for the Test Circuit)

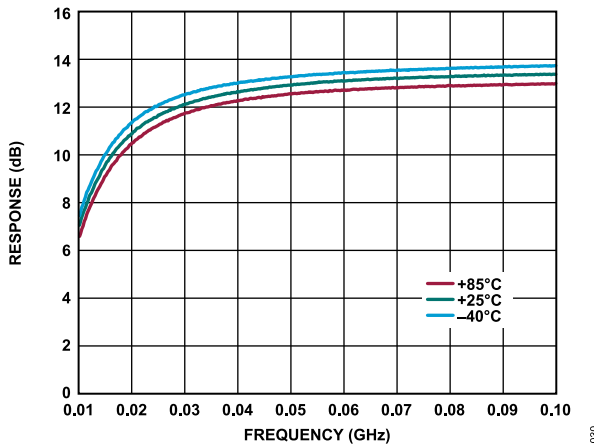

Figure 28. Gain Over Temperature vs. Frequency (10 MHz to 100 MHz) State = Internal Amplifier (Refer to Figure 77 for the Test Circuit)

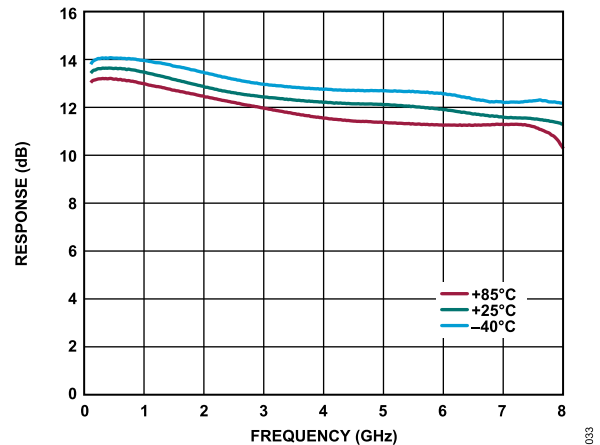

Figure 31. Gain vs. Frequency Over Temperature (100 MHz to 10 GHz) State = Internal Amplifier (Refer to Figure 77 for the Test Circuit)

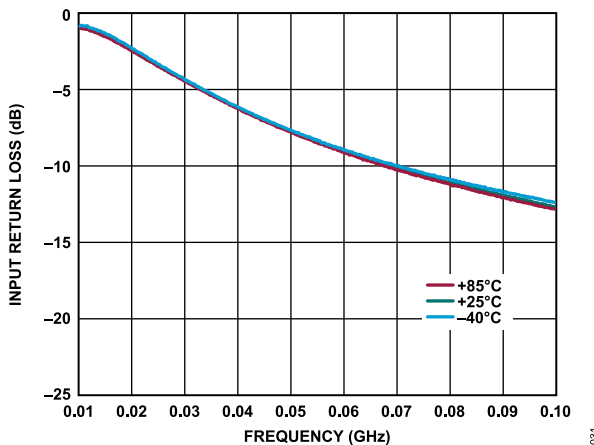

Figure 29. Input Return Loss vs. Frequency (10 MHz to 100 MHz), State = Internal Amplifier (Refer to Figure 77 for the Test Circuit)

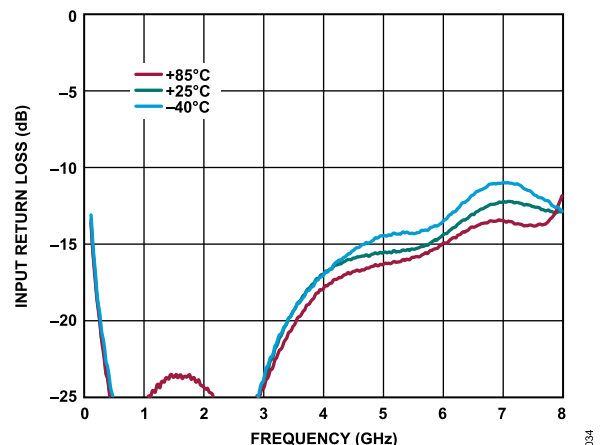

Figure 32. Input Return Loss vs. Frequency Over Temperature (100 MHz to 8 GHz), State = Internal Amplifier (Refer to Figure 77 for the Test Circuit)

TYPICAL PERFORMANCE CHARACTERISTICS

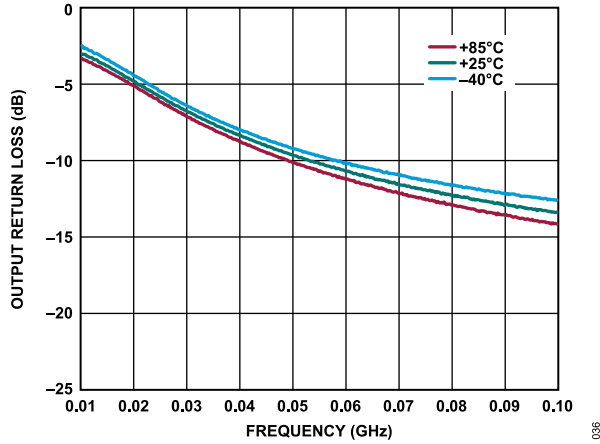

Figure 33. Output Return Loss vs. Frequency (10 MHz to 100 MHz), State = Internal Amplifier (Refer to Figure 77 for the Test Circuit)

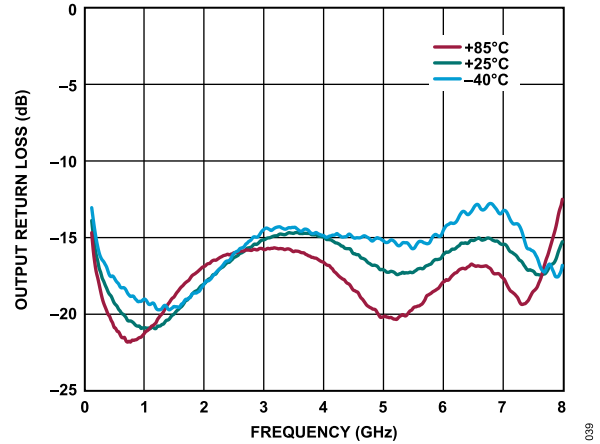

Figure 36. Output Return Loss vs. Frequency Over Temperature (100 MHz to 8 GHz), State = Internal Amplifier (Refer to Figure 77 for the Test Circuit)

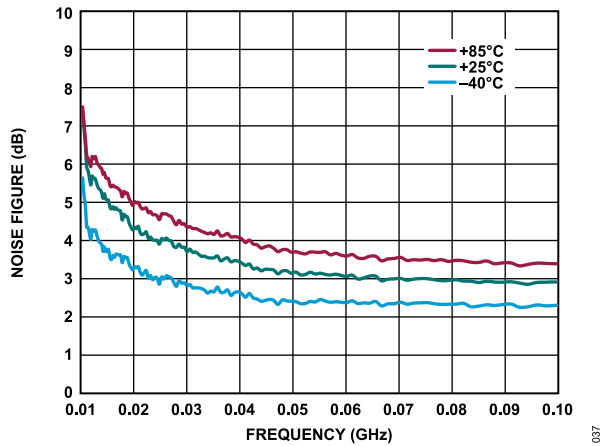

Figure 34. Noise Figure vs. Frequency Over Temperature (10 MHz to 100 MHz), State = Internal Amplifier (Refer to Figure 77 for the Test Circuit)

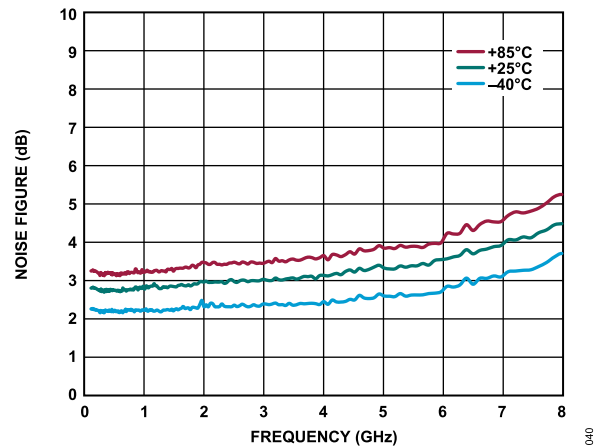

Figure 37. Noise Figure vs. Frequency Over Temperature (100 MHz to 8 GHz), State = Internal Amplifier (Refer to Figure 77 for the Test Circuit)

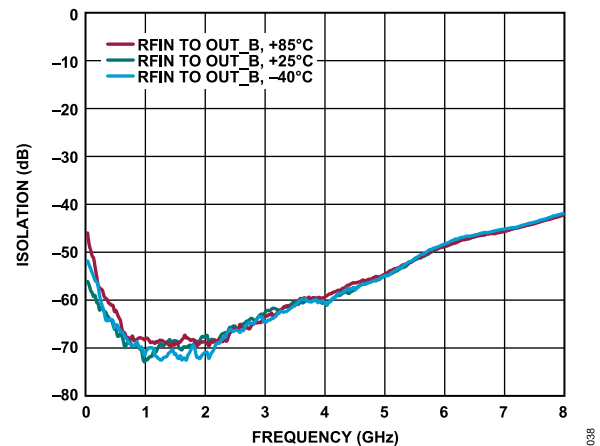

Figure 35. Isolation vs. Frequency Over Temperature, State = Internal Amplifier (Refer to Figure 77 for the Test Circuit)

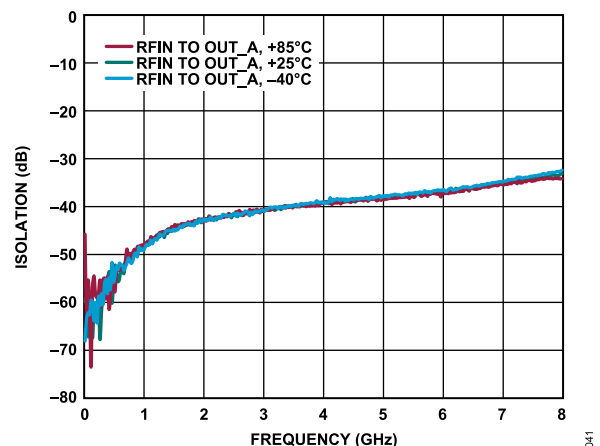

Figure 38. Isolation vs. Frequency Over Temperature (100 MHz to 8 GHz), State = Internal Amplifier (Refer to Figure 77 for the Test Circuit)

TYPICAL PERFORMANCE CHARACTERISTICS

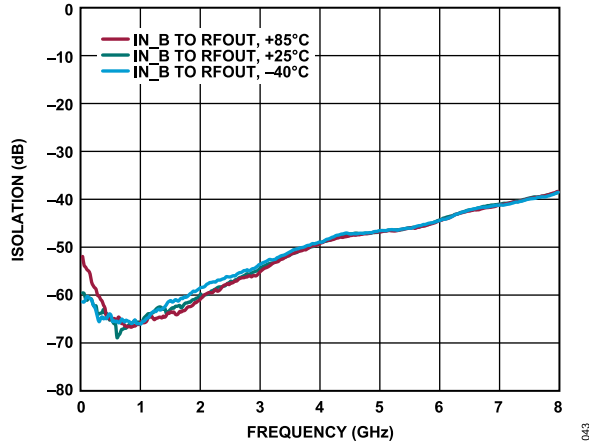

Figure 39. Isolation vs. Frequency Over Temperature (100 MHz to 8 GHz), State = Internal Amplifier (Refer to Figure 77 for the Test Circuit)

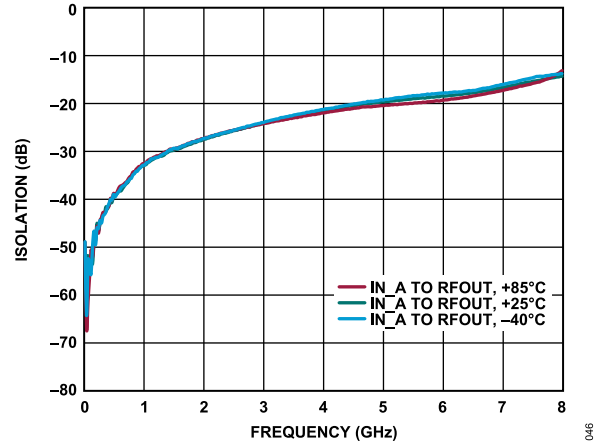

Figure 42. Isolation vs. Frequency Over Temperature (100 MHz to 8 GHz), State = Internal Amplifier (Refer to Figure 77 for the Test Circuit)

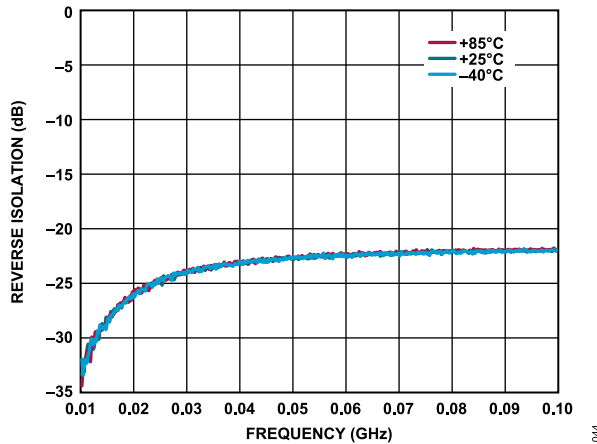

Figure 40. Reverse Isolation vs. Frequency Over Temperature (100 MHz to 8 GHz), State = Internal Amplifier (Refer to Figure 77 for the Test Circuit)

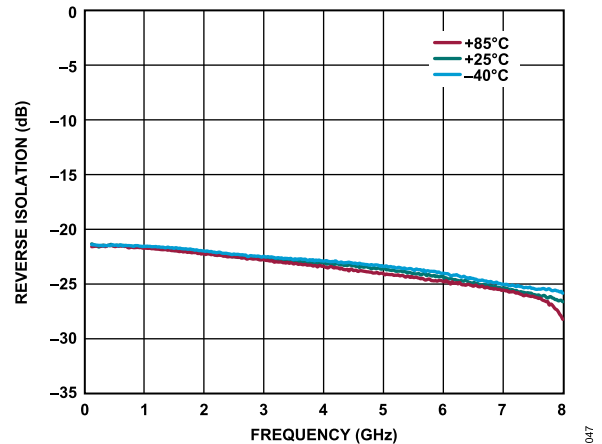

Figure 43. Reverse Isolation vs. Frequency Over Temperature (100 MHz to 8 GHz), State = Internal Amplifier (Refer to Figure 77 for the Test Circuit)

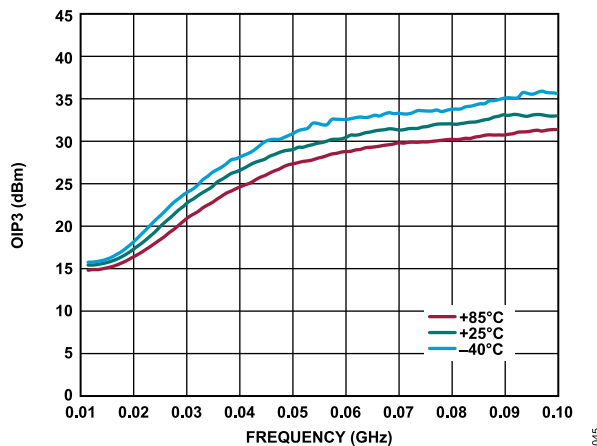

Figure 41. OIP3 vs. Frequency Over Temperature (10 MHz to 100 MHz), State = Internal Amplifier (Refer to Figure 77 for the Test Circuit)

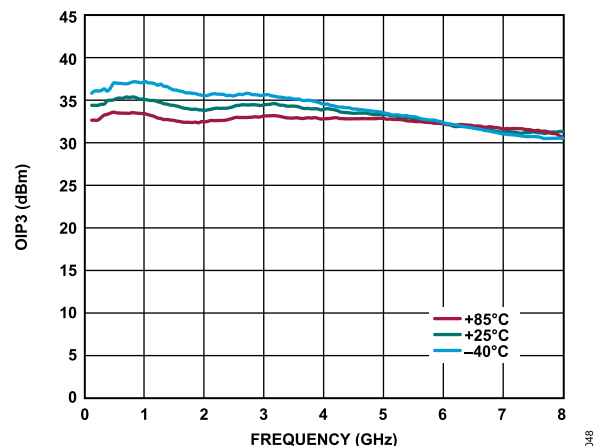

Figure 44. OIP3 vs. Frequency Over Temperature (100 MHz to 8 GHz), State = Internal Amplifier (Refer to Figure 77 for the Test Circuit)

TYPICAL PERFORMANCE CHARACTERISTICS

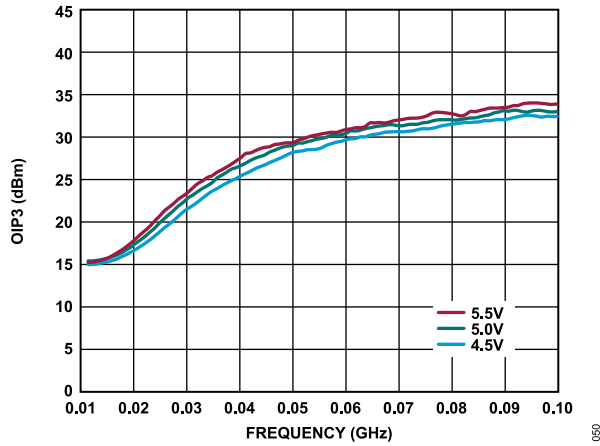

Figure 45. OIP3 vs. Frequency Over VDD (10 MHz to 100 MHz), State = Internal Amplifier (Refer to Figure 77 for the Test Circuit)

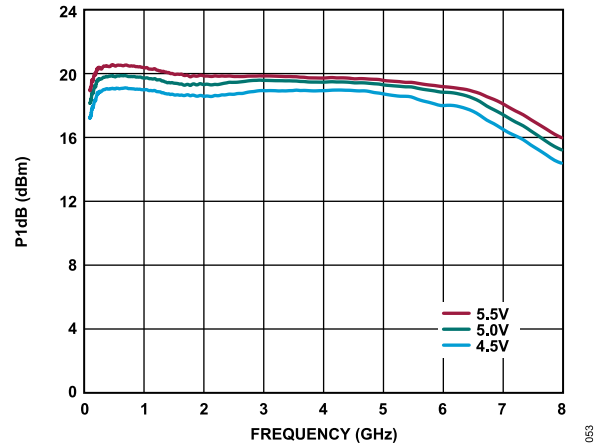

Figure 48. P1dB vs. Frequency Over VDD (100 MHz to 8 GHz), State = Internal Amplifier (Refer to Figure 77 for the Test Circuit)

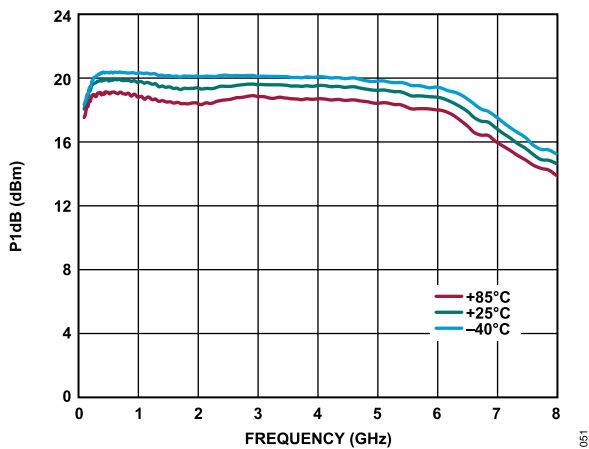

Figure 46. P1dB vs. Frequency Over Temperature (100 MHz to 8 GHz), State = Internal Amplifier (Refer to Figure 77 for the Test Circuit)

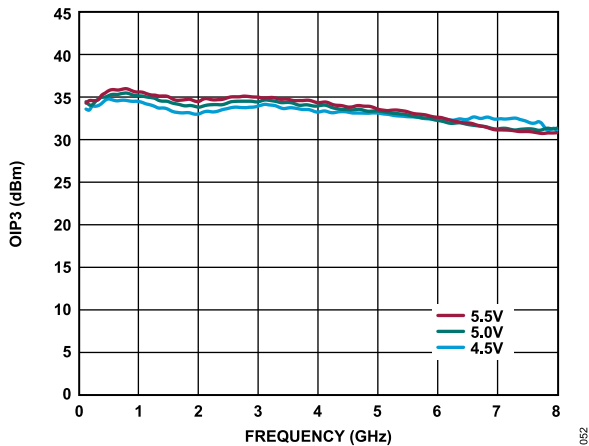

Figure 47. OIP3 vs. Frequency Over VDD (100 MHz to 8 GHz), State = Internal Amplifier (Refer to Figure 77 for the Test Circuit)

TYPICAL PERFORMANCE CHARACTERISTICS

INTERNAL BYPASS STATE

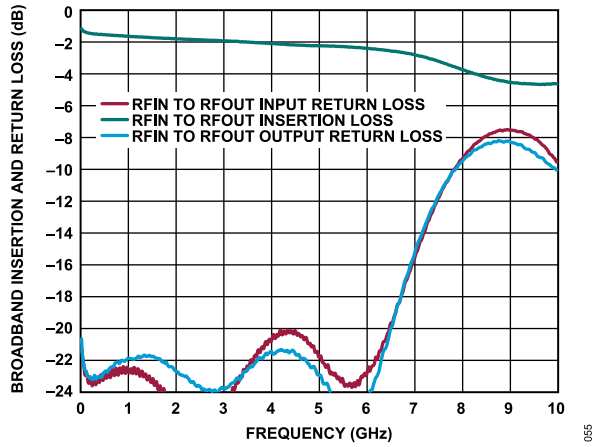

Figure 49. Broadband Insertion and Return Loss vs. Frequency, State = Internal Bypass (Refer to Figure 78 for the Test Circuit)

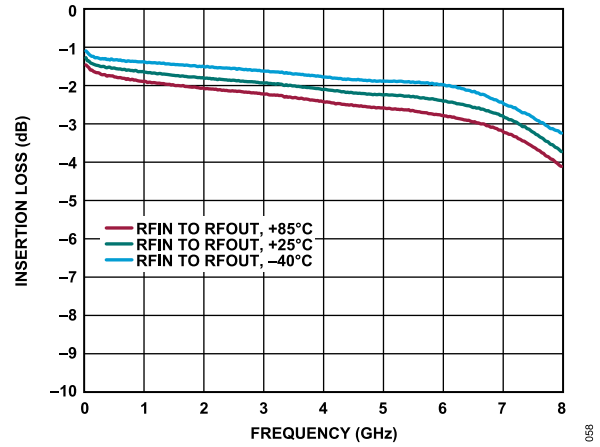

Figure 52. Insertion Loss Over Temperature vs. Frequency, State = Internal Bypass (Refer to Figure 78 for the Test Circuit)

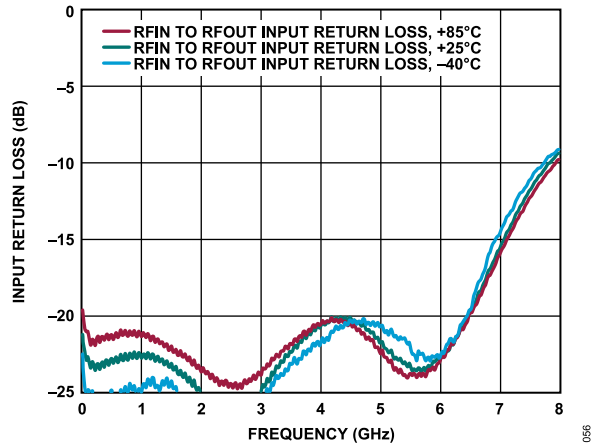

Figure 50. Input Return Loss Over Temperature vs. Frequency, State = Internal Bypass (Refer to Figure 78 for the Test Circuit)

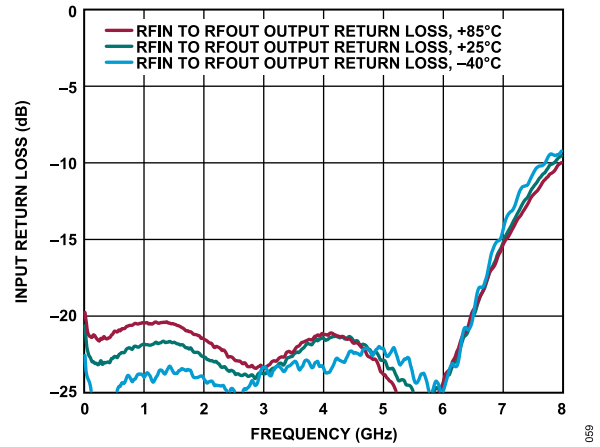

Figure 53. Output Return Loss Over Temperature vs. Frequency, State = Internal Bypass (Refer to Figure 78 for the Test Circuit)

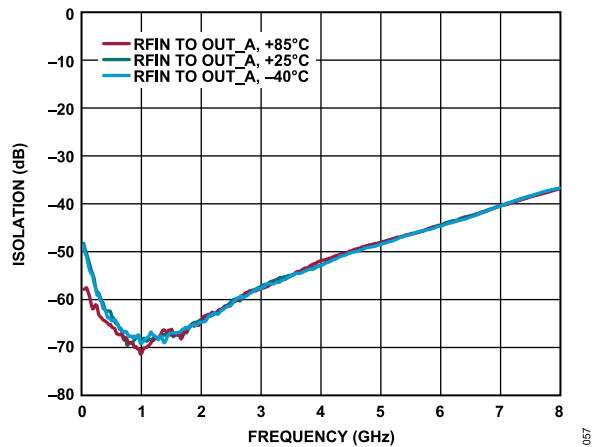

Figure 51. Isolation vs. Frequency Over Temperature, State = Internal Bypass (Refer to Figure 78 for the Test Circuit)

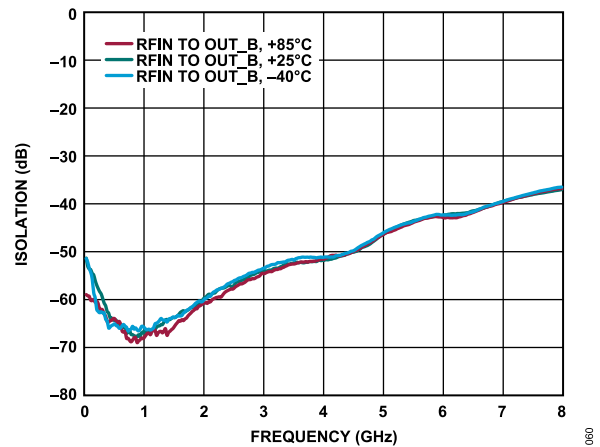

Figure 54. Isolation vs. Frequency Over Temperature, State = Internal Bypass (Refer to Figure 78 for the Test Circuit)

TYPICAL PERFORMANCE CHARACTERISTICS

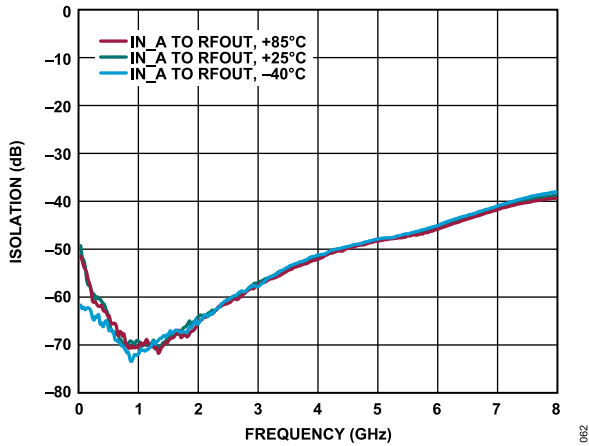

Figure 55. Isolation vs. Frequency Over Temperature, State = Internal Bypass (Refer to Figure 78 for the Test Circuit)

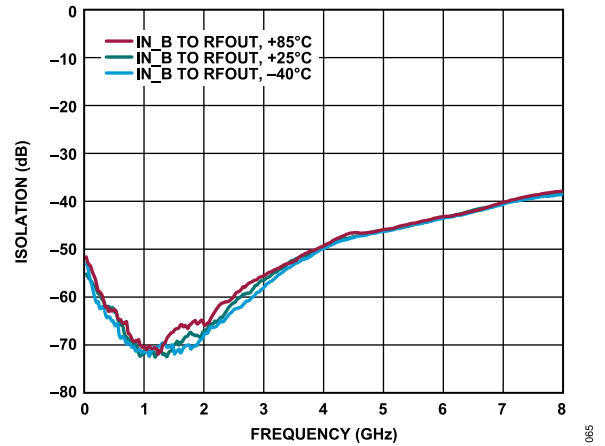

Figure 58. Isolation vs. Frequency Over Temperature, State = Internal Bypass (Refer to Figure 78 for the Test Circuit)

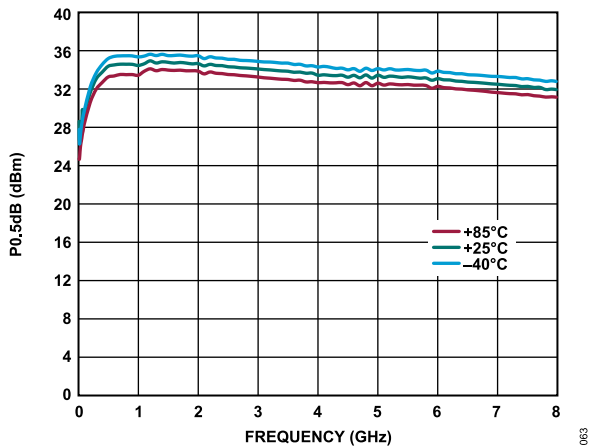

Figure 56. P0.5dB vs. Frequency Over Temperature, State = Internal Bypass, Path = RFIN to RFOUT (Refer to Figure 78 for the Test Circuit)

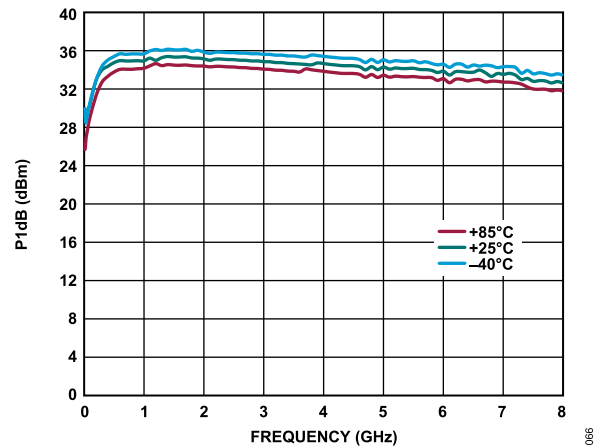

Figure 59. P1dB vs. Frequency Over Temperature, State = Internal Bypass, Path = RFIN to RFOUT (Refer to Figure 78 for the Test Circuit)

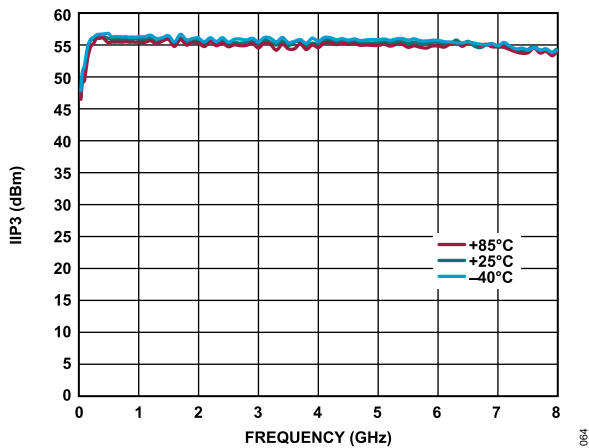

Figure 57. IIP3 vs. Frequency Over Temperature, State = Internal Bypass, Path = RFIN to RFOUT (Refer to Figure 78 for the Test Circuit)

TYPICAL PERFORMANCE CHARACTERISTICS

EXTERNAL BYPASS B STATE

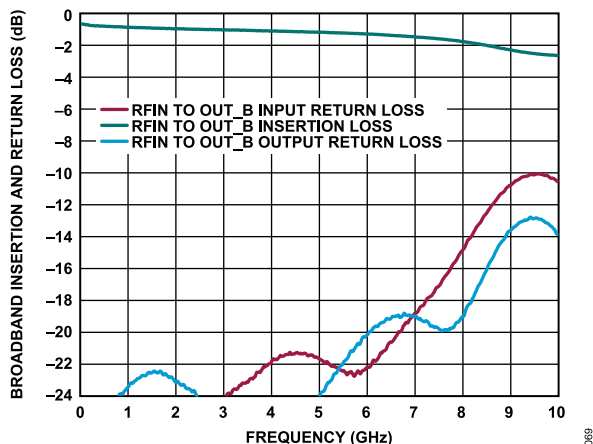

Figure 60. Broadband Insertion and Return Loss vs. Frequency, State = External Bypass B, Path = RFIN to OUT\_B (Refer to Figure 79 for the Test Circuit)

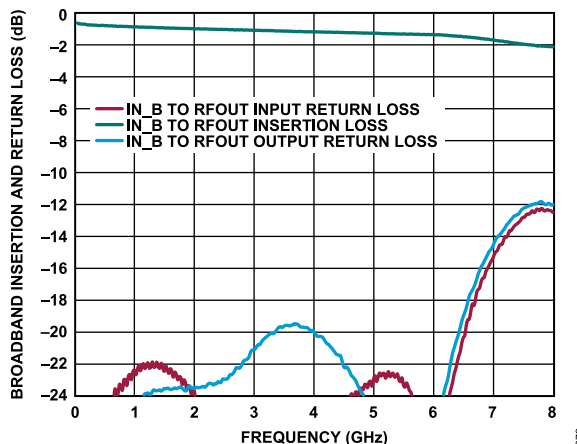

Figure 63. Broadband Insertion and Return Loss vs. Frequency, State = External Bypass B, Path = IN\_B to RFOUT (Refer to Figure 79 for the Test Circuit)

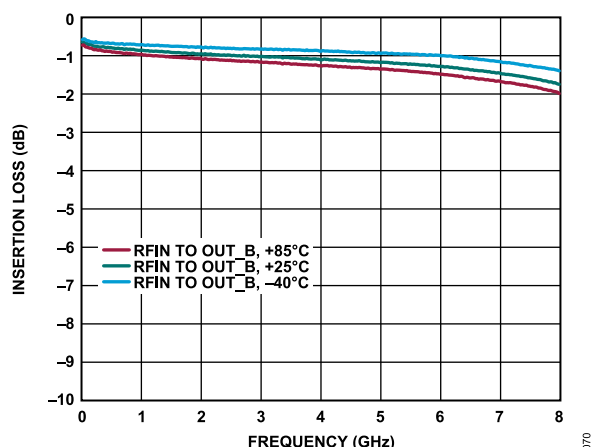

Figure 61. Insertion Loss Over Temperature vs. Frequency, State = External Bypass B, Path = RFIN to OUT\_B (Refer to Figure 79 for the Test Circuit)

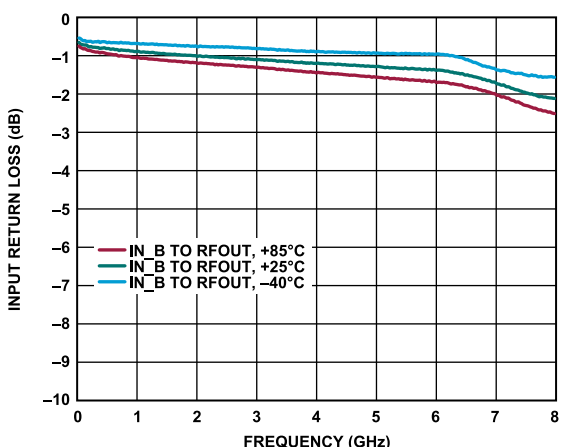

Figure 64. Insertion Loss Over Temperature vs. Frequency, State = External Bypass B, Path = IN\_B to RFOUT (Refer to Figure 79 for the Test Circuit)

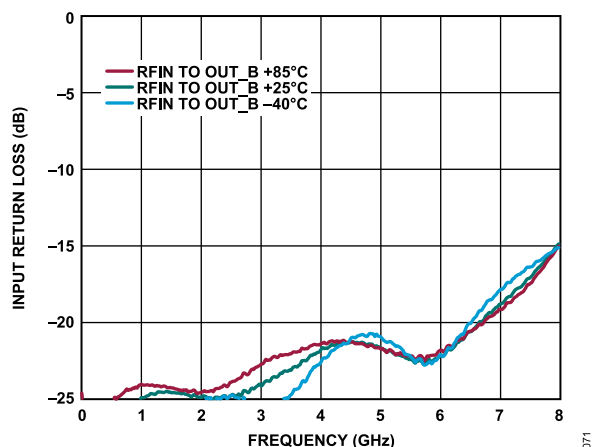

Figure 62. Input Return Loss Over Temperature vs. Frequency, State = External Bypass B, Path = RFIN to OUT\_B (Refer to Figure 79 for the Test Circuit)

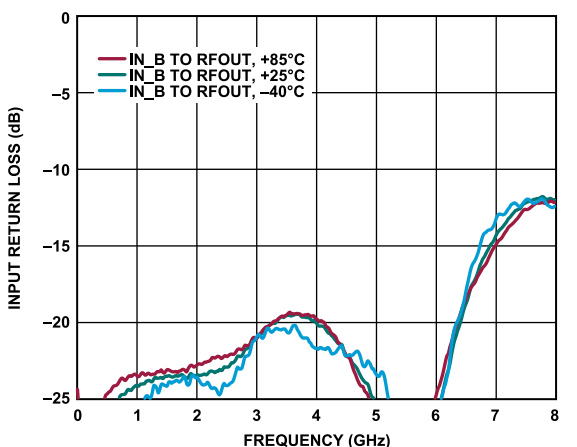

Figure 65. Input Return Loss Over Temperature vs. Frequency, State = External Bypass B, Path = IN\_B to RFOUT (Refer to Figure 79 for the Test Circuit)

TYPICAL PERFORMANCE CHARACTERISTICS

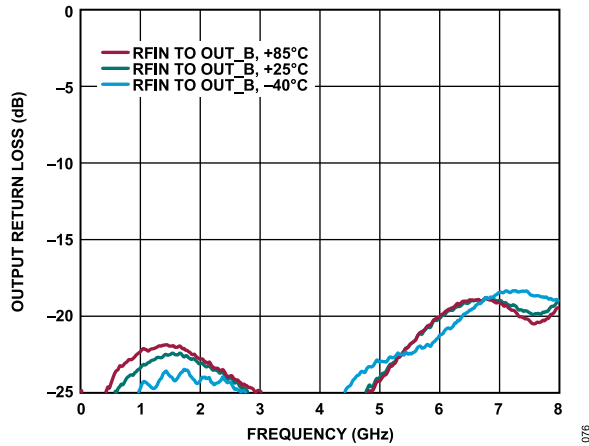

Figure 66. Output Return Loss Over Temperature vs. Frequency, State = External Bypass B, Path = RFIN to OUT\_B (Refer to Figure 79 for the Test Circuit)

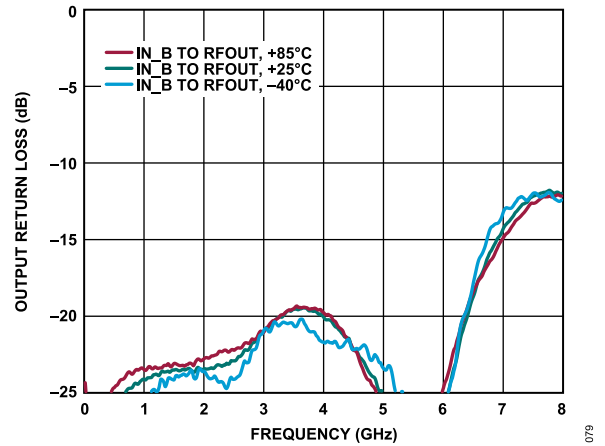

Figure 69. Output Return Loss Over Temperature vs. Frequency, State = External Bypass B, Path = IN\_B to RFOUT (Refer to Figure 79 for the Test Circuit)

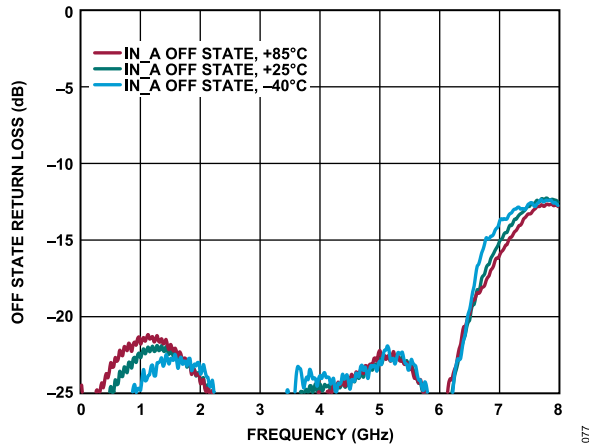

Figure 67. Off State Return Loss vs. Frequency Over Temperature, State = External Bypass B, Path = IN\_A (Refer to Figure 79 for the Test Circuit)

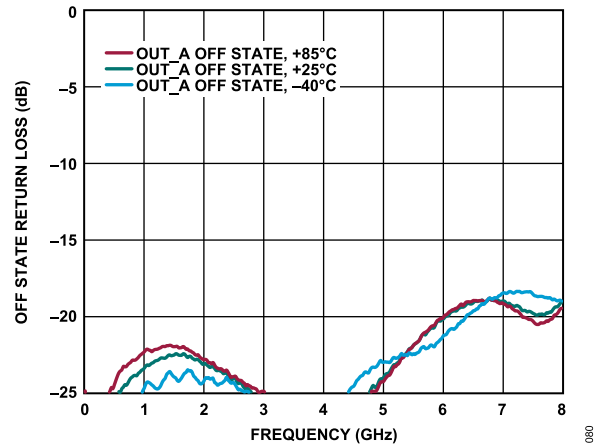

Figure 70. Off State Return Loss vs. Frequency Over Temperature, State = External Bypass B, Path = OUT\_A (Refer to Figure 79 for the Test Circuit)

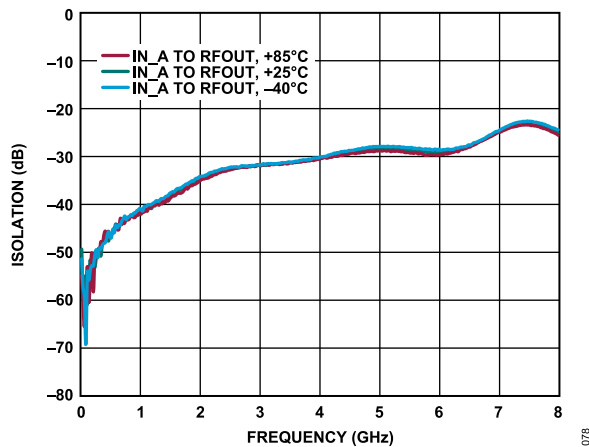

Figure 68. Isolation vs. Frequency Over Temperature, State = External Bypass B (Refer to Figure 79 for the Test Circuit)

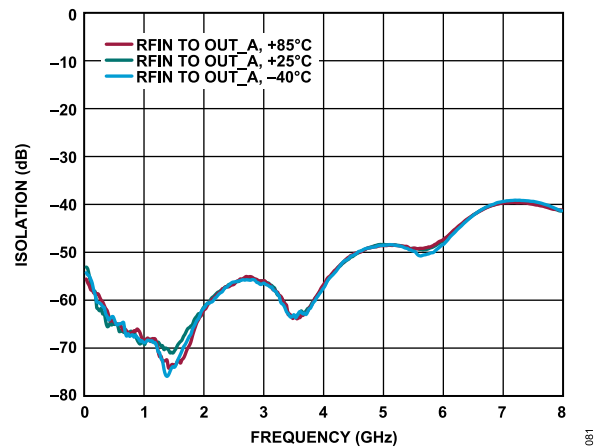

Figure 71. Isolation vs. Frequency Over Temperature, State = External Bypass B (Refer to Figure 79 for the Test Circuit)

TYPICAL PERFORMANCE CHARACTERISTICS

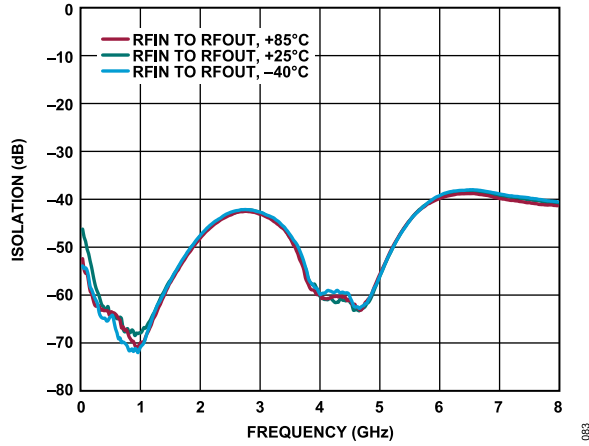

Figure 72. Isolation vs. Frequency Over Temperature, State = External Bypass B (Refer to Figure 79 for the Test Circuit)

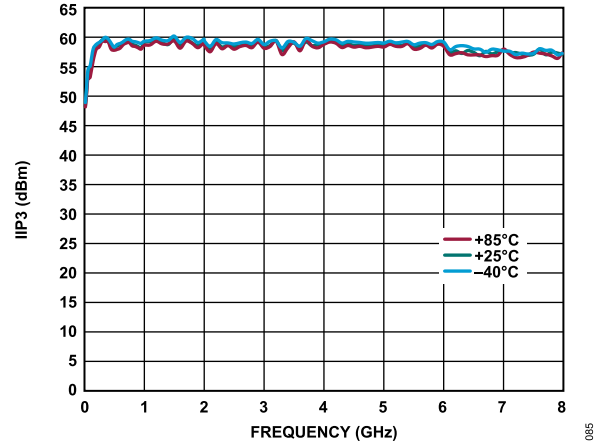

Figure 74. IIP3 vs. Frequency Over Temperature, State = External Bypass B, Path = RFIN to OUT\_B or IN\_B to RFOUT (Refer to Figure 79 for the Test Circuit)

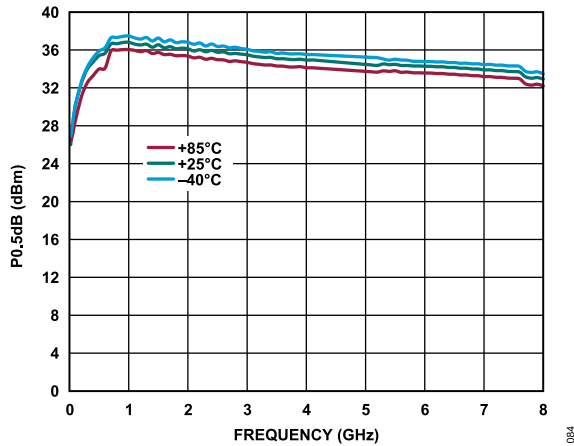

Figure 73. P0.5dB vs. Frequency Over Temperature, State = External Bypass B, Path = RFIN to OUT\_B or IN\_B to RFOUT (Refer to Figure 79 for the Test Circuit)

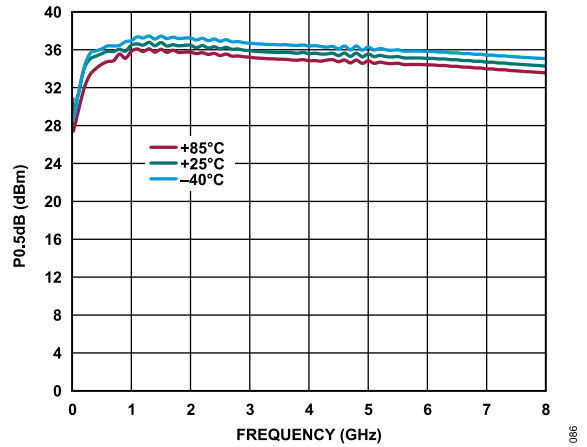

Figure 75. P0.5dB vs. Frequency Over Temperature, State = External Bypass B, Path = RFIN to OUT\_B or IN\_B to RFOUT (Refer to Figure 79 for the Test Circuit)

TEST CIRCUITS

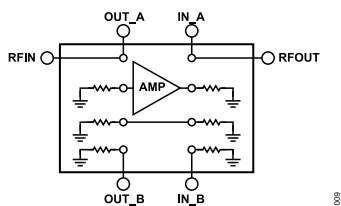

Figure 76. External Bypass A State

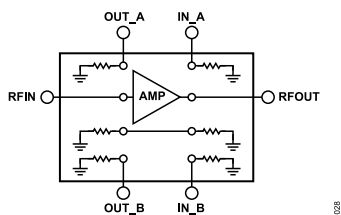

Figure 77. Internal Amplifier State

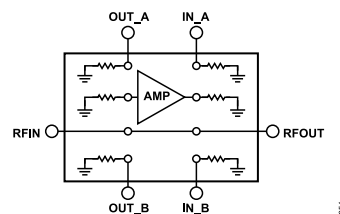

Figure 78. Internal Bypass State

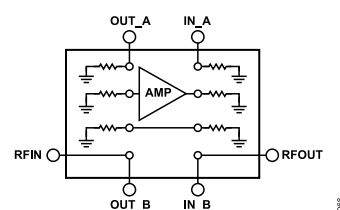

Figure 79. External Bypass B State

**THEORY OF OPERATION**

The ADL8111 integrates an amplifier with two switching networks located at the RF input and output. The amplifier, which is internally ac-coupled on its input and output, uses a gallium arsenide (GaAs) LNA die from the [HMC8411](#). The switching network employs robust silicon-on-insulator (SOI) technology for fast switching and a short settling time. This integrated solution has four different signal path states available: an internal amplifier, an internal bypass, External Bypass A, and External Bypass B. Signal path states are controlled through the digital pins, VA and VB, using 1.4 V high and 0 V low logic (see [Figure 80](#) to [Figure 83](#)). The internal amplifier is biased up by applying 5 V to VDD\_PA, and the internal switches are biased up by applying +3.3 V and -3.3 V to VDD\_SW and VSS\_SW, respectively. DC bias to the switches is independent of the LNA. Turning off bias to VDD\_PA to the LNA provides better isolation between RF ports.

**SIGNAL PATH STATES FOR DIGITAL CONTROL INPUTS**

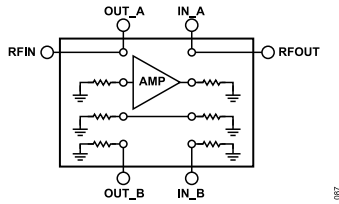

Figure 80. External Bypass A, VA = 0 V and VB = 0 V

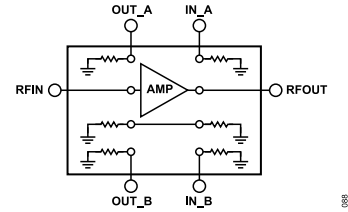

Figure 81. Internal Amplifier, VA = 0 V and VB = 3.3 V

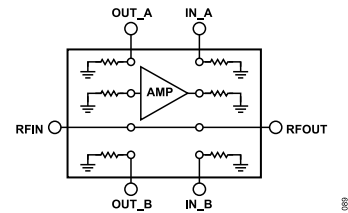

Figure 82. Internal Bypass, VA = 3.3 V and VB = 0 V

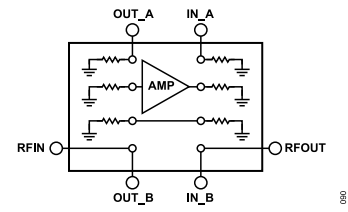

Figure 83. External Bypass B, VA = 3.3 V and VB = 3.3 V

Table 8. Truth Table

State Name	Digital Control Inputs		Signal Path State
	VA	VB	
External Bypass A	Low	Low	RFIN to OUT_A, IN_A to RFOUT
Internal Amplifier	Low	High	RFIN to RFOUT through amplifier path
Internal Bypass	High	Low	RFIN to RFOUT through bypass path
External Bypass B	High	High	RFIN to OUT_B, IN_B to RFOUT

## APPLICATIONS INFORMATION

The basic connections for operating the ADL8111 are shown in [Figure 86](#), which is also the schematic for the evaluation board. A 5 V dc bias is supplied to the amplifier on VDD\_PA, +3.3 V dc bias supply to VDD\_SW and -3.3 V dc bias supply to VSS\_SW.

VA and VB are digital inputs set path states shown in [Table 7](#). High logic state is set at 1.4 V and low logic state is set at 0 V.

The LNA within the ADL8111 operates in self-biased mode where the VBIAS pin is connected to a 560  $\Omega$  external resistor to achieve a 70 mA supply current. Refer to [Table 9](#) for the recommended resistor values to achieve different  $I_{DQ}$  currents.

[Figure 84](#) shows the time domain response at RFOUT to switching voltages on VA and VB when RFIN is driven by a steady level of approximately 2.5 dBm at 200 MHz. Both of the External Bypass connections paths (External Bypass A, External Bypass B) are left open.

With VA and VB low and high respectively, the ADL8111 is in Internal Amplifier Mode and the observed output level is approximately 4V<sub>pp</sub> or 16 dBm. With VA high and VB low, device switches to Internal Bypass Mode, and the output drops correspondingly. With VA and VB both low or both high, the device switches to either External Bypass A or External Bypass B. Since these two paths are left open in this case, no signal appears at the output for both cases.

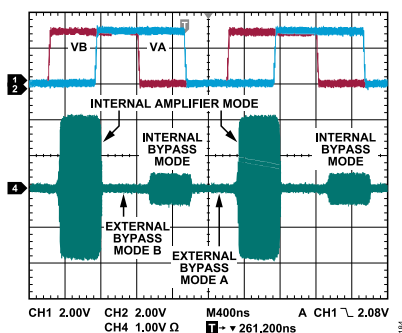

**Figure 84. Time Domain Response of RFOUT to Switching of VA and VB Voltages with a Continuous 2.5 dBm RF Input on RFIN**

## RECOMMENDED BIAS SEQUENCING

### During Power-Up

The recommended bias sequence during power-up follows:

1. Set VDD\_SW = 3.3 V.
2. Set VSS\_SW = -3.3 V.
3. Set VDD\_PA = 5 V.
4. Apply the RF signal.

### During Power-Down

The recommended bias sequence during power-down follows:

1. Turn off the RF signal.
2. Set VDD\_PA = 0 V.
3. Set VSS\_SW = 0 V.
4. Set VDD\_SW = 0 V.

The bias conditions, VDD\_PA = 5 V at  $I_{DQ} = 70$  mA, is the recommended operating point to achieve optimum performance. The data used in this data sheet was taken with the recommended bias condition. Using the [HMC8411](#) with different bias conditions can provide different performance than what is shown in the [Typical Performance Characteristics](#) section.

**Table 9. Recommended Bias Resistor Values at VDD\_PA = 5 V**

R <sub>BIAS</sub> ( $\Omega$ )	I <sub>DQ</sub> (mA)
226	85
560	70
1.1 k	55

**EVALUATION PCB**

The [ADL8111-EVALZ](#) is the evaluation board for the ADL8111 with fully populated components as shown in [Figure 85](#) and its schematic shown in [Figure 86](#). The board is fabricated with four layers using Rogers 4350. Signal lines have characteristic impedance of 50  $\Omega$ . Package ground leads and the exposed paddle are soldered to the ground plane. Adequate amounts of via holes connect the top and bottom ground planes. The evaluation board is available from Analog Devices, Inc., upon request. Gerber files can be found on the [ADL8111](#) product webpage.

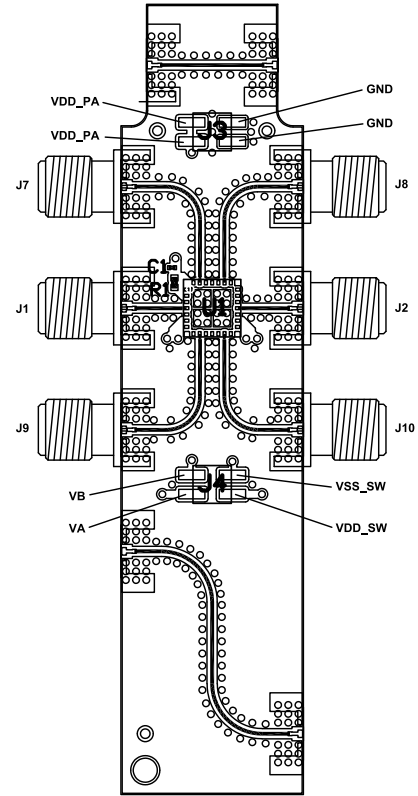

Figure 85. ADL8111-EVALZ Evaluation Board PCB

EVALUATION PCB

EVALUATION BOARD SCHEMATIC

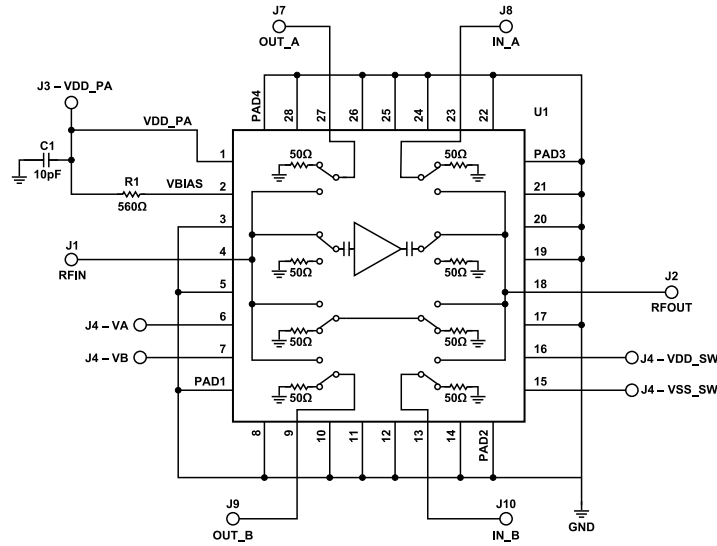
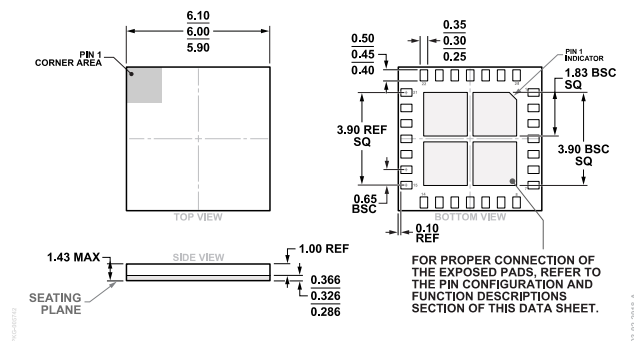

Figure 86. ADL8111-EVALZ Evaluation Board Schematic

Table 10. Bill of Material for Evaluation PCB ADL8111-EVALZ

Item	Description
J1, J2, J7, J8, J9, J10	SRI SMA RF connectors
J3, J4	DC header pins
U1	ADL8111
C1	10 pF, 5% tolerance, 0201, ceramic capacitor
R1	560 Ω, 1/16 W, 0402, thick film resistor

## OUTLINE DIMENSIONS



**Figure 87. 28-Terminal Land Grid Array [LGA]  
(CC-28-3)**  
Dimensions shown in millimeters

Updated: October 07, 2021

## ORDERING GUIDE

Model <sup>1, 2</sup>	Temperature Range	Package Description	Packing Quantity	Package Option
ADL8111ACCZN	-40°C to +85°C	28 ld LGA (6mm x 6mm w/4 EP)	Reel, 500	CC-28-3
ADL8111ACCZN-R7	-40°C to +85°C	28 ld LGA (6mm x 6mm w/4 EP)	Reel, 500	CC-28-3

<sup>1</sup> Z = RoHS Compliant Part.

<sup>2</sup> For the ADL8111ACCZN and ADL8111ACCZN-R7, the MSL rating is MSL3.

## EVALUATION BOARDS

Model <sup>1</sup>	Package Description
ADL8111-EVALZ	Evaluation Board

<sup>1</sup> Z = RoHS Compliant Part.

## Looking for pricing, stock, or lifecycle information?

Click below to explore more details on WIN SOURCE:

- ⊖ [View ADL8111ACCZN-R7 on WIN SOURCE](#)
- ⊖ [Analog Devices Inc. Information](#)

## Optimize Your Supply Chain with WIN SOURCE Solutions

- ✓ Global Sourcing Solution
- ✓ Obsolete Management
- ✓ Cost Control Management
- ✓ Shortage Management
- ✓ Alternative Solution
- ✓ Excess Inventory Management