

MMA-273334D-M5 27 – 33 GHz, 2.5W MMIC Power Amplifier

Features:

- Frequency Range: 27 – 33 GHz
- P1dB: 33 dBm
- IM3 Level: -25 dBc @ Po = 27 dBm/tone
- Gain: 26 dB
- Vdd = 6V
- Idsq = 1100 to 1800mA
- Input and Output Fully Matched to 50 Ω
- Output Power Detector

Applications:

- Point-to-Point Radio
- VSAT

Functional Block Diagram

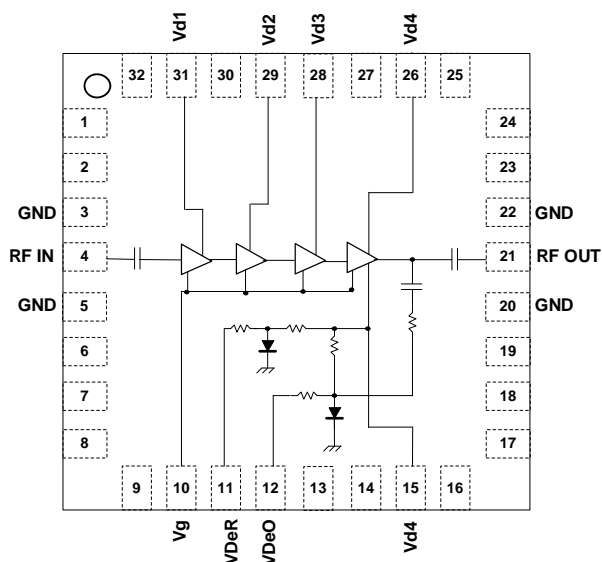

Description:

The MMA-273334D-M5 is a 2.5W GaAs pHEMT MMIC power amplifier in a compact 5 mm QFN surface mount package. The MMA-273334D-M5 provides 33dBm of output power (P-1dB) and 26dB of small-signal gain from 27GHz to 33GHz.

Absolute Maximum Ratings: (Ta= 25 °C)*

SYMBOL	PARAMETERS	UNITS	Min.	Max.
Vd	Drain Voltage	V		6.5
Vg	Gate Voltage	V	-2.1	0
Ig	Gate Current	mA	-17	17
Pd	Power Dissipation	W		24
Pin max	RF Input Power	dBm		20
Tch	Channel Temperature	°C		+150
Tstg	Storage Temperature	°C		-55 to +150
Tmax	Max. Assembly Temp (20 sec max)	°C		+250

*Operation of this device above any one of these parameters may cause permanent damage.

MMA-273334D-M5

27 – 33 GHz, 2.5W MMIC Power Amplifier

Electrical Specifications: $V_d = 6V$, $I_{dq} = 1600mA$, $T_a = 25\text{ }^\circ\text{C}$, $Z_o = 50\text{ ohm}$

Parameter	Units	Typical Data
Frequency Range	GHz	27-33
Gain	dB	26
Gain Flatness	+/-dB	2
Input Return Loss	dB	10
Output Return Loss	dB	10
VdeR	V	0.89
VdeO @29.5GHz, @ Po = +20dBm	V	0.85
@ Po = +33dBm	V	0.0
Output P1dB	dBm	33
Output P3dB	dBm	34
IM3 Level ⁽¹⁾	dBc	-25
Thermal Resistance	$^\circ\text{C}/\text{W}$	5.3
Total Drain Current at P1dB	mA	1600

(1) Output IP3 is measured with two tones at output power of 27 dBm/tone separated by 20 MHz.

Typical RF Performance: $V_d = 6V$, $I_{dq} = 1600mA$, $V_g = -0.85V$ typical, $Z_o = 50\text{ ohm}$

Small Signal Gain vs. Frequency

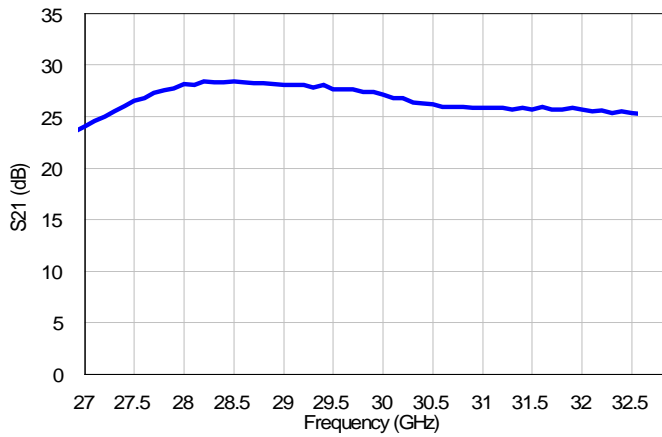

Input Return Loss vs. Frequency

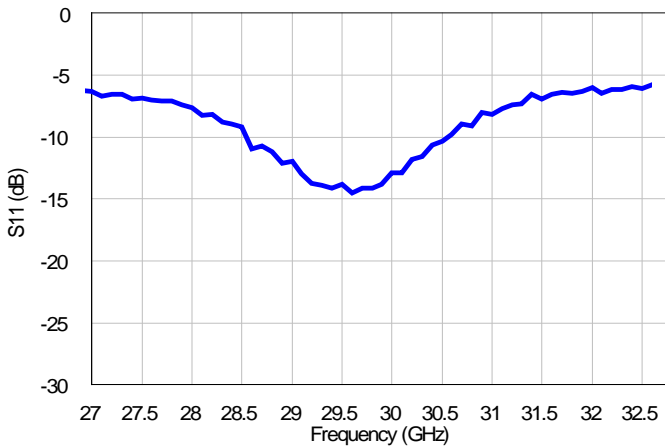

Output Return Loss vs. Frequency

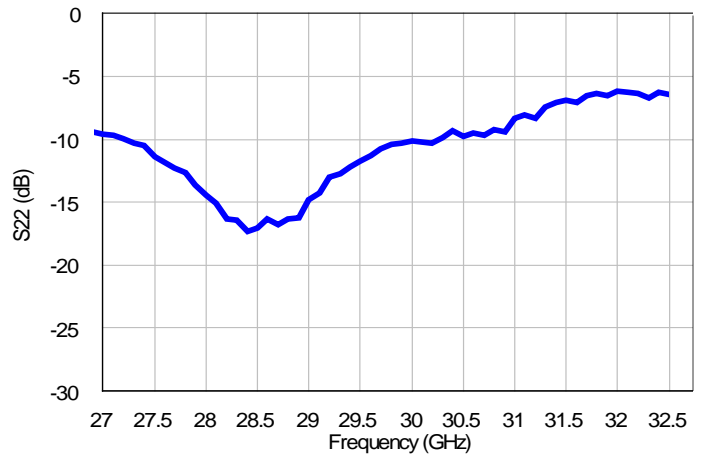

MMA-273334D-M5

27 – 33 GHz, 2.5W MMIC Power Amplifier

Pout at P1dB and P3dB Gain Compression

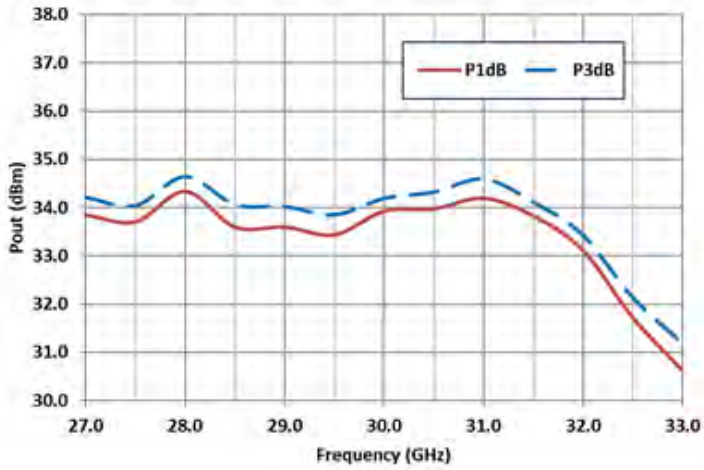

Pout and Supply Current Id vs. Input Power

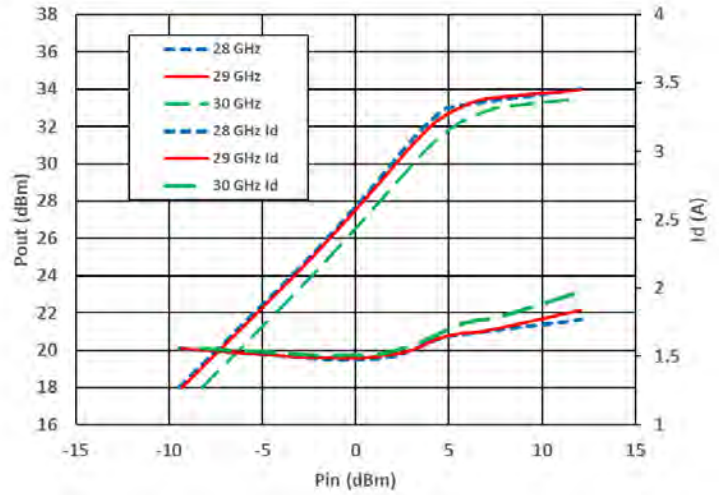

IM3 vs. Output Power

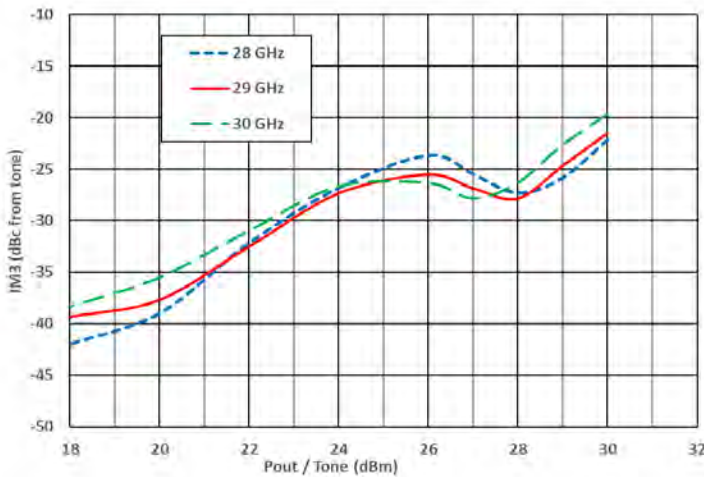

Detector Outputs vs. Output Power at 30 GHz

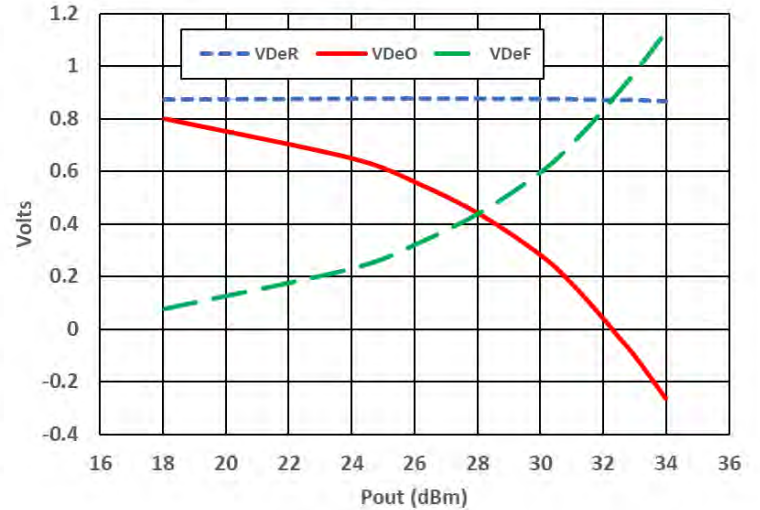

MMA-273334D-M5

27 – 33 GHz, 2.5W MMIC Power Amplifier

Package Pin Designations:

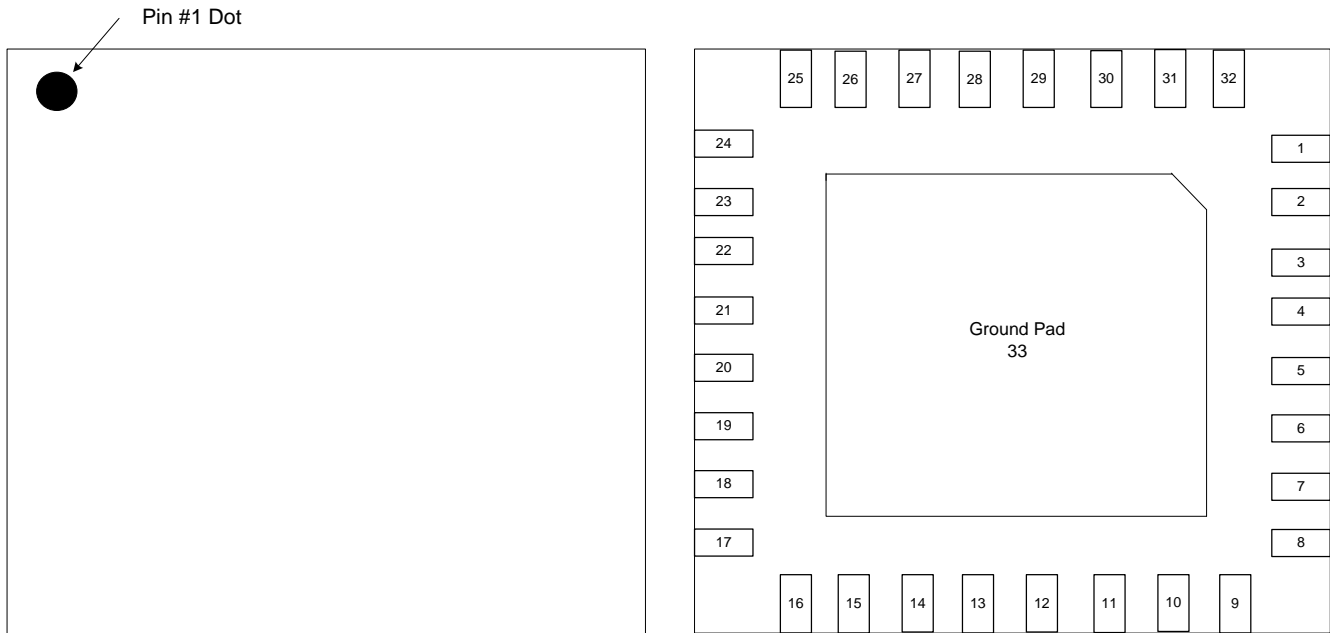

Pin	Description
4	RF Input
21	RF Output
10	Vg
31	Vd1
29	Vd2
28	Vd3
15, 26	Vd4
11	VdeR
12	VdeO
1, 3, 5, 8, 9, 16, 17, 20, 22, 24, 25, 32, 33	Ground
2, 6, 7, 11, 12, 13, 14, 18, 19, 23, 27, 30	N/C

MMA-273334D-M5

27 – 33 GHz, 2.5W MMIC Power Amplifier

Mechanical Drawing

The package is a 32-Lead 5x5mm air-cavity QFN package that is compatible with industry standard surface mount PCB assembly processes.

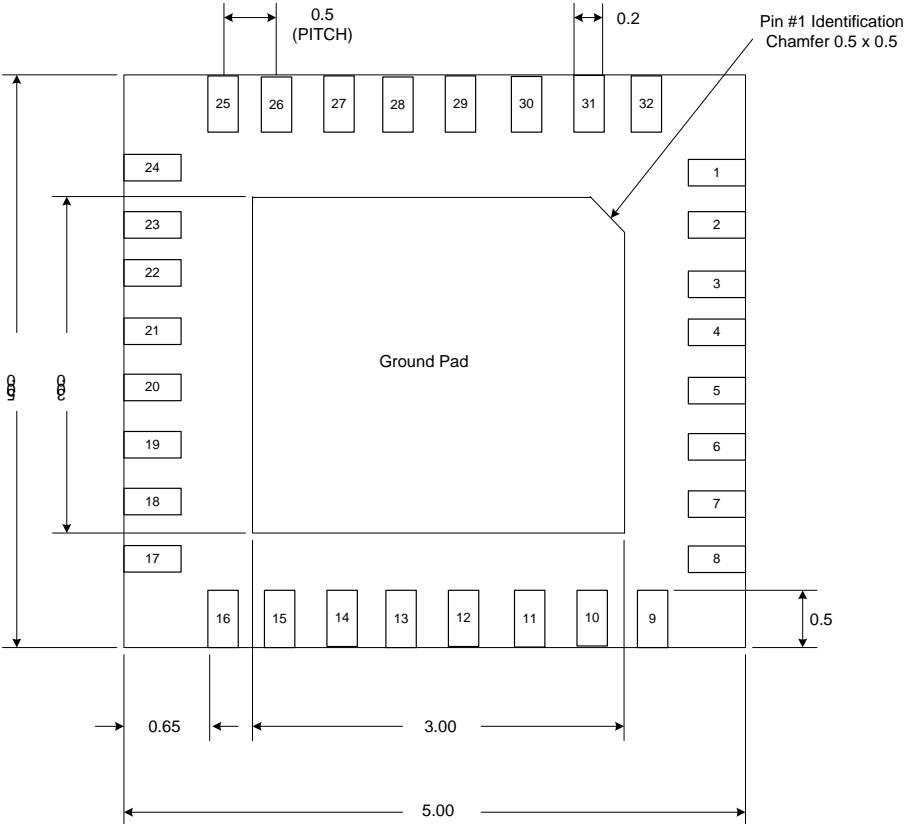

BOTTOM VIEW

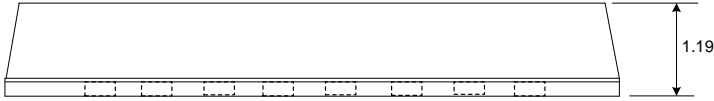

SIDE VIEW

The units are in [mm].

Sample Application Circuit:

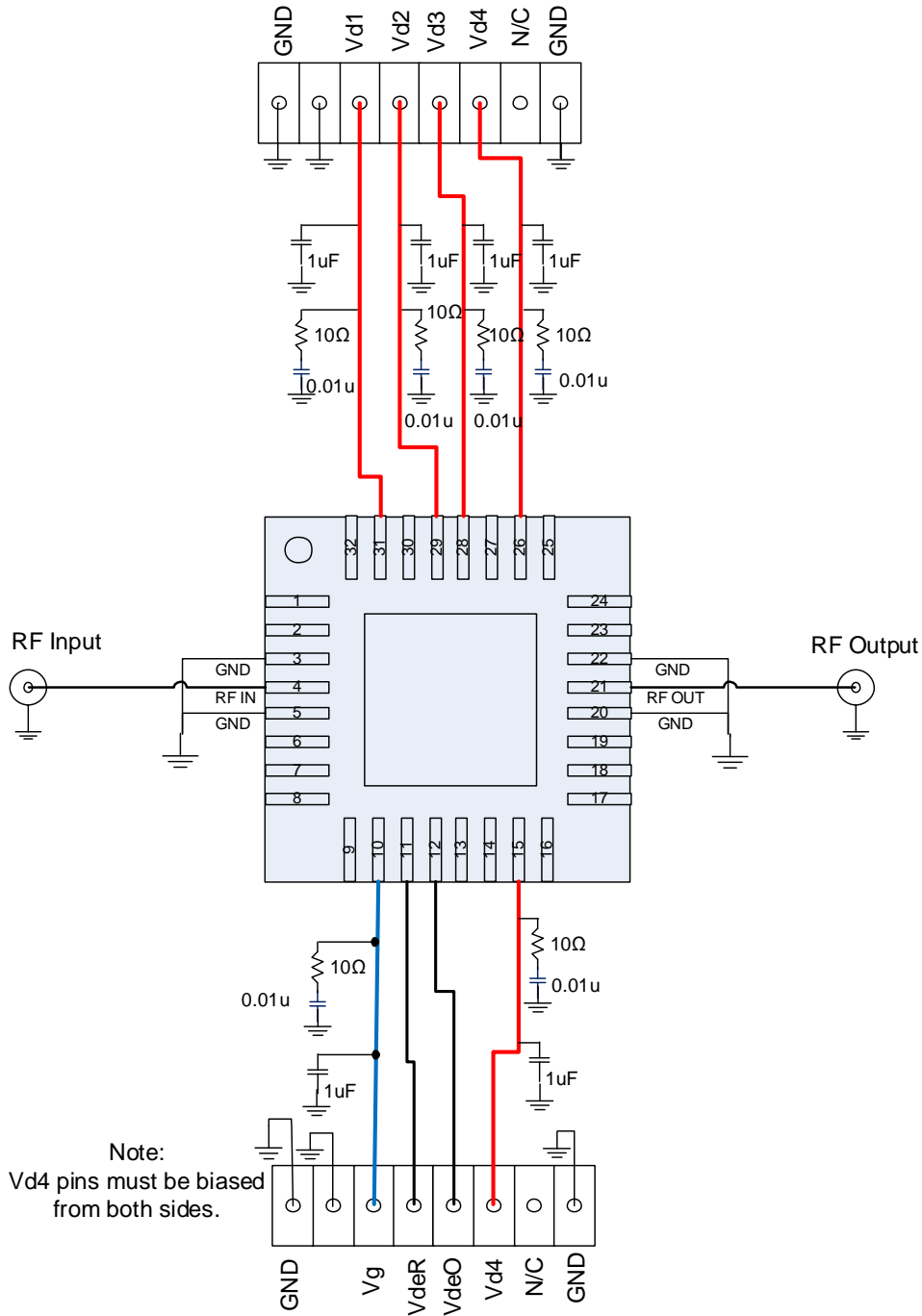

Sample Application Board Design

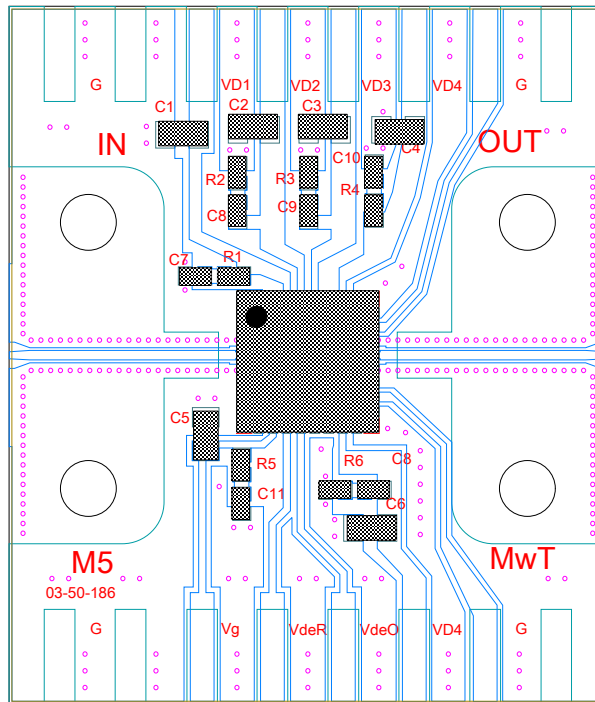

Part	Description
C1, C2, C3, C4, C5, C6	1uF capacitor (0603)
C7, C8, C9, C10, C11, C12	0.01uF Capacitor (0402)
R1, R2, R3, R4, R5, R6	10Ω Resistor (0402)
Board Material	Rogers RO4350B, 10 Mil Dielectric Thickness 1/2 oz. Copper Cladding, Copper-Filled Via Holes

Biasing and Operation

The recommended bias conditions for optimum performance for the **MMA-273334D-M5** are $V_{DD} = 6.0V$, $I_{dq} = 1600mA$. The gate voltage (V_g) must be applied prior to the drain voltages (V_{d1} , V_{d2} , V_{d3} , V_{d4}) during power up and removed after the drain voltages during power down. A single DC gate supply connected to V_g will bias all the amplifier stages. Muting can be accomplished by setting V_g to the pinch-off voltage ($V_p = -2V$). V_{d4} must be connected to both V_{d4} pins.

Assembly and Handling

GaAs MMICs are ESD sensitive. ESD preventive measures must be employed in all aspects of storage, handling, and assembly.

Application Board Design:

Proper heatsinking and board mounting pattern with filled thermal vias are recommended for optimum performance.

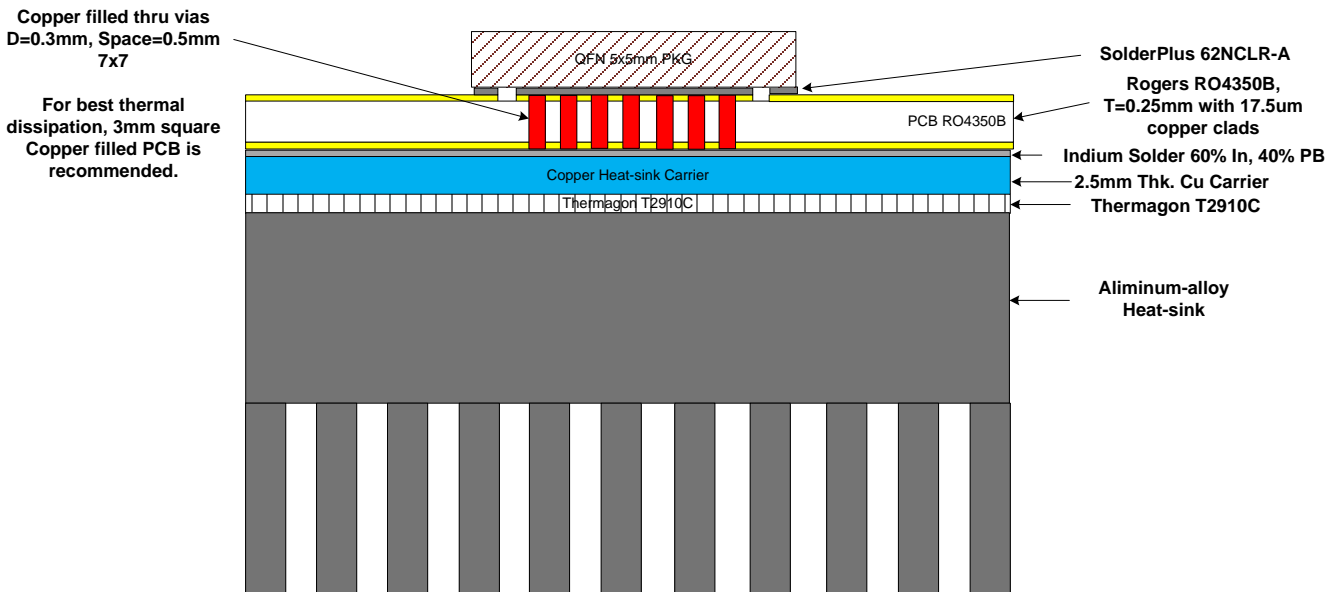

MMA-273334D-M5

27 – 33 GHz, 2.5W MMIC Power Amplifier

Contact Information

For additional information please visit www.cmlmicro.com or contact a sales office.

Europe	America	Asia
<ul style="list-style-type: none">• Maldon, UK• Tel +44 (0) 1621 875500• sales@cmlmicro.com	<ul style="list-style-type: none">• Winston-Salem, NC• Tel +1 336 744 5050• us.sales@cmlmicro.com	<ul style="list-style-type: none">• Singapore• Tel +65 6288129• sg.sales@cmlmicro.com

Although the information contained in this document is believed to be accurate, no responsibility is assumed by CML for its use. The product and product information is subject to change at any time without notice. CML has a policy of testing every product shipped using calibrated test equipment to ensure compliance with product specification.

© 2019 CML Microsystems Plc

Looking for pricing, stock, or lifecycle information?

Click below to explore more details on WIN SOURCE:

- ⊖ [View MMA-273334D-M5 on WIN SOURCE](#)
- ⊖ [CML Microcircuits Information](#)

Optimize Your Supply Chain with WIN SOURCE Solutions

- ✓ Global Sourcing Solution
- ✓ Obsolete Management
- ✓ Cost Control Management
- ✓ Shortage Management
- ✓ Alternative Solution
- ✓ Excess Inventory Management