

Product Overview

The CMD319 is a broadband MMIC low noise amplifier that is ideally suited for EW and communications systems where small size and low power consumption are needed. The device is optimized for broadband performance and delivers 20 dB of gain with a corresponding ultra low noise figure. The CMD319 is a 50 ohm matched design which eliminates the need for external DC blocks and RF port matching.

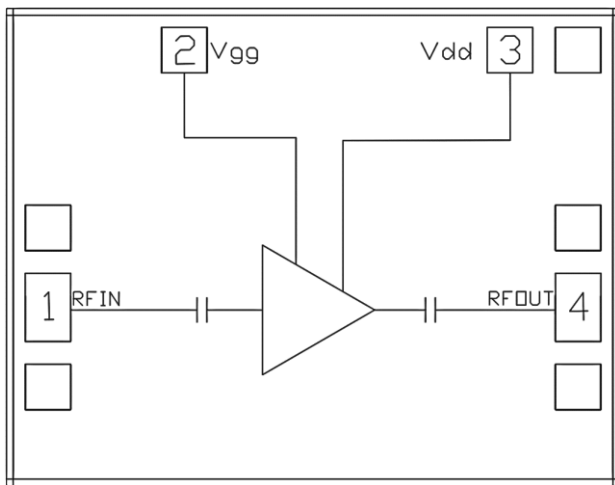

Functional Block Diagram



Key Features

- Ultra Low Noise Figure
- High Gain Broadband Performance
- Low Power Dissipation
- Small Die Size: 1350 um x 1050 um

Ordering Information

Part No.	Description
CMD319	8-12 GHz Ultra Low Noise Amplifier, 50 Piece Gel Pack

Electrical Performance ($V_{dd} = 3\text{ V}$, $V_{gg} = 1.5\text{ V}$, $T_A = 25\text{ }^\circ\text{C}$, $F = 10\text{ GHz}$)

Parameter	Min	Typ	Max	Units
Frequency Range		8 - 12		GHz
Gain		20		dB
Noise Figure		0.98		dB
Input Return Loss		19		dB
Output Return Loss		16		dB
Output P1dB		16		dBm
Supply Current		30		mA

Absolute Maximum Ratings

Parameter	Rating
Drain Voltage, V_{dd}	5.5 V
Gate Voltage, V_{gg}	3.3 V
RF Input Power	+20 dBm
Channel Temperature, T_{ch}	150 °C
Power Dissipation, P_{diss}	921 mW
Thermal Resistance, θ_{JC}	70 °C/W
Operating Temperature	-55 to 85 °C
Storage Temperature	-55 to 150 °C

Exceeding any one or combination of the maximum ratings may cause permanent damage to the device.

Recommended Operating Conditions

Parameter	Min	Typ	Max	Units
V_{dd}	2	3	5	V
V_{gg}	0	1.5	3	V
I_{dd}		30		mA
I_{gg}		2		mA

Electrical performance is measured at specific test conditions. Electrical specifications are not guaranteed over all recommended operating conditions.

Electrical Specifications ($V_{dd} = 3\text{ V}$, $V_{gg} = 1.5\text{ V}$, $T_A = 25\text{ °C}$)

Parameter	Min	Typ	Max	Min	Typ	Max	Units
Frequency Range		8 - 10			10 - 12		GHz
Gain	19	22		16	19		dB
Noise Figure		0.95	1.2		1.05	1.4	dB
Input Return Loss		19			15		dB
Output Return Loss		17			12		dB
Output P1dB		16			16		dBm
Output IP3		25			26		dBm
Supply Current	20	30	40	20	30	40	mA
Gain Temperature Coefficient		0.013			0.013		dB/°C
Noise Figure Temperature Coefficient		0.0066			0.0066		dB/°C

Typical Performance

Broadband Performance, $V_{dd} = 3\text{ V}$, $V_{gg} = 1.5\text{ V}$, $T_A = 25\text{ }^\circ\text{C}$

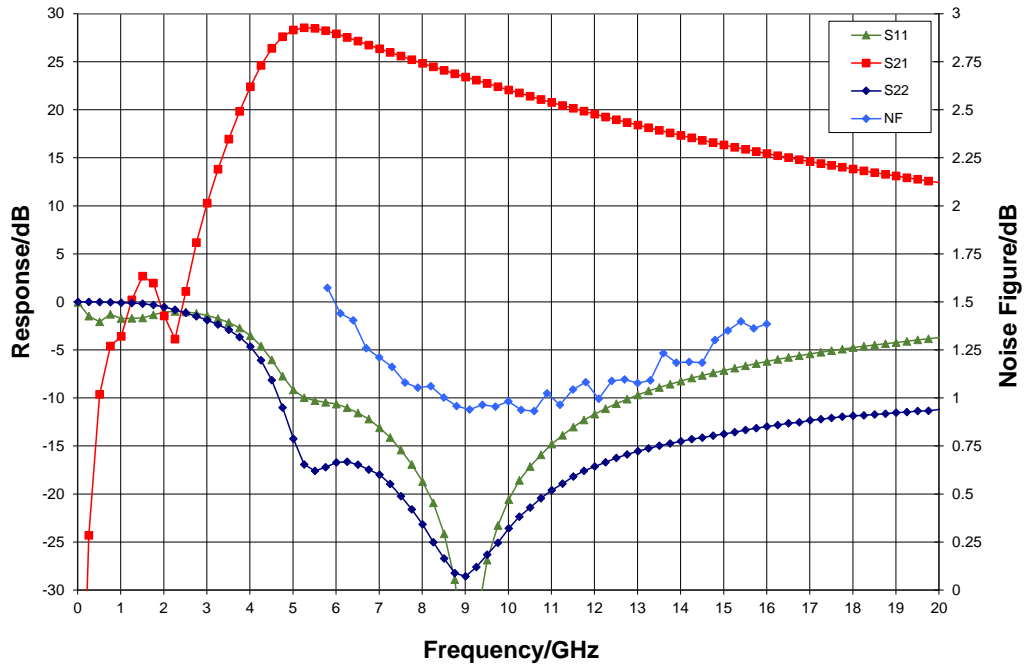

Narrow-band Performance, $V_{dd} = 3\text{ V}$, $V_{gg} = 1.5\text{ V}$, $T_A = 25\text{ }^\circ\text{C}$

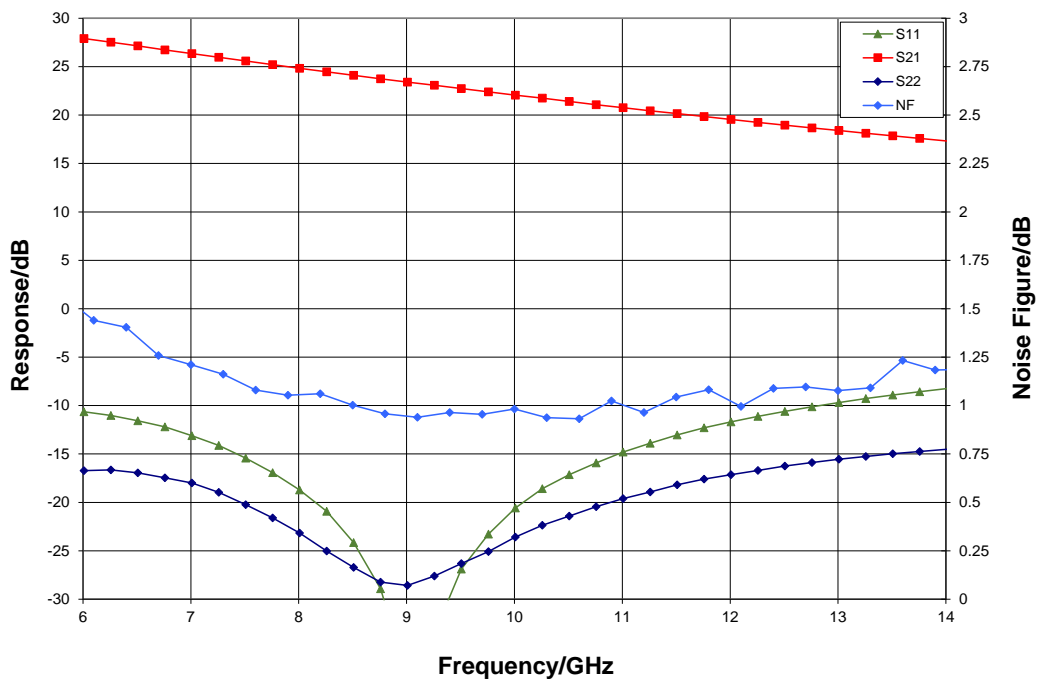

Typical Performance

Gain vs. Temperature, $V_{dd} = 3\text{ V}$, $V_{gg} = 1.5\text{ V}$

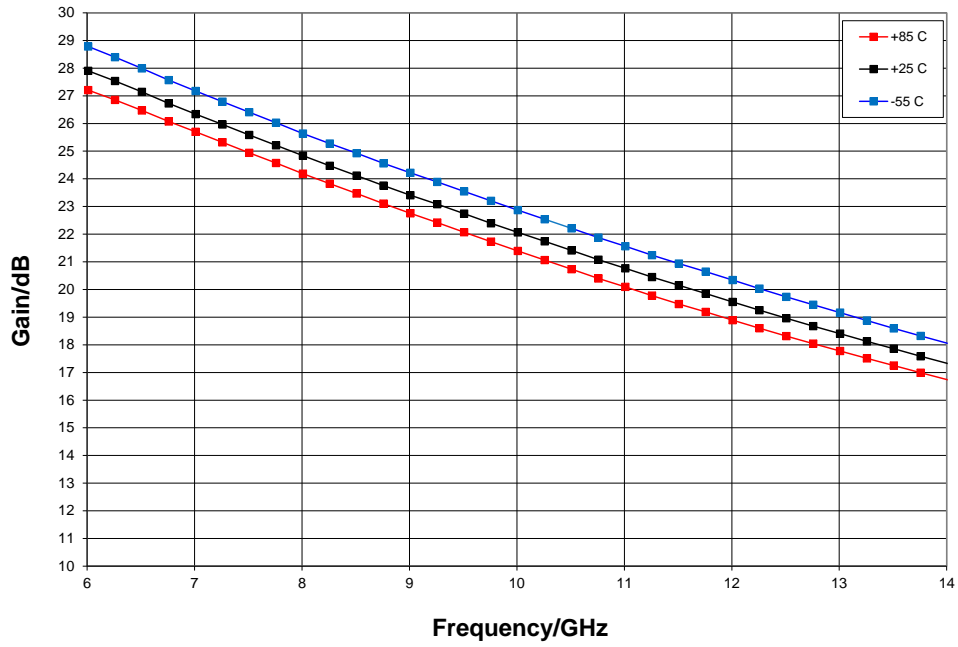

Gain vs. V_{dd} , $V_{gg} = 1.5\text{ V}$, $T_A = 25\text{ }^\circ\text{C}$

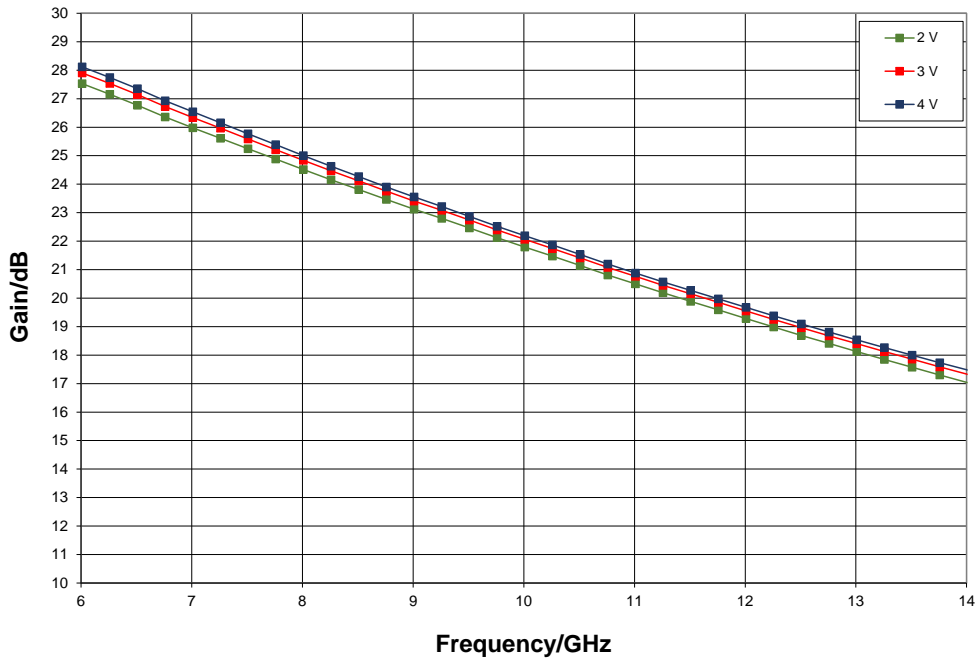

Typical Performance

Noise Figure vs. Temperature, $V_{dd} = 3\text{ V}$, $V_{gg} = 1.5\text{ V}$

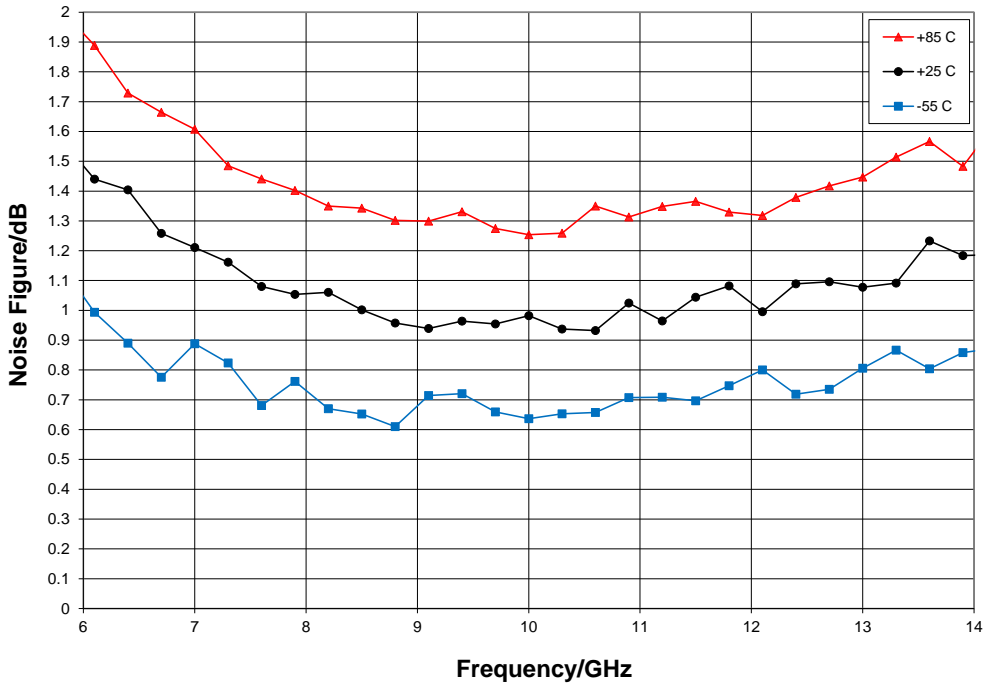

P1dB vs. Temperature, $V_{dd} = 3\text{ V}$, $V_{gg} = 1.5\text{ V}$

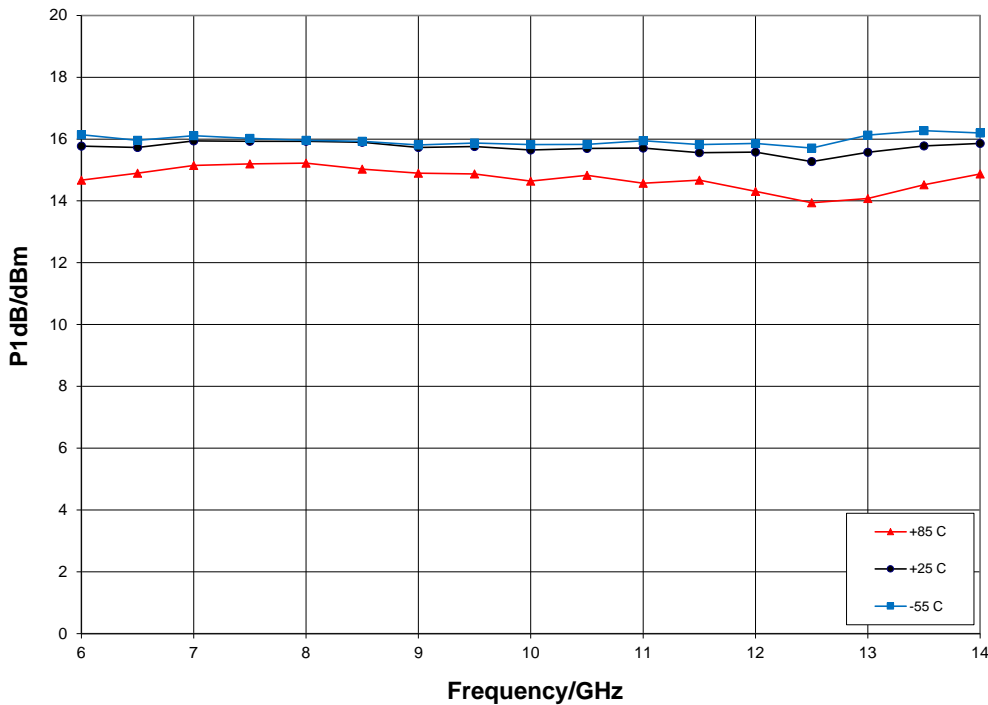

Typical Performance

P1dB vs. V_{dd} , $V_{gg} = 1.5\text{ V}$, $T_A = 25\text{ }^\circ\text{C}$

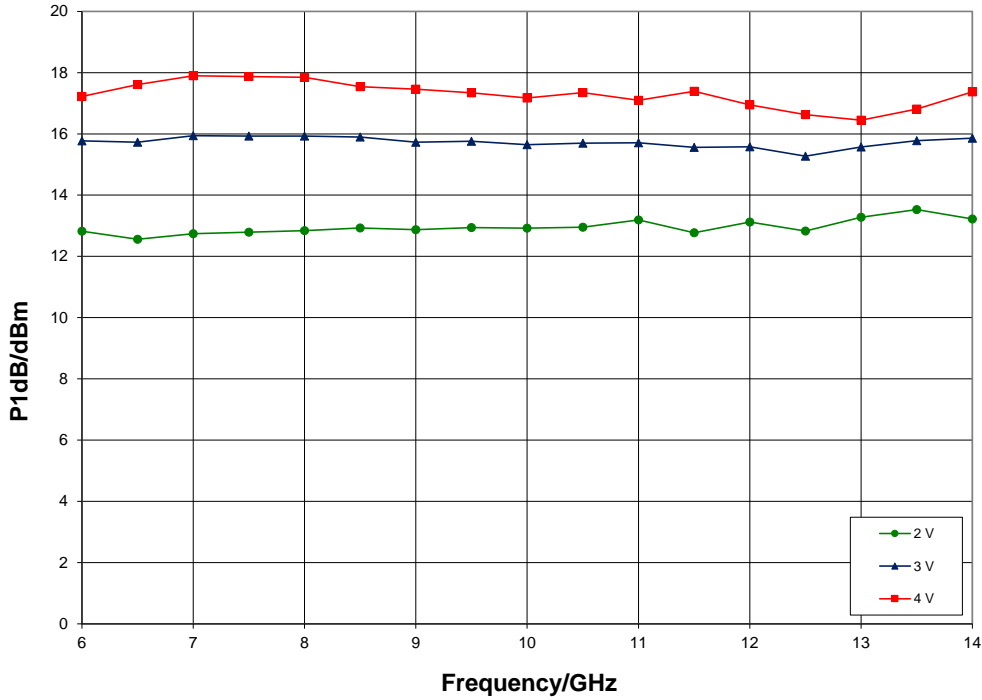

Psat vs. Temperature, $V_{dd} = 3\text{ V}$, $V_{gg} = 1.5\text{ V}$

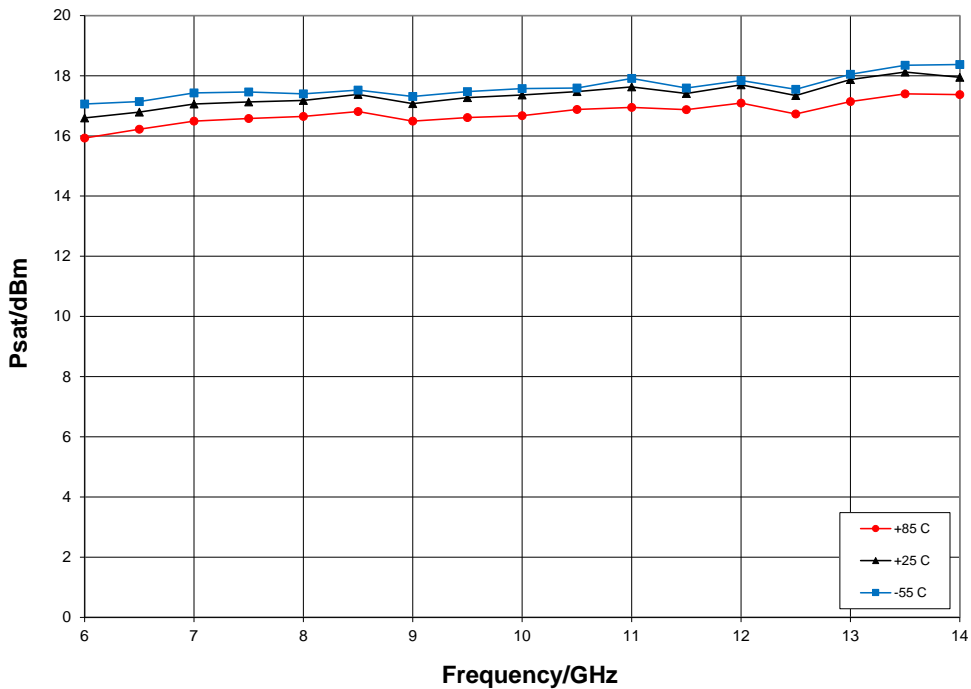

Typical Performance

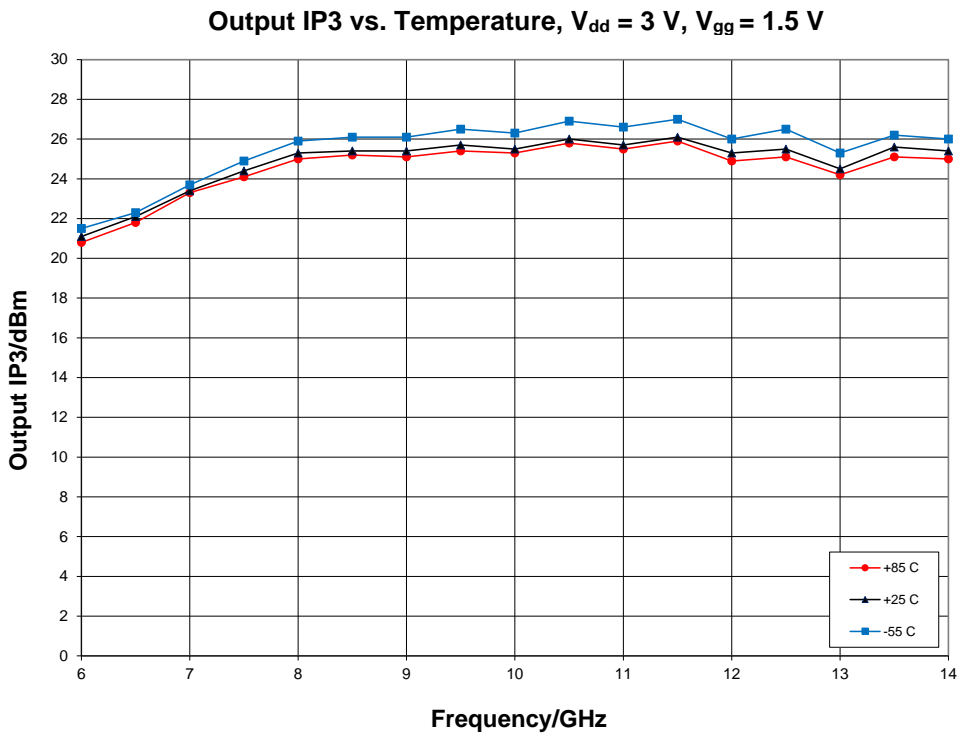
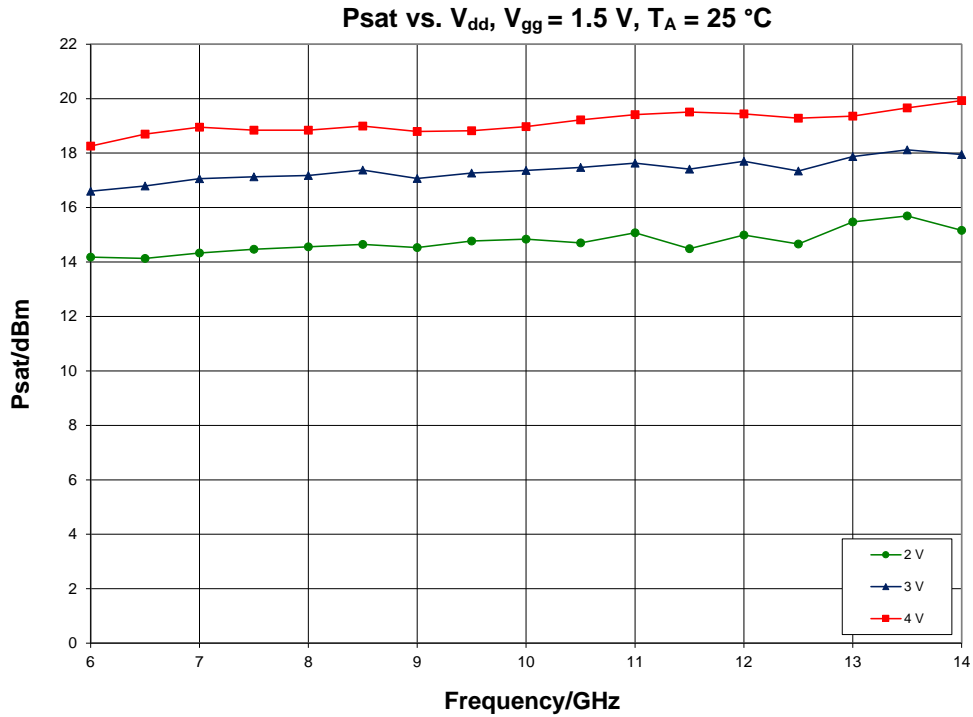

Typical Performance

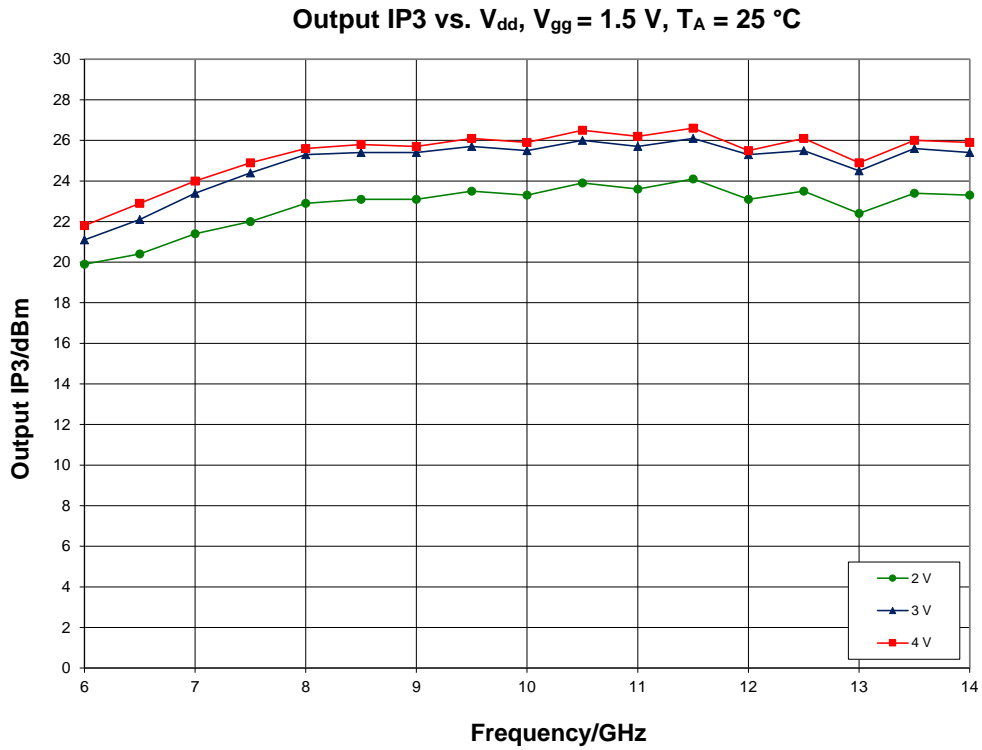

Mechanical Information

Package Information and Dimensions

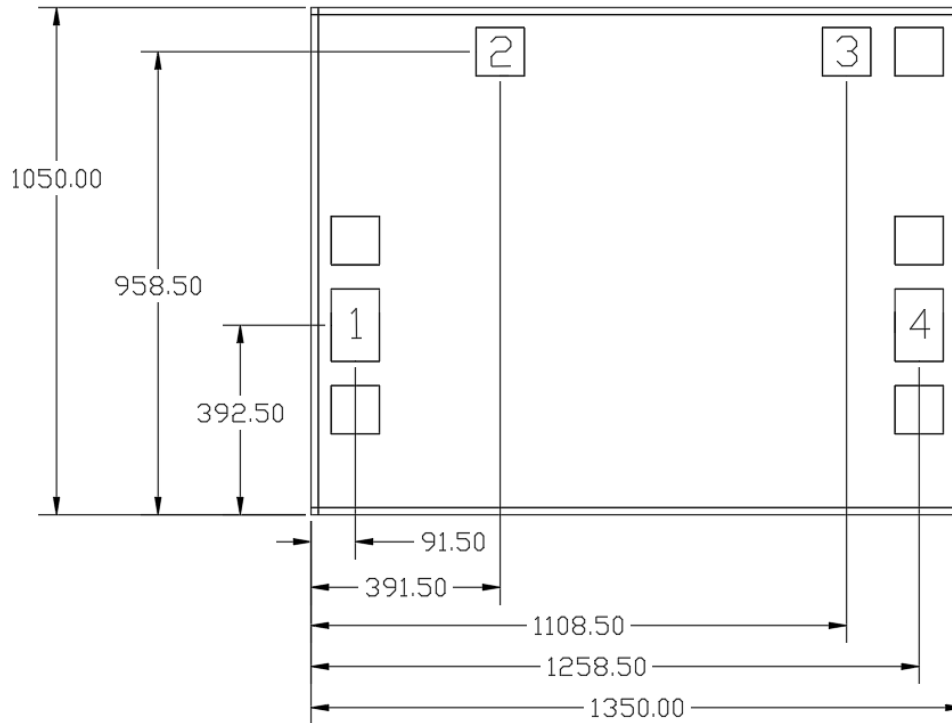

1. No connection required for unlabeled pads
2. Backside is RF and DC ground
3. Backside and bond pad metal: Gold
4. Die is 100 microns thick
5. DC bond pads (2, 3) are 100 x 100 microns
6. RF bond pads (1, 4) are 100 x 150 microns

Pin Description

Pin Diagram

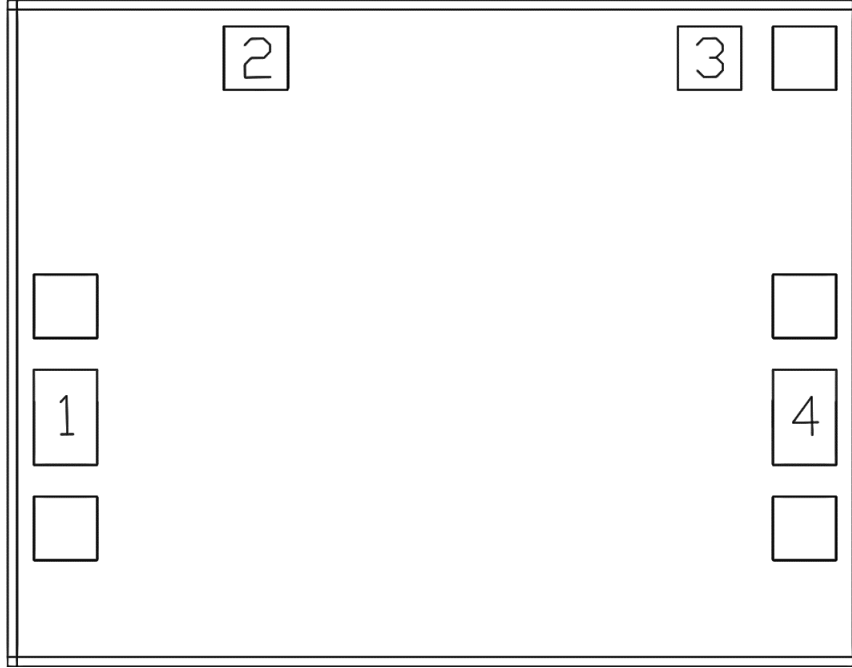

Functional Description

Pin	Function	Description	Schematic
1	RF in	DC blocked and 50 ohm matched	
2	V _{gg}	Power supply voltage Decoupling and bypass caps required	
3	V _{dd}	Power supply voltage Decoupling and bypass caps required	
4	RF out	DC blocked and 50 ohm matched	
Backside	Ground	Connect to RF / DC ground	

Applications Information

Assembly Guidelines

The backside of the CMD319 is RF ground. Die attach with electrically and thermally conductive epoxy is recommended although eutectic attach is also possible. Standard assembly procedures should be followed for high frequency devices. The top surface of the semiconductor should be made planar to the adjacent RF transmission lines, and the RF decoupling capacitors placed in close proximity to the DC connections on chip.

RF connections should be made as short as possible to reduce the inductive effect of the bond wire. Use of a 0.8 mil thermosonic wedge bonding is highly recommended as the loop height will be minimized. The RF input and output require a double bond wire as shown.

The semiconductor is 100um thick and should be handled by the sides of the die or with a custom collet. Do not make contact directly with the die surface as this will damage the monolithic circuitry. Handle with care.

Assembly Diagram

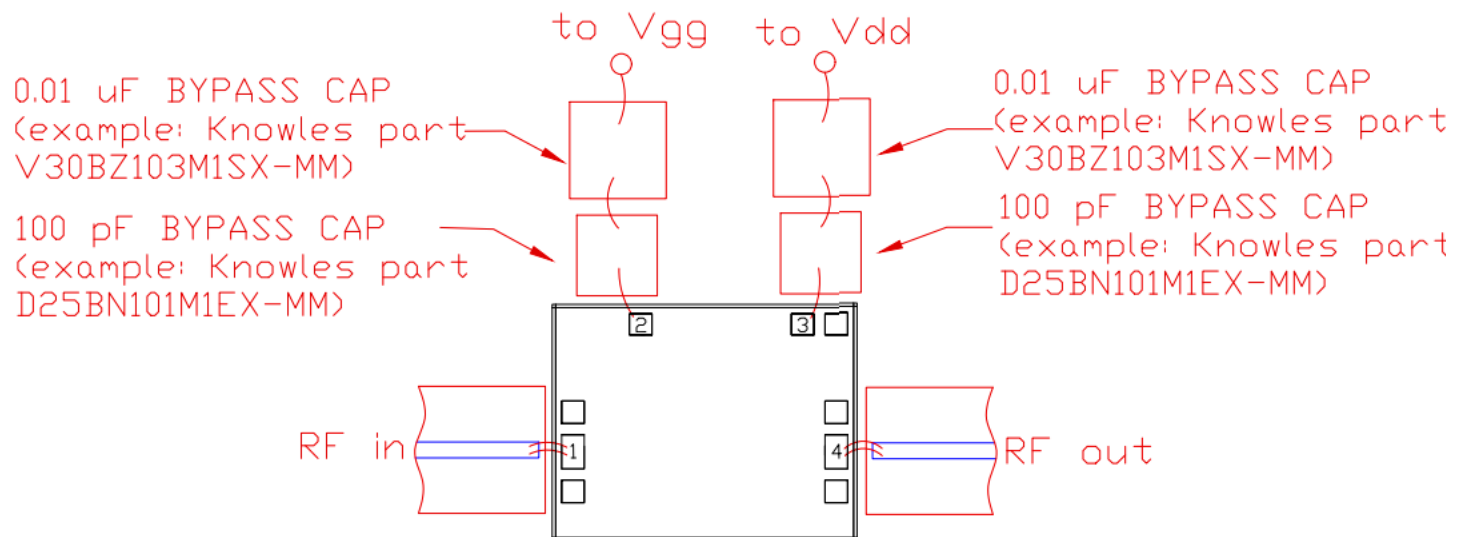

GaAs MMIC devices are susceptible to damage from Electrostatic Discharge. Proper precautions should be observed during handling, assembly and test.

Application Information

Biasing and Operation

The CMD319 is biased with a 3 V positive drain supply and a 1.5 V positive gate supply.

Turn ON procedure:

1. Apply drain voltage V_{dd} and set to +3 V
2. Apply gate voltage V_{gg} and set to +1.5 V

Turn OFF procedure:

1. Turn off gate voltage V_{gg}
2. Turn off drain voltage V_{dd}

Refer to Application Note 103: Amplifier Biasing Techniques for instructions on how to implement a single supply biasing scheme.

RF power can be applied at any time

Handling Precautions

Parameter	Rating	Standard
ESD – Human Body Model (HBM)	Class 1A	ESDA / JEDEC JS-001-2012



Caution!
 ESD-Sensitive Device

RoHS Compliance

This part is compliant with 2011/65/EU RoHS directive (Restrictions on the Use of Certain Hazardous Substances in Electrical and Electronic Equipment) as amended by Directive 2015/863/EU.

This product also has the following attributes:

- Lead Free
- Antimony Free
- TBBP-A (C₁₅H₁₂Br₄O₂) Free
- SVHC Free
- PFOS Free
- Halogen Free

Contact Information

For the latest specifications, additional product information, worldwide sales and distribution locations:

Web: www.qorvo.com

Tel: 1-844-890-8163

Email: customer.support@qorvo.com

Important Notice

The information contained in this Data Sheet and any associated documents (“Data Sheet Information”) is believed to be reliable; however, Qorvo makes no warranties regarding the Data Sheet Information and assumes no responsibility or liability whatsoever for the use of said information. All Data Sheet Information is subject to change without notice. Customers should obtain and verify the latest relevant Data Sheet Information before placing orders for Qorvo® products. Data Sheet Information or the use thereof does not grant, explicitly, implicitly or otherwise any rights or licenses to any third party with respect to patents or any other intellectual property whether with regard to such Data Sheet Information itself or anything described by such information.

DATA SHEET INFORMATION DOES NOT CONSTITUTE A WARRANTY WITH RESPECT TO THE PRODUCTS DESCRIBED HEREIN, AND QORVO HEREBY DISCLAIMS ANY AND ALL WARRANTIES WITH RESPECT TO SUCH PRODUCTS WHETHER EXPRESS OR IMPLIED BY LAW, COURSE OF DEALING, COURSE OF PERFORMANCE, USAGE OF TRADE OR OTHERWISE, INCLUDING THE IMPLIED WARRANTIES OF MERCHANTABILITY AND FITNESS FOR A PARTICULAR PURPOSE. Without limiting the generality of the foregoing, Qorvo® products are not warranted or authorized for use as critical components in medical, life-saving, or life-sustaining applications, or other applications where a failure would reasonably be expected to cause severe personal injury or death. Applications described in the Data Sheet Information are for illustrative purposes only. Customers are responsible for validating that a particular product described in the Data Sheet Information is suitable for use in a particular application.

© 2022 Qorvo US, Inc. All rights reserved. This document is subject to copyright laws in various jurisdictions worldwide and may not be reproduced or distributed, in whole or in part, without the express written consent of Qorvo US, Inc. | QORVO® is a registered trademark of Qorvo US, Inc

Looking for pricing, stock, or lifecycle information?

Click below to explore more details on WIN SOURCE:

 [View CMD319 on WIN SOURCE](#)

 [Qorvo US Inc. Information](#)

Optimize Your Supply Chain with WIN SOURCE Solutions

-  Global Sourcing Solution
-  Obsolete Management
-  Cost Control Management
-  Shortage Management
-  Alternative Solution
-  Excess Inventory Management