

## Features

- Optimized for 1.8V systems
  - As fast as 4.6 ns pin-to-pin logic delays
  - As low as 15  $\mu$ A quiescent current
- Industry's best 0.18 micron CMOS CPLD
  - Optimized architecture for effective logic synthesis
  - Multi-voltage I/O operation — 1.5V to 3.3V
- Available in multiple package options
  - 44-pin VQFP with 33 user I/Os
  - 48-land QFN with 37 user I/Os
  - 56-ball CP BGA with 45 user I/Os
  - 100-pin VQFP with 64 user I/Os
  - Pb-free available for all packages
- Advanced system features
  - Fastest in system programming
    - 1.8V ISP using IEEE 1532 (JTAG) interface
  - IEEE1149.1 JTAG Boundary Scan Test
  - Optional Schmitt-trigger input (per pin)
  - Two separate I/O banks
  - RealDigital 100% CMOS product term generation
  - Flexible clocking modes
    - Optional DualEDGE triggered registers
  - Global signal options with macrocell control
    - Multiple global clocks with phase selection per macrocell
    - Multiple global output enables
    - Global set/reset
  - Efficient control term clocks, output enables, and set/resets for each macrocell and shared across function blocks
  - Advanced design security
  - Optional bus-hold, 3-state, or weak pullup on selected I/O pins
  - Open-drain output option for Wired-OR and LED drive
  - Optional configurable grounds on unused I/Os
  - Mixed I/O voltages compatible with 1.5V, 1.8V, 2.5V, and 3.3V logic levels
  - PLA architecture
    - Superior pinout retention
    - 100% product term routability across function block
  - Hot pluggable

Refer to the CoolRunner™-II family data sheet for architecture description.

## Description

The CoolRunner-II 64-macrocell device is designed for both high performance and low power applications. This lends power savings to high-end communication equipment and high speed to battery operated devices. Due to the low power stand-by and dynamic operation, overall system reliability is improved.

This device consists of four Function Blocks inter-connected by a low power Advanced Interconnect Matrix (AIM). The AIM feeds 40 true and complement inputs to each Function Block. The Function Blocks consist of a 40 by 56 P-term PLA and 16 macrocells which contain numerous configuration bits that allow for combinational or registered modes of operation.

Additionally, these registers can be globally reset or preset and configured as a D or T flip-flop or as a D latch. There are also multiple clock signals, both global and local product term types, configured on a per macrocell basis. Output pin configurations include slew rate limit, bus hold, pull-up, open drain, and programmable grounds. A Schmitt trigger input is available on a per input pin basis. In addition to storing macrocell output states, the macrocell registers can be configured as "direct input" registers to store signals directly from input pins.

Clocking is available on a global or Function Block basis. Three global clocks are available for all Function Blocks as a synchronous clock source. Macrocell registers can be individually configured to power up to the zero or one state. A global set/reset control line is also available to asynchronously set or reset selected registers during operation. Additional local clock, synchronous clock-enable, asynchronous set/reset, and output enable signals can be formed using product terms on a per-macrocell or per-Function Block basis.

A DualEDGE flip-flop feature is also available on a per macrocell basis. This feature allows high performance synchronous operation based on lower frequency clocking to help reduce the total power consumption of the device.

The CoolRunner-II 64-macrocell CPLD is I/O compatible with standard LVTTTL and LVC MOS18, LVC MOS25, and LVC MOS33 (see [Table 1](#)). This device is also 1.5V I/O compatible with the use of Schmitt-trigger inputs.

Another feature that eases voltage translation is I/O banking. Two I/O banks are available on the CoolRunner-II 64A macrocell device that permit easy interfacing to 3.3V, 2.5V, 1.8V, and 1.5V devices.

## RealDigital Design Technology

Xilinx® CoolRunner-II CPLDs are fabricated on a 0.18 micron process technology which is derived from leading edge FPGA product development. CoolRunner-II CPLDs employ RealDigital, a design technique that makes use of CMOS technology in both the fabrication and design methodology. RealDigital design technology employs a cascade of CMOS gates to implement sum of products instead of traditional sense amplifier methodology. Due to this technology, Xilinx CoolRunner-II CPLDs achieve both high performance and low power operation.

## Supported I/O Standards

The CoolRunner-II 64 macrocell features both LVCMOS and LVTTL I/O implementations. See [Table 1](#) for I/O standard voltages. The LVTTL I/O standard is a general purpose EIA/JEDEC standard for 3.3V applications that use an

LVTTL input buffer and Push-Pull output buffer. The LVCMOS standard is used in 3.3V, 2.5V, and 1.8V applications. CoolRunner-II CPLDs are also 1.5V I/O compatible with the use of Schmitt-trigger inputs.

Table 1: I/O Standards for XC2C64A

IOSTANDARD Attribute	Output $V_{CCIO}$	Input $V_{CCIO}$	Input $V_{REF}$	Board Termination Voltage $V_T$
LVTTL	3.3	3.3	N/A	N/A
LVCMOS33	3.3	3.3	N/A	N/A
LVCMOS25	2.5	2.5	N/A	N/A
LVCMOS18	1.8	1.8	N/A	N/A
LVCMOS15 <sup>(1)</sup>	1.5	1.5	N/A	N/A

1. LVCMOS15 requires Schmitt-trigger inputs.

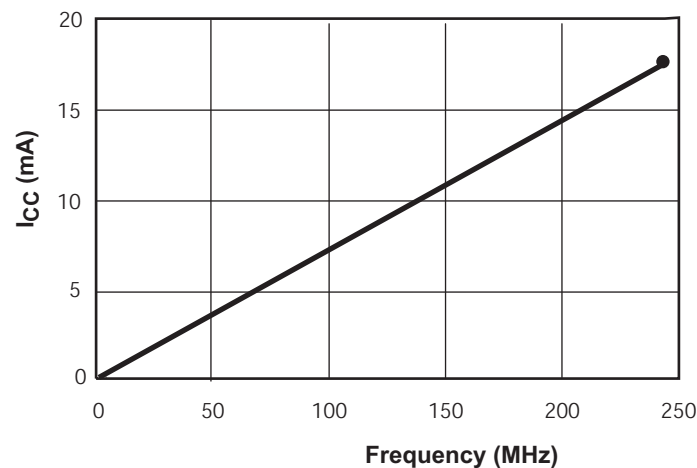

DS092\_01\_092302

Figure 1: I<sub>CC</sub> vs Frequency

Table 2: I<sub>CC</sub> vs Frequency (LVCMOS 1.8V T<sub>A</sub> = 25°C)<sup>(1)</sup>

	Frequency (MHz)									
	0	25	50	75	100	150	175	200	225	240
Typical I <sub>CC</sub> (mA)	0.017	1.8	3.7	5.5	7.48	11.0	12.7	14.6	15.3	17.77

### Notes:

- 16-bit up/down, Resettable binary counter (one counter per function block).

## Absolute Maximum Ratings

Symbol	Description	Value	Units
$V_{CC}$	Supply voltage relative to ground	-0.5 to 2.0	V
$V_{CCIO}$	Supply voltage for output drivers	-0.5 to 4.0	V
$V_{JTAG}^{(2)}$	JTAG input voltage limits	-0.5 to 4.0	V
$V_{CCAUX}$	JTAG input supply voltage	-0.5 to 4.0	V
$V_{IN}^{(1)}$	Input voltage relative to ground <sup>(1)</sup>	-0.5 to 4.0	V
$V_{TS}^{(1)}$	Voltage applied to 3-state output <sup>(1)</sup>	-0.5 to 4.0	V
$V_{STG}^{(3)}$	Storage Temperature (ambient)	-65 to +150	°C
$T_J$	Junction Temperature	+150	°C

### Notes:

- Maximum DC undershoot below GND must be limited to either 0.5V or 10 mA, whichever is easiest to achieve. During transitions, the device pins might undershoot to -2.0V or overshoot to +4.5V, provided this overshoot or undershoot lasts less than 10 ns and with the forcing current being limited to 200 mA.
- Valid over commercial temperature range.
- For soldering guidelines and thermal considerations, see the [Device Packaging](#) information on the Xilinx website. For Pb free packages, see [XAPP427](#).

## Recommended Operating Conditions

Symbol	Parameter		Min	Max	Units
$V_{CC}$	Supply voltage for internal logic and input buffers	Commercial $T_A = 0^\circ\text{C}$ to $+70^\circ\text{C}$	1.7	1.9	V
		Industrial $T_A = -40^\circ\text{C}$ to $+85^\circ\text{C}$	1.7	1.9	V
$V_{CCIO}$	Supply voltage for output drivers @ 3.3V operation		3.0	3.6	V
	Supply voltage for output drivers @ 2.5V operation		2.3	2.7	V
	Supply voltage for output drivers @ 1.8V operation		1.7	1.9	V
	Supply voltage for output drivers @ 1.5V operation		1.4	1.6	V
$V_{CCAUX}$	JTAG programming pins		1.7	3.6	V

## DC Electrical Characteristics Over Recommended Operating Conditions

Symbol	Parameter	Test Conditions	Typical	Max.	Units
$I_{CCSB}$	Standby current Commercial	$V_{CC} = 1.9\text{V}$ , $V_{CCIO} = 3.6\text{V}$	31	100	$\mu\text{A}$
$I_{CCSB}$	Standby current Industrial	$V_{CC} = 1.9\text{V}$ , $V_{CCIO} = 3.6\text{V}$	43	165	$\mu\text{A}$
$I_{CC}^{(1)}$	Dynamic current	$f = 1\text{ MHz}$	-	500	$\mu\text{A}$
		$f = 50\text{ MHz}$	-	5	mA
$C_{JTAG}$	JTAG input capacitance	$f = 1\text{ MHz}$	-	10	pF
$C_{CLK}$	Global clock input capacitance	$f = 1\text{ MHz}$	-	12	pF
$C_{IO}$	I/O capacitance	$f = 1\text{ MHz}$	-	10	pF
$I_{IL}^{(2)}$	Input leakage current	$V_{IN} = 0\text{V}$ or $V_{CCIO}$ to 3.9V	-	+/-1	$\mu\text{A}$
$I_{IH}^{(2)}$	I/O High-Z leakage	$V_{IN} = 0\text{V}$ or $V_{CCIO}$ to 3.9V	-	+/-1	$\mu\text{A}$

### Notes:

- 16-bit up/down, Resettable binary counter (one counter per function block) tested at  $V_{CC}=V_{CCIO}=1.9\text{V}$ .
- See Quality and Reliability section of the CoolRunner-II family data sheet.

## LVC MOS 3.3V and LV TTL 3.3V DC Voltage Specifications

Symbol	Parameter	Test Conditions	Min.	Max.	Units
$V_{CCIO}$	Input source voltage		3.0	3.6	V
$V_{IH}$	High level input voltage		2	3.9	V
$V_{IL}$	Low level input voltage		-0.3	0.8	V
$V_{OH}$	High level output voltage	$I_{OH} = -8 \text{ mA}, V_{CCIO} = 3\text{V}$	$V_{CCIO} - 0.4\text{V}$	-	V
		$I_{OH} = -0.1 \text{ mA}, V_{CCIO} = 3\text{V}$	$V_{CCIO} - 0.2\text{V}$	-	V
$V_{OL}$	Low level output voltage	$I_{OL} = 8 \text{ mA}, V_{CCIO} = 3\text{V}$	-	0.4	V
		$I_{OL} = 0.1 \text{ mA}, V_{CCIO} = 3\text{V}$	-	0.2	V

## LVC MOS 2.5V DC Voltage Specifications

Symbol	Parameter	Test Conditions	Min.	Max.	Units
$V_{CCIO}$	Input source voltage		2.3	2.7	V
$V_{IH}$	High level input voltage		1.7	$V_{CCIO} + 0.3^{(1)}$	V
$V_{IL}$	Low level input voltage		-0.3	0.7	V
$V_{OH}$	High level output voltage	$I_{OH} = -8 \text{ mA}, V_{CCIO} = 2.3\text{V}$	$V_{CCIO} - 0.4\text{V}$	-	V
		$I_{OH} = -0.1 \text{ mA}, V_{CCIO} = 2.3\text{V}$	$V_{CCIO} - 0.2\text{V}$	-	V
$V_{OL}$	Low level output voltage	$I_{OL} = 8 \text{ mA}, V_{CCIO} = 2.3\text{V}$	-	0.4	V
		$I_{OL} = 0.1 \text{ mA}, V_{CCIO} = 2.3\text{V}$	-	0.2	V

1. The  $V_{IH}$  Max value represents the JEDEC specification for LVC MOS25. The CoolRunner-II CPLD input buffer can tolerate up to 3.9V without physical damage.

## LVC MOS 1.8V DC Voltage Specifications

Symbol	Parameter	Test Conditions	Min.	Max.	Units
$V_{CCIO}$	Input source voltage	-	1.7	1.9	V
$V_{IH}$	High level input voltage	-	$0.65 \times V_{CCIO}$	$V_{CCIO} + 0.3^{(1)}$	V
$V_{IL}$	Low level input voltage	-	-0.3	$0.35 \times V_{CCIO}$	V
$V_{OH}$	High level output voltage	$I_{OH} = -8 \text{ mA}, V_{CCIO} = 1.7\text{V}$	$V_{CCIO} - 0.45$	-	V
		$I_{OH} = -0.1 \text{ mA}, V_{CCIO} = 1.7\text{V}$	$V_{CCIO} - 0.2$	-	V
$V_{OL}$	Low level output voltage	$I_{OL} = 8 \text{ mA}, V_{CCIO} = 1.7\text{V}$	-	0.45	V
		$I_{OL} = 0.1 \text{ mA}, V_{CCIO} = 1.7\text{V}$	-	0.2	V

1. The  $V_{IH}$  Max value represents the JEDEC specification for LVC MOS18. The CoolRunner-II CPLD input buffer can tolerate up to 3.9V without physical damage.

## LVCMOS 1.5V DC Voltage Specifications

Symbol	Parameter <sup>(1)</sup>	Test Conditions	Min.	Max.	Units
$V_{CCIO}$	Input source voltage	-	1.4	1.6	V
$V_{T+}$	Input hysteresis threshold voltage	-	$0.5 \times V_{CCIO}$	$0.8 \times V_{CCIO}$	V
$V_{T-}$		-	$0.2 \times V_{CCIO}$	$0.5 \times V_{CCIO}$	V
$V_{OH}$	High level output voltage	$I_{OH} = -8 \text{ mA}, V_{CCIO} = 1.4\text{V}$	$V_{CCIO} - 0.45$	-	V
		$I_{OH} = -0.1 \text{ mA}, V_{CCIO} = 1.4\text{V}$	$V_{CCIO} - 0.2$	-	V
$V_{OL}$	Low level output voltage	$I_{OL} = 8 \text{ mA}, V_{CCIO} = 1.4\text{V}$	-	0.4	V
		$I_{OL} = 0.1 \text{ mA}, V_{CCIO} = 1.4\text{V}$	-	0.2	V

### Notes:

1. Hysteresis used on 1.5V inputs.

## Schmitt Trigger Input DC Voltage Specifications

Symbol	Parameter	Test Conditions	Min.	Max.	Units
$V_{CCIO}$	Input source voltage	-	1.4	3.9	V
$V_{T+}$	Input hysteresis threshold voltage	-	$0.5 \times V_{CCIO}$	$0.8 \times V_{CCIO}$	V
$V_{T-}$		-	$0.2 \times V_{CCIO}$	$0.5 \times V_{CCIO}$	V

## AC Electrical Characteristics Over Recommended Operating Conditions

Symbol	Parameter	-5		-7		Units
		Min.	Max.	Min.	Max.	
T <sub>PD1</sub>	Propagation delay single p-term	-	4.6	-	6.7	ns
T <sub>PD2</sub>	Propagation delay OR array	-	5.0	-	7.5	ns
T <sub>SUD</sub>	Direct input register clock setup time	2.4	-	3.3	-	ns
T <sub>SU1</sub>	Setup time (single p-term)	2.0	-	2.5	-	ns
T <sub>SU2</sub>	Setup time (OR array)	2.4	-	3.3	-	ns
T <sub>HD</sub>	Direct input register hold time	0	-	0	-	ns
T <sub>H</sub>	P-term hold time	0	-	0	-	ns
T <sub>CO</sub>	Clock to output	-	3.9	-	6.0	ns
F <sub>TOGGLE</sub> <sup>(1)</sup>	Internal toggle rate <sup>(1)</sup>	-	500	-	300	MHz
F <sub>SYSTEM1</sub> <sup>(2)</sup>	Maximum system frequency <sup>(2)</sup>	-	263	-	159	MHz
F <sub>SYSTEM2</sub> <sup>(2)</sup>	Maximum system frequency <sup>(2)</sup>	-	238	-	141	MHz
F <sub>EXT1</sub> <sup>(3)</sup>	Maximum external frequency <sup>(3)</sup>	-	169	-	118	MHz
F <sub>EXT2</sub> <sup>(3)</sup>	Maximum external frequency <sup>(3)</sup>	-	159	-	108	MHz
T <sub>PSUD</sub>	Direct input register p-term clock setup time	0.9	-	1.7	-	ns
T <sub>PSU1</sub>	P-term clock setup time (single p-term)	0.6	-	0.9	-	ns
T <sub>PSU2</sub>	P-term clock setup time (OR array)	1.0	-	1.7	-	ns
T <sub>PHD</sub>	Direct input register p-term clock hold time	1.3	-	1.4	-	ns
T <sub>PH</sub>	P-term clock hold	1.5	-	1.7	-	ns
T <sub>PCO</sub>	P-term clock to output	-	6.0	-	8.4	ns
T <sub>OE</sub> /T <sub>OD</sub>	Global OE to output enable/disable	-	8.0	-	10.0	ns
T <sub>POE</sub> /T <sub>POD</sub>	P-term OE to output enable/disable	-	9.0	-	11.0	ns
T <sub>MOE</sub> /T <sub>MOD</sub>	Macrocell driven OE to output enable/disable	-	9.0	-	11.0	ns
T <sub>PAO</sub>	P-term set/reset to output valid	-	7.3	-	9.7	ns
T <sub>AO</sub>	Global set/reset to output valid	-	6.0	-	8.3	ns
T <sub>SUEC</sub>	Register clock enable setup time	3.0	-	3.7	-	ns
T <sub>HEC</sub>	Register clock enable hold time	0	-	0	-	ns
T <sub>CW</sub>	Global clock pulse width High or Low	1.4	-	2.2	-	ns
T <sub>PCW</sub>	P-term pulse width High or Low	5.0	-	7.5	-	ns
T <sub>APRPW</sub>	Asynchronous preset/reset pulse width (High or Low)	5.0	-	7.5	-	ns
T <sub>CONFIG</sub> <sup>(4)</sup>	Configuration time	-	50.0	-	50.0	μs

### Notes:

1. F<sub>TOGGLE</sub> is the maximum frequency of a dual edge triggered T flip-flop with output enabled.
2. F<sub>SYSTEM</sub> (1/T<sub>CYCLE</sub>) is the internal operating frequency for a device fully populated with 16-bit up/down, Resettable binary counter (one counter per function block).
3. F<sub>EXT</sub> (1/T<sub>SU1</sub>+T<sub>CO</sub>) is the maximum external frequency.
4. Typical configuration current during T<sub>CONFIG</sub> is 2.3 mA.

## Internal Timing Parameters

Symbol	Parameter <sup>(1)</sup>	-5		-7		Units
		Min.	Max.	Min.	Max.	
<b>Buffer Delays</b>						
T <sub>IN</sub>	Input buffer delay	-	1.7	-	2.4	ns
T <sub>DIN</sub>	Direct data register input delay	-	2.6	-	4.0	ns
T <sub>GCK</sub>	Global clock buffer delay	-	1.6	-	2.5	ns
T <sub>GSR</sub>	Global set/reset buffer delay	-	2.4	-	3.5	ns
T <sub>GTS</sub>	Global 3-state buffer delay	-	2.7	-	3.9	ns
T <sub>OUT</sub>	Output buffer delay	-	1.9	-	2.8	ns
T <sub>EN</sub>	Output buffer enable/disable delay	-	5.3	-	6.1	ns
<b>P-term Delays</b>						
T <sub>CT</sub>	Control term delay	-	2.0	-	2.5	ns
T <sub>LOGI1</sub>	Single P-term delay adder	-	0.5	-	0.8	ns
T <sub>LOGI2</sub>	Multiple P-term delay adder	-	0.4	-	0.8	ns
<b>Macrocell Delay</b>						
T <sub>PDI</sub>	Input to output valid	-	0.5	-	0.7	ns
T <sub>SUI</sub>	Setup before clock	1.4	-	1.8	-	ns
T <sub>HI</sub>	Hold after clock	0.0	-	0.0	-	ns
T <sub>ECSU</sub>	Enable clock setup time	0.9	-	1.3	-	ns
T <sub>ECHO</sub>	Enable clock hold time	0	-	0	-	ns
T <sub>COI</sub>	Clock to output valid	-	0.4	-	0.7	ns
T <sub>AOI</sub>	Set/reset to output valid	-	1.7	-	2.0	ns
T <sub>CDBL</sub>	Clock doubler delay	-	0	-	0	ns
<b>Feedback Delays</b>						
T <sub>F</sub>	Feedback delay	-	1.5	-	3.0	ns
T <sub>OEM</sub>	Macrocell to global OE delay	-	1.7	-	1.7	ns
<b>I/O Standard Time Adder Delays 1.5V CMOS</b>						
T <sub>HYS15</sub>	Hysteresis input adder	-	4.0	-	6.0	ns
T <sub>OUT15</sub>	Output adder	-	0.9	-	1.5	ns
T <sub>SLEW15</sub>	Output slew rate adder	-	4.0	-	6.0	ns
<b>I/O Standard Time Adder Delays 1.8V CMOS</b>						
T <sub>HYS18</sub>	Hysteresis input adder	-	3.0	-	4.0	ns
T <sub>OUT18</sub>	Output adder	-	0	-	0	ns
T <sub>SLEW</sub>	Output slew rate adder	-	3.5	-	5.0	ns

## Internal Timing Parameters (Continued)

Symbol	Parameter <sup>(1)</sup>	-5		-7		Units
		Min.	Max.	Min.	Max.	
<b>I/O Standard Time Adder Delays 2.5V CMOS</b>						
T <sub>IN25</sub>	Standard input adder	-	0.5	-	0.6	ns
T <sub>HYS25</sub>	Hysteresis input adder	-	2.5	-	3.0	ns
T <sub>OUT25</sub>	Output adder	-	0.8	-	0.9	ns
T <sub>SLEW25</sub>	Output slew rate adder	-	4.0	-	5.0	ns
<b>I/O Standard Time Adder Delays 3.3V CMOS/TTL</b>						
T <sub>IN33</sub>	Standard input adder	-	0.5	-	0.6	ns
T <sub>HYS33</sub>	Hysteresis input adder	-	2.0	-	3.0	ns
T <sub>OUT33</sub>	Output adder	-	1.2	-	1.4	ns
T <sub>SLEW33</sub>	Output slew rate adder	-	4.0	-	5.0	ns

1. 1.5 ns input pin signal rise/fall.

## Switching Characteristics

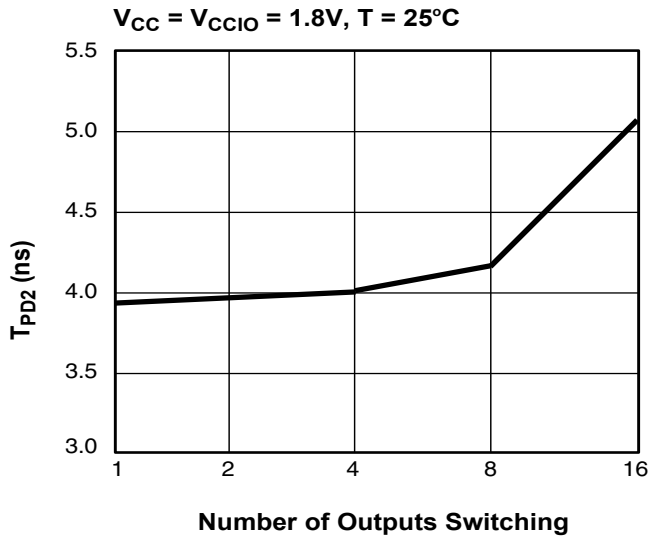

DS092\_02\_092302

Figure 2: Derating Curve for  $T_{PD}$

## Typical I/O Output Curves

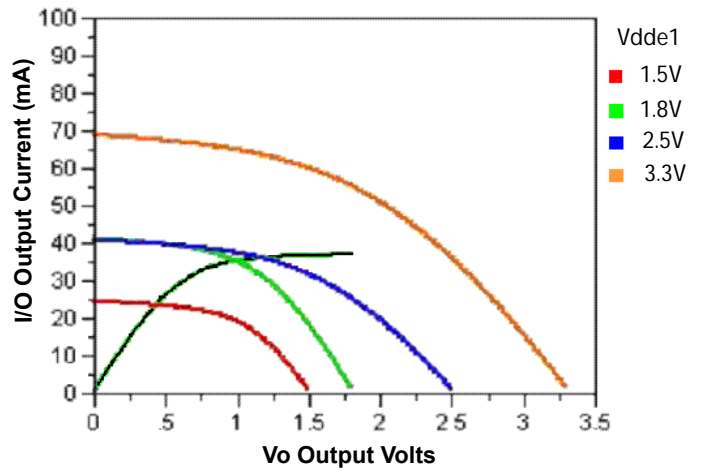
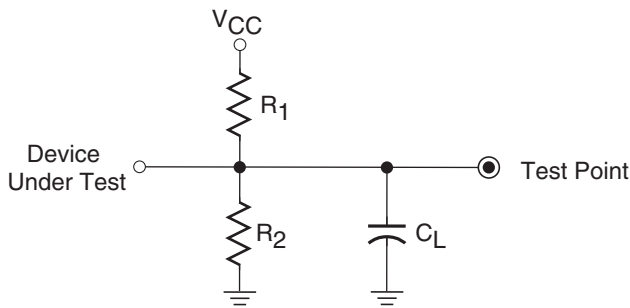

Figure 4: Typical I/O Output Curves

## AC Test Circuit



Output Type	$R_1$	$R_2$	$C_L$
LVTTL33	268 $\Omega$	235 $\Omega$	35 pF
LVC MOS33	275 $\Omega$	275 $\Omega$	35 pF
LVC MOS25	188 $\Omega$	188 $\Omega$	35 pF
LVC MOS18	112.5 $\Omega$	112.5 $\Omega$	35 pF
LVC MOS15	150 $\Omega$	150 $\Omega$	35 pF

**Notes:**

1.  $C_L$  includes test fixtures and probe capacitance.
2. 1.5 ns maximum rise/fall times on inputs.

DS311\_03\_102108

Figure 3: AC Load Circuit

## Pin Descriptions

Function Block	Macrocell	PC44 <sup>(1)</sup>	VQ44	QFG48	CP56	VQ100	I/O Banking
1	1	44	38		F1	13	Bank 2
1	2	43	37	5	E3	12	Bank 2
1	3	42	36	4	E1	11	Bank 2
1	4	-	-		-	10	Bank 2
1	5	-	-		-	9	Bank 2
1	6	-	-		-	8	Bank 2
1	7	-	-		-	7	Bank 2
1	8	-	-		-	6	Bank 2
1(GTS1)	9	40	34	2	D1	4	Bank 2
1(GTS0)	10	39	33	1	C1	3	Bank 2
1(GTS3)	11	38	32	48	A3	2	Bank 2
1(GTS2)	12	37	31	47	A2	1	Bank 2
1(GSR)	13	36	30	46	B1	99	Bank 2
1	14	-	-		A1	97	Bank 2
1	15	-	-		C3	94	Bank 2
1	16	-	-		-	92	Bank 2
2	1	1	39	6	G1	14	Bank 1
2	2	2	40	7	F3	15	Bank 1
2	3	-	-	8	-	16	Bank 1
2	4	-	-	9	-	17	Bank 1
2	5	3	41	10	H1	18	Bank 1
2	6	4	42		G3	19	Bank 1
2(GCK0)	7	5	43	11	J1	22	Bank 1
2(GCK1)	8	6	44	12	K1	23	Bank 1
2	9	-	-		K4	24	Bank 1
2(GCK2)	10	7	1	13	K2	27	Bank 1
2	11	-	-		-	28	Bank 1
2	12	8	2	14	K3	29	Bank 1
2	13	9	3	15	H3	30	Bank 1
2	14	-	-		K5	32	Bank 1
2	15	-	-		-	33	Bank 1
2	16	-	-		-	34	Bank 1

## Pin Descriptions (Continued)

Function Block	Macrocell	PC44 <sup>(1)</sup>	VQ44	QFG48	CP56	VQ100	I/O Banking
3	1	35	29	45	C4	91	Bank 2
3	2	34	28	44	A4	90	Bank 2
3	3	33	27	43	C5	89	Bank 2
3	4	-	-		A7	81	Bank 2
3	5	-	-	39	C8	79	Bank 2
3	6	29	23	38	A8	78	Bank 2
3	7	-	-		A9	77	Bank 2
3	8	-	-		-	76	Bank 2
3	9	-	-	37	A5	74	Bank 2
3	10	28	22	36	A10	72	Bank 2
3	11	27	21	35	B10	71	Bank 2
3	12	26	20	34	C10	70	Bank 2
3	13	-	-		D8	68	Bank 2
3	14	25	19	33	E8	67	Bank 2
3	15	24	18	32	D10	64	Bank 2
3	16	-	-		-	61	Bank 2
4	1	11	5	17	K6	35	Bank 1
4	2	12	6	18	H5	36	Bank 1
4	3	-	-		K7	37	Bank 1
4	4	-	-		-	39	Bank 1
4	5	-	-		H7	40	Bank 1
4	6	-	-		-	41	Bank 1
4	7	14	8	20	H8	42	Bank 1
4	8	-	-		-	43	Bank 1
4	9	-	-		-	49	Bank 1
4	10	-	-	24	K8	50	Bank 1
4	11	18	12	25	H10	52	Bank 1
4	12	-	-	26	-	53	Bank 1
4	13	19	13	27	G10	55	Bank 1
4	14	20	14	28	-	56	Bank 1
4	15	22	16		F10	58	Bank 1
4	16	-	-	30	E10	60	Bank 1

1. This is an obsolete package type. It remains here for legacy support only.
2. GTS = global output enable, GSR = global set reset, GCK = global clock.
3. GCK, GSR, and GTS pins can also be used for general purpose I/Os.

## XC2C64A Global, JTAG, Power/Ground, and No Connect Pins

Pin Type	PC44 <sup>(1)</sup>	VQ44	QFG48	CP56	VQ100
TCK	17	11	23	K10	48
TDI	15	9	21	J10	45
TDO	30	24	40	A6	83
TMS	16	10	22	K9	47
V <sub>CCAUX</sub> (JTAG supply voltage)	41	35	3	D3	5
Power internal (V <sub>CC</sub> )	21	15	29	G8	26,57
Power bank 1 I/O (V <sub>CCIO1</sub> )	13	7	19	H6	38, 51
Power bank 2 I/O (V <sub>CCIO2</sub> )	32	26	42	C6	88, 98
Ground	10, 23, 31	4,17,25	16, 31, 41	H4, F8, C7	21, 31, 62, 69, 84,100
No connects					20, 25, 44, 46, 54, 59, 63, 65, 66, 73, 75, 80, 82, 85, 86, 87, 93, 95, 96
Total user I/O	33	33	37	45	64

1. This is an obsolete package type. It remains here for legacy support only.

## Ordering Information

Device Ordering No. and Part Marking No.	Pin/Ball Spacing	$\theta_{JA}$ (°C/Watt)	$\theta_{JC}$ (°C/Watt)	Package Type	Package Body Dimensions	I/O	Comm(C) Ind. (I) <sup>(1)</sup>
XC2C64A-5QFG48C	0.5mm	31.2	21.2	Quad Flat No Lead	7mm x 7mm	37	C
XC2C64A-7QFG48C	0.5mm	31.2	21.2	Quad Flat No Lead	7mm x 7mm	37	C
XC2C64A-5VQ44C	0.8mm	46.6	8.2	Very Thin Quad Flat Pack	10mm x 10mm	33	C
XC2C64A-7VQ44C	0.8mm	46.6	8.2	Very Thin Quad Flat Pack	10mm x 10mm	33	C
XC2C64A-5CP56C	0.5mm	65.0	15.0	Chip Scale Package	6mm x 6mm	45	C
XC2C64A-7CP56C	0.5mm	65.0	15.0	Chip Scale Package	6mm x 6mm	45	C
XC2C64A-5VQ100C	0.5mm	53.2	14.6	Very Thin Quad Flat Pack	14mm x 14mm	64	C
XC2C64A-7VQ100C	0.5mm	53.2	14.6	Very Thin Quad Flat Pack	14mm x 14mm	64	C
XC2C64A-5VQG44C	0.8mm	46.6	8.2	Very Thin Quad Flat Pack; Pb-free	10mm x 10mm	33	C
XC2C64A-7VQG44C	0.8mm	46.6	8.2	Very Thin Quad Flat Pack; Pb-free	10mm x 10mm	33	C
XC2C64A-5CPG56C	0.5mm	65.0	15.0	Chip Scale Package; Pb-free	6mm x 6mm	45	C
XC2C64A-7CPG56C	0.5mm	65.0	15.0	Chip Scale Package; Pb-free	6mm x 6mm	45	C
XC2C64A-5VQG100C	0.5mm	53.2	14.6	Very Thin Quad Flat Pack; Pb-free	14mm x 14mm	64	C
XC2C64A-7VQG100C	0.5mm	53.2	14.6	Very Thin Quad Flat Pack; Pb-free	14mm x 14mm	64	C
XC2C64A-7VQ44I	0.8mm	46.6	8.2	Very Thin Quad Flat Pack	10mm x 10mm	33	I
XC2C64A-7QFG48I	0.5mm	31.2	21.2	Quad Flat No Lead; Pb-free	7mm x 7mm	37	I
XC2C64A-7CP56I	0.5mm	65.0	15.0	Chip Scale Package	6mm x 6mm	45	I
XC2C64A-7VQ100I	0.5mm	53.2	14.6	Very Thin Quad Flat Pack	14mm x 14mm	64	I

Device Ordering No. and Part Marking No.	Pin/Ball Spacing	$\theta_{JA}$ (°C/Watt)	$\theta_{JC}$ (°C/Watt)	Package Type	Package Body Dimensions	I/O	Comm(C) Ind. (I) <sup>(1)</sup>
XC2C64A-7VQG44I	0.8mm	46.6	8.2	Very Thin Quad Flat Pack; Pb-free	10mm x 10mm	33	I
XC2C64A-7CPG56I	0.5mm	65.0	15.0	Chip Scale Package; Pb-free	6mm x 6mm	45	I
XC2C64A-7VQG100I	0.5mm	53.2	14.6	Very Thin Quad Flat Pack; Pb-free	14mm x 14mm	64	I

**Notes:**

1. C = Commercial (T<sub>A</sub> = 0°C to +70°C); I = Industrial (T<sub>A</sub> = -40°C to +85°C).

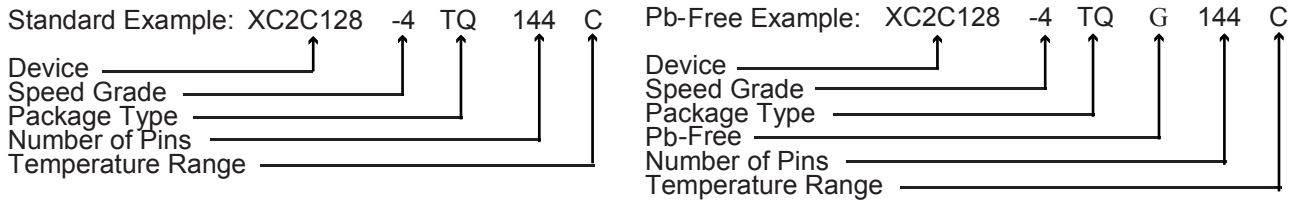

## Device Part Marking

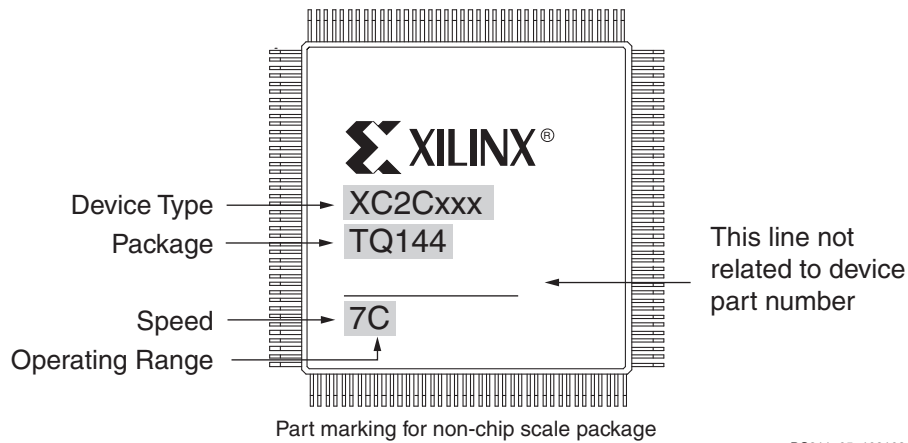

DS311\_05\_102108

Figure 5: Sample Package with Part Marking

**Note:** Due to the small size of chip scale and quad flat no lead packages, the complete ordering part number cannot be included on the package marking. Part marking on chip scale and quad flat no lead packages by line are:

1. X (Xilinx logo) then truncated part number
2. Not related to device part number
3. Not related to device part number
4. Device code, speed, operating temperature, three digits not related to device part number. Device codes: C3 = CP56, C4 = CPG56, Q2 = QFG48.



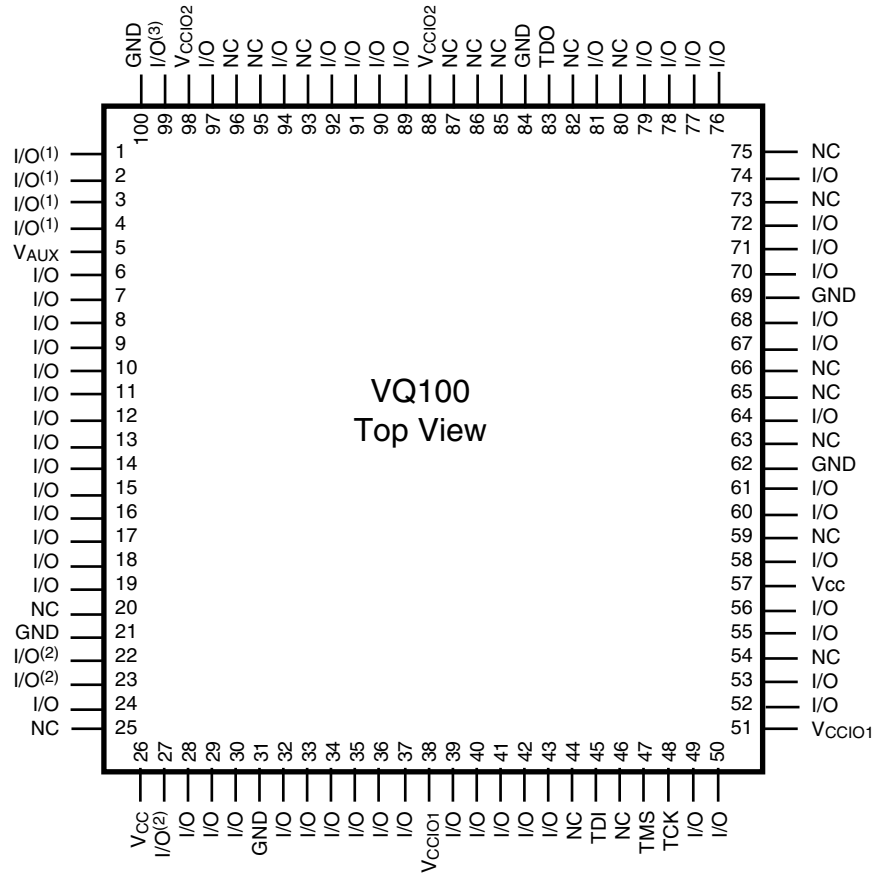

- (1) - Global Output Enable
- (2) - Global Clock
- (3) - Global Set/Reset

Figure 12: VQ100 Package

## Warranty Disclaimer

THESE PRODUCTS ARE SUBJECT TO THE TERMS OF THE XILINX LIMITED WARRANTY WHICH CAN BE VIEWED AT <http://www.xilinx.com/warranty.htm>. THIS LIMITED WARRANTY DOES NOT EXTEND TO ANY USE OF THE PRODUCTS IN AN APPLICATION OR ENVIRONMENT THAT IS NOT WITHIN THE SPECIFICATIONS STATED ON THE THEN-CURRENT XILINX DATA SHEET FOR THE PRODUCTS. PRODUCTS ARE NOT DESIGNED TO BE FAIL-SAFE AND ARE NOT WARRANTED FOR USE IN APPLICATIONS THAT POSE A RISK OF PHYSICAL HARM OR LOSS OF LIFE. USE OF PRODUCTS IN SUCH APPLICATIONS IS FULLY AT THE RISK OF CUSTOMER SUBJECT TO APPLICABLE LAWS AND REGULATIONS.

## Additional Information

Additional information is available for the following CoolRunner-II CPLD topics at

[www.xilinx.com/support/documentation/coolrunner-ii.htm](http://www.xilinx.com/support/documentation/coolrunner-ii.htm):

- Device pinouts in the density specific data sheets
- Termination, power sequencing, voltage thresholds, and slew rate data in the CPLD IO User Guide

- Reliability data in the Device Reliability Report
- Packaging thermal and electrical data in the Device Package User Guide

Package drawings and dimensions are available at:

[www.xilinx.com/support/documentation/package\\_specifications.htm](http://www.xilinx.com/support/documentation/package_specifications.htm)

## Revision History

The following table shows the revision history for this document.

Date	Version	Revision
5/15/04	1.0	Initial Xilinx release.
8/30/04	1.1	Pb-free documentation
10/01/04	1.2	Add Asynchronous Preset/Reset Pulse Width specification to AC Electrical Characteristics.
11/08/04	1.3	Product Release. No change to documentation.
11/29/04	1.4	Change to QFG package drawing (Figure 8). Pin 29 relabelled.
12/14/04	1.5	Changes to Figure 4, Typical I/O Output Curves; Changes to $t_{OUT25}$ and $t_{OUT33}$ , Internal Timing Parameters, page 8.
01/18/05	1.6	Changes to $I_{CCSB}$ , $f_{TOGGLE}$ , $t_{PSU1}$ , $t_{PSU2}$ , $t_{PHD}$ , $t_{CW}$ , $t_{SLEW25}$ , and $t_{SLEW33}$
03/07/05	1.7	Format change to specifications $I_{IL}$ and $I_{IH}$ , page 3. Improvement to pin-to-pin logic delay, page 1. Modifications to Table 1, IOSTANDARDS.
06/28/05	1.8	Move to Product Specification. Change to $T_{IN25}$ , $T_{OUT25}$ , $T_{IN33}$ , and $T_{OUT33}$ .
01/30/06	1.9	Modified footnote 1 from AC Specifications Table to remove incorrect equation.
03/20/06	2.0	Add Warranty Disclaimer. Add note to Pin Descriptions that GCK, GSR, and GTS pins can also be used for general purpose I/O.
02/15/07	2.1	Change to $V_{IH}$ specification for 2.5V and 1.8V LVCMOS. Change $T_F$ specification on -7 speed grade from 2.0 to 3.0 ns.
03/08/07	2.2	Fixed typo in note for $V_{IL}$ for LVCMOS18; removed note for $V_{IL}$ for LVCMOS33.
11/19/08	2.3	Added note to Pin Description tables to indicate the PC44 packages are obsolete. Removed part numbers for devices in PC44 packages the Features section and from the ordering information. See Product Discontinuation Notice <a href="#">xcn07022.pdf</a> .

## Looking for pricing, stock, or lifecycle information?

Click below to explore more details on WIN SOURCE:

 [View XC2C64A-7CPG56I on WIN SOURCE](#)

 [Amd Information](#)

## Optimize Your Supply Chain with WIN SOURCE Solutions

-  Global Sourcing Solution
-  Obsolete Management
-  Cost Control Management
-  Shortage Management
-  Alternative Solution
-  Excess Inventory Management