

DIO7552/7553

Precision Adjustable Current-Limited Power Distribution Switches

Features

- 70 mΩ (typ) high-side MOSFET
- 2.31 A maximum continuous load current
- ±10% current-limit accuracy at 1 A typically
- Adjustable current limit:
400 mA ~ 2.57 A (typ)
- Operating range: 2.7 V to 5.5 V
- 70 μA (typ) quiescent current
- 2 μs fast overcurrent response typically
- Reverse input-output voltage protection
- ±6 kV HBM ESD protection
- Green package: SOT23-6 and DFN2*2-6 is pin compatible

Application

- USB ports & USB hubs
- Digital TVs
- Set-top boxes
- VOIP phones
- Short circuit protections

Descriptions

The DIO7552/7553 is power distribution switches that intended for applications where precision current limiting is required or heavy capacitive loads and short circuits are encountered. The device provides up to 2.31 A of continuous load current. When the voltage is higher than the maximum voltage of 5%, the chip could be maintained for at least 10 ms without damage.

A programmable current-limit threshold is offered between 400 mA and 2.57 A (typ) via an external resistor. Current-limit accuracy is ±10% at 1 A. The power-switch rise and fall times are controlled to minimize current surges during turn on/off. A constant-current mode is used when the output load exceeds the current-limit threshold.

The DIO7552/7553 limits the output current to a safe level by using a constant-current mode when the output load exceeds the current-limit threshold. An internal reverse voltage comparator disables the power switch when the output voltage is driven higher than the input to protect devices on the input side.

Block Diagram

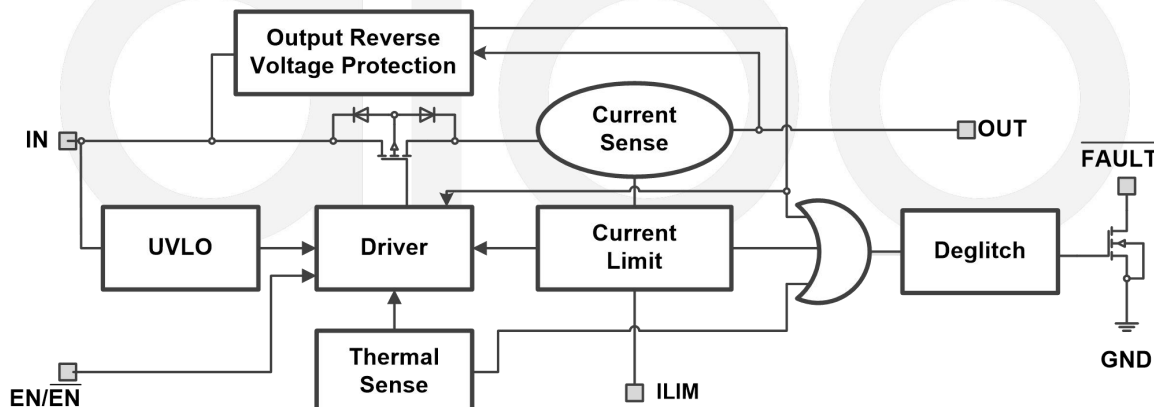
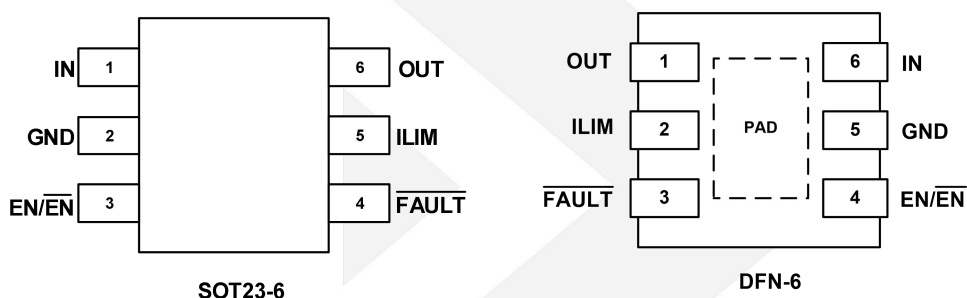

Figure 1. Functional block diagram

Ordering Information

Ordering Part No.	Top Marking	MSL	RoHS	T _A	Package	
DIO7552ST6	YW52	3	Green	-40 to 85°C	SOT23-6	Tape & Reel, 3000
DIO7553ST6	YW53	3	Green	-40 to 85°C	SOT23-6	Tape & Reel, 3000
DIO7552CD6	D52	3	Green	-40 to 85°C	DFN2*2-6	Tape & Reel, 3000
DIO7553CD6	D53	3	Green	-40 to 85°C	DFN2*2-6	Tape & Reel, 3000

Pin Assignment



\overline{EN} = Active low for the DIO7552, EN = Active high for the DIO7553

Figure 2. Pin assignment

Pin Description

Name	Function
IN	Input voltage; connect a 0.1 μ F or greater ceramic capacitor from IN to GND as close to the IC as possible.
GND	Ground pin.
EN	Enable input, logic high turns on power switch.
\overline{EN}	Enable input, logic low turns on power switch.
\overline{FAULT}	Active-low open-drain output, asserted during over current, over-temperature, or reverse-voltage conditions.
ILIM	External resistor used to set current-limit threshold; recommended $10\text{ k}\Omega \leq R_{ILIM} \leq 64\text{ k}\Omega$.
OUT	Power-switch output.

Absolute Maximum Ratings

Stresses beyond those listed under the Absolute Maximum Rating table may cause permanent damage to the device. These are stress ratings only and functional operation of the device at these or any other condition beyond those indicated in the operational sections of the specifications is not implied. Exposure to absolute maximum rating conditions for extended periods may affect device reliability.

Symbol	Parameter		Rating	Unit
V _{IN}	Operation voltage (with respect to GND)		-0.3 to 6.0	V
	Other inputs		-0.3 to 6.0	
V _{FLG}	Fault flag voltage		-0.3 to 6.0	V
I _{FLG}	Fault flag current		10	mA
R _{θJA}	Package thermal resistance	SOT23-6	190	°C/W
R _{θJA}		DFN2*2-6	140	°C/W
T _J	Maximum junction temperature		150	°C
T _A	Operating temperature		-40 to 85	°C
T _{STG}	Storage temperature		-65 to 150	°C
T _L	Lead temperature rating		300	°C
ESD	Electrostatic discharge susceptibility	HBM (human body mode)	±6	kV

Recommended Operating Conditions

Recommended Operating Conditions table defines the conditions for actual device operation. Recommended operating conditions are specified to ensure optimal performance to the datasheet specifications. DIOO does not recommend exceeding them or designing to absolute maximum ratings.

Symbol	Parameter	Rating	Unit
V _{IN}	Operation voltage	2.7 ~ 5.5	V
	Terminal voltage at all other pins	0 ~ 5.5	V
T _J	Junction temperature range	-40 to 125	°C
T _A	Ambient temperature range	-40 to 85	°C

Electrical Characteristics

Typical value: $T_A = 25^\circ\text{C}$, $V_{IN} = 5\text{ V}$, unless otherwise specified.

Symbol	Parameters	Conditions		Min	Typ	Max	Unit
V_{IN}	Operation voltage			2.7		5.5	V
$R_{DS(ON)}$	On resistance	$V_{IN} = 5\text{ V}$	$T_A = 25^\circ\text{C}$		70	100	m Ω
			$-40^\circ\text{C} \leq T_A \leq 85^\circ\text{C}$			130	m Ω
I_{OS}	Over current limit	$R_{SET} = 10\text{ k}\Omega$	$-40^\circ\text{C} \leq T_A \leq 85^\circ\text{C}$	2.31	2.57	3.08	A
		$R_{SET} = 15\text{ k}\Omega$	$-40^\circ\text{C} \leq T_A \leq 85^\circ\text{C}$	1.54	1.7	1.96	A
		$R_{SET} = 20\text{ k}\Omega$	$-40^\circ\text{C} \leq T_A \leq 85^\circ\text{C}$	1.11	1.31	1.51	A
		$R_{SET} = 24\text{ k}\Omega$	$-40^\circ\text{C} \leq T_A \leq 85^\circ\text{C}$	0.97	1.07	1.18	A
I_Q	Quiescent supply current	Open load, IC enabled.			70		μA
t_R	Output turn-on rise time	$R_L = 100\ \Omega$, 90% settling			0.4		ms
t_F	Output turn-off time	$R_L = 100\ \Omega$, 10% settling			0.3		ms
$V_{EN(H)}$	EN input threshold-high V_{IH}			1.4			V
$V_{EN(L)}$	EN input threshold-low V_{IL}					0.4	V
t_{ON}	EN turn-on time	$C_L = 1\ \mu\text{F}$, $R_L = 100\ \Omega$.			270		μs
t_{OFF}	EN turn-off time	$C_L = 1\ \mu\text{F}$, $R_L = 100\ \Omega$.			7		μs
	FLAG deglitch time	FLAG assertion or desertion		4	8	15	ms
	Output reverse voltage deglitch time			2.5	4	7	ms
I_{SHDN}	Shutdown input current	Open load, IC disabled.				1	μA
T_{SD}	Thermal shutdown				140		$^\circ\text{C}$
	Thermal limit hysteresis				20		$^\circ\text{C}$

Note:

(1) Specifications subject to change without notice.



Typical Application

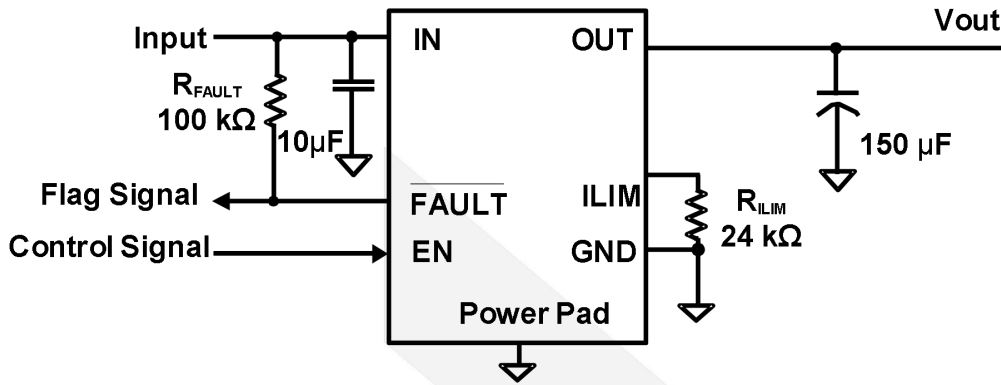

Figure 3. Typical characteristics reference schematic in SOT23-6 package

Typical Performance Characteristic

Typical value: $T_A = 25^\circ\text{C}$, $V_{IN} = 5\text{ V}$, unless otherwise specified.

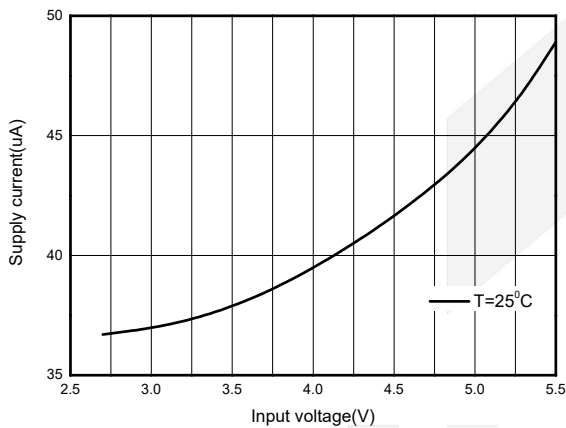

Figure 4. I_Q vs. Input voltage

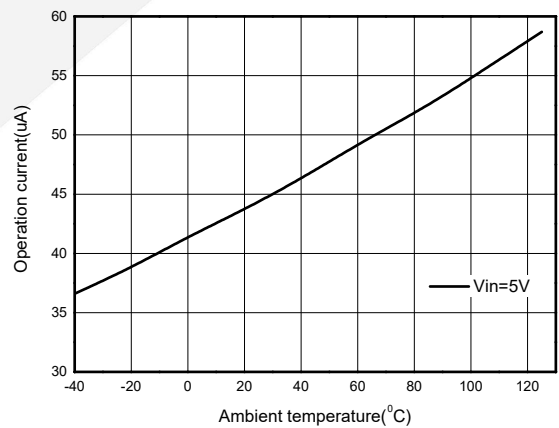

Figure 5. I_Q vs. Ambient temperature

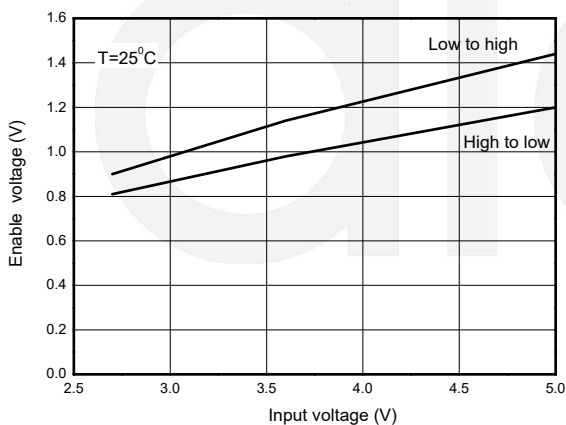

Figure 6. Enable voltage vs. Input voltage

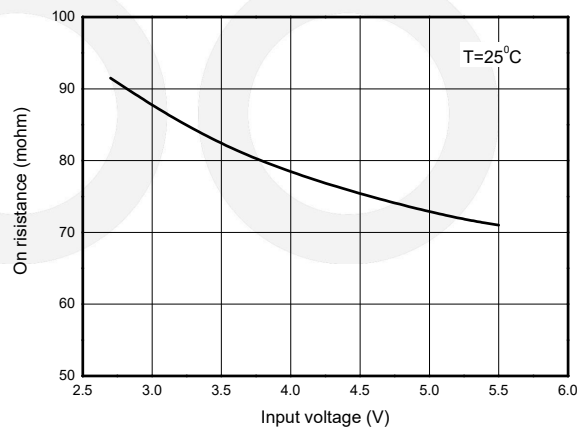

Figure 7. On resistance vs. Input voltage

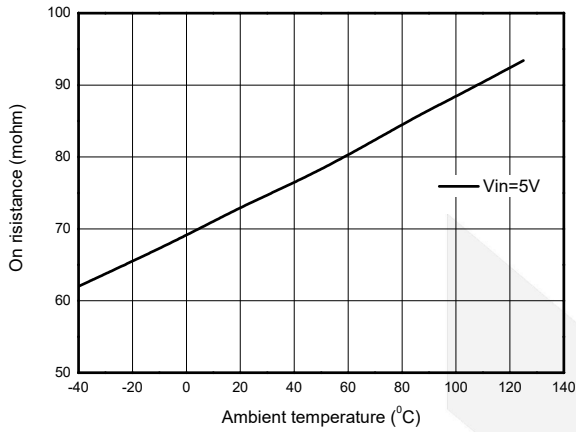

Figure 8. On resistance vs. Ambient temperature

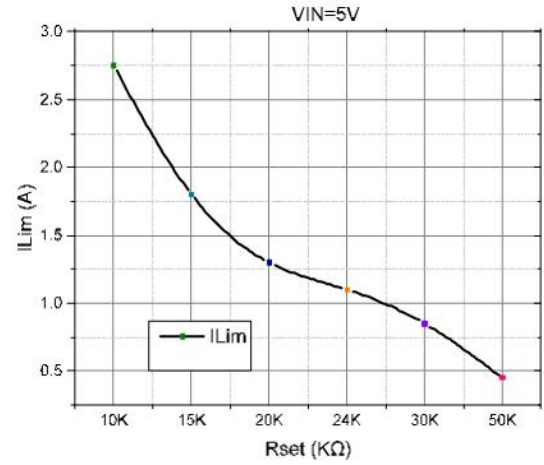
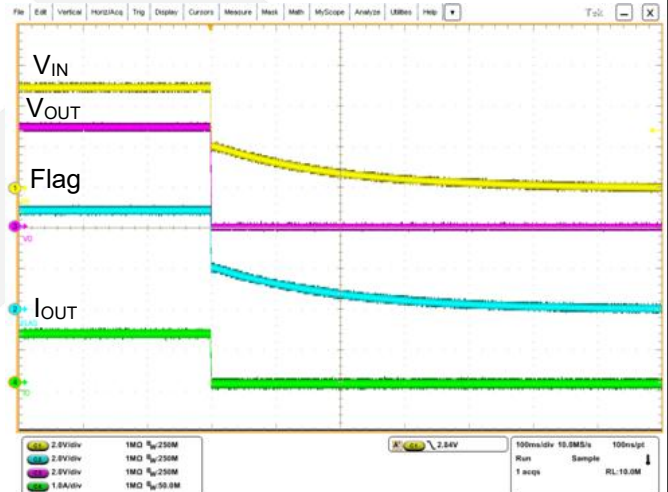

Figure 9. R_{SET} vs. I_{os}



(EN = V_{IN}, R_{OUT} = 3.9 Ω, V_{IN} = 0 ↑ 5V)

Figure 10. V_{IN} Start-up



(EN = V_{IN}, R_{OUT} = 3.9 Ω, V_{IN} = 5V ↓ 0)

Figure 11. V_{IN} Shut-down

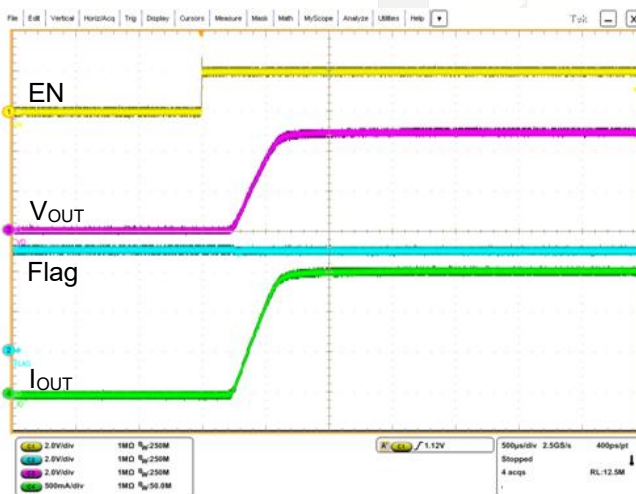

(V_{IN} = 5 V, R_{OUT} = 3.3 Ω, EN = 0 ↑ 5 V)

Figure 12. EN Start-up



(V_{IN} = 5 V, R_{OUT} = 3.3 Ω, EN = 5 V ↓ 0)

Figure 13. EN Shut-down

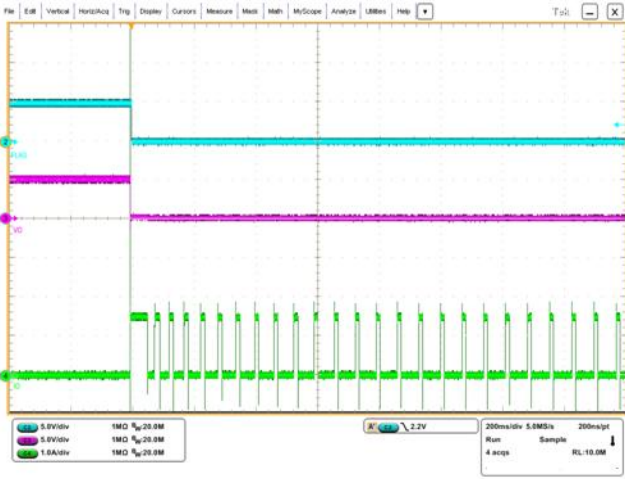

(no load, $V_{EN} = V_{IN}$, $V_{OUT} \rightarrow 0$)
Figure 14. Short protection

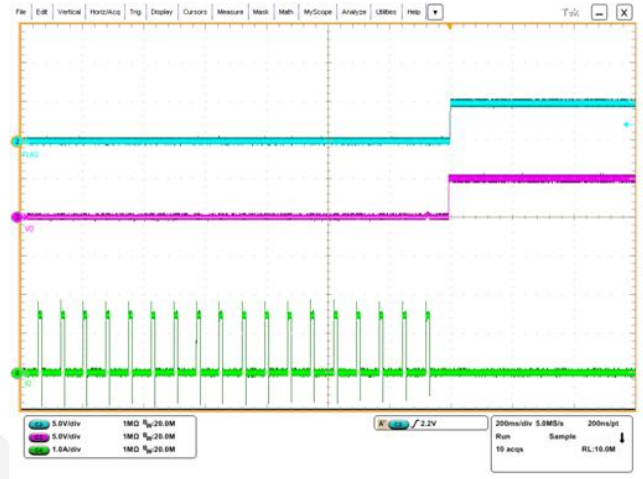

($V_{EN} = V_{IN} = 5\text{ V}$, $V_{OUT} \rightarrow 0$)
Figure 15. Short recovery

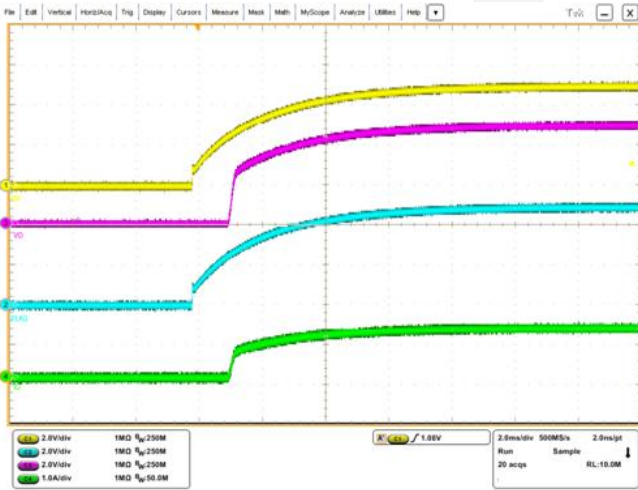

($V_{IN} = 5\text{ V}$, $V_{EN} = V_{IN}$, $R_{OUT} = 3.9\ \Omega$, $V_{IN} \rightarrow 5\text{ V}$)
Figure 16. UVLO

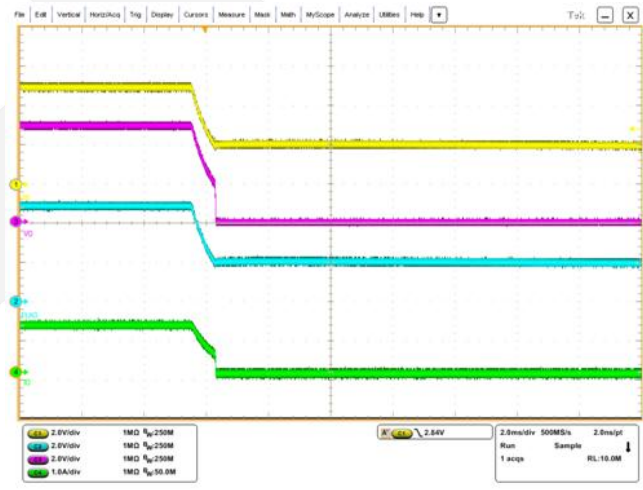

($V_{IN} = 5\text{ V}$, $V_{EN} = V_{IN}$, $R_{OUT} = 3.9\ \Omega$, $V_{IN} \rightarrow 0\text{ V}$)
Figure 17. UVLO

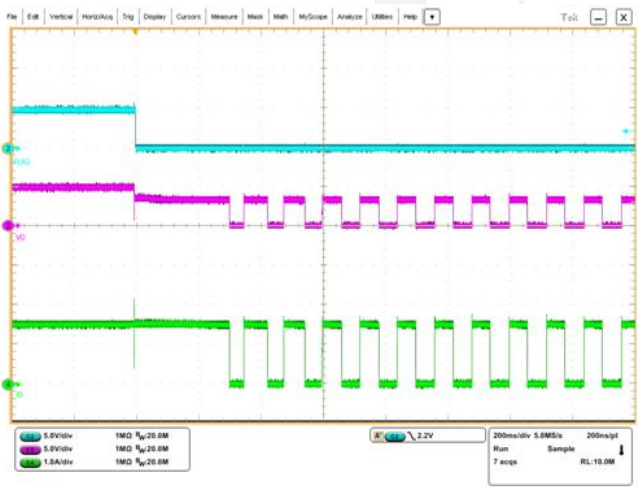

($V_{IN} = 5\text{ V}$, $V_{EN} = V_{IN}$, $R_{OUT} = 3.3 \rightarrow 1.8\ \Omega$)
Figure 18. Heavy load to overload

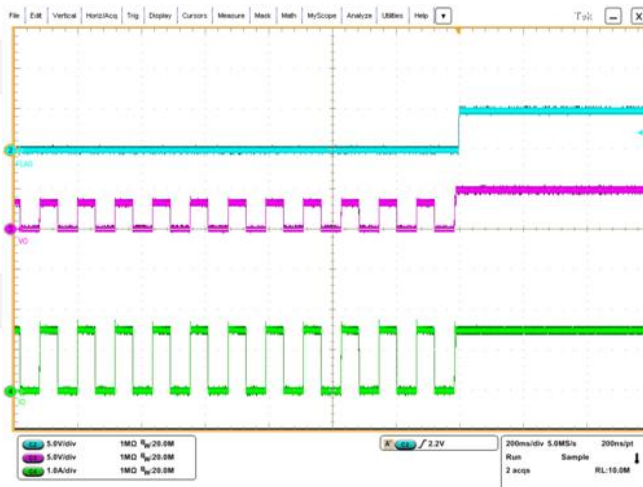

($V_{IN} = 5\text{ V}$, $V_{EN} = V_{IN}$, $R_{OUT} = 1.8 \rightarrow 3.3\ \Omega$)
Figure 19. Overload to heavy load recovery

Application Information

Operation information

The DIO7552/7553 is a current limited P-channel MOSFET power switch with overcurrent and over-temperature protection. There is no body diode across the drain and the source of the MOSFET. It prevents the current flow from the output to the input after the chip is disabled.

Over current protection

When the over current condition is detected, the switch is regulated to achieve constant output current. If the over current condition lasts for a long time, and results in a junction temperature over 140°C, the switch will be shutdown. As soon as the junction temperature drops to 120°C, the part will restart.

Reverse-voltage protection

The reverse-voltage protection feature turns off the P-channel MOSFET whenever the output voltage exceeds the input voltage by 135 mV (typ) for 4 ms (typ). A reverse current of $(V_{OUT} - V_{IN}) / R_{DS(on)}$ will be present when this occurs. This prevents damage to devices on the input side of the DIO7552/53 by preventing significant current from sinking into the input capacitance. The DIO7552/53 devices allow the P-channel MOSFET to turn on as soon as the output voltage goes below the input voltage for the same 4 ms deglitch time.

Supply filter capacitor

In order to prevent the input voltage from dropping during hot-plug condition, a 10 μF ceramic capacitor from V_{IN} to GND is strongly recommended. However, higher capacitance could help reduce the voltage drop. Further more, an output short will cause ringing on the input without the input capacitor. It could destroy the internal circuitry when the input transient voltage exceeds the absolute maximum supply voltage even for a short duration.

Current limiting setting

Current limit is programmable to protect the power source from overcurrent and short circuit conditions. Connect a resistor R_{SET} from I_{SET} pin to GND to program the current limit:

$$I_{OS} (A) = 25752/R_{set} (\Omega)$$

The minimum current limit is 0.4 A. Current limit beyond 2.57 A is not recommended.

Physical Dimensions: SOT-23-6

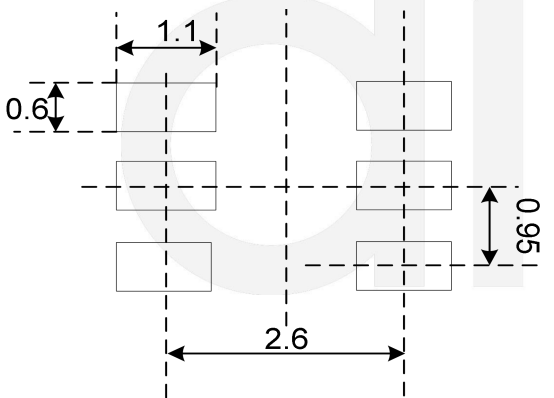
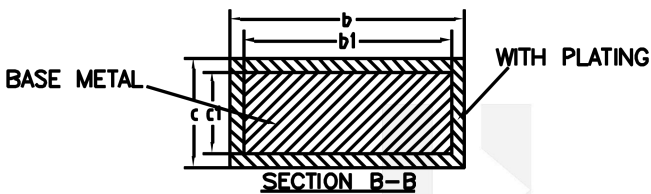
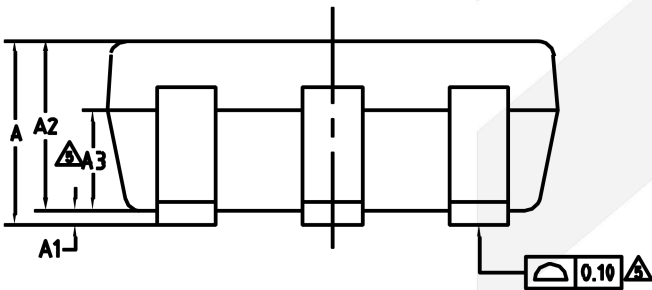
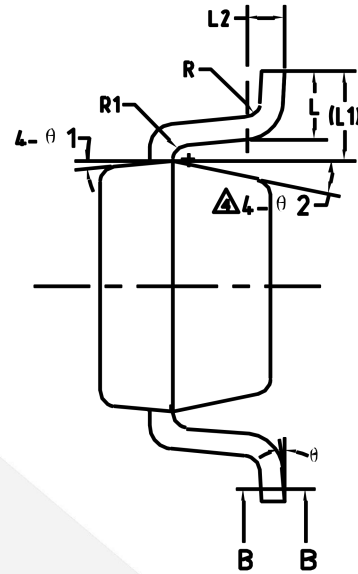
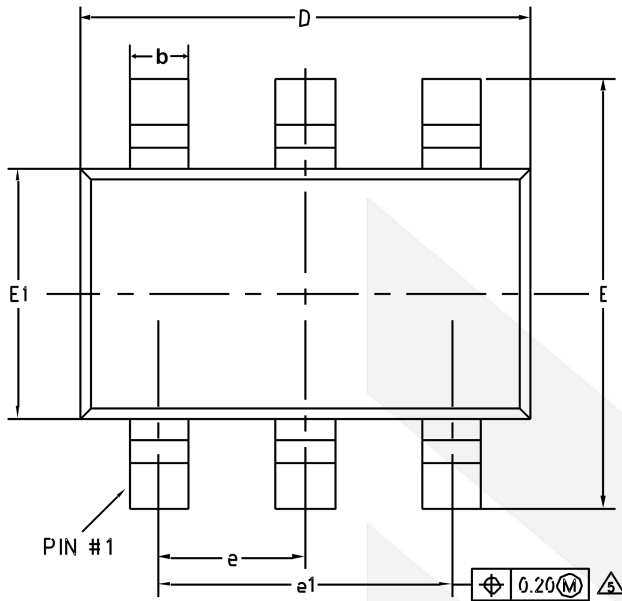

RECOMMENDED LAND PATTERN

Common Dimensions (Units of Measure = Millimeter)			
Symbol	Min	Nom	Max
A	-	-	1.25
A1	0	-	0.15
A2	1.00	1.10	1.20
A3	0.60	0.65	0.70
b	0.36	-	0.50
b1	0.36	0.38	0.45
c	0.14	-	0.20
c1	0.14	0.15	0.16
D	2.826	2.926	3.026
E	2.60	2.80	3.00
E1	1.526	1.626	1.726
e	0.90	0.95	1.00
e1	1.80	1.90	2.00
L	0.35	0.45	0.60
L1	0.59REF		
L2	0.25BSC		
R	0.10	-	-
R1	0.10	-	0.20
θ	0°	-	8°
θ1	3°	5°	7°
θ2	6°	-	14°

Physical Dimensions: DFN2*2-6

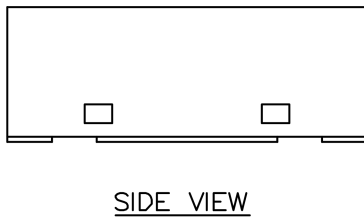
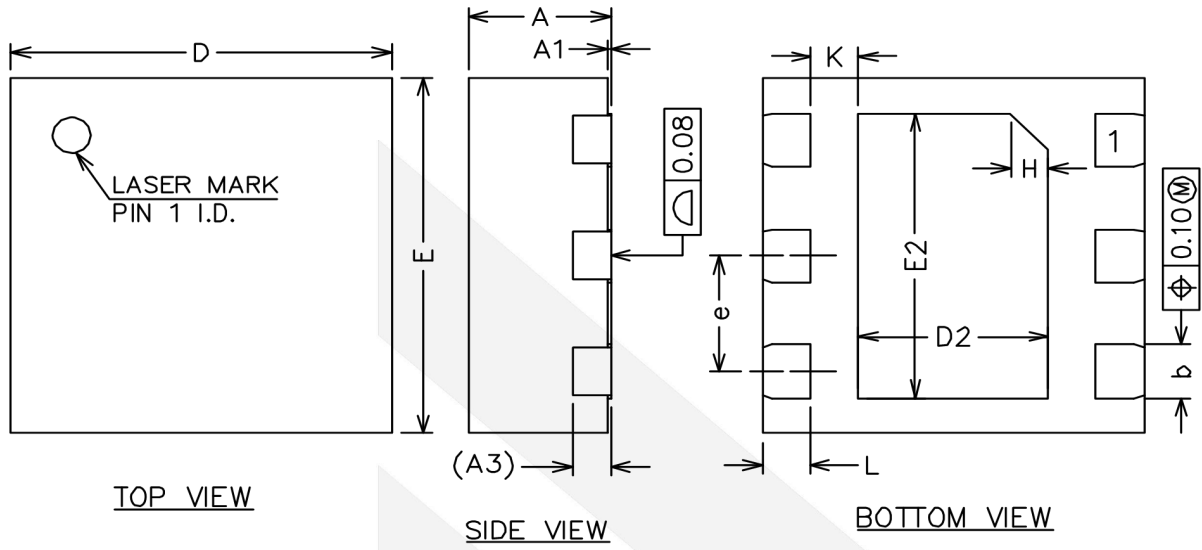

Common Dimensions (Units of Measure = Millimeter)			
Symbol	Min	Nom	Max
A	0.70	0.75	0.80
A1	0	0.02	0.05
A3	0.20 REF		
b	0.25	0.30	0.35
D	1.90	2.00	2.10
E	1.90	2.00	2.10
D2	0.90	1.00	1.10
E2	1.50	1.60	1.70
e	0.55	0.65	0.75
K	0.15	0.25	0.35
L	0.20	0.25	0.30
H	0.20 REF		

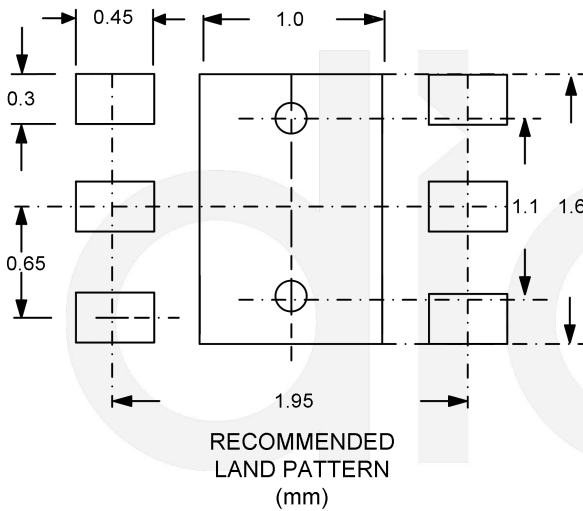

CONTACT US



Dioo is a professional design and sales corporation for high-quality and performance analog semiconductors. The company focuses on industry markets, such as cell phones, handheld products, laptops, medical equipment, and so on. Dioo's product families include analog signal processing and amplifying, LED drivers, and charger ICs. Go to <http://www.dioo.com> for a complete list of Dioo product families.

For additional product information or full datasheet, please contact our sales department or representatives.







Looking for pricing, stock, or lifecycle information?

Click below to explore more details on WIN SOURCE:

-  [View DIO7553CD6 on WIN SOURCE](#)
-  [dioo Information](#)

Optimize Your Supply Chain with WIN SOURCE Solutions

-  Global Sourcing Solution
-  Obsolete Management
-  Cost Control Management
-  Shortage Management
-  Alternative Solution
-  Excess Inventory Management