

Product Overview

The Qorvo TGA2535-SM is a X-Band Packaged Power Amplifier. The TGA2535-SM operates from 10 to 12 GHz and is designed using Qorvo' power pHEMT production process.

The TGA2535-SM typically provides 43dBm of TOI at 20dBm Pout/Tone, 33 dBm of output power at 1dB gain compression, and the small signal gain is 24 dB.

The TGA2535-SM is available in a low-cost, surface mount 24 lead 5x5 QFN package and is ideally suited for Point-to-Point Radio, and X-Band Communications.

Lead-free and RoHS compliant

Evaluation Boards are available upon request.

Functional Block Diagram

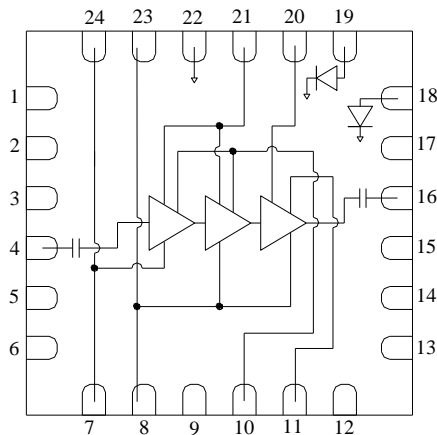

Pin Configuration

Pin #	Symbol
1, 2, 3, 5, 6, 9, 12, 13, 14, 15, 17	N/C
4	RF IN
7, 8, 23, 24	Vg
16	RF OUT
10, 11, 20, 21	Vd
18	Vref
19	Vdet
22	GND

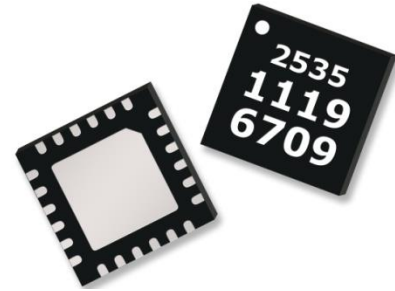

24 Pin 5x5mm QFN Package

Key Features

- Frequency Range: 10 – 12 GHz
- TOI: 43 dBm
- Power: 34.5 dBm Psat, 33 dBm P1dB
- Gain: 24 dB
- Return Loss: 15 dB
- Integrated Power Detector
- Bias: Vd = 6 V, Id = 1.3 A, Vg = -0.55 V Typical
- Package Dimensions: 5.0 x 5.0 x 0.85 mm

Applications

- Point-to-Point Radio
- X-Band Communications

Ordering Information

Part No.	Description
TGA2535-SM T/R	7" Reel with 500 pieces
TGA2535-SM Eval Board	Evaluation Board

Absolute Maximum Ratings

Parameter	Rating
Drain Voltage, Vd	+8 V
Gate Voltage, Vg	-3 to 0 V
Drain Current, Id	2.24 A
Gate Current, Ig	-11 to 90 mA
Power Dissipation, Pdiss	17.9 W
RF Input Power, CW, 50 Ω, T=+25 °C	+27 dBm
Channel Temperature, Tch	200 °C
Mounting Temperature	260 °C
Storage Temperature	-40 to 150 °C

Exceeding any one or a combination of the Absolute Maximum Rating conditions may cause permanent damage to the device.

Recommended Operating Conditions

Parameter	Min	Typ	Max	Units
Vd		6		V
Id		1.3		A
Id_drive (Under RF Drive)		1.6		A
Vg		-0.55		V

Electrical specifications are measured at specified test conditions. Specifications are not guaranteed over all recommended operating conditions. Application of conditions to the device outside the Recommended Operating Conditions may reduce device reliability and performance.

Electrical Specifications

Parameter	Min	Typical	Max	Units
Operational Frequency Range	10.0		12.0	GHz
Gain	20.5	24		dB
Input Return Loss		-15	-10	dB
Output Return Loss		-15	-12	dB
Output Power @ Saturation	33	34.5		dBm
Output Power @ 1 dB Gain Compression	31.5	33		dBm
Output TOI @ Pout/Tone = 20 dBm	41	43		dBm
Noise Figure		10		dB
Gain Temperature Coefficient		-0.031		dB/°C
Power Temperature Coefficient		-0.004		dBm/°C

Notes:

1. Test conditions unless otherwise noted: 25 °C, V_d = +6.0 V, I_d = 1.3 A, V_g = -0.55 V Typical.

Thermal and Reliability Information

Parameter	Condition	Rating
Thermal Resistance, θ_{JC} , measured to back of package	Tbase = 85 °C	$\theta_{JC} = 5.77 \text{ }^\circ\text{C/W}$
Channel Temperature (Tch), and Median Lifetime (Tm)	Tbase = 85 °C, Vd = 6 V, Id = 1.3 A, Pdiss = 7.8 W	Tch = 130 °C Tm = 5.9 E+6 Hours
Channel Temperature (Tch), and Median Lifetime (Tm) Under RF Drive	Tbase = 85 °C, Vd = 6 V, Id = 1.6 A, Pout = 34.5 dBm, Pdiss = 6.78 W	Tch = 124 °C Tm = 1.0 E+7 Hours

Median Lifetime

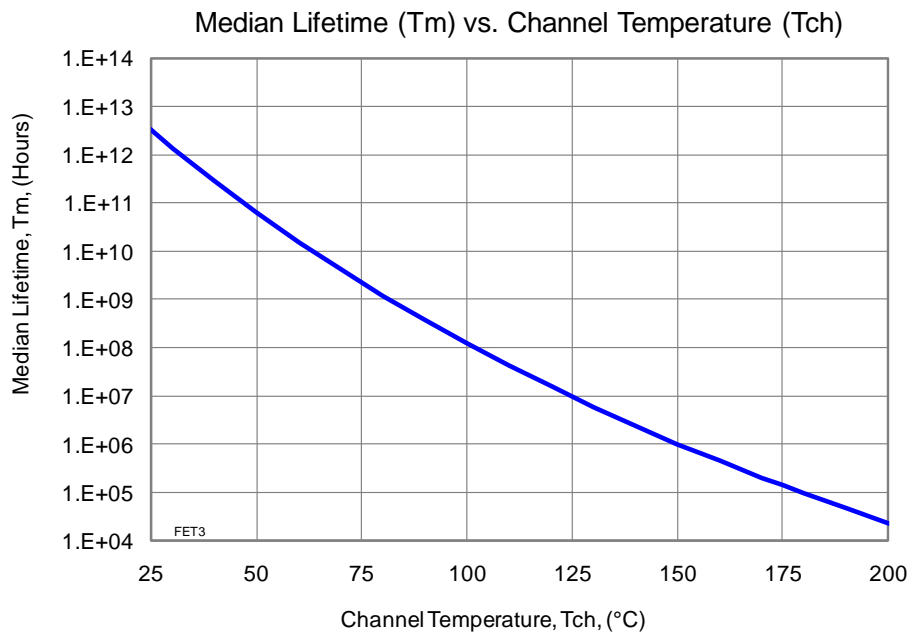

Performance Plots

Test conditions unless otherwise noted: 25 °C, $V_d = +6.0$ V, $I_d = 1.3$ A, $V_g = -0.55$ V Typical, +25 °C.

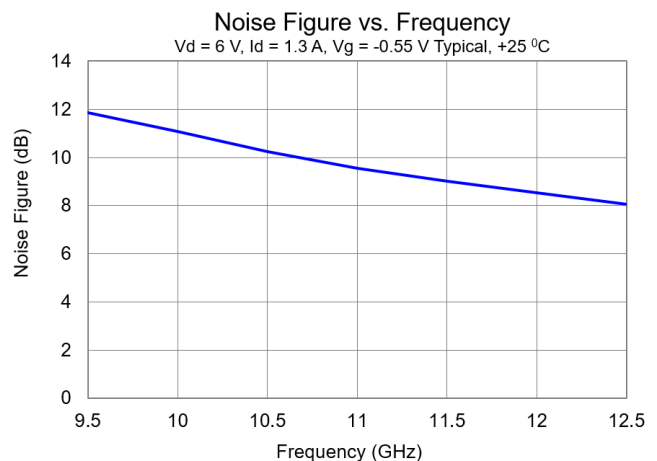
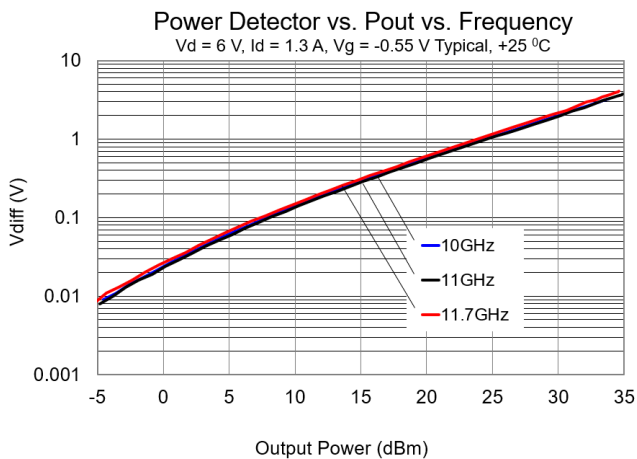
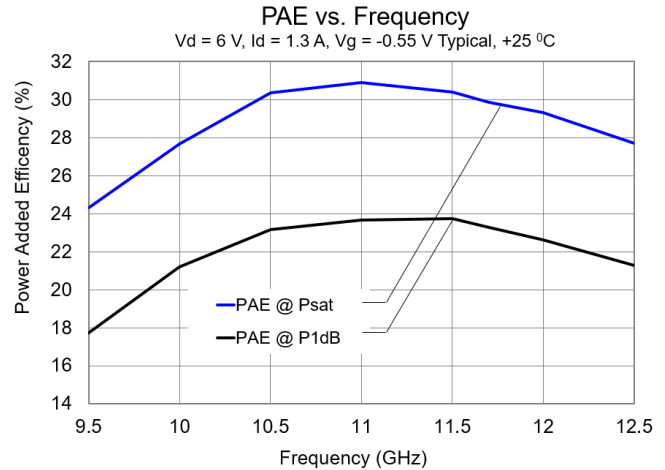
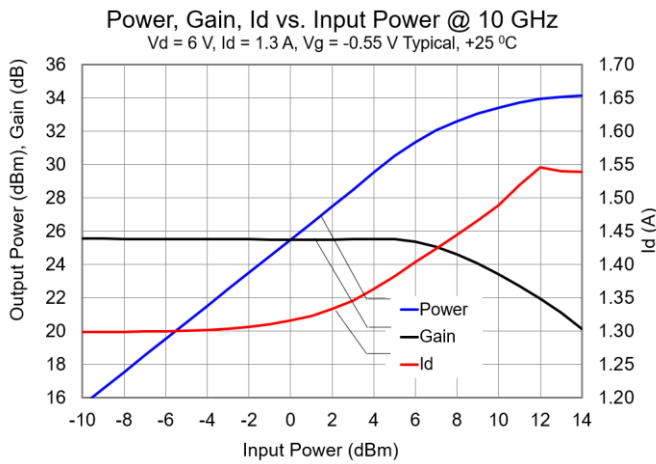
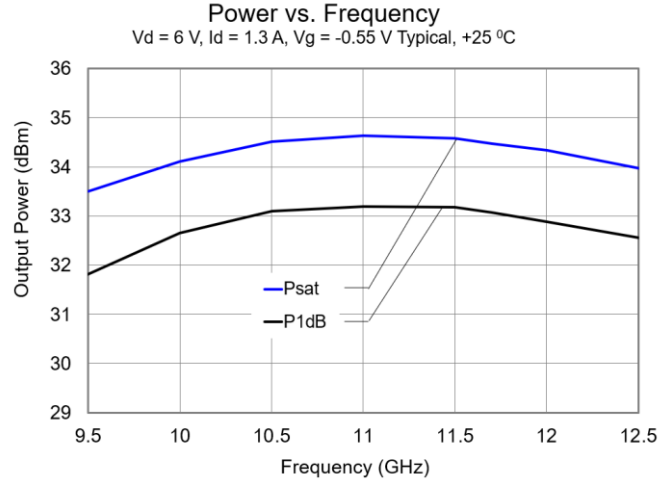
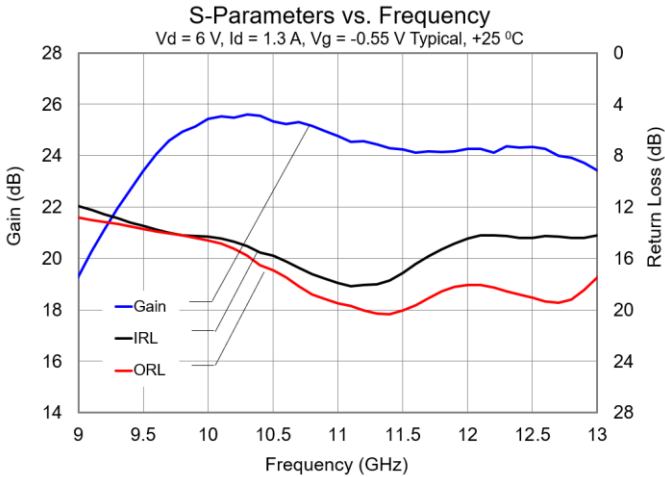

Performance Plots (cont.)

Test conditions unless otherwise noted: 25 °C, $V_d = +6.0$ V, $I_d = 1.3$ A, $V_g = -0.55$ V Typical, +25 °C.

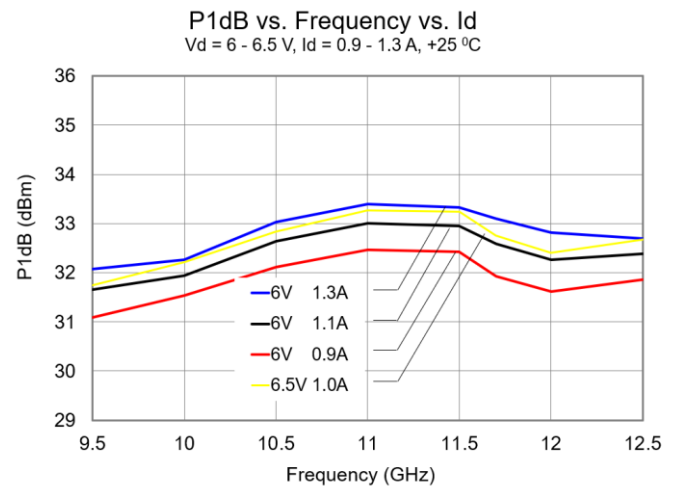
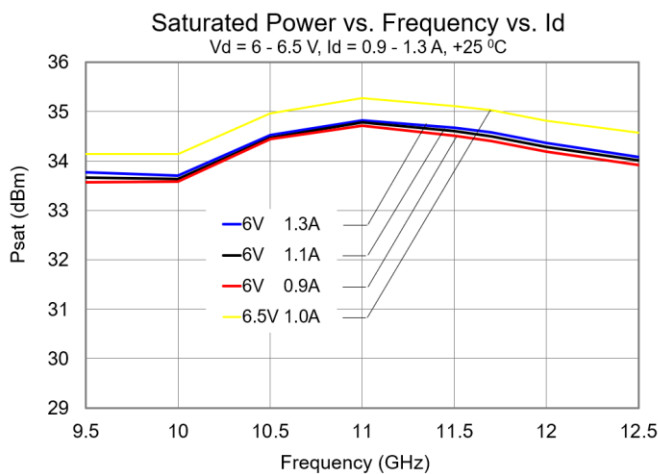
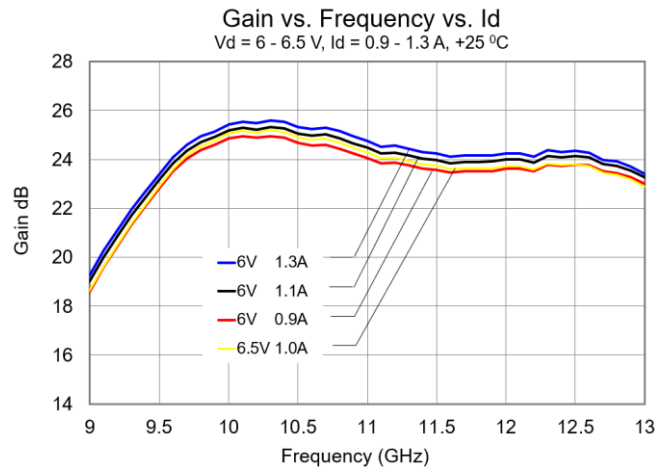
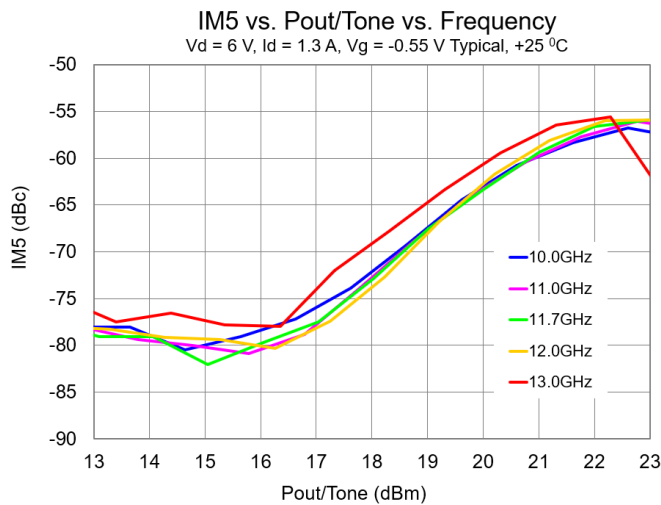
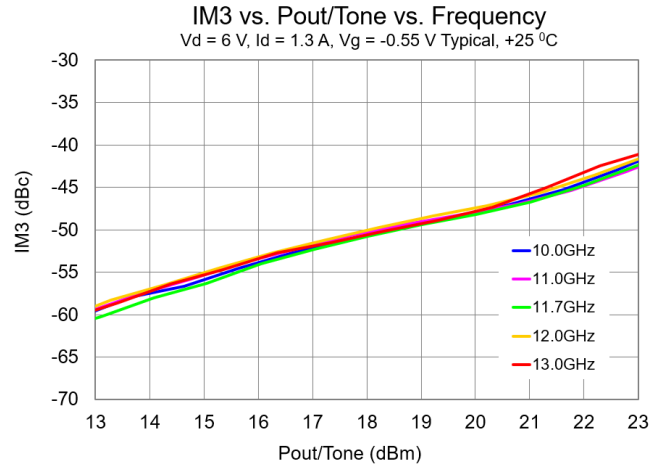
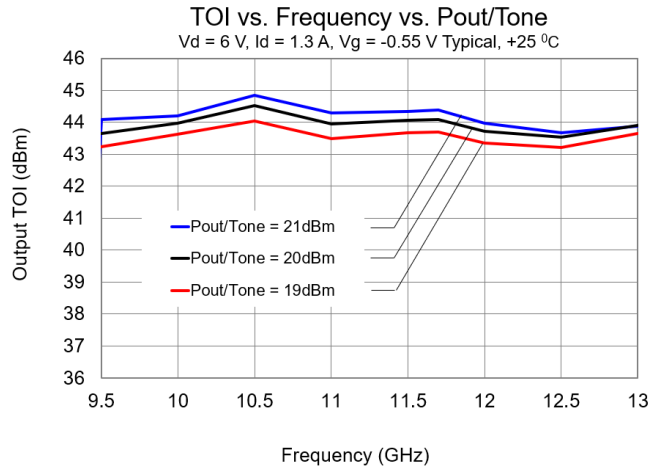

Performance Plots (cont.)

Test conditions unless otherwise noted: 25 °C, $V_d = +6.0$ V, $I_d = 1.3$ A, $V_g = -0.55$ V Typical.

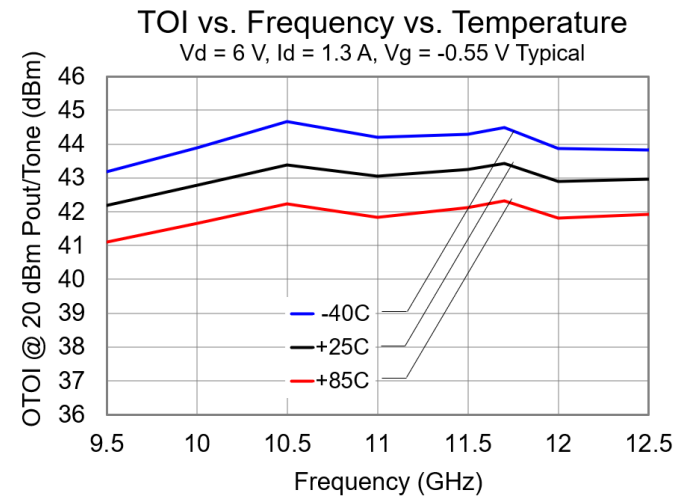
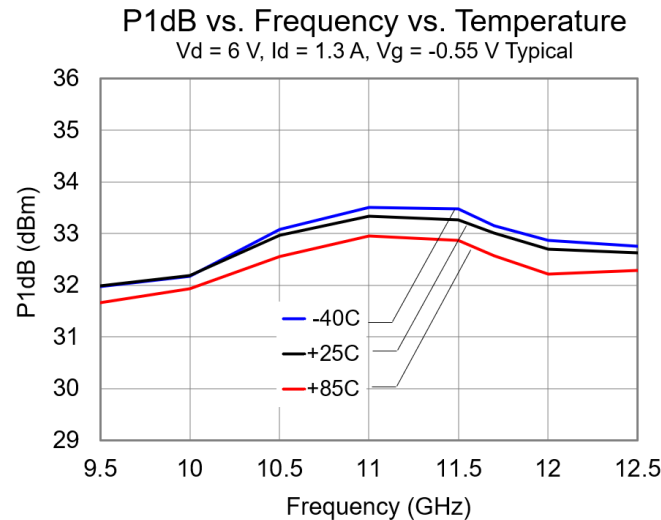
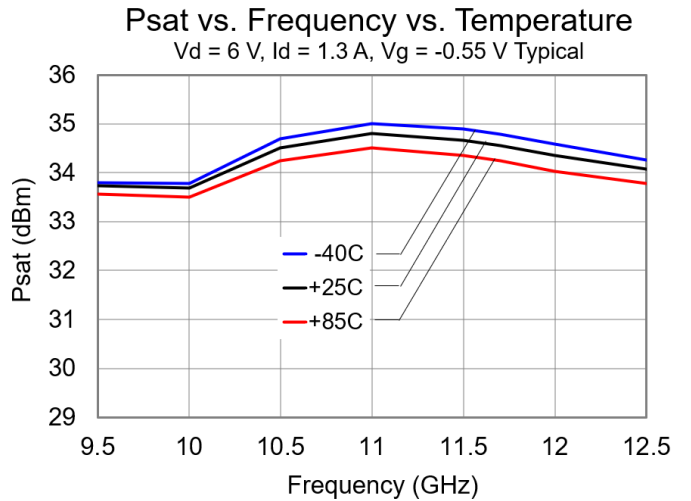
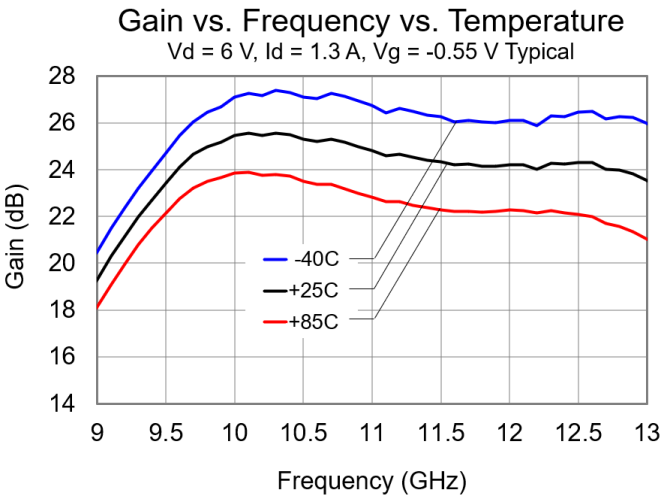
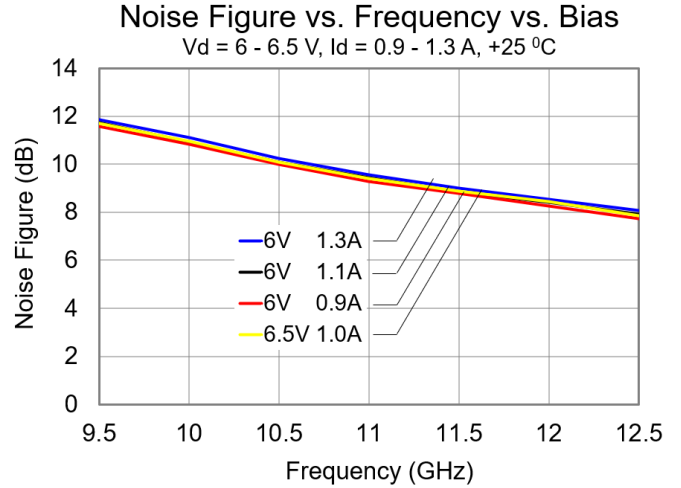
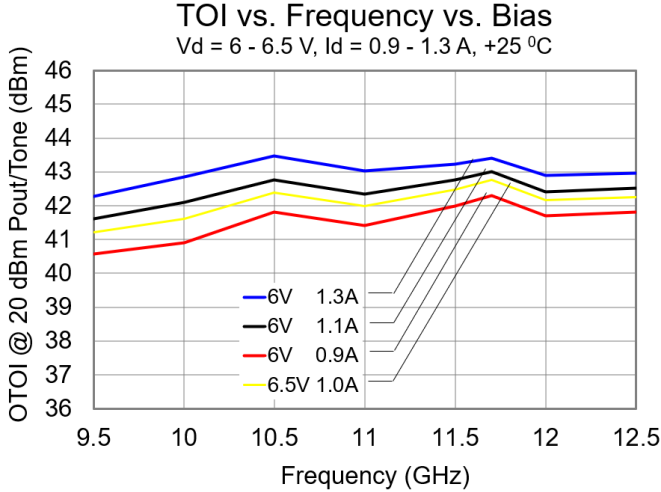

Application Circuit

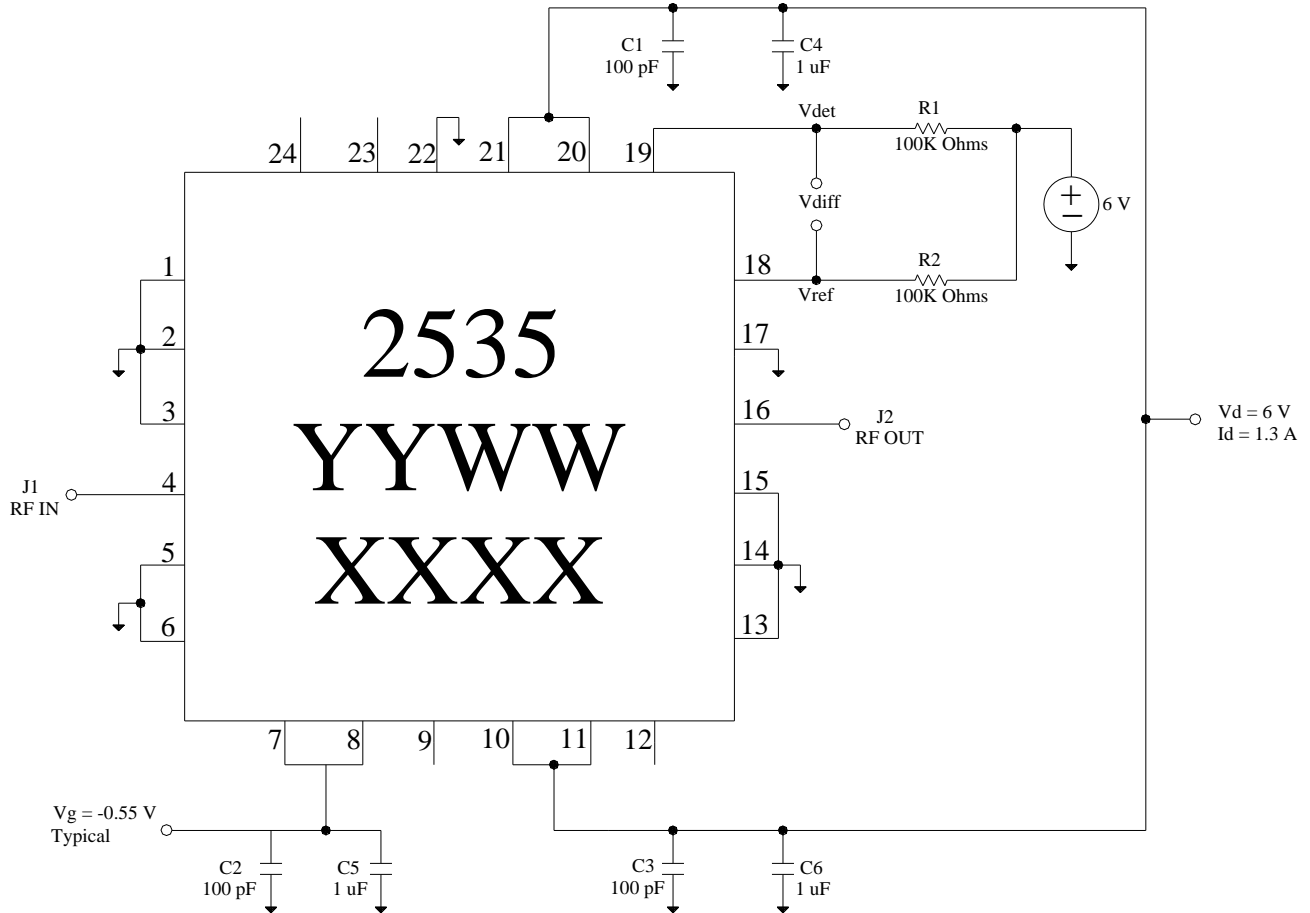

Vg can be biased from either side (pins 7 and 8 or pins 23 and 24), and the non-biased side can be left open.
Vd must be biased from both sides (pins 10, 11, 20, and 21).

Bias-up Procedure	Bias-down Procedure
Vg set to -1.5 V	Turn off RF supply
Vd set to +6 V	Reduce Vg to -1.5V. Ensure Id ~ 0 mA
Adjust Vg more positive until quiescent Id is 1.3A. This will be ~ Vg = -0.55 V	Turn Vd to 0 V
Apply RF signal to RF Input	Turn Vg to 0 V

The TGA2535-SM will be marked with the “2535” designator and a lot code marked below the part designator. The “YY” represents the last two digits of the year the part was manufactured, the “WW” is the work week, and the “XXXX” is an auto-generated number.

Pin Configuration and Description

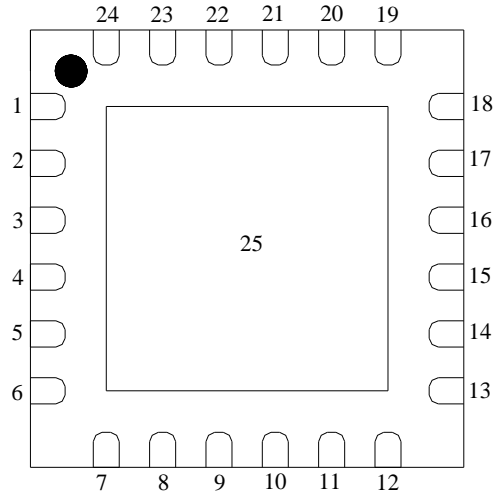

Pin	Symbol	Description
1, 2, 3, 5, 6, 13, 14, 15, 17	N/C	No internal connection; must be grounded on PCB
4	RF IN	Input, matched to 50 ohms
7, 8, 23, 24	Vg	Gate voltage. ESD protection included; Bias network is required; can be biased from either side (pins 7 and 8 or pins 23 and 24), and non-biased side can be left opened; see Application Circuit on page 7 as an example.
9, 12	N/C	No internal connection; can be grounded on PCB or left open
10, 11, 20, 21	Vd	Drain voltage. Bias network is required; must be biased from both sides; see Application Circuit on page 7 as an example.
16	RF OUT	Output, matched to 50 ohms
18	Vref	Reference diode output voltage
19	Vdet	Detector diode output voltage; varies with RF output power
22	GND	Internal grounding; can be grounded on PCB or left open
25	GND	Backside Paddle. Multiple vias should be employed to minimize inductance and thermal resistance; see PCB Mounting Pattern on page 11 for suggested footprint.

Evaluation Board PCB Information

Top RF layer is 0.008" thick Rogers RO4003, $\epsilon_r = 3.38$. Metal layers are 1-oz copper. Microstrip 50 Ω line detail: width = 0.0175".

The pad pattern shown has been developed and tested for optimized assembly at Qorvo (formerly TriQuint) Semiconductor. The PCB land pattern has been developed to accommodate lead and package tolerances. Since surface mount processes vary from company to company, careful process development is recommended.

For further technical information, refer to the [TGA2533-SM](#) Product Information page.

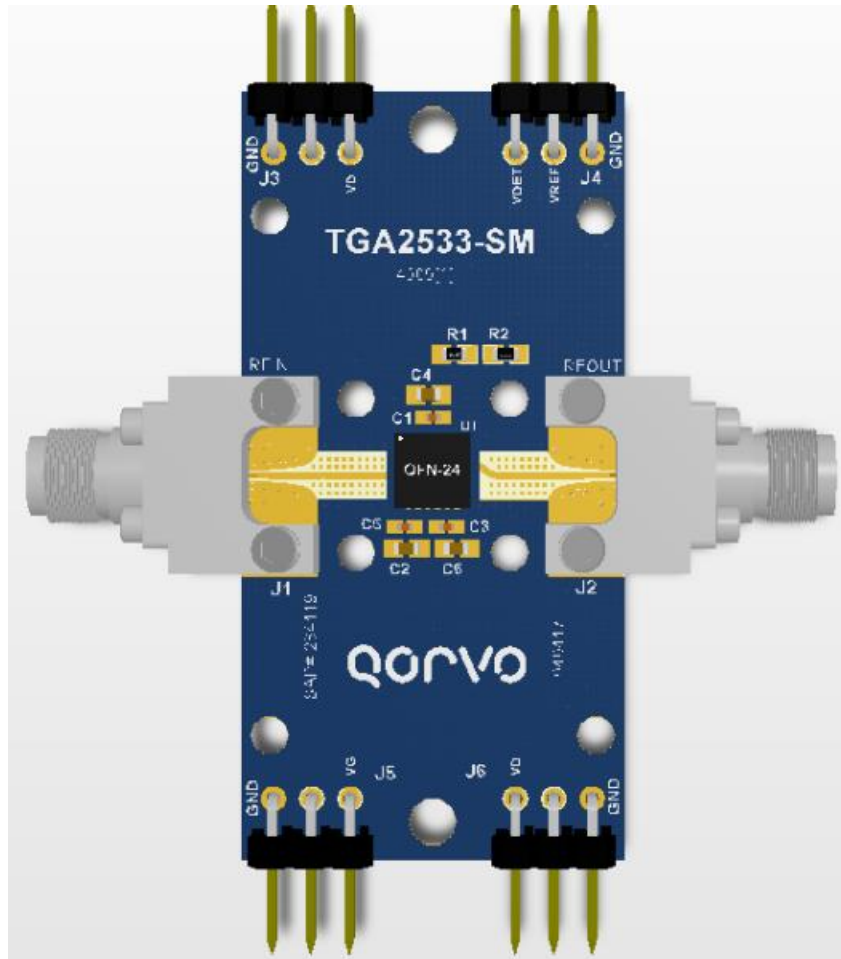

Bill of Materials

Ref Des	Value	Description	Manufacturer	Part Number
C1, C2, C3	100 pF	Cap, 0402, 50 V, 5%, COG	various	
C4, C5, C6	1 uF	Cap, 0603, 25 V, 10%, X5R	various	
R1, R2	100K Ohms	Res, 0603, 0.1 W, 5%, SMD	various	

Mechanical Drawings & Dimensions

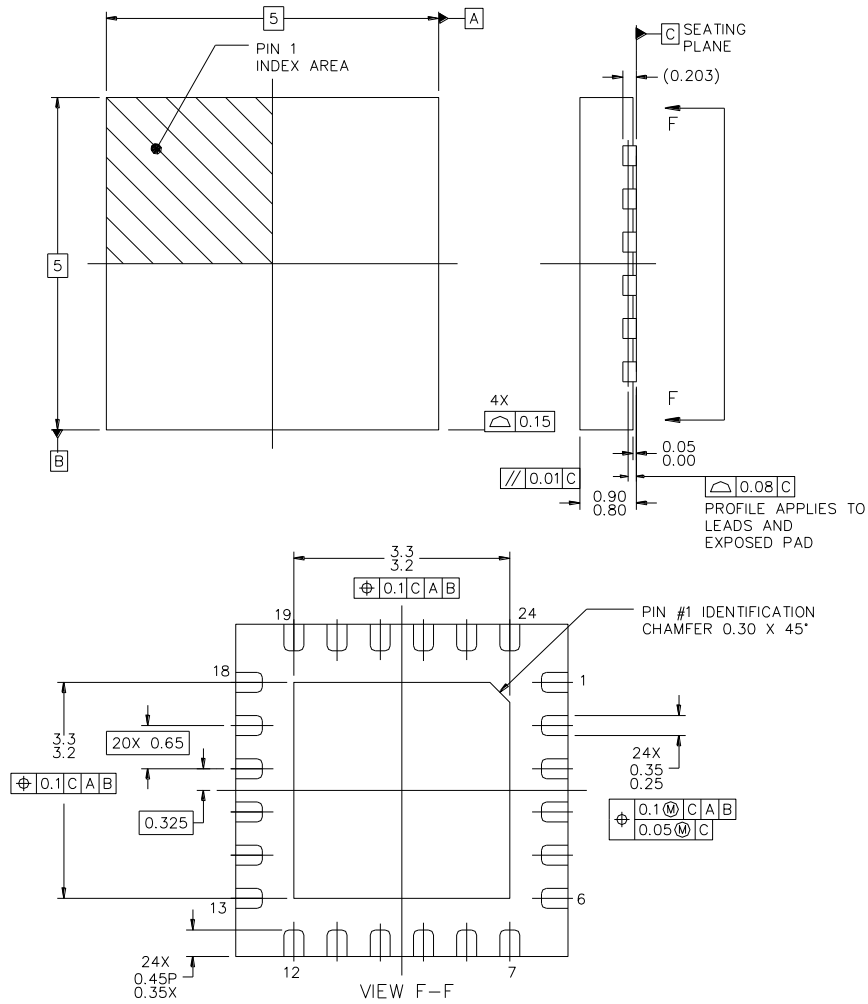

This package is lead-free/RoHS-compliant with a copper alloy base (CDA194), and the plating material on the leads is 100% matte Sn. It is compatible with both lead-free (maximum 260 °C reflow temperature) and tin-lead (maximum 245 °C reflow temperature) soldering processes.

PCB Mounting Pattern

Notes:

1. All dimensions are in millimeters (inches).
2. A heatsink underneath the area of the PCB for the mounted device is recommended for proper thermal operation.
3. Ground / thermal vias are critical for the proper performance of this device.
Vias have a final plated thru diameter of .40 mm (.016").

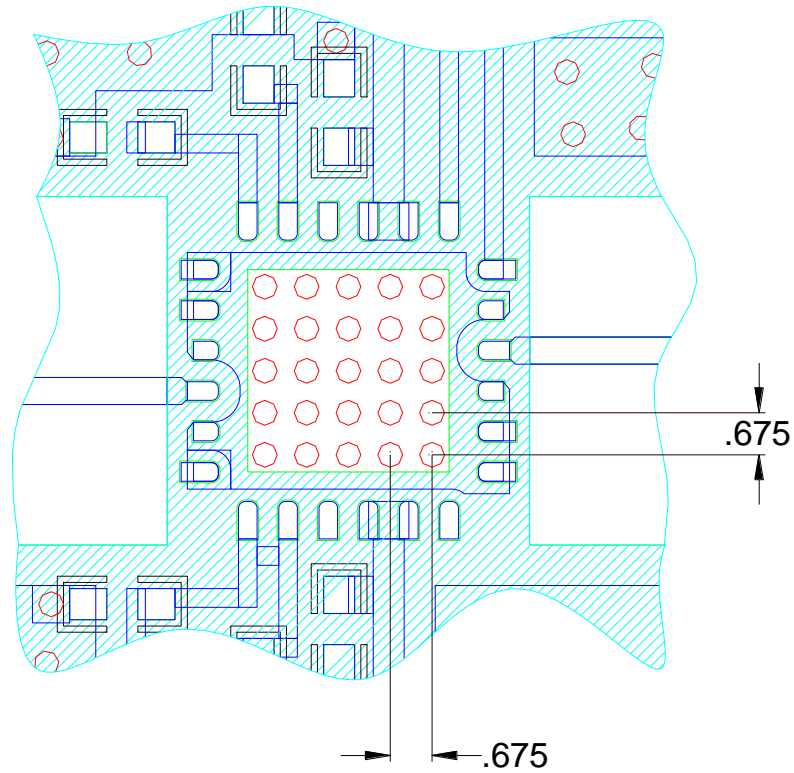

Tape and Reel Information

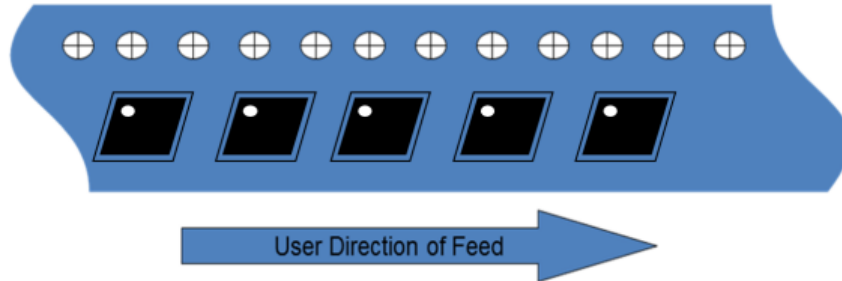

Carrier and Cover Tape Physical Dimensions

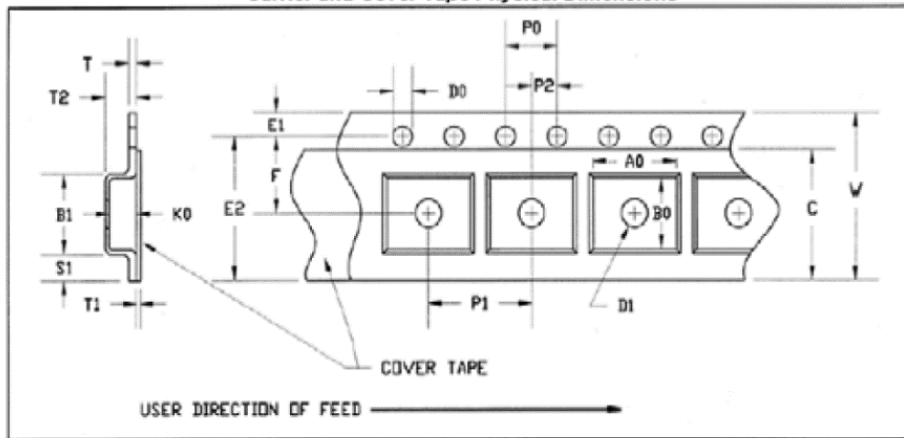

CARRIER AND COVER TAPE DIMENSIONS

Part	Feature	Symbol	Size (in)	Size (mm)
Cavity	Length	A0	0.207	5.25
	Width	B0	0.207	5.25
	Depth	K0	0.043	1.10
	Pitch	P1	0.315	8.00
Distance Between Centerline	Cavity to Perforation Length Direction	P2	0.079	2.00
	Cavity to Perforation Width Direction	F	0.217	5.50
Cover Tape	Width	C	0.374	9.5
Carrier Tape	Width	W	0.472	12.0

Solderability

Compatible with the latest version of J-STD-020, Lead free solder, 260°C and tin-lead (maximum 245 °C reflow temperature) soldering processes.

Contact plating: NiAu

Recommended Soldering Temperature Profile

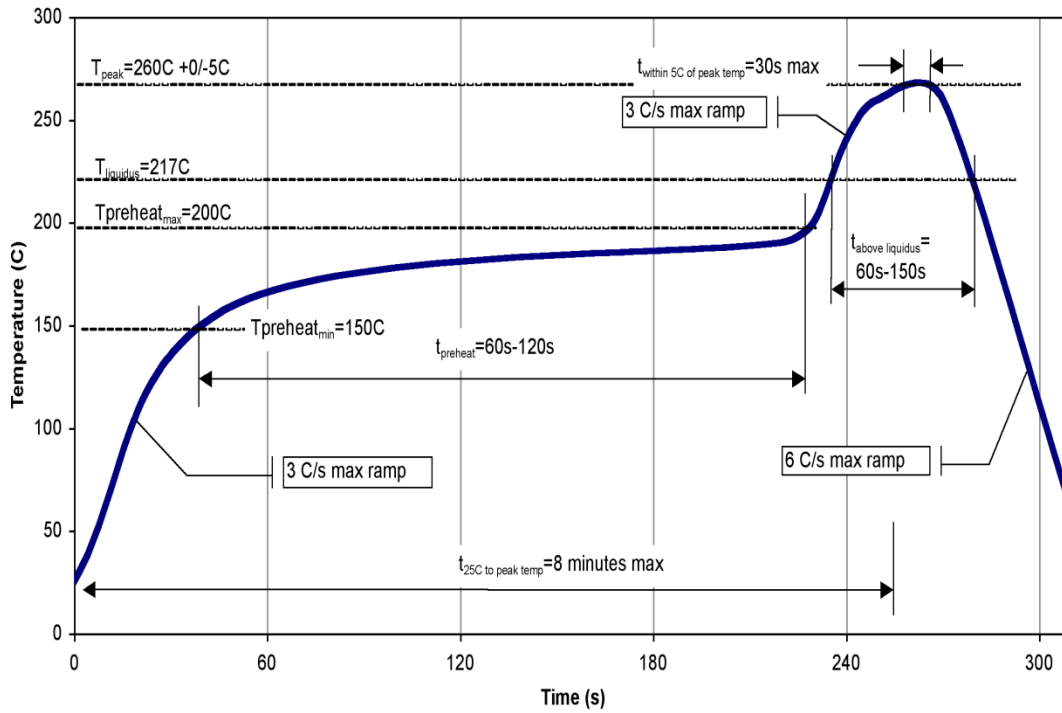

Handling Precautions

Parameter	Rating	Standard
ESD – Human Body Model (HBM)	Class 0	ESDA / JEDEC JESDC22-A114
MSL – Moisture Sensitivity Level	MSL3	IPC/JEDEC J-STD-020



Caution!
ESD-Sensitive Device

RoHS Compliance

This part is compliant with 2011/65/EU RoHS directive (Restrictions on the Use of Certain Hazardous Substances in Electrical and Electronic Equipment) as amended by Directive 2015/863/EU.

This product also has the following attributes:

- Lead Free
- Halogen Free (Chlorine, Bromine)
- Antimony Free
- TBBP-A (C₁₅H₁₂Br₄O₂) Free
- PFOS Free
- SVHC Free

Contact Information

For the latest specifications, additional product information, worldwide sales and distribution locations:

Web: www.qorvo.com

Tel: 1-844-890-8163

Email: customer.support@qorvo.com

Important Notice



The information contained herein is believed to be reliable; however, Qorvo makes no warranties regarding the information contained herein and assumes no responsibility or liability whatsoever for the use of the information contained herein. All information contained herein is subject to change without notice. Customers should obtain and verify the latest relevant information before placing orders for Qorvo products. The information contained herein or any use of such information does not grant, explicitly or implicitly, to any party any patent rights, licenses, or any other intellectual property rights, whether with regard to such information itself or anything described by such information. **THIS INFORMATION DOES NOT CONSTITUTE A WARRANTY WITH RESPECT TO THE PRODUCTS DESCRIBED HEREIN, AND QORVO HEREBY DISCLAIMS ANY AND ALL WARRANTIES WITH RESPECT TO SUCH PRODUCTS WHETHER EXPRESS OR IMPLIED BY LAW, COURSE OF DEALING, COURSE OF PERFORMANCE, USAGE OF TRADE OR OTHERWISE, INCLUDING THE IMPLIED WARRANTIES OF MERCHANTABILITY AND FITNESS FOR A PARTICULAR PURPOSE.**

Without limiting the generality of the foregoing, Qorvo products are not warranted or authorized for use as critical components in medical, life-saving, or life-sustaining applications, or other applications where a failure would reasonably be expected to cause severe personal injury or death.

Copyright 2025 © Qorvo, Inc. | Qorvo is a registered trademark of Qorvo, Inc.

Looking for pricing, stock, or lifecycle information?

Click below to explore more details on WIN SOURCE:

-  [View TGA2535-SM on WIN SOURCE](#)
-  [Qorvo US Inc. Information](#)

Optimize Your Supply Chain with WIN SOURCE Solutions

-  Global Sourcing Solution
-  Obsolete Management
-  Cost Control Management
-  Shortage Management
-  Alternative Solution
-  Excess Inventory Management