

Features

- ▶ Low noise figure, high gain
- ▶ High IP3
- ▶ Broadband performance
- ▶ Single positive supply voltage
- ▶ Small die size

Description

The CMD271 is a broadband MMIC low noise amplifier ideally suited for EW and communications systems where small size and low power consumption are needed. The broadband device delivers 20 dB of gain with a corresponding output IP3 of +27 dBm and a noise figure of 1.8 dB at 8 GHz. The CMD271 is a 50 ohm matched design eliminating the need for external DC blocks and RF port matching. The CMD271 offers full passivation for increased reliability and moisture protection.

Functional Block Diagram

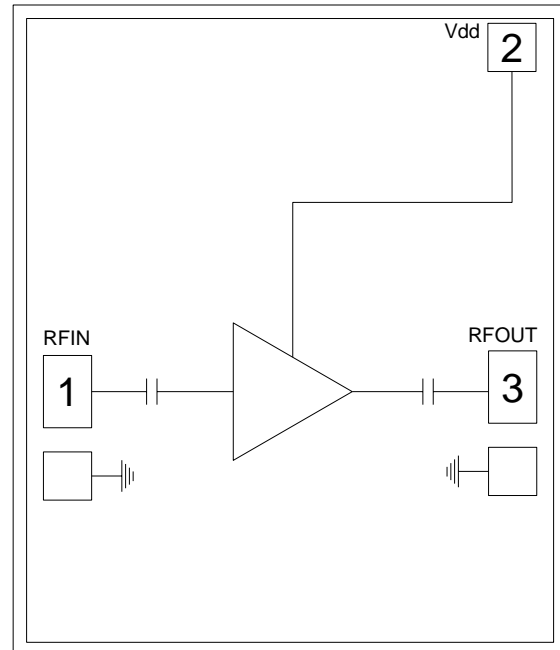

Electrical Performance - $V_{dd} = 5.0\text{ V}$, $T_A = 25\text{ }^\circ\text{C}$, $F = 8\text{ GHz}$

Parameter	Min	Typ	Max	Units
Frequency Range	6 - 11			GHz
Gain		20		dB
Noise Figure		1.9		dB
Input Return Loss		15		dB
Output Return Loss		15		dB
Output P1dB		16.5		dBm
Output IP3		27		dBm
Supply Current		66		mA

ver A 0420

Specifications

Absolute Maximum Ratings

Parameter	Rating
Drain Voltage, V _{dd}	5.5 V
RF Input Power	+20 dBm
Channel Temperature, T _{ch}	150 °C
Power Dissipation, P _{diss}	537 mW
Thermal Resistance, Q _{JC}	121 °C/W
Operating Temperature	-40 to 85 °C
Storage Temperature	-55 to 150 °C

Exceeding any one or combination of the maximum ratings may cause permanent damage to the device.

Recommended Operating Conditions

Parameter	Min	Typ	Max	Units
V _{dd}	3.0	5.0	5.25	V
I _{dd}		66		mA

Electrical performance is measured at specific test conditions. Electrical specifications are not guaranteed over all recommended operating conditions.

Drain Current vs. Drain Voltage

V _{dd} (V)	I _{dd} (mA)
3.0	30
4.0	46
5.0	66

Electrical Specifications - V_{dd} = 5.0 V, T_A = 25 °C

Parameter	Min	Typ	Max	Min	Typ	Max	Units
Frequency Range	6 - 8		8 - 11				GHz
Gain	17	21		15.5	18.5		dB
Noise Figure		2.3	2.9		2	2.3	dB
Input Return Loss		18			15		dB
Output Return Loss		18			15		dB
Output P1dB		16.5			16.5		dBm
Output IP3		26.5			26.5		dBm
Supply Current	46	66	86	46	66	86	mA
Gain Temperature Coefficient		0.015			0.015		dB/°C
Noise Figure Temperature Coefficient		0.008			0.008		dB/°C

ver A 0420

Typical Performance

Broadband Performance, $V_{dd} = 5.0$ V, $T_A = 25$ °C

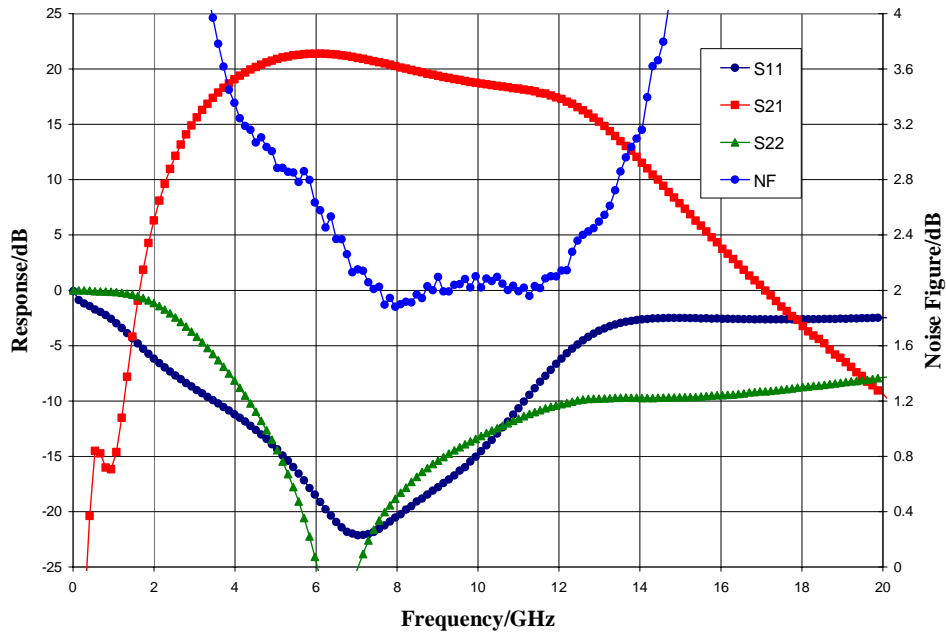

Narrow-band Performance, $V_{dd} = 5.0$ V, $T_A = 25$ °C

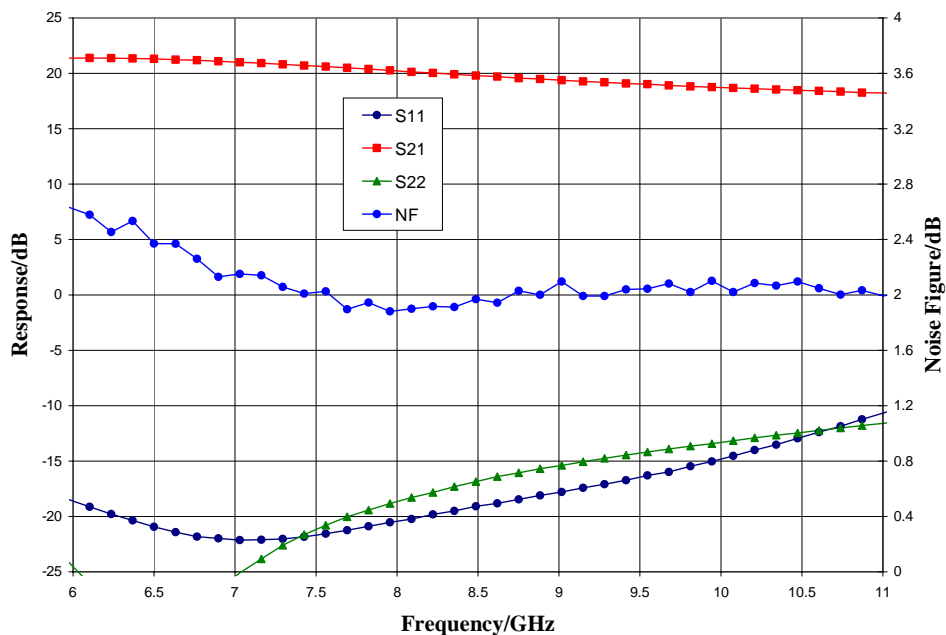

ver A 0420

Typical Performance

Gain vs. Temperature, $V_{dd} = 5.0\text{ V}$

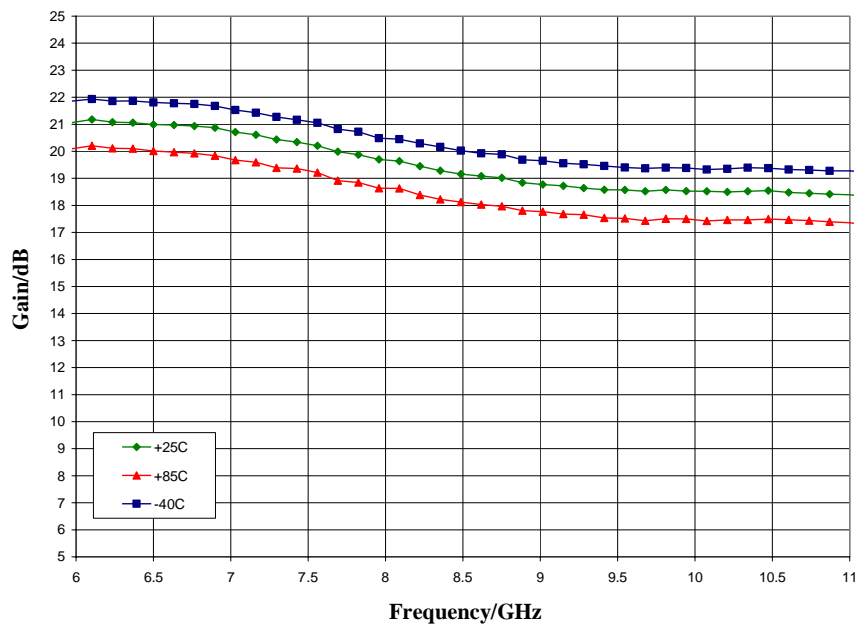

Gain vs. V_{dd} , $T_A = 25\text{ }^\circ\text{C}$

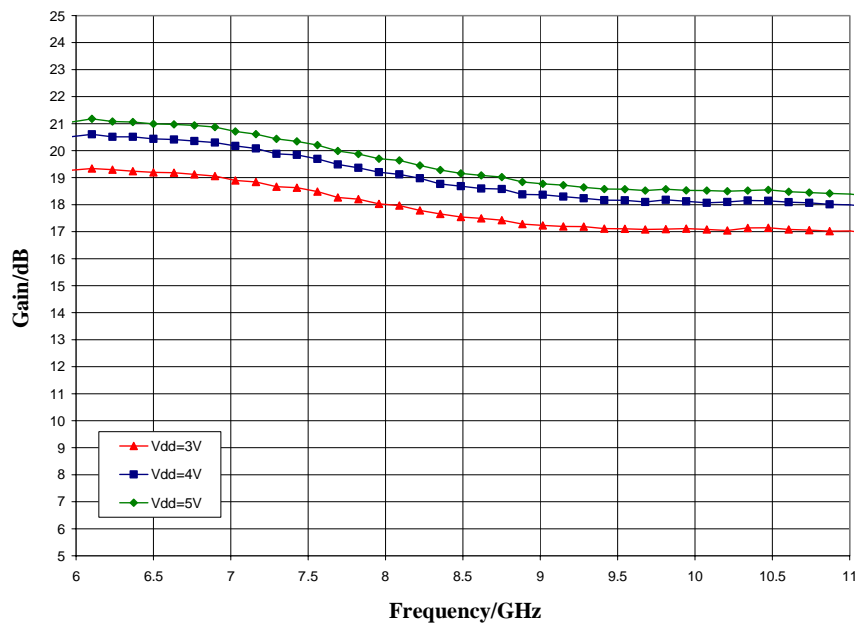

ver A 0420

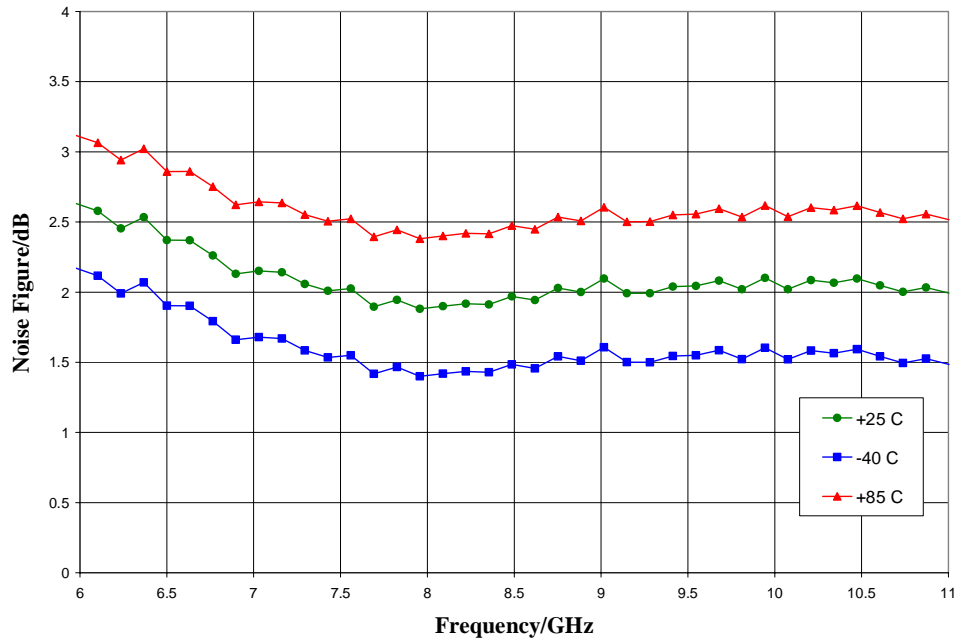
*Typical Performance*Noise Figure vs. Temperature, $V_{dd} = 5.0\text{ V}$ 

Typical Performance

P1dB vs. Temperature, $V_{dd} = 5.0\text{ V}$

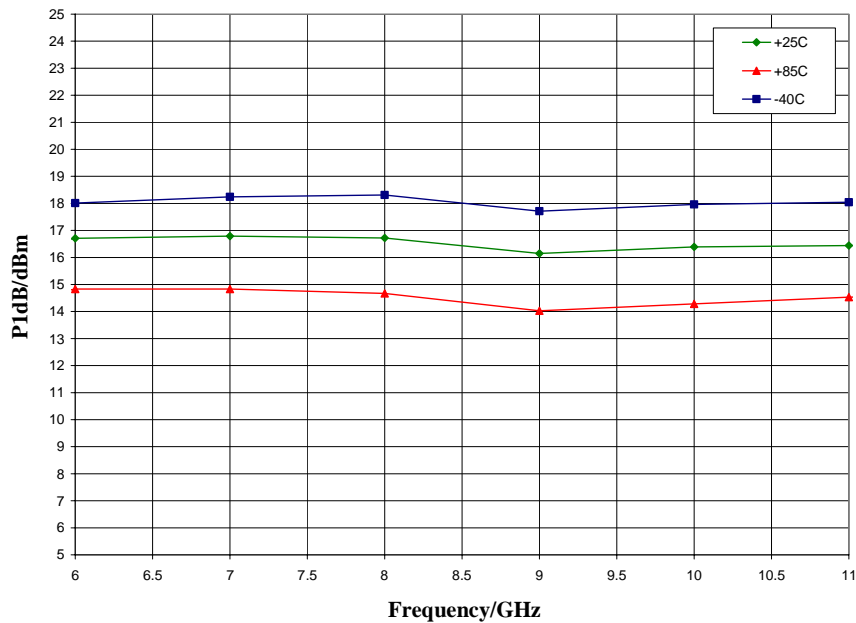

P1dB vs. Vdd, $T_A = 25\text{ }^\circ\text{C}$

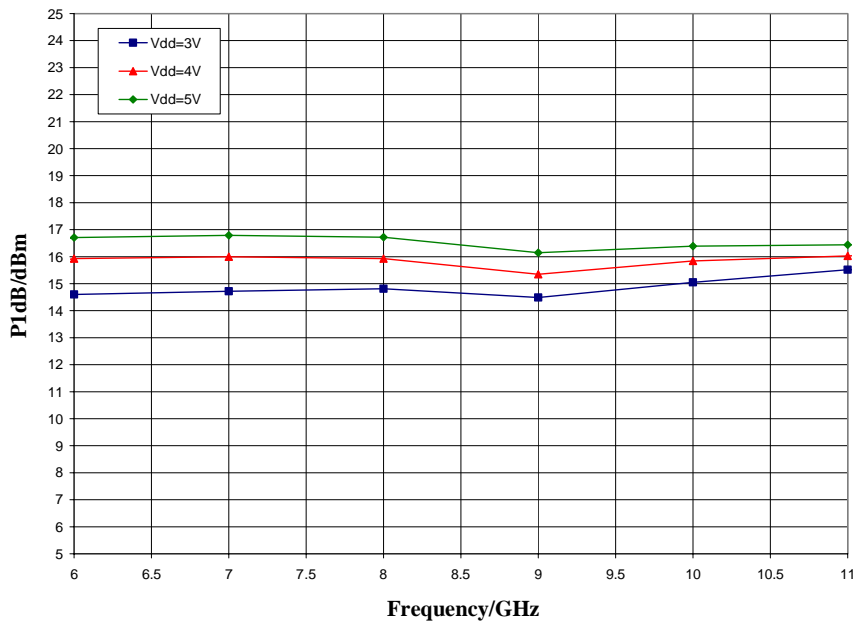

ver A 0420

Typical Performance

Psat vs. Temperature, $V_{dd} = 5.0\text{ V}$

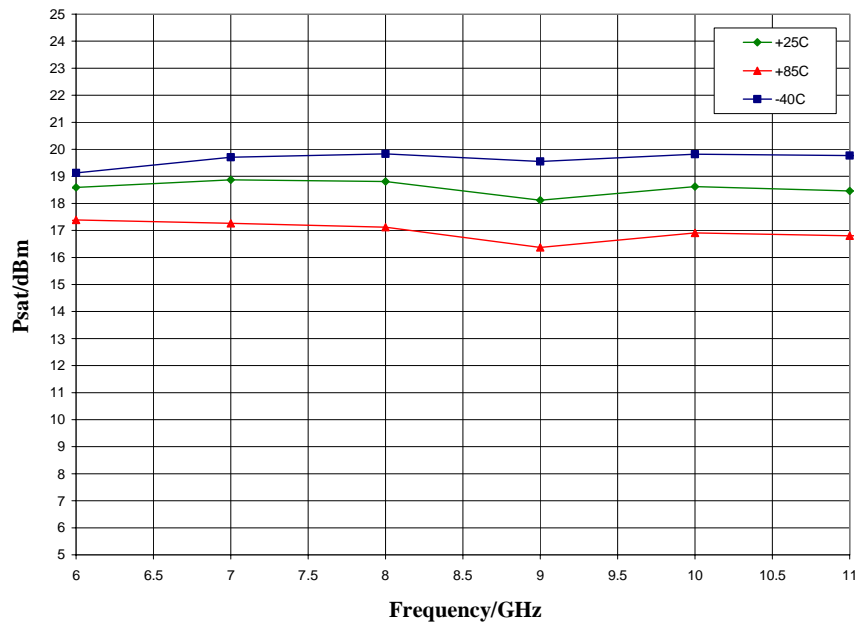

Psat vs. Vdd, $T_A = 25\text{ }^\circ\text{C}$

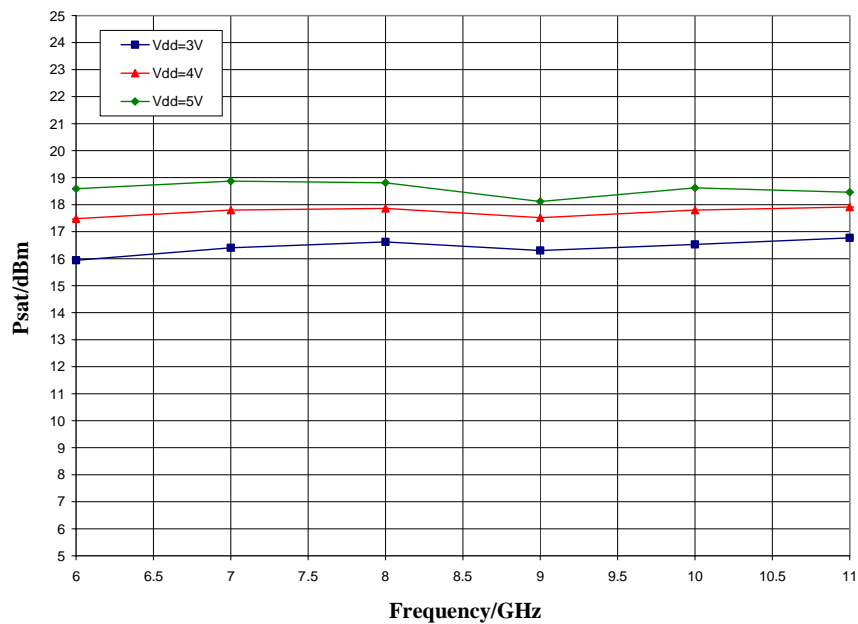

ver A 0420

Typical Performance

Output IP3 vs. Temperature, $V_{dd} = 5.0$ V

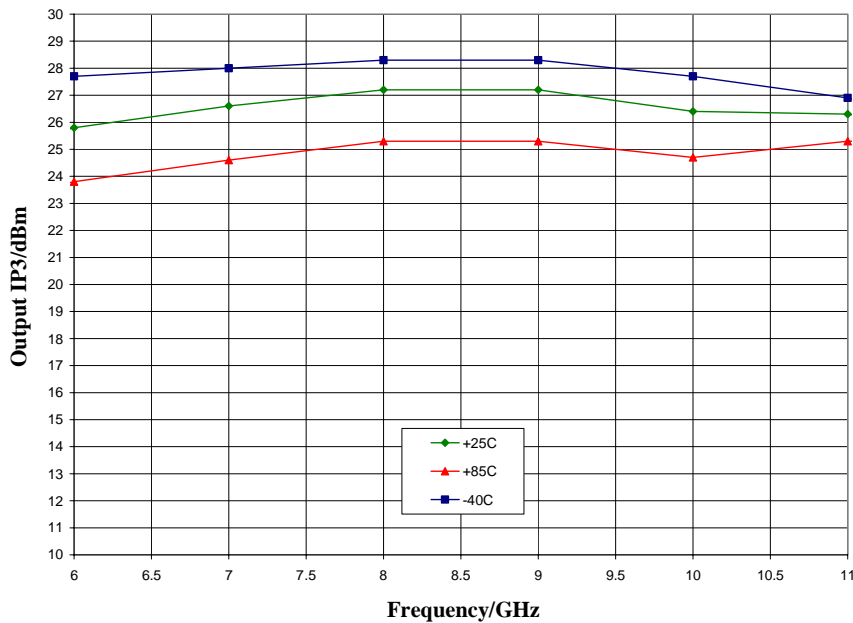

Output IP3 vs. Vdd, $T_A = 25$ °C

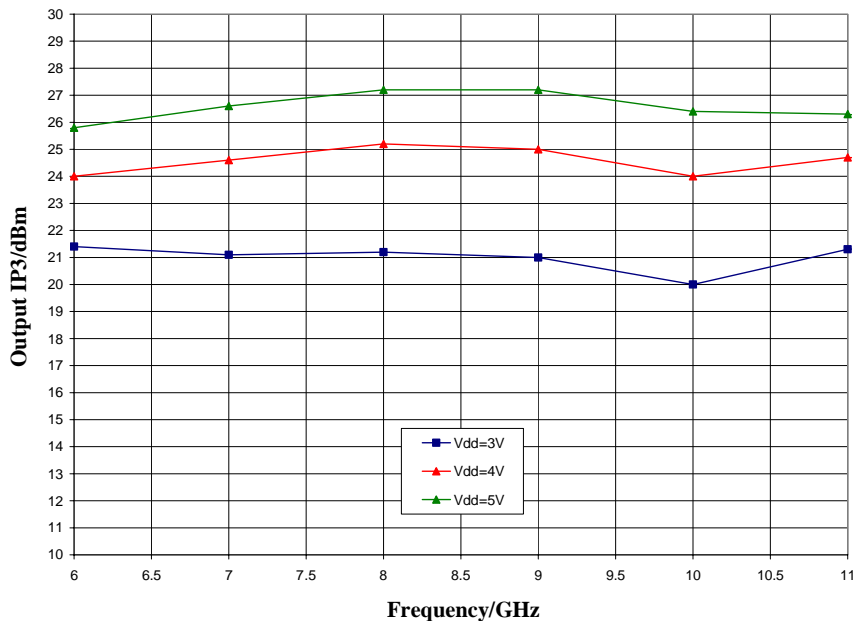

ver A 0420

Mechanical Information

Die Outline (all dimensions in microns)

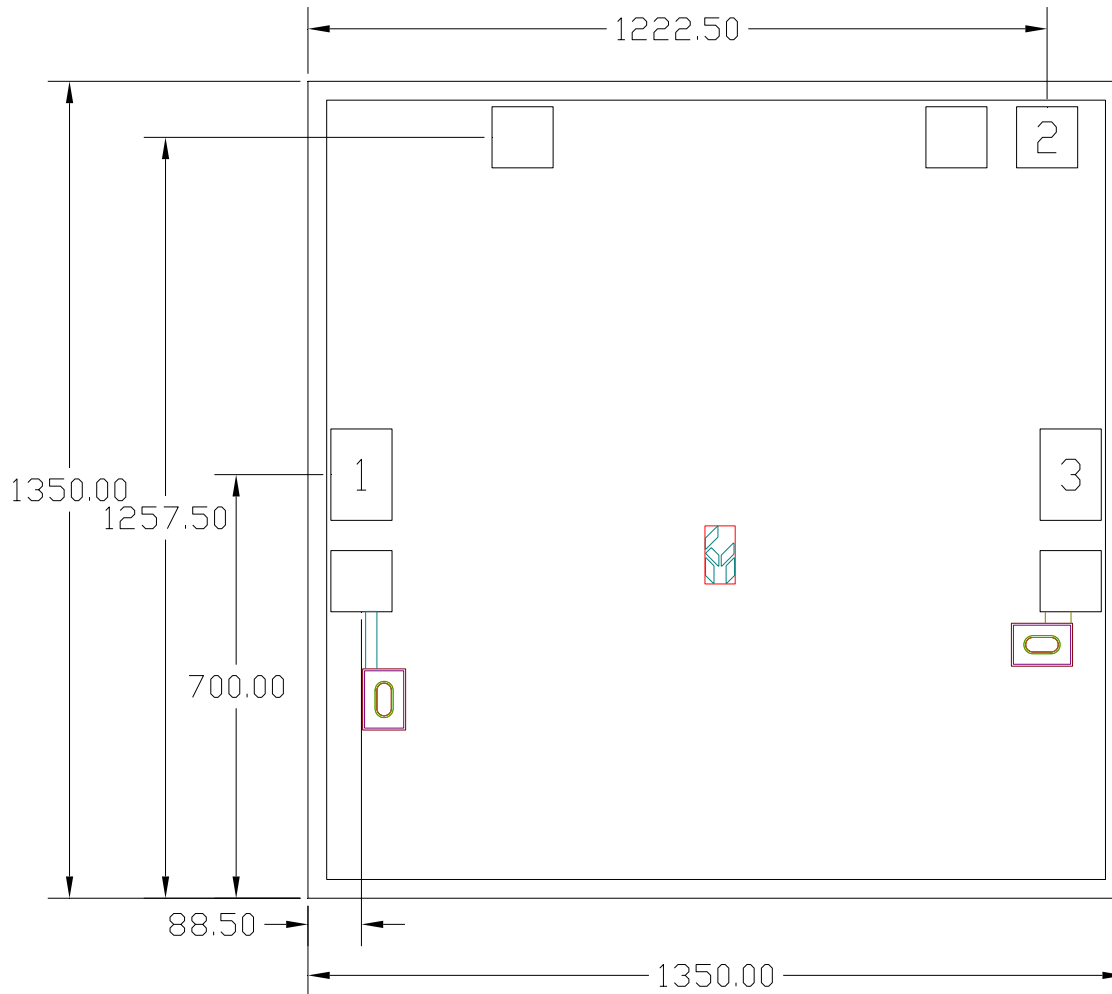

Notes:

1. No connection required for unlabeled pads
2. Backside is RF and DC ground
3. Backside and bond pad metal: Gold
4. Die is 100 microns thick
5. DC bond pad (2) is 100 microns square
6. RF bond pads (1, 3) are 100 x 150 microns



ver A 0420

Pad Description

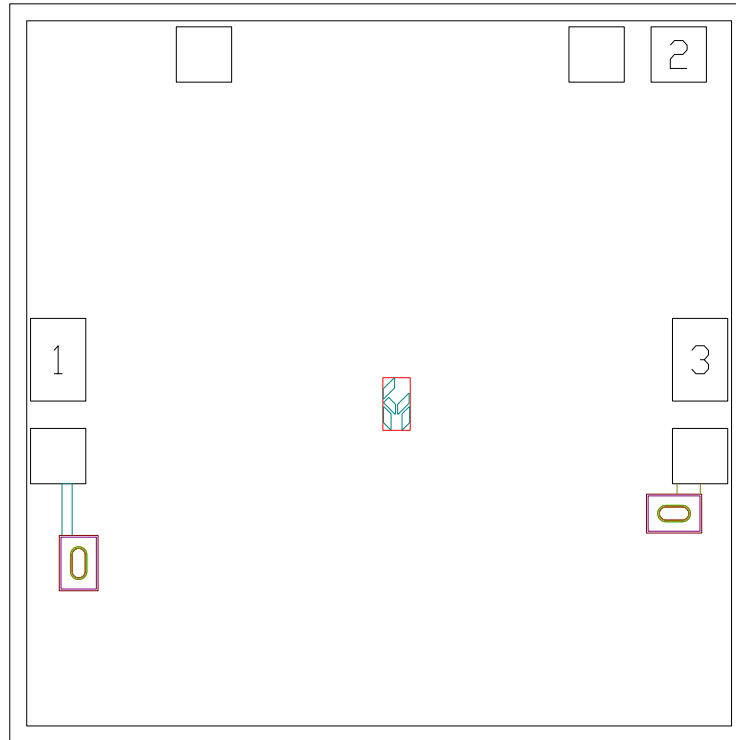
Pad Diagram

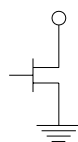

Functional Description

Pad	Function	Description	Schematic
1	RF in	DC blocked and 50 ohm matched	
2	Vdd	Power supply voltage Decoupling and bypass caps required	
3	RF out	DC blocked and 50 ohm matched	
Backside	Ground	Connect to RF / DC ground	

ver A 0420

Applications Information

Assembly Guidelines

The backside of the CMD271 is RF ground. Die attach should be accomplished with electrically and thermally conductive epoxy or eutectic attach. Standard assembly procedures should be followed for high frequency devices. The top surface of the semiconductor should be made planar to the adjacent RF transmission lines, and the RF decoupling capacitors placed in close proximity to the DC connections on chip.

RF connections should be made as short as possible to reduce the inductive effect of the bond wire. Use of a 0.8 mil thermosonic wedge bonding is highly recommended as the loop height will be minimized. The RF input and output require a double bond wire as shown.

The semiconductor is 100 um thick and should be handled by the sides of the die or with a custom collet. Do not make contact directly with the die surface as this will damage the monolithic circuitry. Handle with care.

Assembly Diagram

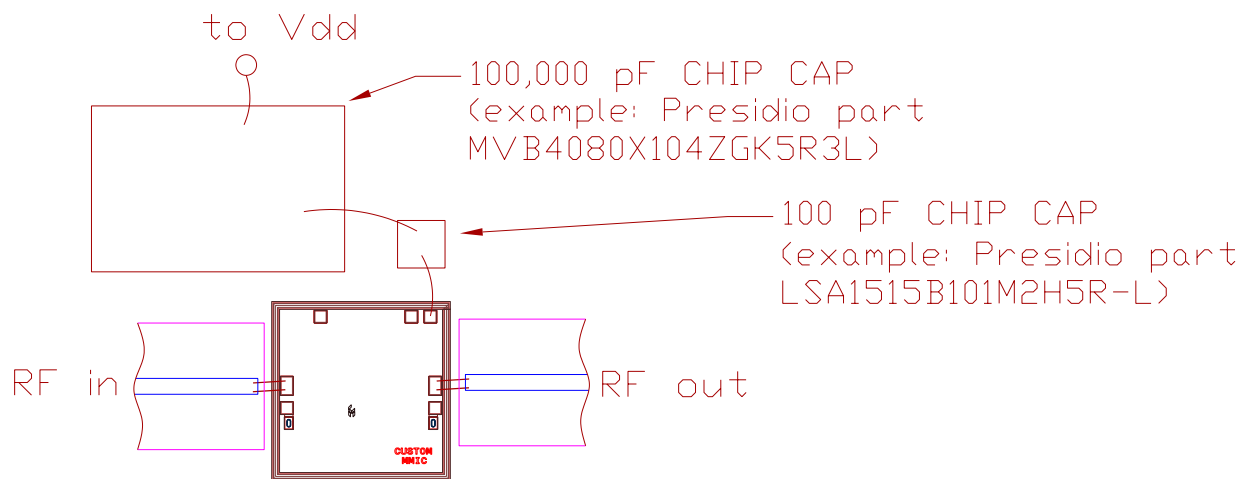

GaAs MMIC devices are susceptible to damage from Electrostatic Discharge. Proper precautions should be observed during handling, assembly and test.

ver A 0420

Applications Information

Application Circuit

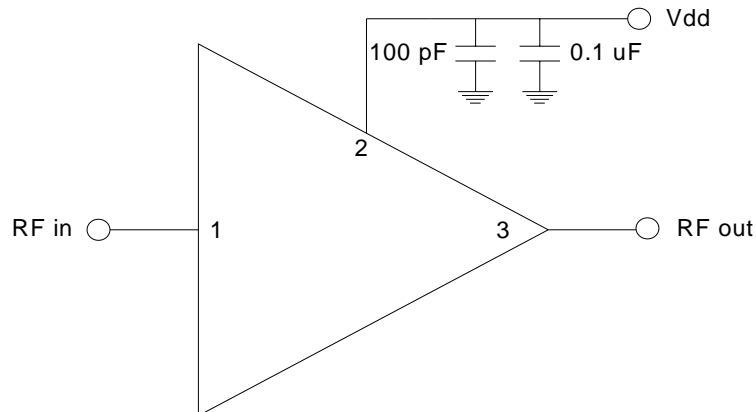

Biasing and Operation

The CMD271 is biased with a single positive drain supply. Performance is optimized when the drain voltage is set to +5.0 V, though it may be set to a minimum of +2.0 V and a maximum of +5.5 V

Turn ON procedure:

1. Apply drain voltage V_{dd} and set to +5 V

Turn OFF procedure:

1. Turn off drain voltage V_{dd}

RF power can be applied at any time.

Looking for pricing, stock, or lifecycle information?

Click below to explore more details on WIN SOURCE:

 [View CMD271 on WIN SOURCE](#)

 [Qorvo US Inc. Information](#)

Optimize Your Supply Chain with WIN SOURCE Solutions

-  Global Sourcing Solution
-  Obsolete Management
-  Cost Control Management
-  Shortage Management
-  Alternative Solution
-  Excess Inventory Management