



TGA2731-SM

2.7–4.0 GHz Driver Amplifier

General Description

Qorvo's TGA2731-SM is a driver amplifier fabricated on Qorvo's QPHT25 0.25 um GaAs production process. The TGA2731-SM operates from 2.7 to 4.0 GHz and provides > 30.7 dBm of output power with > 22.7 dB of large signal gain. The TGA2731-SM also includes a 13 dB attenuator at the input, and a simple resistively coupled power detector at the output. The amplifier can be operated from a single supply in the self-biased mode.

The TGA2731-SM is offered in a 5x5 mm plastic QFN. It is well-matched to 50 ohms, and includes integrated DC blocking caps on both RF ports allowing for simple system integration.

Lead-Free & RoHS compliant.

Evaluation Boards are available on request.



Product Features

- Frequency Range: 2.7-4.0 GHz
- Small Signal Gain: > 24 dB
- Power: > 30.7 dBm
- PAE: > 22 %
- IM3: < -32 dBc (@ 3.5 GHz)
- Input Return Loss > 7 dB
- Output Return Loss > 11 dB
- Self-Bias: $V_D = 6\text{ V}$, $V_G = 0\text{ V}$, $I_{DQ} = 900\text{ mA}$
- Single Supply Operation
- Package Dimensions: 5.0 x 5.0 x 0.85 mm

Functional Block Diagram

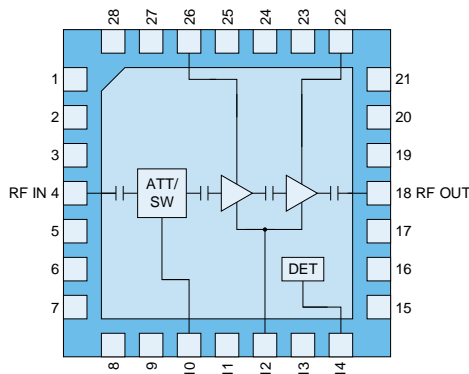

Applications

- Commercial and Military Radar
- Communications
- Test Instrumentation

Ordering Information

Part	Description
TGA2731-SM	2.7–4.0 GHz Driver Amplifier
TGA2731-SM EVB	Evaluation Board

Absolute Maximum Ratings

Parameter	Value/Range
Drain Voltage (V_D)	9
Gate Voltage Limits (V_G)	-1 V/0V
Drain Current (I_D)	1000 mA
Gate Current ($+I_G$ @ $T_{CH} = 150\text{ }^\circ\text{C}$)	-5.28/24.8 mA
Power Dissipation, $T_{BASE} = 85\text{ }^\circ\text{C}$, $T_{CH} = 200\text{ }^\circ\text{C}$, CW operation (P_{DISS})	4.50 W
Input Power, CW, $50\ \Omega^1$	13 dBm
Input Power, CW, VSWR 10:1 ¹	13 dBm
Channel Temperature (T_{CH})	200 °C

Notes:

- $V_D = 6\text{ V}$, $V_G = 0\text{ V}$, $T_{BASE} = 85\text{ }^\circ\text{C}$

Operation of this device outside the parameter ranges given above may cause permanent damage. These are stress ratings only, and functional operation of the device at these conditions is not implied.

Recommended Operating Conditions

Parameter	Value/Range
Drain Voltage (V_D)	6 V
Gate Voltage (V_G) (self-biased mode)	0 V
Quiescent Drain Current (I_{DQ})	900 mA
Operating Drain Current (I_{D_DRIVE})	800-975 mA

Electrical specifications are measured at specified test conditions. Specifications are not guaranteed over all recommended operating conditions.

Electrical Specifications

Test conditions, unless otherwise noted: $T = 25\text{ }^\circ\text{C}$, $V_D = 6\text{ V}$, $V_G = 0\text{ V}$, $I_{DQ} \sim 900\text{ mA}$, $V_{SW} = 0\text{ V}$, part mounted to EVB
Output Power and PAE pulse conditions: $PW = 100\ \mu\text{s}$, $DC = 20\%$

Parameter	Min	Typical	Max	Units
Operating Frequency Range	2.7		4.0	GHz
Output Power (Pulsed, $P_{in} = 8\text{ dBm}$)		> 30.7		dBm
Power Added Efficiency (Pulsed, $P_{in} = 8\text{ dBm}$)		> 22		%
Small Signal Gain		> 24		dB
Input Return Loss		> 7		dB
Output Return Loss		> 11		dB
IM3 ($P_{OUT}/\text{tone} \leq 23\text{ dBm}$, 3.5 GHz)		< -32		dBc
2 nd Harm. Suppression ($P_{OUT} \leq 30\text{ dBm}$, 3.5 GHz)		< -39		dBc
3 rd Harm. Suppression ($P_{OUT} \leq 30\text{ dBm}$, 3.5 GHz)		< -44		dBc
Output Power Temperature Coefficient		-0.004		dB/°C

Typical Performance (Small Signal)

Test conditions, unless otherwise noted: T = 25 °C, part mounted to EVB

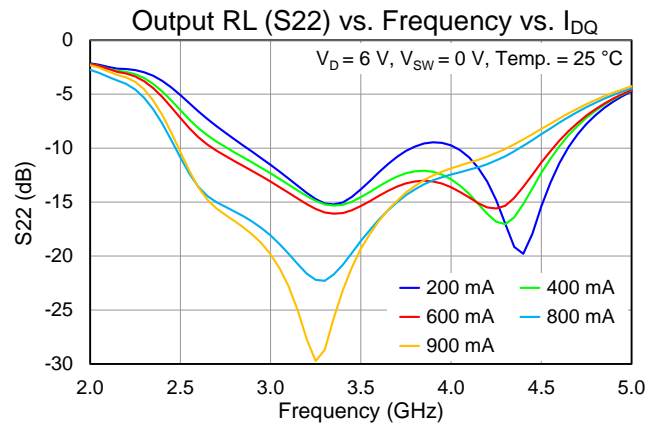
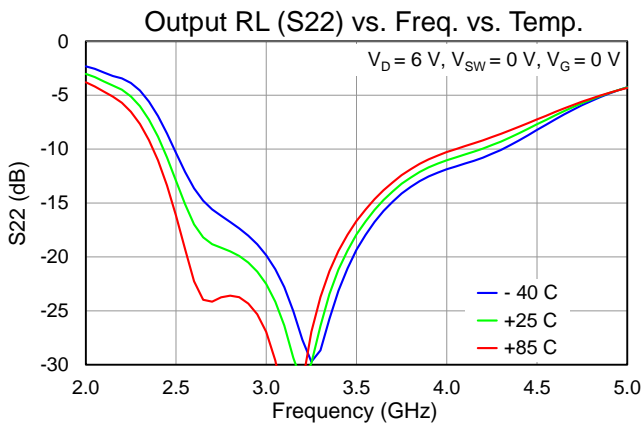
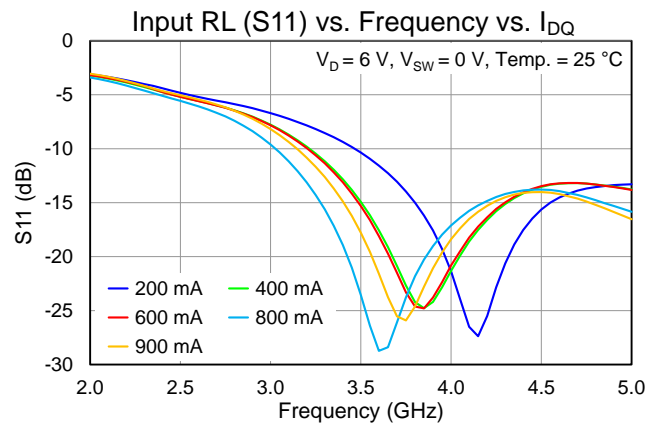
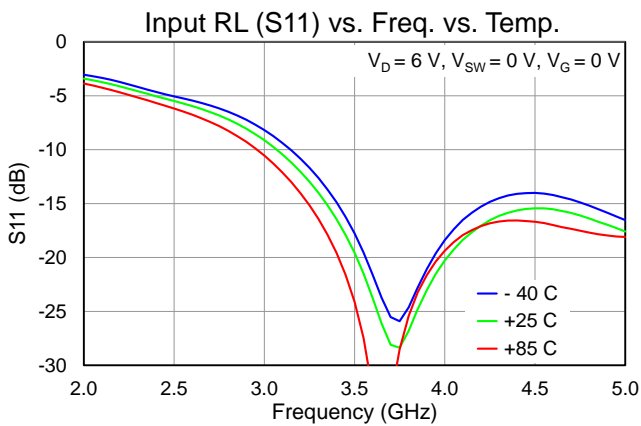
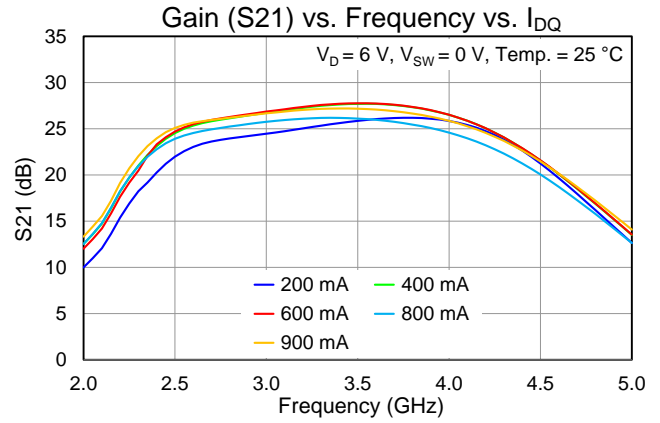
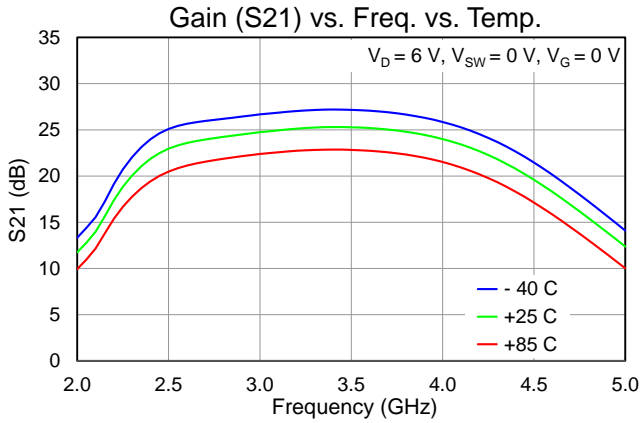

Typical Performance – (Small Signal)

Test conditions, unless otherwise noted: T = 25 °C, part mounted to EVB

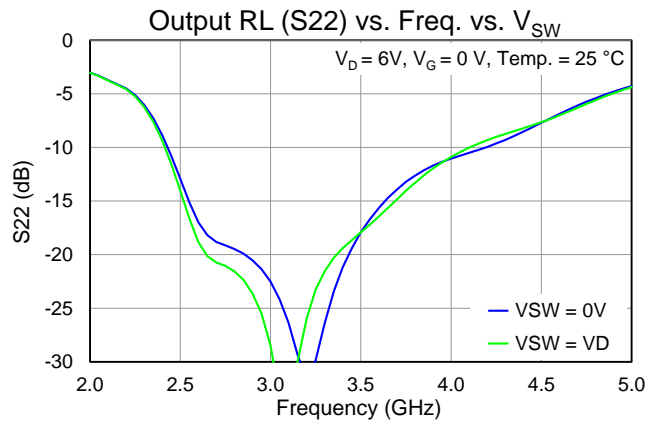
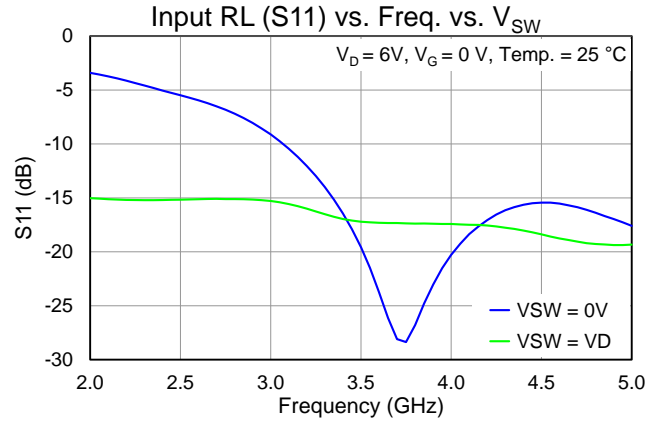
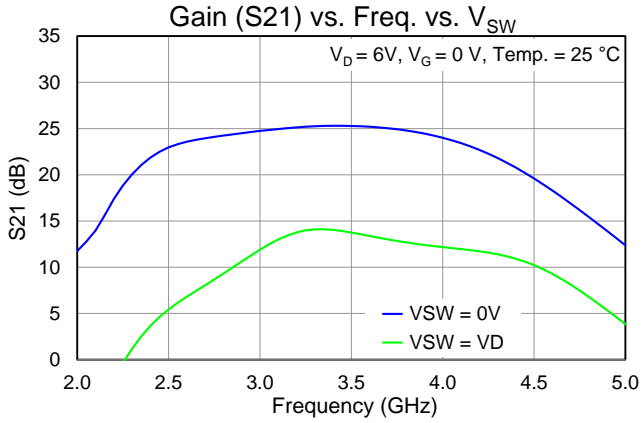

Typical Performance – Large Signal (Pulsed)

Test conditions, unless otherwise noted: T = 25 °C, part mounted to EVB, Pulse Power: PW = 100 us, DC = 20%

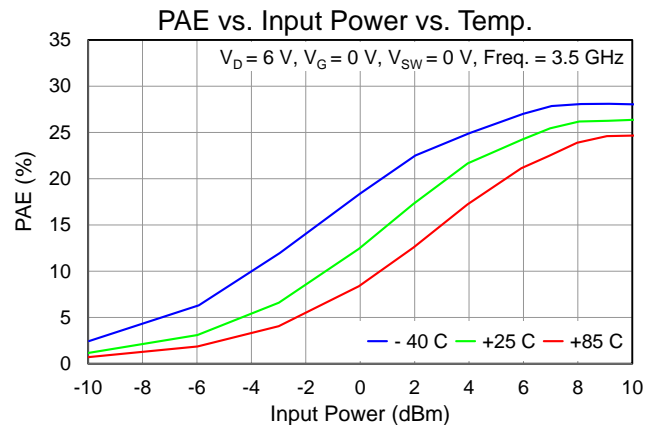
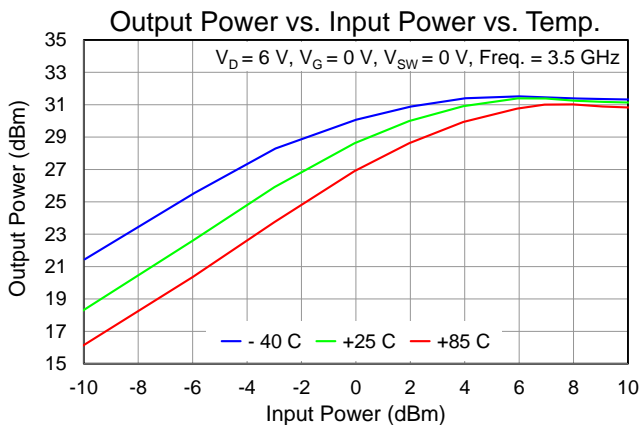
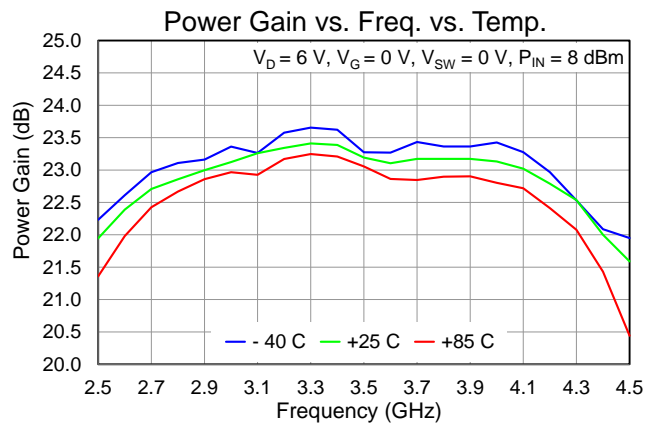
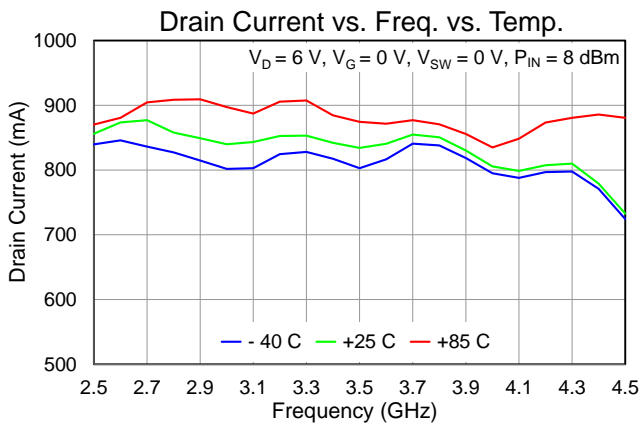
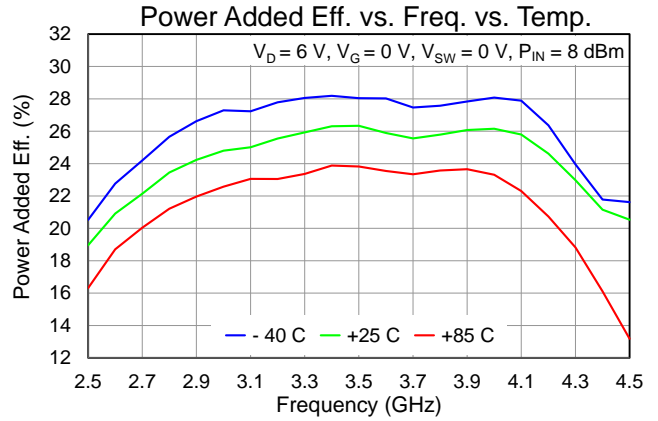
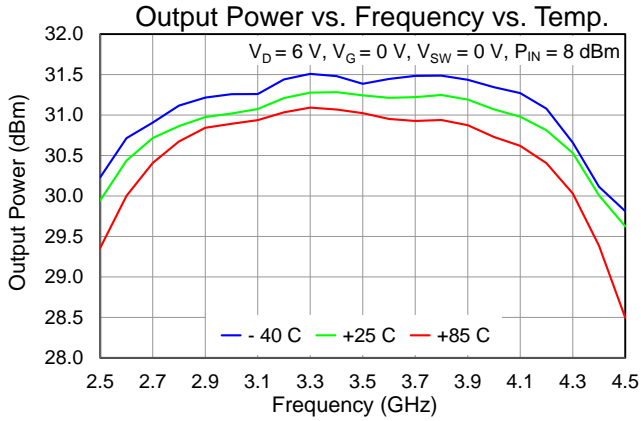

Typical Performance – Large Signal (Pulsed)

Test conditions, unless otherwise noted: T = 25 °C, part mounted to EVB, Pulse Power: PW = 100 us, DC = 20%

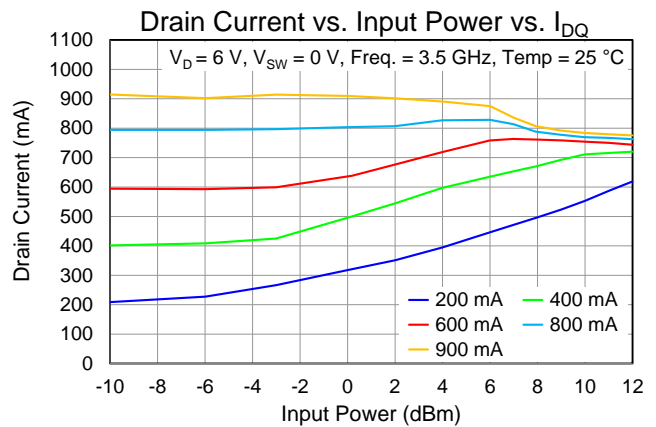
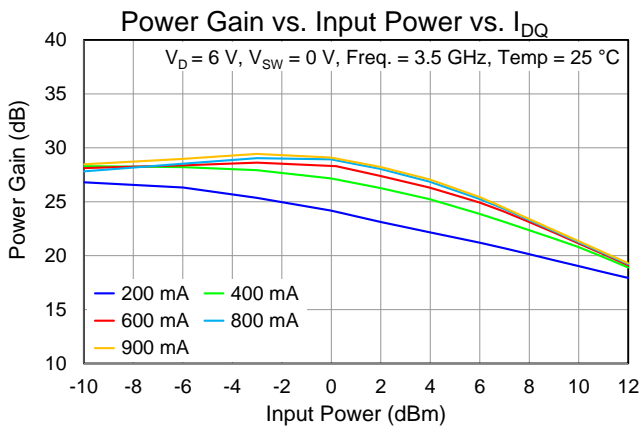
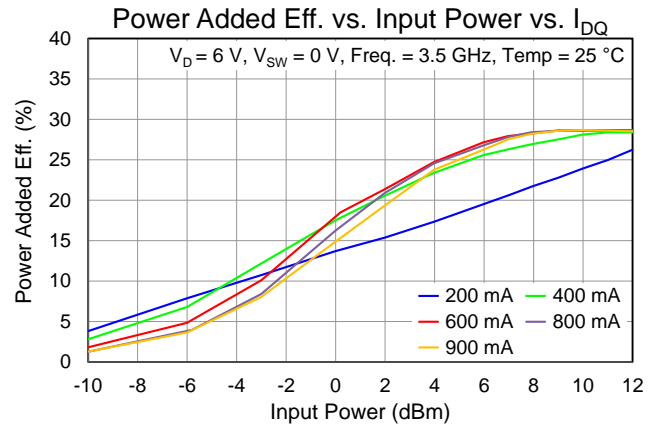
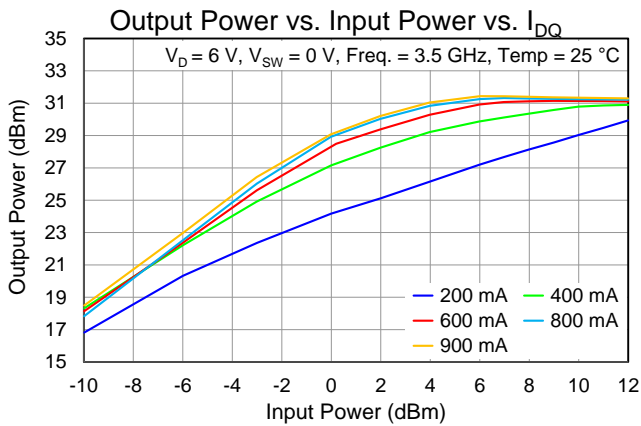
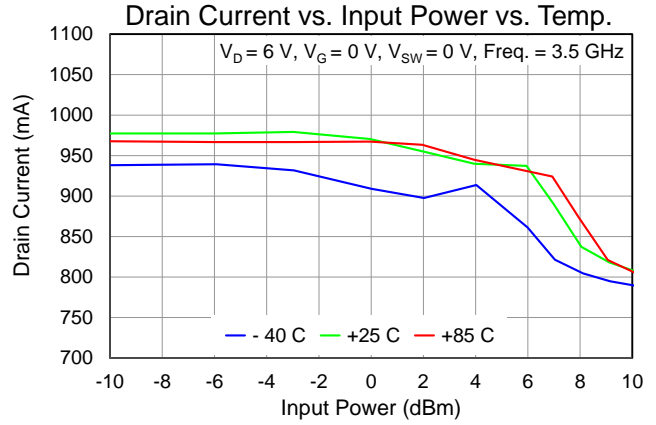
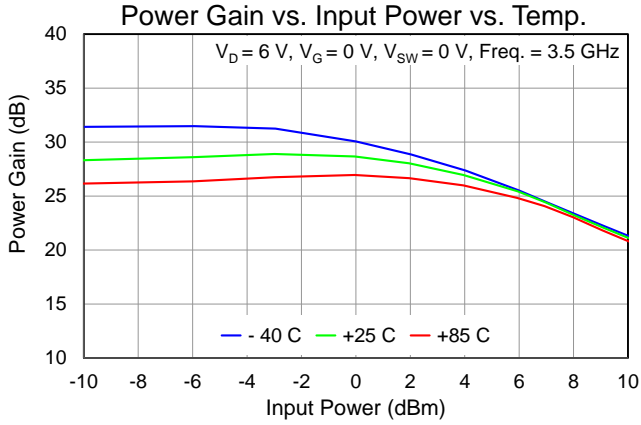

Typical Performance - Linearity

Test conditions, unless otherwise noted: T = 25 °C, V_{SW} = 0 V, part mounted to EVB

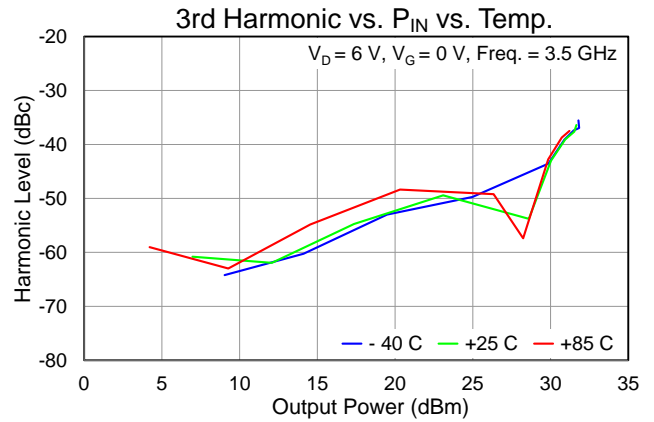
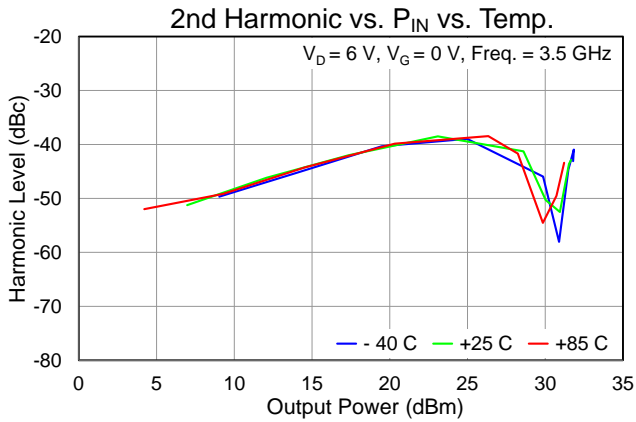
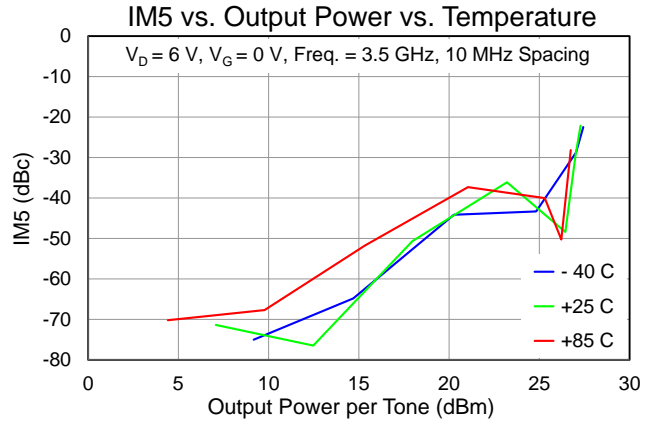
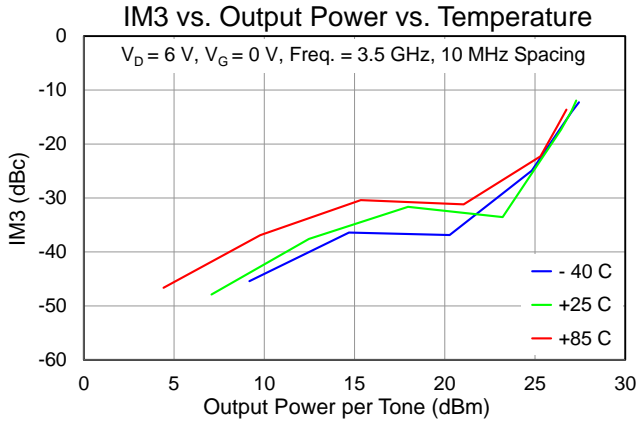

Thermal and Reliability Information

Parameter	Conditions	Value	Units
Thermal Resistance (θ_{JC}) ⁽¹⁾	T _{BASE} = 85 °C, V _D = 6 V, V _G = 0 V, I _{D_DRIVE} = 900 mA, Pulse Power Conditions: Pulse Width = 100 us, Duty Cycle = 10%, P _{IN} = 6 dBm, P _{OUT} = 30.8 dBm, P _{DISS(PULSE)} = 4.45 W	10.4	°C/W
Channel Temperature (T _{CH}) ⁽¹⁾		131.2	°C

Notes:

1. Package backside temperature fixed at 85 °C

Dissipated Power and Median Lifetime

Test conditions, unless otherwise noted: T = 25 °C, V_{SW} = 0 V, part mounted to EVB

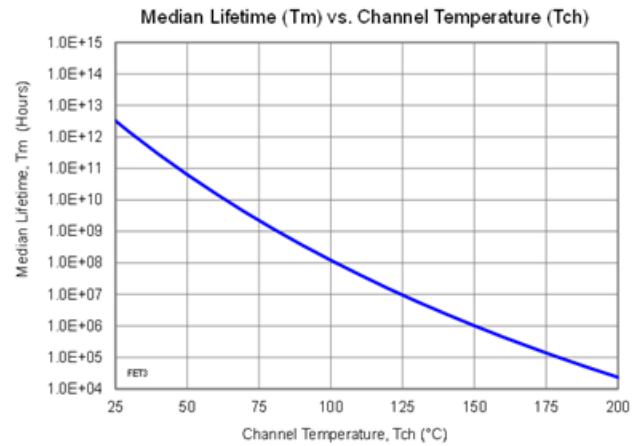
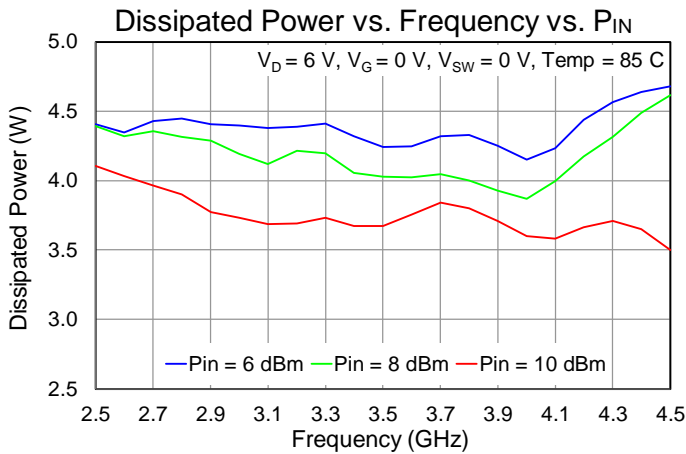

Test Conditions: 10 V; Failure Criterion = 10% reduction in I_{D_MAX}

Application Circuit

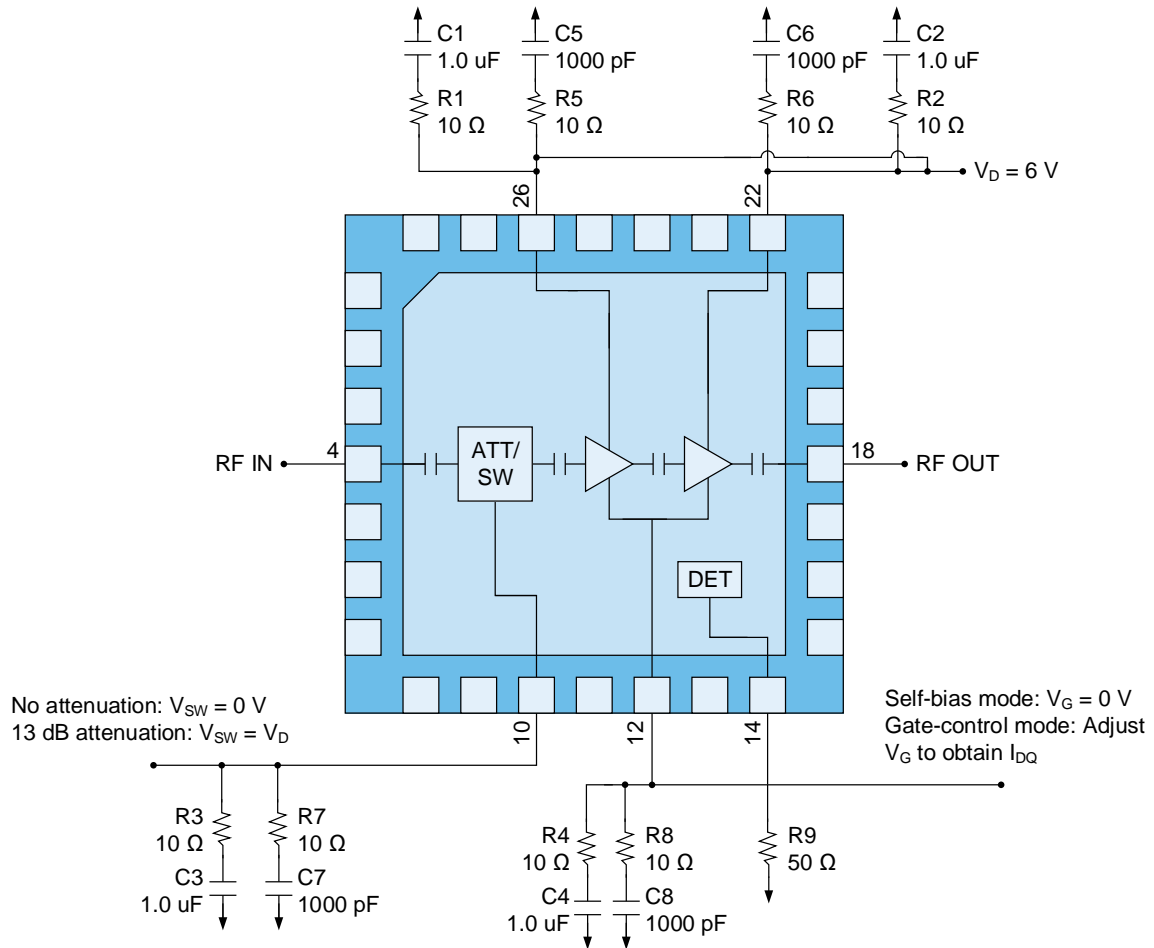

Bias-up Procedure

- Set ID limit to 1000 mA, I_G limit to 12 mA
- Self-biased mode: Set V_G to 0 V
- Gate-control mode: Adjust V_G to obtain desired I_{DQ}
- Increase V_D to +6 V
- Apply RF signal

Bias-down Procedure

- Turn off RF signal
- Set V_D to 0 V. Ensure I_{DQ} ~ 0 mA
- Turn off V_D supply
- Turn off V_G, V_{SW} supply

Evaluation Board Layout

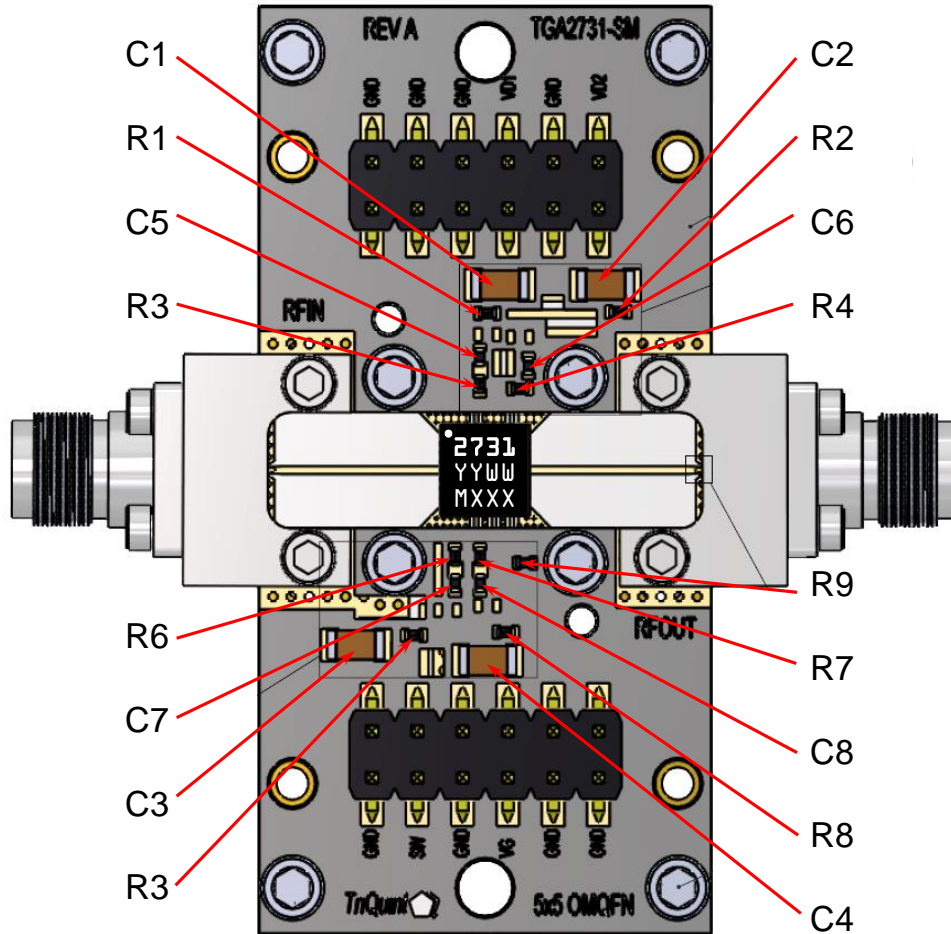

RF Layer is 0.008" thick Rogers Corp. RO4003C, $\epsilon_r = 3.38$. Metal layers are 0.5 oz. copper. The microstrip line at the connector interface is optimized for the Southwest Microwave end launch connector 1092-01A-5.

The pad pattern shown has been developed and tested for optimized assembly at Qorvo Semiconductor. The PCB land pattern has been developed to accommodate lead and package tolerances. Since surface mount processes vary from company to company, careful process development is recommended.

Bill of Materials

Reference Des.	Value	Description	Manuf.	Part Number
C1–C4	1.0 uF	Cap., 50 V, 10% X5R, 1206 case	Various	
C5–C8	1000 pF	Cap., 50 V, 10% X7R, 0402 case	Various	
R1–R8	10 Ohms	Resistor, 0402 case	Various	
R9	50 Ohms	Resistor, 0402 case	Various	

Mounting Detail

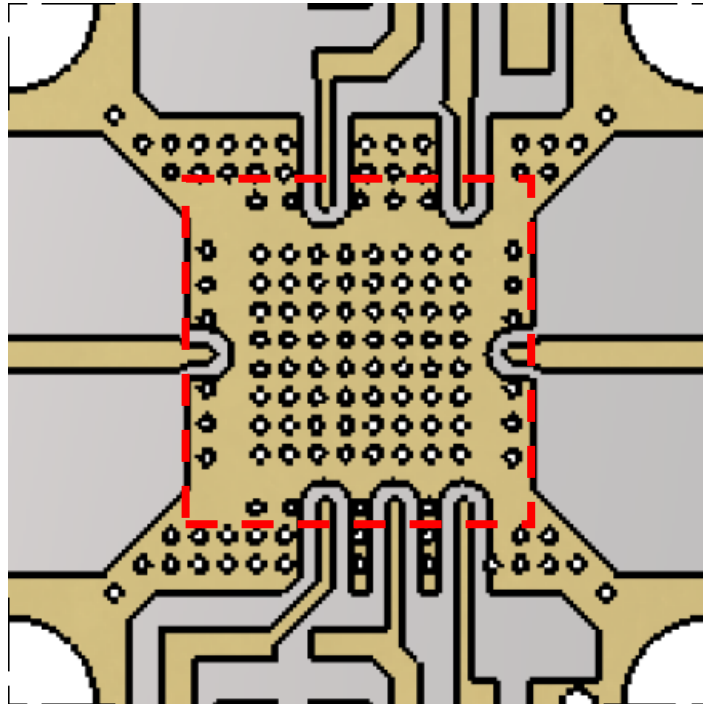

Notes:

1. Multiple copper filled vias are preferred for optimum thermal performance and to minimize inductance to ground.

Mechanical Information

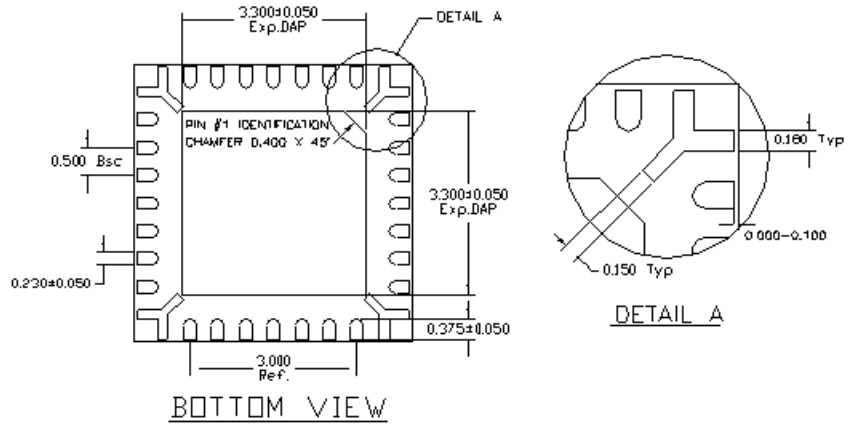
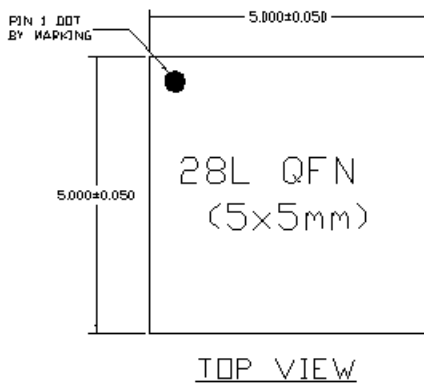

		QFN
A	MAX.	0.900
	NOM.	0.850
	MIN.	0.800

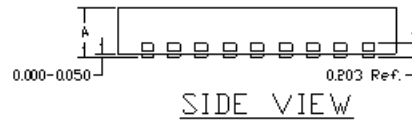

The TGA2731-SM will be marked with the “ZZZZ” and “YYWW” designators and a lot code marked below the part designator. Here, the “ZZZZ” will be “2731”. The “YY” represents the last two digits of the year the part was manufactured, the “WW” is the work week, and the “XXXX” is an auto-generated number.

This package is lead-free/RoHS-compliant. This package is compatible with both lead free and tin-lead soldering processes.

Dimensions are in millimeters.

Pad Description

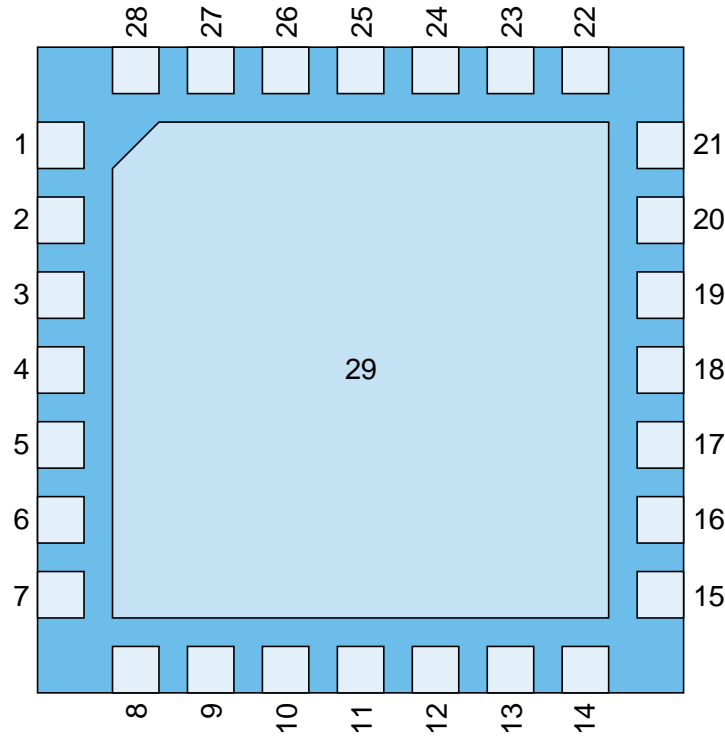

Bottom view of package base .

Pin Number	Label	Description
1-3, 5-9, 11 13, 15-17, 19-21, 23-25, 27-28	No Connect	No internal connection. Pads on PCB should be grounded to improve RF isolation
4	RF Input	RF input, matched to 50 Ω , DC blocked
10	V_{SW}	Input attenuator switch control voltage for gain control
12	V_G	Gate voltage
14	Power Sample	Coupled output power
18	RF Output	RF output, matched to 50 Ω , DC blocked
22	V_{D2}	Second stage drain voltage. Bias network required
26	V_{D1}	First stage drain voltage. Bias network required
29	GND	Ground paddle; must be grounded using plated through/copper filled via holes on PCB to improve isolation and for heat sinking

Recommended Soldering Temperature Profile

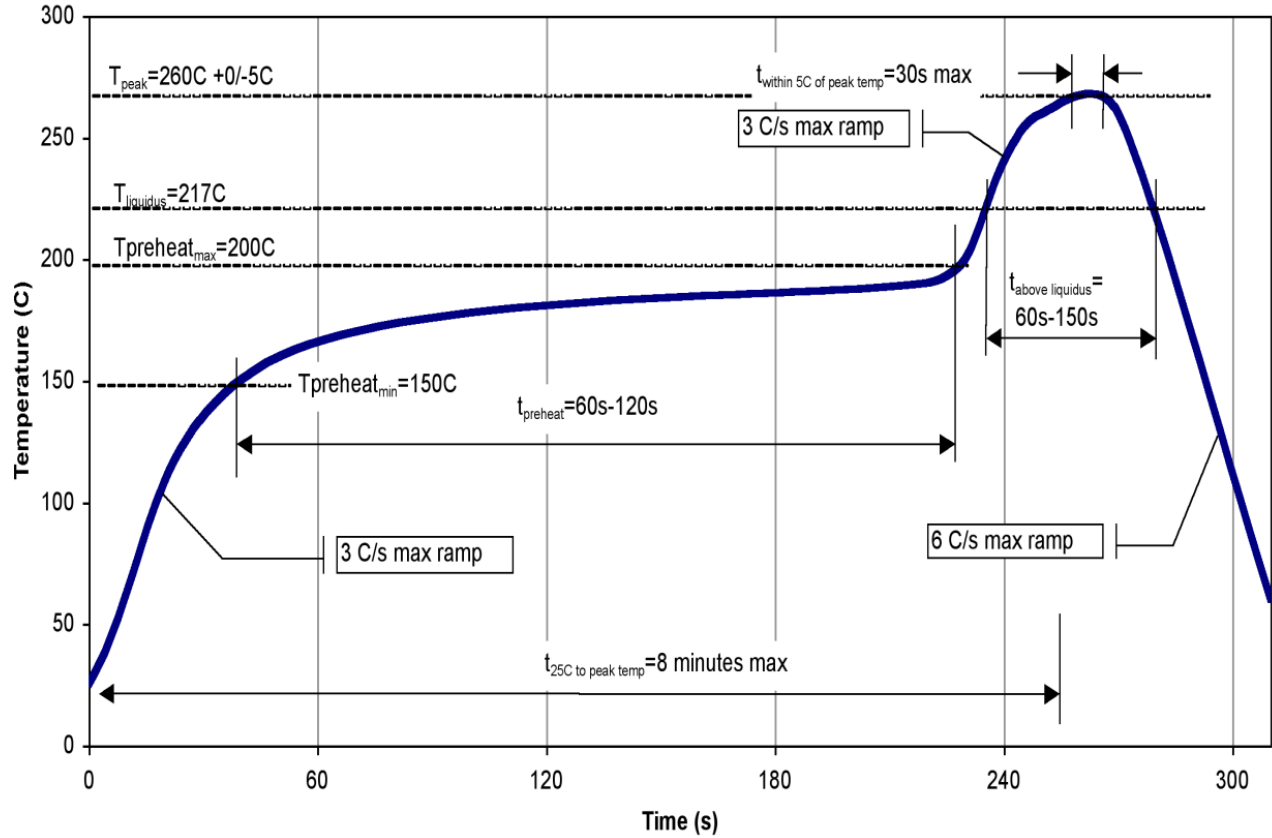

Handling Precautions

Parameter	Rating	Standard
ESD – Human Body Model (HBM)	1A	JEDEC/JESD22-A114
MSL – Moisture Sensitivity Level	MSL3	JEDEC/IPC/JEDEC J-STD-020



Caution!
 ESD-Sensitive Device

Solderability

Compatible with the latest version of J-STD-020 Lead free solder, 260 °C.

RoHS Compliance

This part is compliant with 2011/65/EU RoHS directive (Restrictions on the Use of Certain Hazardous Substances in Electrical and Electronic Equipment) as amended by Directive 2015/863/EU.

This product also has the following attributes:

- Lead Free
- Halogen Free (Chlorine, Bromine)
- Antimony Free
- TBBP-A (C₁₅H₁₂Br₄O₂) Free
- PFOS Free
- SVHC Free

Contact Information

For the latest specifications, additional product information, worldwide sales and distribution locations, and information about Qorvo:

Web: www.qorvo.com

Tel: 1-844-890-8163

Email: customer.support@qorvo.com

Important Notice



The information contained herein is believed to be reliable; however, Qorvo makes no warranties regarding the information contained herein and assumes no responsibility or liability whatsoever for the use of the information contained herein. All information contained herein is subject to change without notice. Customers should obtain and verify the latest relevant information before placing orders for Qorvo products. The information contained herein or any use of such information does not grant, explicitly or implicitly, to any party any patent rights, licenses, or any other intellectual property rights, whether with regard to such information itself or anything described by such information. **THIS INFORMATION DOES NOT CONSTITUTE A WARRANTY WITH RESPECT TO THE PRODUCTS DESCRIBED HEREIN, AND QORVO HEREBY DISCLAIMS ANY AND ALL WARRANTIES WITH RESPECT TO SUCH PRODUCTS WHETHER EXPRESS OR IMPLIED BY LAW, COURSE OF DEALING, COURSE OF PERFORMANCE, USAGE OF TRADE OR OTHERWISE, INCLUDING THE IMPLIED WARRANTIES OF MERCHANTABILITY AND FITNESS FOR A PARTICULAR PURPOSE.**

Without limiting the generality of the foregoing, Qorvo products are not warranted or authorized for use as critical components in medical, life-saving, or life-sustaining applications, or other applications where a failure would reasonably be expected to cause severe personal injury or death.

Copyright 2019 © Qorvo, Inc. | Qorvo is a registered trademark of Qorvo, Inc.

Looking for pricing, stock, or lifecycle information?

Click below to explore more details on WIN SOURCE:

-  [View TGA2731-SM on WIN SOURCE](#)
-  [Qorvo US Inc. Information](#)

Optimize Your Supply Chain with WIN SOURCE Solutions

-  Global Sourcing Solution
-  Obsolete Management
-  Cost Control Management
-  Shortage Management
-  Alternative Solution
-  Excess Inventory Management