



## MMIC SURFACE MOUNT

# Low Noise Amplifier

## PMA1-14LN+

50Ω 0.05 to 10 GHz Wideband Amplifier

### THE BIG DEAL

- Low Noise Figure, Typ. 1.1 dB
- High OIP3, Typ. +28.8 dBm
- High P1dB, Typ. +21.5 dBm
- Single Supply Voltage, +6 V at 61 mA
- 1.5x1.5 mm 6-Lead QFN-Style Package

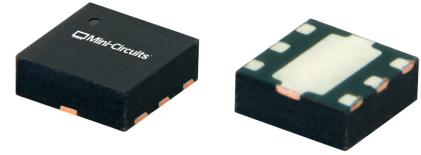

Generic photo used for illustration purposes only

### APPLICATIONS

- Test and Measurement Equipment
- 5G MIMO and Back Haul Radio
- Satellite Communication
- Radar, EW, and ECM Defense Systems

### FUNCTIONAL DIAGRAM

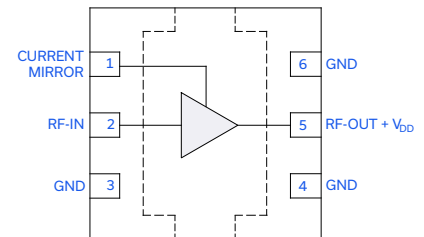

### PRODUCT OVERVIEW

The PMA1-14LN+ is a pHEMT-based low noise MMIC amplifier with high IP3 and flat gain. Operating from 0.05 to 10 GHz, this amplifier features high dynamic range with typical 1.1 dB noise figure, 22 dB gain, +21.5 dBm P1dB, and +28.8 dBm OIP3. This combination of performance makes it ideal for sensitive high dynamic range receiver applications. PMA1-14LN+ operates from a single +6 V supply, is well matched to 50Ω, and comes in a very small, low profile 1.5x1.5 mm QFN-style package for easy integration into dense circuit board layouts.

### KEY FEATURES

Features	Advantages
Low Noise Figure, Typ. 1.1 dB	A 50Ω matched low noise MMIC device enables low system noise figure performance without the need for complicated discrete-based solutions.
Low Power Consumption, Typ. +6 V at 61 mA	At only 61 mA, this amplifier is ideal for applications with limited available power or densely packed applications where thermal and power management is critical.
1.5x1.5mm 6-Lead QFN-Style Package	Very small footprint saves space in dense PCB layouts while providing low inductance, repeatable transitions, and excellent thermal contact with the PCB. Industry standard packaging allows for easy assembly in high volume manufacturing processes.



MMIC SURFACE MOUNT

# Low Noise Amplifier

## PMA1-14LN+

50Ω 0.05 to 10 GHz Wideband Amplifier

### ELECTRICAL SPECIFICATIONS<sup>1</sup> AT 25°C, V<sub>DD</sub> = +6 V, Z<sub>0</sub> = 50Ω UNLESS NOTED OTHERWISE

Parameter	Condition (GHz)	Min.	Typ.	Max.	Units
Frequency Range		0.05		10	GHz
Gain	0.05	21.0	21.8		dB
	2	21.0	22.0		
	4	20.9	22.0		
	8	21.1	22.3		
	10	21.1	22.3		
Input Return Loss	0.05		20		dB
	2		15		
	4		13		
	8		8		
	10		15		
Output Return Loss	0.05		21		dB
	2		19		
	4		16		
	8		11		
	10		8		
Isolation	0.05 - 10		27		dB
Output Power at 1dB Compression (P <sub>1dB</sub> )	0.05		+21.2		dBm
	2		+22.8		
	4		+21.5		
	8		+20.6		
	10		+19.6		
Output Third-Order Intercept Point (P <sub>OUT</sub> = +5 dBm/Tone)	0.05		+30.9		dBm
	2		+29.9		
	4		+28.8		
	8		+27.8		
	10		+26.5		
Noise Figure	0.05		1.6		dB
	2		1.1		
	4		1.1		
	8		1.3		
	10		1.8		
Device Operating Voltage (V <sub>DD</sub> )		+5.75	+6.0	+6.25	V
Device Operating Current (I <sub>DD</sub> ) <sup>2</sup>			61		mA
DC Current Variation vs. Temperature <sup>3</sup>			-76.9		μA/°C
DC Current Variation vs. Voltage <sup>4</sup>			29.6		μA/mV

1. Tested on Mini-Circuits Characterization Test Board TB-PMA1-14LNC+. See Figure 2. Board loss de-embedded to the device.

2. Current at P<sub>IN</sub> = -25 dBm. Increases to 89 mA at P<sub>1dB</sub>.

3. (Current at +85°C - Current at -45°C) / (+85°C - -45°C)

4. (Current at +6.25 V - Current at +5.75 V) / (+6.25 V - +5.75 V)



### TYPICAL PERFORMANCE GRAPHS

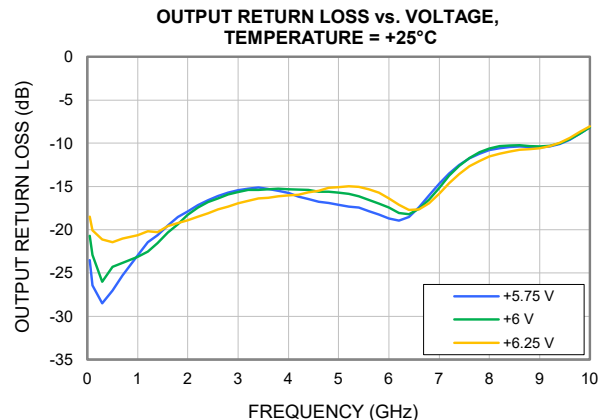
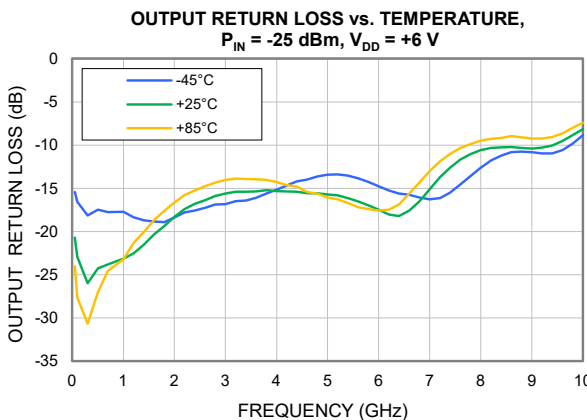
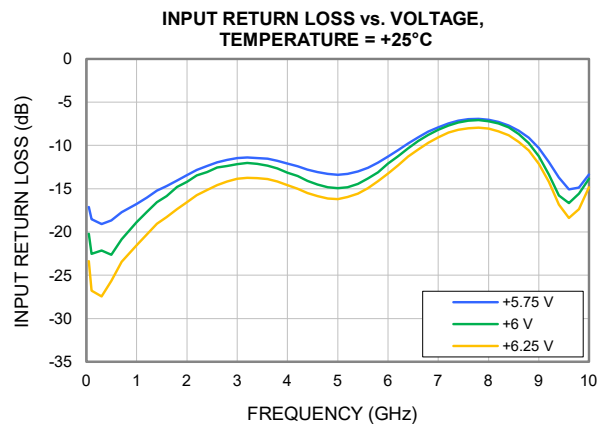
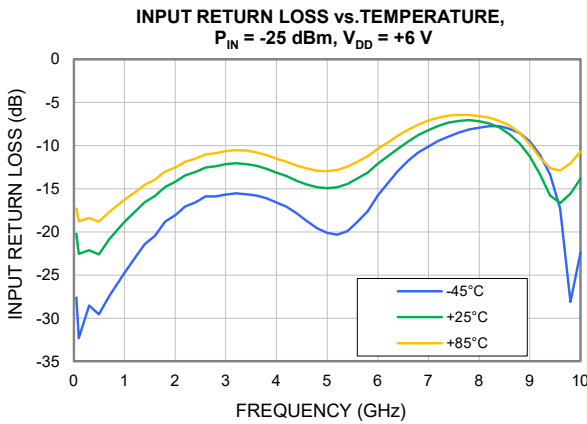
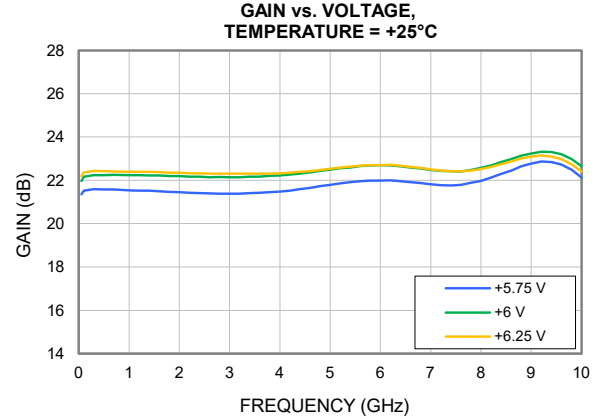
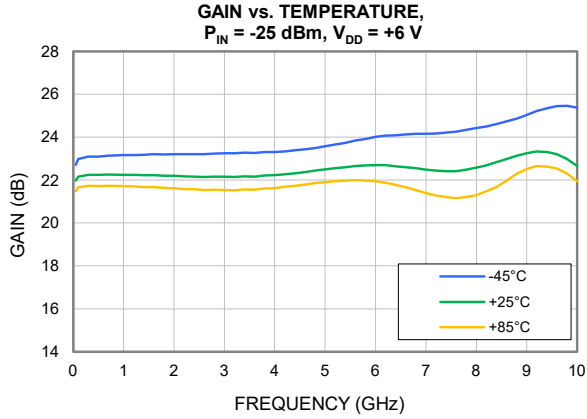



### TYPICAL PERFORMANCE GRAPHS

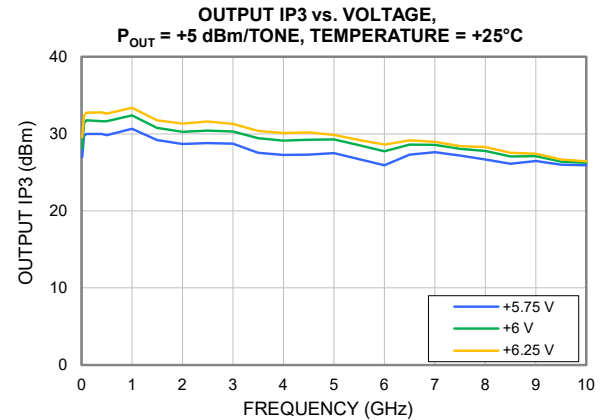
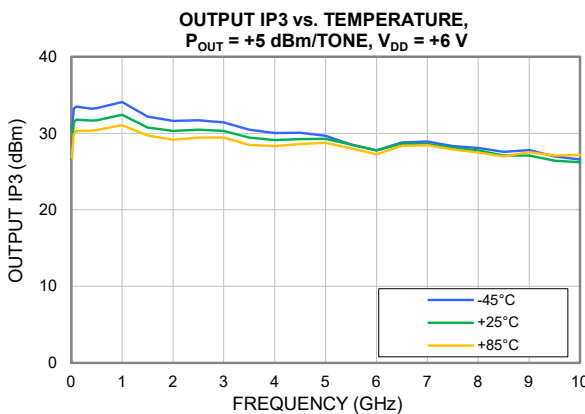
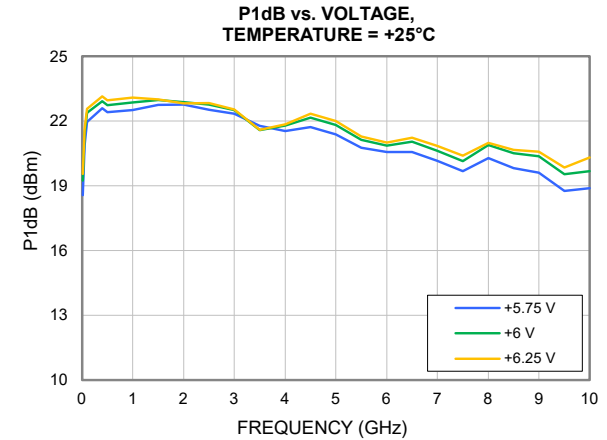
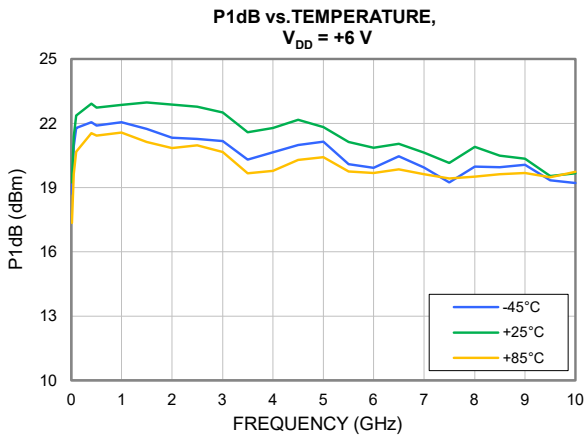
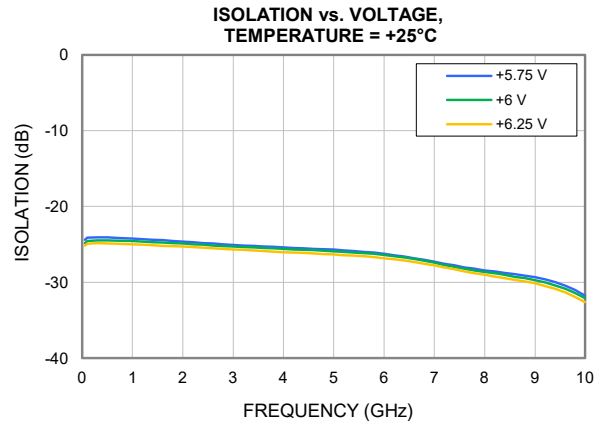
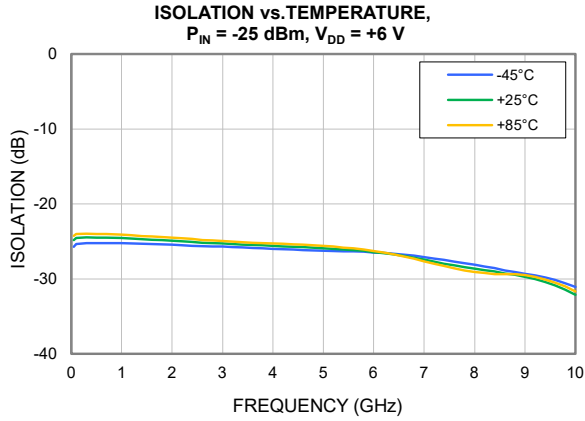



### TYPICAL PERFORMANCE GRAPHS

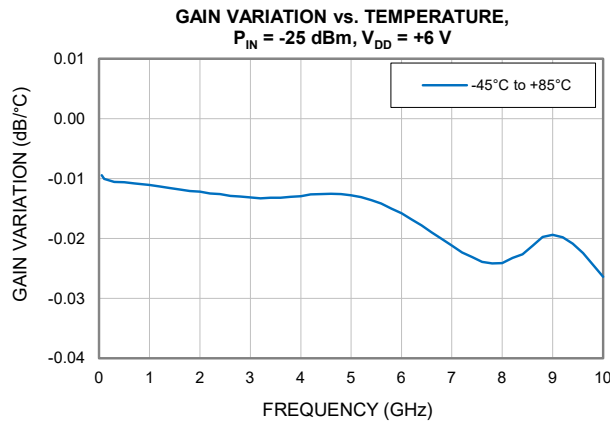
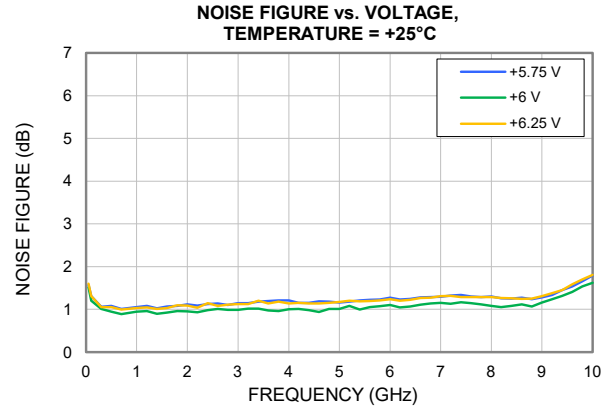
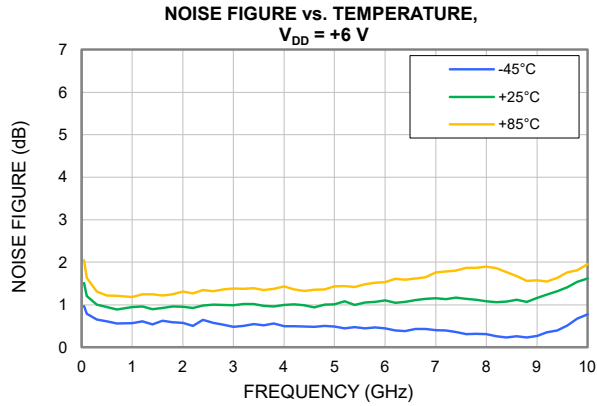



## MMIC SURFACE MOUNT

# Low Noise Amplifier

## PMA1-14LN+

50Ω 0.05 to 10 GHz Wideband Amplifier

### ABSOLUTE MAXIMUM RATINGS<sup>5</sup>

Parameter	Ratings
Operating Temperature	-45°C to +85°C
Storage Temperature	-65°C to +150°C
Junction Temperature <sup>6</sup>	+150°C
Total Power Dissipation	1.18 W
Input Power (CW), $V_{DD} = +6 V$	+25 dBm
DC Voltage at $V_{DD}$	+9 V
DC Current $I_{DD}$	140 mA

5. Permanent damage may occur if any of these limits are exceeded. Maximum ratings are not intended for continuous normal operation.

6. Peak temperature on top of Die.

### THERMAL RESISTANCE

Parameter	Ratings
Thermal Resistance ( $\Theta_{JC}$ ) <sup>7</sup>	54.9°C/W

7.  $\Theta_{JC}$  = (Hot Spot Temperature on Die - Temperature at Ground Lead)/Dissipated Power

### ESD RATING

	Class	Voltage Range	Reference Standard
HBM	1B	500 V to < 1000 V	ANSI/ESDA/JEDEC JS-001-2023
CDM	C3	> 1000 V	ANSI/ESDA/JEDEC JS-002-2022



ESD HANDLING PRECAUTION: This device is designed to be Class 1B for HBM. Static charges may easily produce potentials higher than this with improper handling and can discharge into DUT and damage it. As a preventive measure Industry standard ESD handling precautions should be used at all times to protect the device from ESD damage.

### MSL RATING

Moisture Sensitivity: MSL1 in accordance with IPC/JEDEC J-STD-020E /JEDEC J-STD-033C





### FUNCTIONAL DIAGRAM

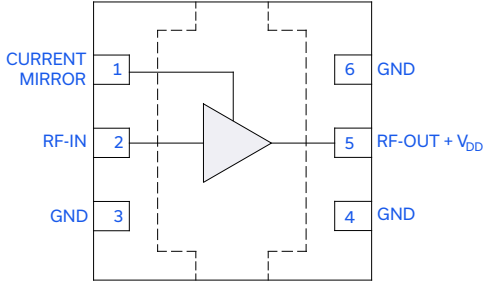

Figure 1. PMA1-14LN+ Functional Diagram

### PAD DESCRIPTION

Function	Pad Number	Description (Refer to Figure 2)
RF-IN	2	RF-IN Pad connects to RF Input port.
RF-OUT+V <sub>DD</sub>	5	RF-OUT Pad connects to RF Output port. V <sub>DD</sub> is applied via external bias tee.
CURRENT MIRROR <sup>8</sup>	1	Current Mirror Pad. Supplies gate voltage to RF-IN via L1. See details in Figure 2
GND	3, 4, 6 & Paddle	Connects to ground.

<sup>8</sup>. To achieve specified performance, follow the current mirror circuit described in Figure 2. A feedback loop to RF-IN must be present for the part to operate.

### CHARACTERIZATION TEST BOARD

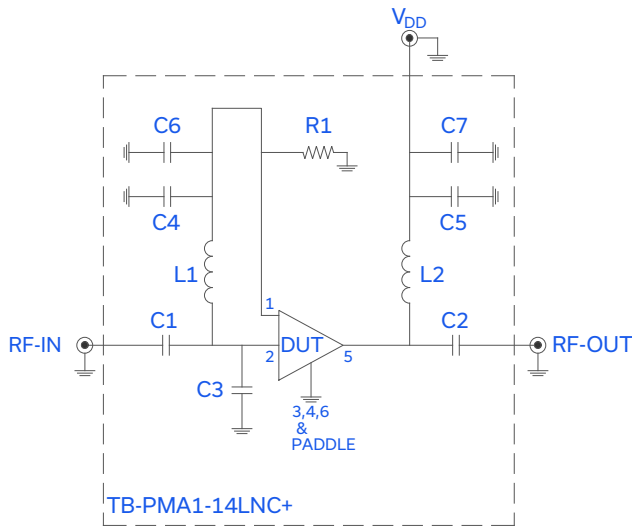

Figure 2. PMA1-14LN+ Characterization and Application Circuit.

### Electrical Parameters and Conditions

Gain, Return Loss, Output Power at 1dB Compression (P1dB), Output IP3 (OIP3), and Noise Figure measured using N5242A PNA-X microwave network analyzer.

Conditions:

- 1) Gain and Return Loss: P<sub>IN</sub> = -25 dBm
- 2) Output IP3 (OIP3): Two tones, spaced 1 MHz apart, +5 dBm/Tone at output.
- 3) V<sub>DD</sub> = +6 V

Component	Value	Size	Part Number	Manufacturer
C1, C2	0.01 μF	0402	GRM155R71H103KA88	Murata
C3	0.2 pF	0402	GJM1555C1HR20WB01D	Murata
C4, C5	100 pF	0402	GRM1555C1H101JA01D	Murata
C6, C7	0.1 μF	0402	GRM155R71H104KE14J	Murata
L1 <sup>8</sup> , L2	900 nH	0402	0402DF-901XJRU	Coilcraft
R1	510 Ω	0402	RK73H1ETTP5100F	KOA Speer



### CASE STYLE DRAWING

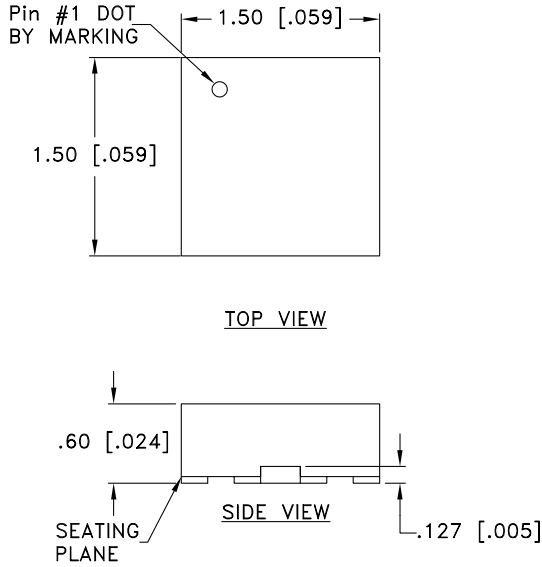

### PCB Land Pattern

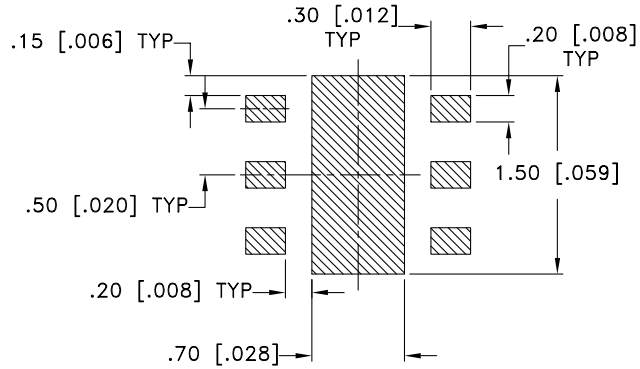

Suggested Layout,  
Tolerance to be within ±0.050 mm

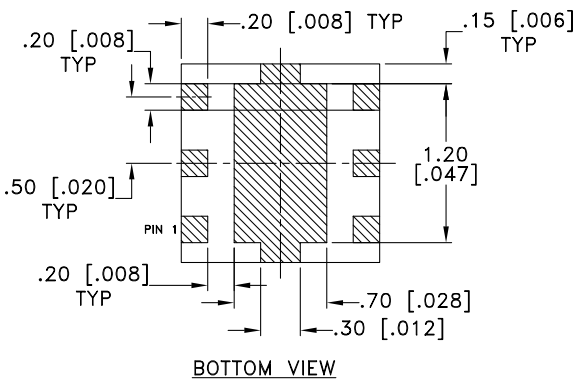

### NOTES:

1. DENOTES METALLIZATION

Weight: .0036 grams

Dimensions are in mm [inches]. Tolerances: 2 Pl.± 0.05 mm

### PRODUCT MARKING

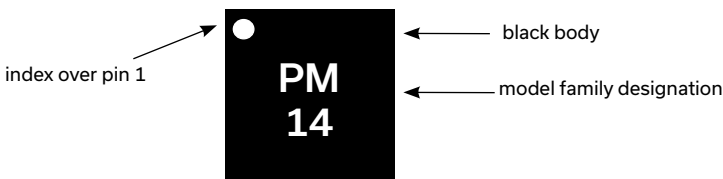

Marking may contain other features or characters for internal lot control



MMIC SURFACE MOUNT

# Low Noise Amplifier

## PMA1-14LN+

50Ω 0.05 to 10 GHz Wideband Amplifier

ADDITIONAL DETAILED INFORMATION IS AVAILABLE ON OUR DASHBOARD

[CLICK HERE](#)

Performance Data & Graphs	Data Graphs S-Parameter (S2P Files) Data Set (.zip file)
Case Style	KC3009 Plastic package, exposed paddle, Lead Finish: Nickel-Palladium-Gold
RoHS Status	Compliant
Tape & Reel Standard quantities available on reel	F66 7" reels with 20, 50, 100, 200, 500, 1000, 2000, or 3000 devices
Suggested Layout for PCB Design	PL-803
Evaluation Board	TB-PMA1-14LNC+ Gerber File
Environmental Ratings	ENV08T1

Notes

- A. Performance and quality attributes and conditions not expressly stated in this specification document are intended to be excluded and do not form a part of this specification document.
- B. Electrical specifications and performance data contained in this specification document are based on Mini-Circuits' applicable established test performance criteria and measurement instructions.
- C. The parts covered by this specification document are subject to Mini-Circuits' standard limited warranty and terms and conditions (collectively, "Standard Terms"; Purchasers of this part are entitled to the rights and benefits contained therein. For a full statement of the standard terms and the exclusive rights and remedies thereunder, please visit Mini-Circuits' website at <https://www.minicircuits.com/terms/viewterm.html>



## Looking for pricing, stock, or lifecycle information?

Click below to explore more details on WIN SOURCE:

 [View PMA1-14LN+ on WIN SOURCE](#)

 [Mini-Circuits Information](#)

## Optimize Your Supply Chain with WIN SOURCE Solutions

-  Global Sourcing Solution
-  Obsolete Management
-  Cost Control Management
-  Shortage Management
-  Alternative Solution
-  Excess Inventory Management