

Product Overview

The QPL1811 is a high performance broadband DOCSIS 4.0 MMIC amplifier designed with GaAs pHEMT technology optimized for low noise and high linearity. A Darlington configuration is utilized for broadband performance with on-chip active bias circuit for consistent bias current and repeatable performance. The QPL1811 contains two amplifiers used in push-pull configuration for excellent second and third order linearity performance.



Package: SOIC-8

Functional Block Diagram

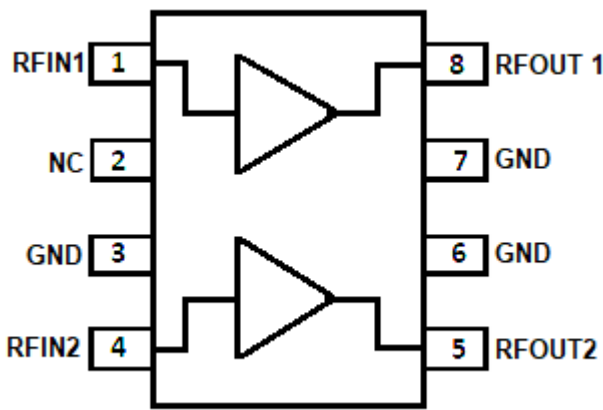

Key Features

- 5V to 7V Single Supply
- High Gain: 16dB @ 1800MHz
- OIP3: +42dBm
- P1dB: +24dBm
- Compact Size: 8-pin SOIC
- 50MHz to 1800MHz operation supporting DOCSIS 4.0
- pHEMT GaAs device technologies

Ordering Information

Part Number	Description
QPL1811SB	Sample bag with 5 pieces
QPL1811SR	7" Reel with 100 pieces
QPL1811TR13	13" Reel with 2500 pieces
QPL1811EVB-01	Evaluation Board

Applications

- Broadband CATV Amplifiers and Nodes
- CATV Line Driver Amplifier
- DOCSIS 4.0
- 75 Ohm Amplifiers

Absolute Maximum Ratings

Parameter	Rating	Unit
Supply Voltage (V_{DD})	9	Volts
Supply Current (I_{DD})	500	mA
Maximum RF Input Power	20	dBm
Maximum Junction Temperature	160	°C
Storage Temperature	-40 to +85	°C

Exceeding any one or a combination of the Absolute Maximum Rating conditions may cause permanent damage to the device. Extended application of Absolute Maximum Rating conditions to the device may reduce device reliability.

Electrical Specifications

Parameter	Condition ⁽¹⁾	Min	Typ	Max	Unit
Supply Voltage (V_{DD})		5	7	8	Volts
Supply Current (I_{DD})		140	290		mA
Frequency Range		50		1800	MHz
Gain	At 50MHz		15.2		dB
	At 1200MHz		16		dB
	At 1800MHz		16.4		dB
Gain Slope			1.2		dB
Reverse Isolation			20		dB
Input Return Loss			18		dB
Output Return Loss			18		dB
Noise Figure ⁽²⁾	At 1200MHz		3.5		dB
MER ⁽³⁾ At +64dBmV Total Composite Output power	At 111MHz		44		dB
	At 1302MHz		42		dB
	At 1698MHz		42		dB
OIP2	At 50MHz		70		dBm
	At 1200MHz		70		dBm
	At 1800MHz		70		dBm
OIP3	At 50MHz		43		dBm
	At 1200MHz		42		dBm
	At 1800MHz		38		dBm
Output P1dB			24		dBm
Thermal Resistance			32		°C/W

1. Typical performance at these conditions: Temp = +25°C, VDD = +7V, 75Ω system, Full band unless otherwise noted

2. Noise Figure of the part only. The input BALUN loss has been compensated.

3. 111MHz to 1791MHz, 0dB tilt, 149 Ch.+ 4 OFDM Ch. CCN Noise BW (ANSI/SCTE 17): 5.36MHz for J.83/B. Tx Data: ITU-T, Annex B, QAM256, 5.36 MSymbols/s

Evaluation Board Schematic 50 -1800MHz

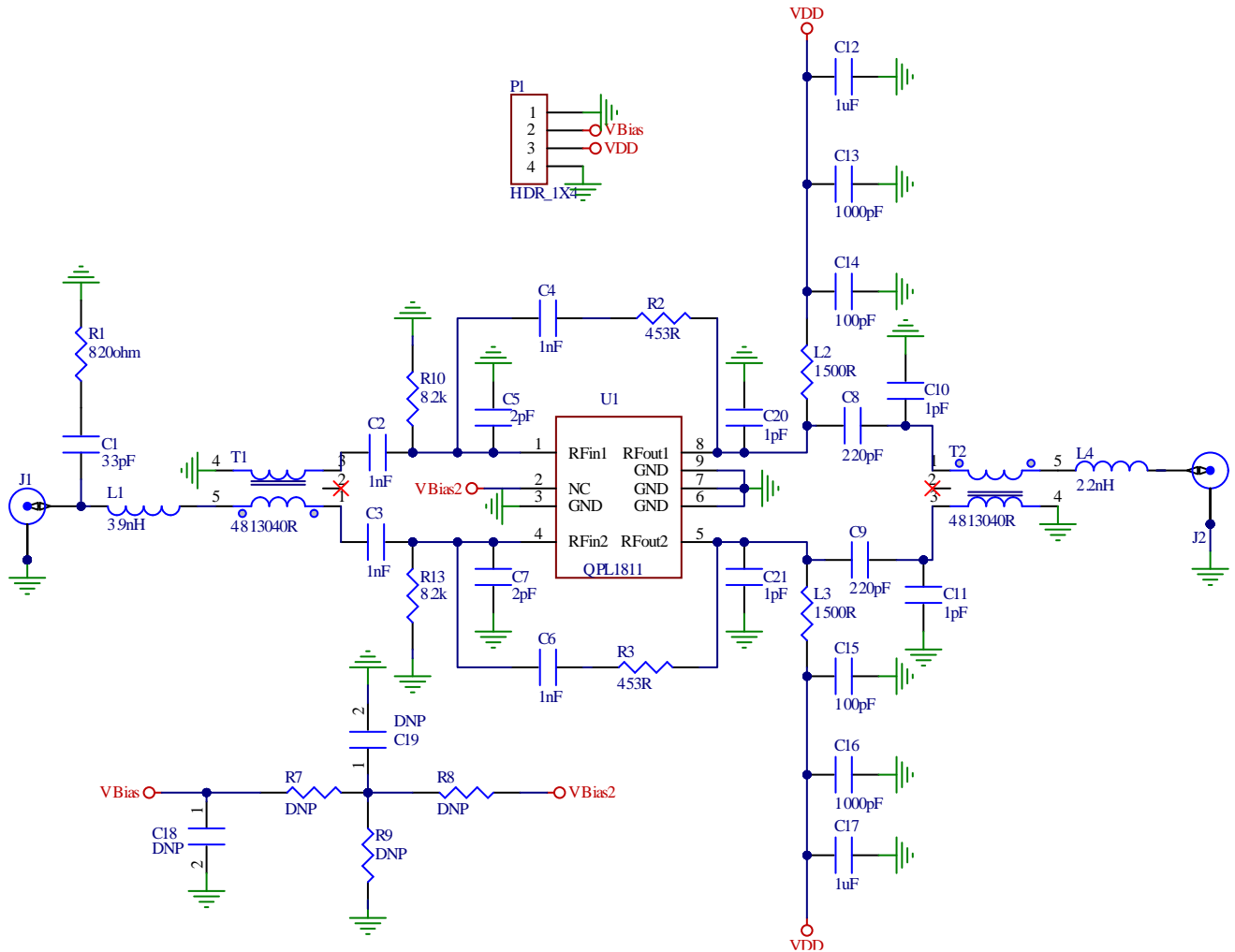



QPL1811

75Ω CATV Amplifier 50 – 1800MHz

Evaluation Board Bill of Material

Ref Des	Description	Qty	Mfg Name	Mfg Part #
U1	CATV Amplifier	1	Qorvo	QPL1811
PCB	PCB, QPL1811	1	Qorvo	QPL1811-4000
C13, C16	CAP, 1000pF, 10%, 50V, X7R, 0603	2	Johanson Technology	500R14W102KV4T
C8, C9	CAP, 220pF, 5%, 50V, C0G, 0603	2	Johanson Technology	500R14N221JV4
C5, C7	CAP, 2pF, +/-0.1pF, 50V, HI-Q, 0402	2	MURATA ELECTRONICS	GJM1555C1H2R0BB01D
C2, C3, C4, C6	CAP, 1000pF, 5%, 50V, C0G, 0402	4	MURATA ELECTRONICS	GRM1555C1H102JA01D
C14, C15	CAP, 100pF, 5%, 50V, C0G, 0603	2	AVX Asia Limited	06035A101JAT2A
C12, C17	CAP, 1uF, 10%, 50V, X5R, 0603	2	AVX Asia Limited	06035D105KAT2A
C10, C11, C20, C21	Cap, 1pF /0.1pF/0402/NP0/50V	4	Johanson Technology	
C1	Cap, 33pF /5%/0402/NP0/50V	1	Johanson Technology	
R1	RES, 820 OHM, 5%, 1/10W, 0402	1	Kamaya, Inc	RMC1/16S-821JTH
R2, R3	RES, 453 OHM, 1%, 1/10W, 0402	2	Panasonic	ERJ-2RKF4530X
R10, R13	Res, 8.2K/1%/0402	2	Kamaya, Inc	
L4	IND, 0402 TF 2.2nH	1	MURATA ELECTRONICS	LQP15MN2N2B02D
L1	IND, 3.9nH, +/-0.3nH, M/L, 0402	1	TAIYO YUDEN	LG HK10053N9S-T
L2, L3	FER, BEAD, 1500 OHM, 500mA, 0603	2	MURATA ELECTRONICS	BLM18HE152SN1D
T1, T2	XFMR, 1:1TLT, 4.5-3000 MHz, 75 Ohm	2	MINNTRONIX INC	4813040R
J1, J2	CONN, F, EDGE MOUNT, 60 MIL	2	Trompeter Electronics	CBJE130-1
P1	CONN, HDR, ST, 4-PIN, 0.100"	1	SAMTEC INC.	TSW-104-08-S-S
R7, R8, R9, C18, C19	NOT POPULATED ITEM	7		DUMMY PART

Evaluation Board Layout 50 -1800MHz

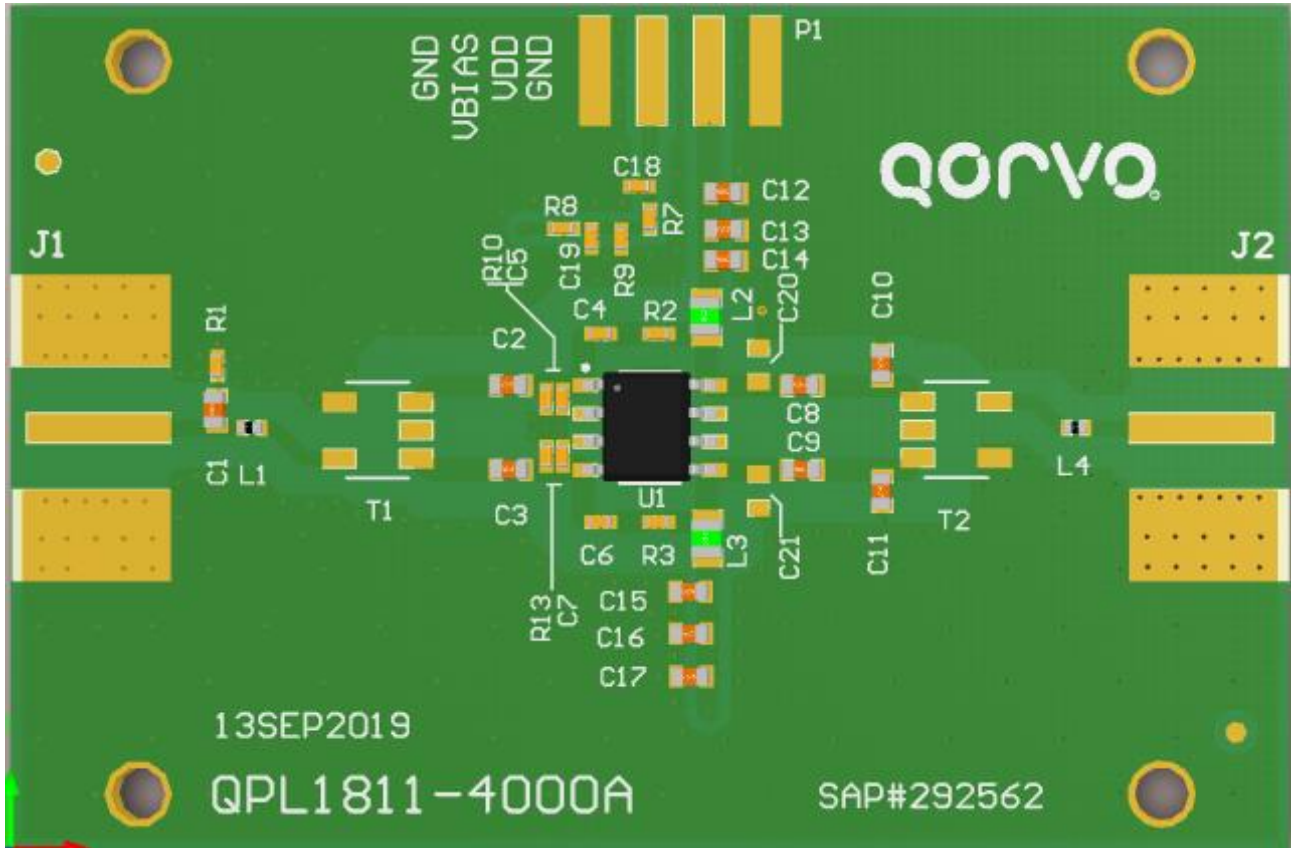

Evaluation Board PCB Material and Stack-up

4 Layer FR4 Board, 2.25inches X 1.5inches



Performance Data at +7V

Test conditions unless otherwise noted: Vdd = +7V, Temp = +25C, Zo = 75Ω

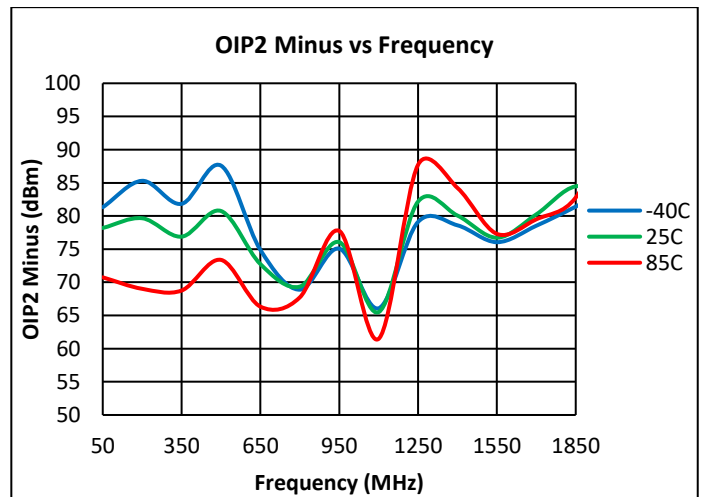
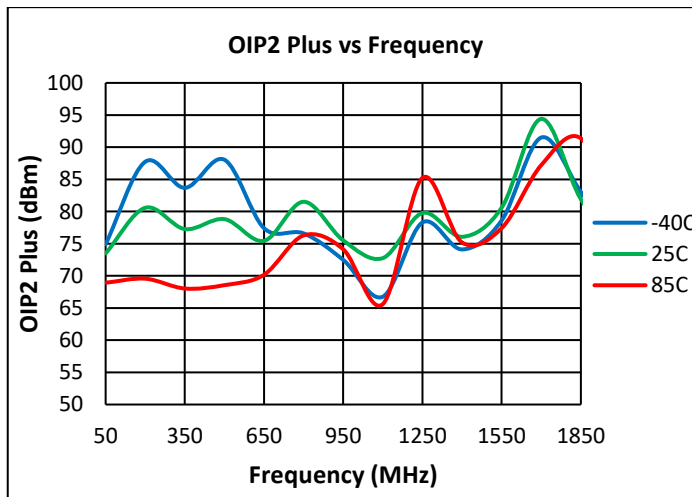
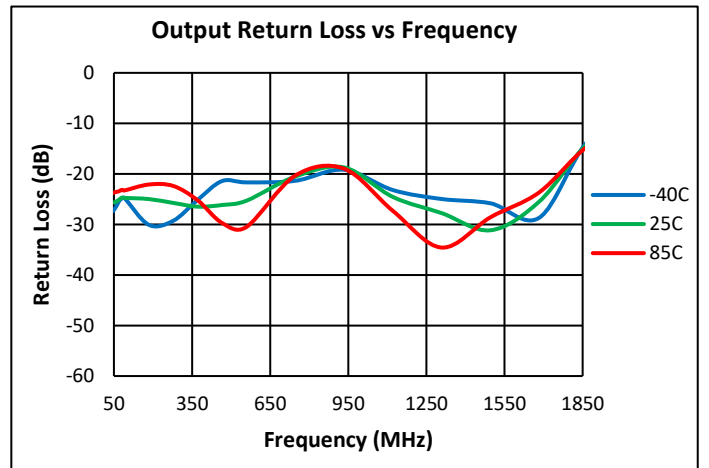
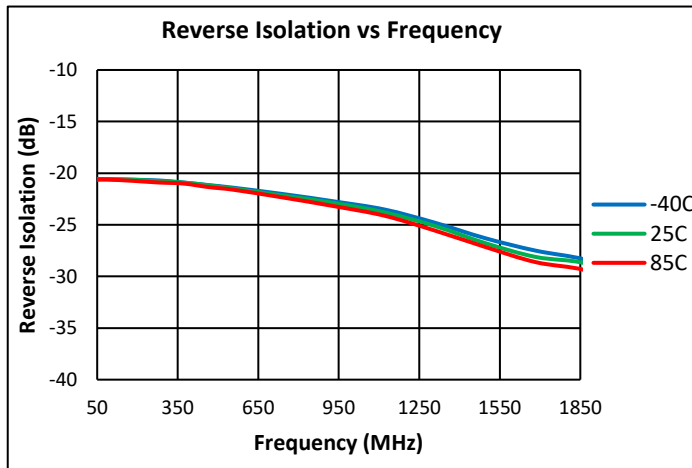
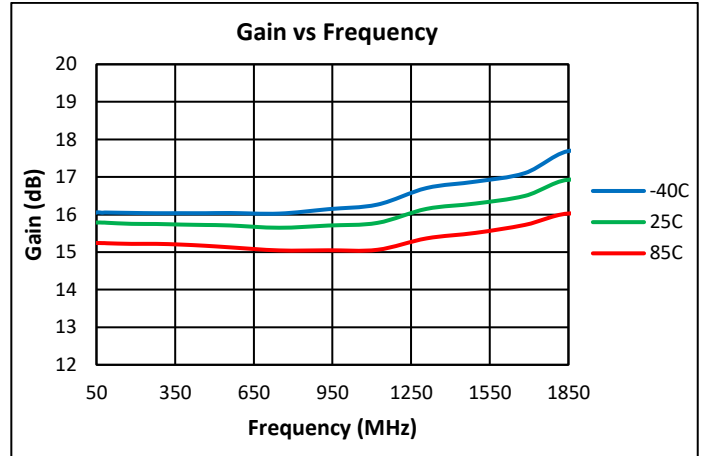
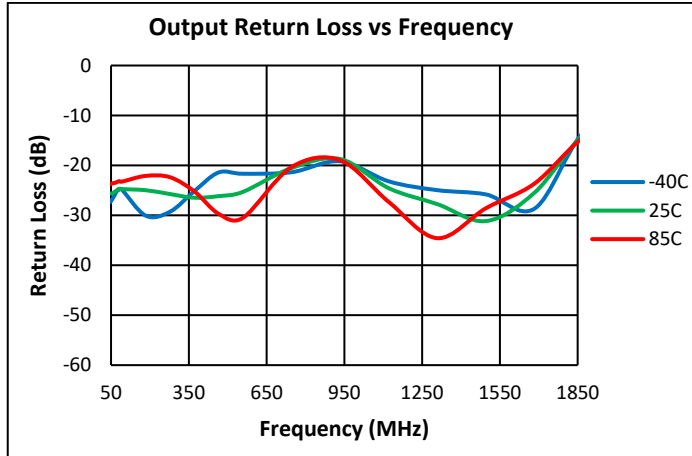

Performance Data (Cont'd)

Test conditions unless otherwise noted: V_{dd} = +7V, Temp = +25C, Z_o = 75Ω

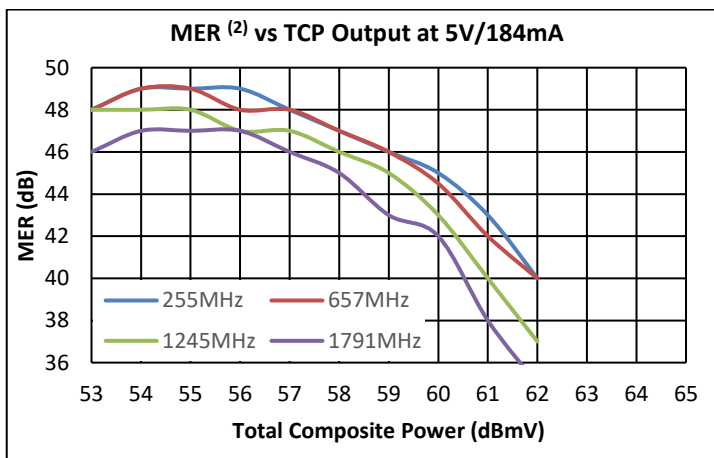
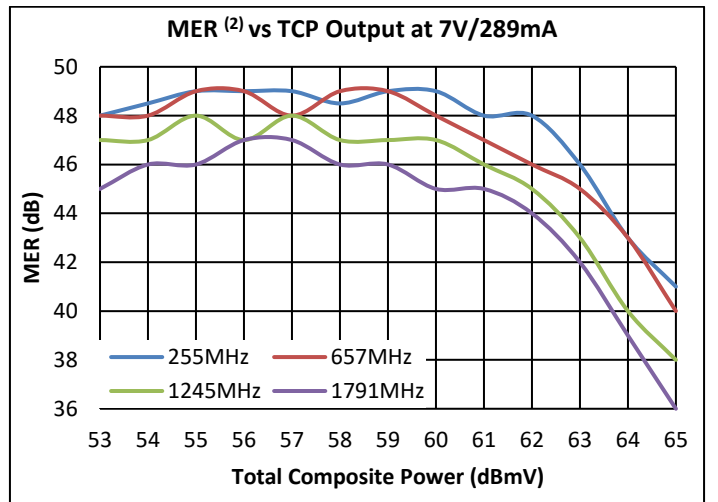
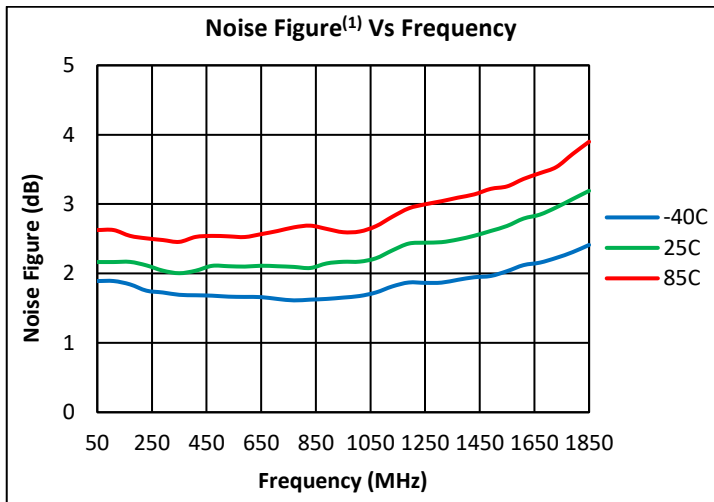
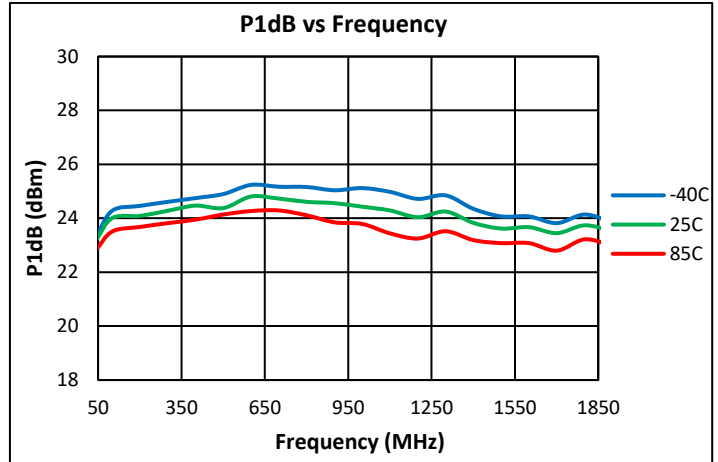
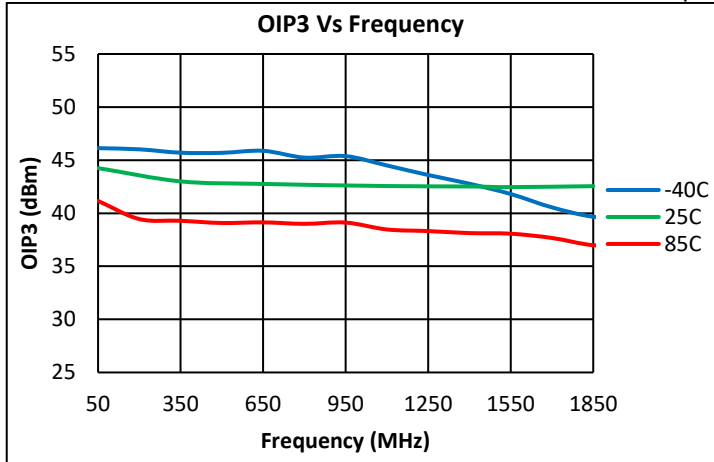

(1) Noise Figure of the part only. The input BALUN loss has been compensated.

(2) Test Conditions: 111MHz to 1791MHz, 0dB tilt, 149 channels. + 4 OFDM channels.

(1) Noise Figure of the part only. The input BALUN loss has been compensated.

(2) Test Conditions: 111MHz to 1791MHz, 0dB tilt, 149 channels. + 4 OFDM channels.

Performance Data Vs. Supply Voltage

Test conditions unless otherwise noted: Vdd = +7V, Temp = +25C, Zo = 75Ω

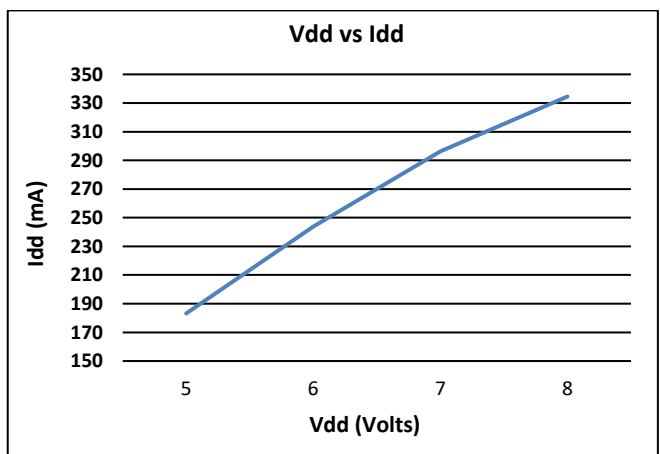
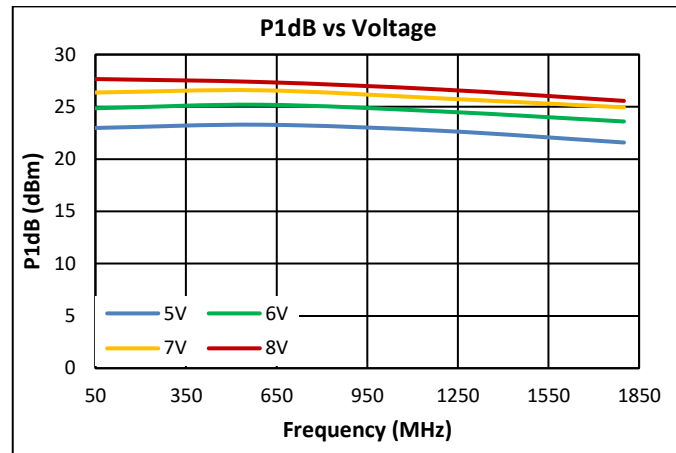
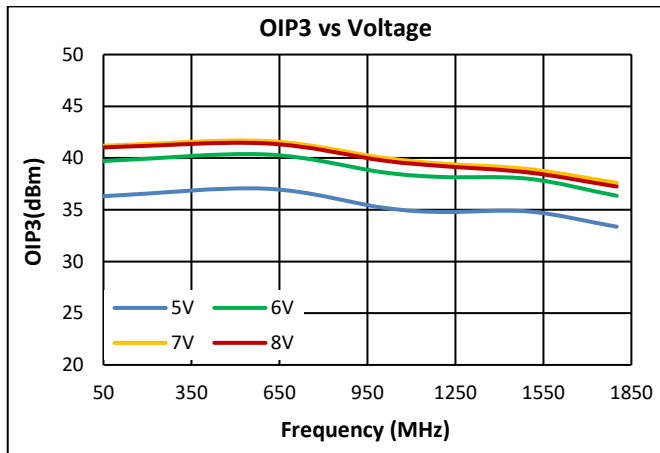
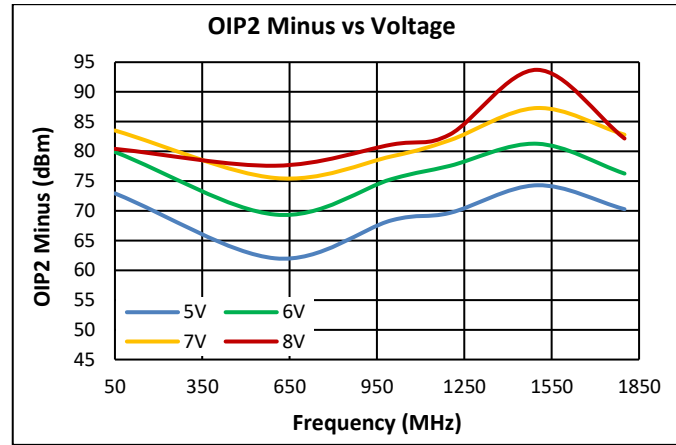
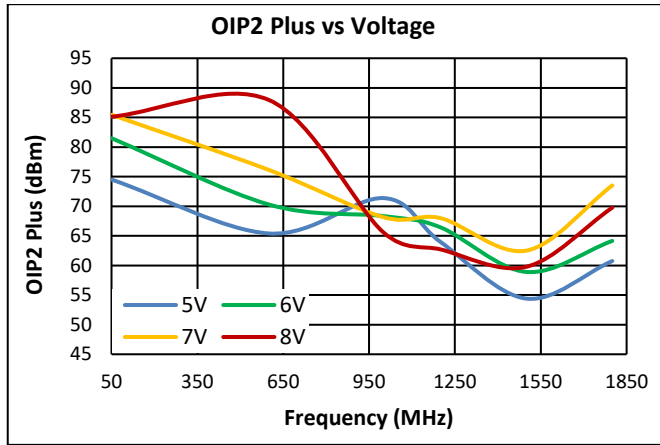

Package Marking

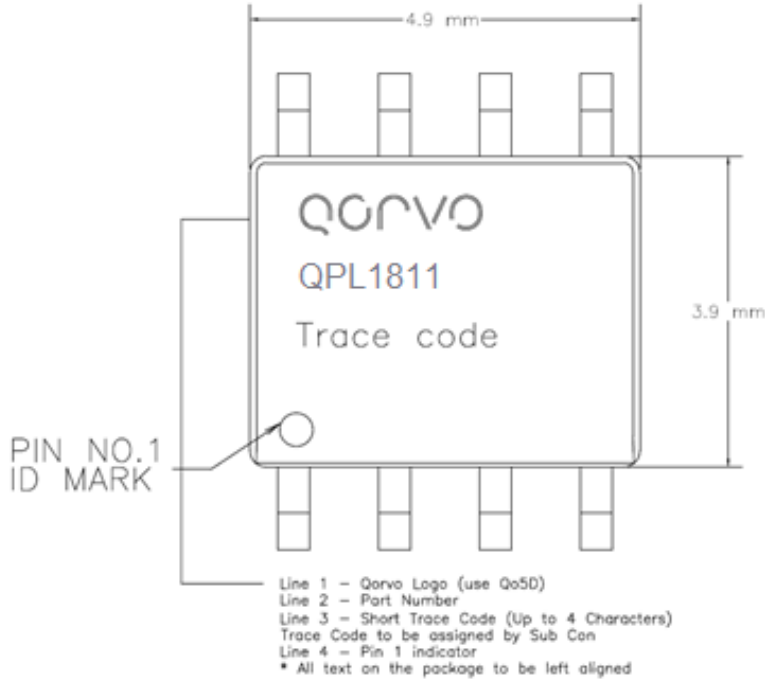

Pin Configuration and Description

Pin	Name	Description
1	RFIN1	RF input for plus side of amplifier.
2	NC	No Connect pin used for internal testing only. Do not connect to GND.
3	GND	Internally not connected. Recommended to connect to GND.
4	RFIN2	RF input for minus side of amplifier.
5	RFOUT2	RF output for minus side of amplifier.
6	GND	Internally not connected. Recommended to connect to GND.
7	GND	Internally not connected. Recommended to connect to GND.
8	RFOUT1	RF output for plus side of amplifier.
9	GND	Exposed bottom of part, device ground.

- Ensure that the backside via region makes good physical contact with the heat sink.

Package Outline

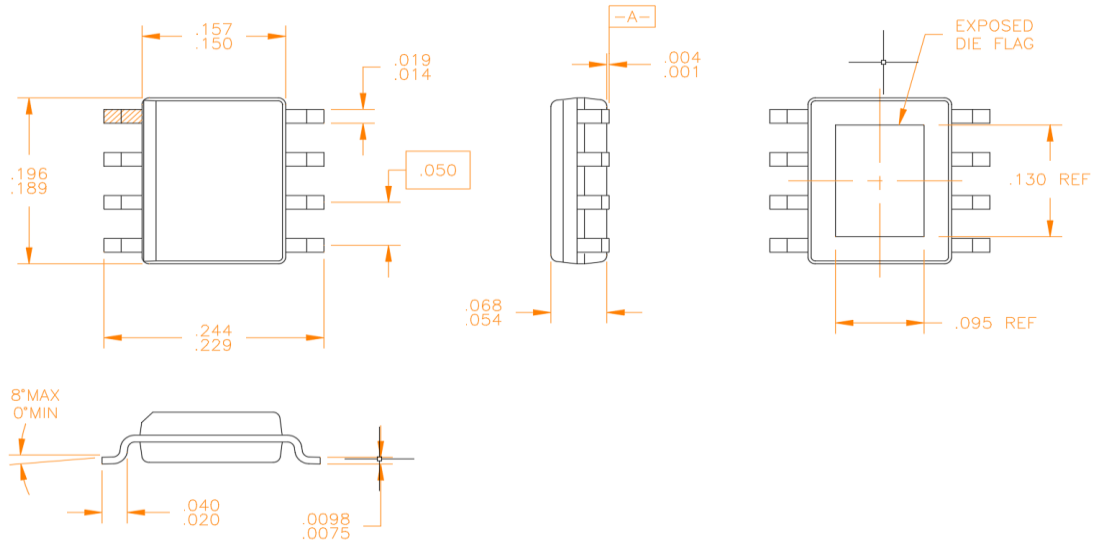

- Notes:
1. All Dimensions are in inches.
 2. Angles are in degrees.

Recommended Mounting Pattern

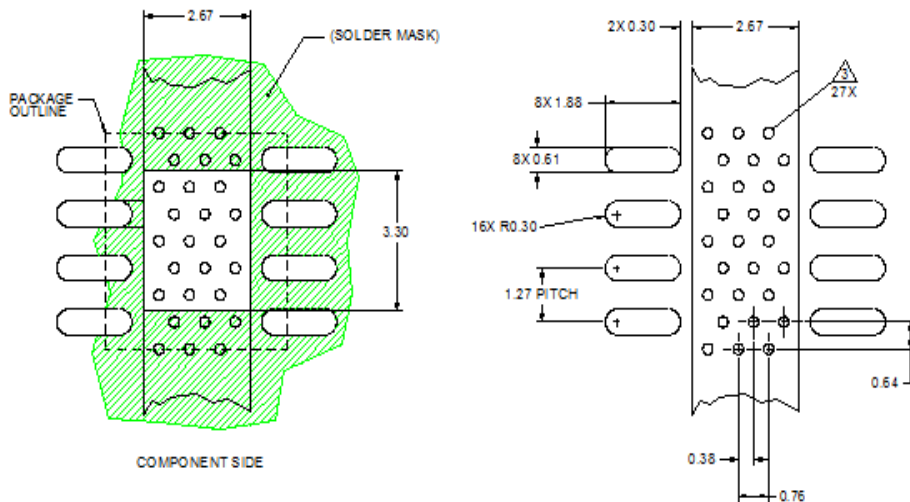

- Notes: All dimensions are in millimeters. Angles are in degrees.
1. Use 1 oz. copper minimum for top and bottom layer metal.
 2. Vias are required under the backside paddle for proper RF/DC grounding and thermal dissipation.
 3. Recommend a 0.35 mm diameter bit for drilling via holes and a final plated thru diameter of 0.25 mm.

Handling Precautions

Parameter	Rating	Standard
ESD – Human Body Model (HBM)	1A	ANSI / ESDA / JEDEC JS-001
ESD – Charged Device Model (CDM)	C4	ANSI / ESDA / JEDEC JS-002
MSL – Moisture Sensitivity Level	MSL2	IPC / JEDEC J-STD-020



Caution!
ESD-Sensitive Device

Solderability

Compatible with both lead-free (260°C max. reflow temp.) and tin/lead (245°C max. reflow temp.) soldering processes. Solder profiles available upon request.

Contact plating: Matte Sn

RoHS Compliance

This part is compliant with 2011/65/EU RoHS directive (Restrictions on the Use of Certain Hazardous Substances in Electrical and Electronic Equipment) as amended by Directive 2015/863/EU.

This product also has the following attributes:

- Lead Free
- Halogen Free (Chlorine, Bromine)
- Antimony Free
- TBBP-A (C₁₅H₁₂Br₄O₂) Free
- SVHC Free



Contact Information

For the latest specifications, additional product information, worldwide sales and distribution locations:

Tel: 1-844-890-8163

Web: www.qorvo.com

Email: customer.support@qorvo.com



Important Notice

The information contained herein is believed to be reliable; however, Qorvo makes no warranties regarding the information contained herein and assumes no responsibility or liability whatsoever for the use of the information contained herein. All information contained herein is subject to change without notice. Customers should obtain and verify the latest relevant information before placing orders for Qorvo products. The information contained herein or any use of such information does not grant, explicitly or implicitly, to any party any patent rights, licenses, or any other intellectual property rights, whether with regard to such information itself or anything described by such information. **THIS INFORMATION DOES NOT CONSTITUTE A WARRANTY WITH RESPECT TO THE PRODUCTS DESCRIBED HEREIN, AND QORVO HEREBY DISCLAIMS ANY AND ALL WARRANTIES WITH RESPECT TO SUCH PRODUCTS WHETHER EXPRESS OR IMPLIED BY LAW, COURSE OF DEALING, COURSE OF PERFORMANCE, USAGE OF TRADE OR OTHERWISE, INCLUDING THE IMPLIED WARRANTIES OF MERCHANTABILITY AND FITNESS FOR A PARTICULAR PURPOSE.**

Without limiting the generality of the foregoing, Qorvo products are not warranted or authorized for use as critical components in medical, life-saving, or life-sustaining applications, or other applications where a failure would reasonably be expected to cause severe personal injury or death. Copyright 2024 © Qorvo, Inc. | Qorvo is a registered trademark of Qorvo, Inc.

Looking for pricing, stock, or lifecycle information?

Click below to explore more details on WIN SOURCE:

-  [View QPL1811SR on WIN SOURCE](#)
-  [Qorvo US Inc. Information](#)

Optimize Your Supply Chain with WIN SOURCE Solutions

-  Global Sourcing Solution
-  Obsolete Management
-  Cost Control Management
-  Shortage Management
-  Alternative Solution
-  Excess Inventory Management