

Product Overview

The QPA9442 is a wideband, high linearity driver amplifier. With optimized tuning, this device can provide up to 19dB of gain and achieve an output P1dB of 1W. The amplifier can provide excellent linearity performance with +46dBm output 3rd order intercept (OIP3), making it perfectly suited for 5G base station applications.

The QPA9442 is tunable over all cellular bands in the entire operating frequency band of 0.6 – 5.0 GHz and incorporates a shut-down function through the V_{PD} pin.

The QPA9442 is housed in a 20-pin 4X4mm SMT package.

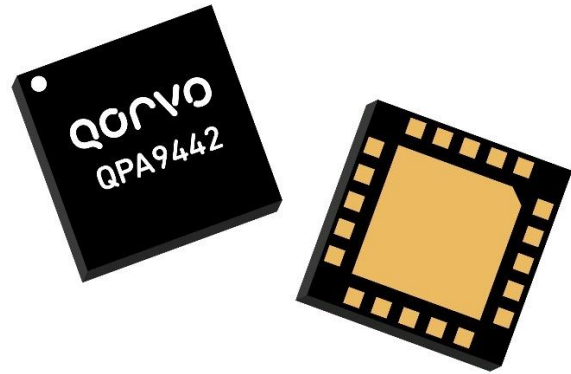

20 Pad 4 x 4 mm Laminate Package

Key Features

- 0.6 – 5.0 GHz Operational Frequency
- +30 dBm P1dB
- 19 dB achievable Gain at Band 1
- +45.0 dBm OIP3
- +5 V Single Supply
- DC Power Shutdown Feature
- Internal RF Overdrive Protection
- Internal DC Overvoltage Protection

Functional Block Diagram

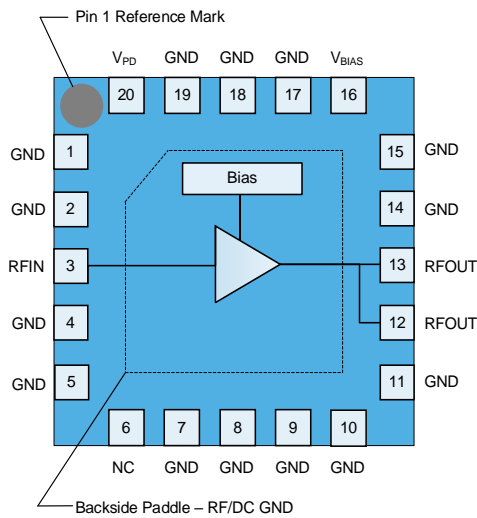

Top View

Applications

- 5G m-MIMO
- Mobile Infrastructure
- General Purpose Wireless
- TDD System

Ordering Information

Part No.	Description
QPA9442TR13	2500 pcs on 13" reel (standard)
QPA9442EVB-01	1.8-2.2GHz Tuned Evaluation Board
QPA9442EVB-02	2.5-2.7GHz Tuned Evaluation Board
QPA9442EVB-03	0.66-0.82GHz Tuned Evaluation Board

Absolute Maximum Ratings

Parameter	Rating
Storage Temperature	-65 to +150°C
RF Input Power, ON state, 1C 20MHz LTE, 8.5dB PAR, T=25 °C, 2:1 VSWR, In-band	+24 dBm
RF Input Power, OFF state, 1C 20MHz LTE, 8.5dB PAR, T=25 °C, 2:1 VSWR, In-band	+24 dBm
Device Voltage (V _{CC})	+6 V

Exceeding any one or a combination of the Absolute Maximum Rating conditions may cause permanent damage to the device. Extended application of Absolute Maximum Rating conditions to the device may reduce device reliability.

Recommended Operating Conditions

Parameter	Min	Typ	Max	Units
Supply Voltage (V _{CC})	+4.75	+5	+5.25	V
T _{CASE}	-40		+115	°C
T _j for >10 ⁶ hours MTTF			+218	°C

Electrical specifications are measured at specified test conditions. Specifications are not guaranteed over all recommended operating conditions. Operating the part above the maximum recommended T_{case} may degrade performance.

Electrical Specifications – 1.8 - 2.2 GHz Reference Design

Parameter	Conditions ⁽¹⁾	Min	Typ	Max	Units
Operational Frequency Range		1800		2200	MHz
Gain	At 1840MHz	14.2	15.5		dB
	At 2140MHz	14.0	15.3		dB
	At 1840MHz at +115°C	13.2			dB
	At 2140MHz at +115°C	13.0			dB
Gain Flatness ⁽²⁾	F _c ± 100MHz		±0.25		dB
Input Return Loss			12		dB
Output Return Loss			15		dB
Output P1dB	At 1840MHz	28.7	29.4		dBm
	At 2140MHz	28.7	29.9		dBm
	At 1840MHz at +115°C	28			dBm
	At 2140MHz at +115°C	28			dBm
Output IP3	P _{out} =+15dBm/tone, Δf=1MHz, at 1840MHz		41.5		dBm
	P _{out} =+15dBm/tone, Δf=1MHz, at 2140MHz		45.0		dBm
ACPR	20MHz LTE TM1.1, PAR 8.5dB, P _{out} = +17dBm		-50		dBc
Noise Figure ⁽³⁾	Over frequency and process		5.7		dB
	Over frequency and process at -40°C			5.5	dB
	Over frequency and process at +115°C			7.8	dB
Power dissipation	P _{out} = +10dBm, CW		1.15	1.4	W
Device Current, OFF	V _{PD} = 0 V			2	mA
V _{PD} , Logic Low		0		0.63	V
V _{PD} , Logic High		1.17		V _{CC}	V
Device ON or OFF Timing			0.26	1	μS
Thermal Resistance, θ _{jc}	Junction to case		31		°C/W

Notes:

1. Test conditions unless otherwise noted: V_{CC} = V_{BIAS} = +5.0V, V_{PD} = +1.8V, I_{CQ} = 235 mA, Temp = +25 °C, matched reference circuit.
2. Gain flatness is dependent on external matching circuit.
3. Minimum or maximum specification listed is guaranteed by design. Not tested in production.

Evaluation Board, 1800 – 2200 MHz Reference Design

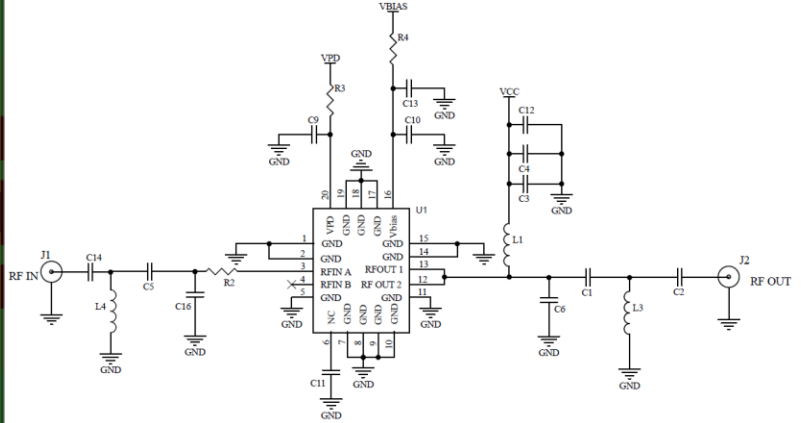
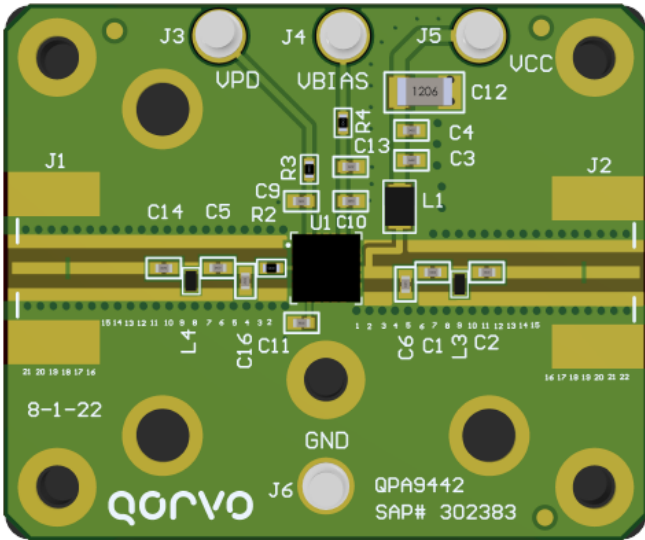

Notes:

- Components shown on the PCB layout but not on the schematic are not used.

Bill of Material, 1800 – 2200 MHz

Reference Des.	Value	Description	Manuf.	Part Number
n/a	n/a	Printed Circuit Board	Qorvo	
U1	n/a	1 W High Linearity Amplifier	Qorvo	QPA9442
C5, C16	1.3 pF	CAP, 0402, ±0.1pF, 50V, HI-Q	Various	
C1	2 pF	CAP, 0402, ±0.1pF, 50V, HI-Q	Various	
C6	3 pF	CAP, 0402, ±0.1pF, 50V, HI-Q	Various	
C2, C14	22 pF	CAP, 0402, 5%, 50V, HI-Q	Various	
C3, C9, C10	220 pF	CAP, 0402, 5%, 50V, C0G	Various	
C4, C13	1 µF	CAP, 0402, 10%, 10V, X7S	Various	
C12	10 µF	CAP, 1206, 10%, 25V, X7R	Various	
L3	5.6 nH	IND, 0402, ±0.1nH, W/W	Murata	LQW15AN5N6B80D
L4	12 nH	IND, 0402, 2%, W/W	Murata	LQW15AN12NG00D
L1	5.6 nH	IND, 0805, 5%, W/W	Coilcraft	0805CS-050XJLB
R2	3.9 Ω	RES, 0402, 5%, 1/16W	Various	
R3, R4	0 Ω	RES, 0402, 1/10W	Various	
C11	DNP	n/a	n/a	

Logic Table

Parameter, V _{PD}	High	Low
Device State	ON	OFF
Voltage	>1.17V	<0.63V

Typical Performance, 1800 – 2200 MHz Reference Design

Parameter	Conditions	Typical Value			Units
Frequency		1800	2000	2200	MHz
Gain		14.9	15.4	14.8	dB
Input Return Loss		7.7	13.9	11.3	dB
Output Return Loss		8.6	9.7	11.2	dB
Output P1dB		30.6	30.3	30.2	dB
Output P3dB		33.0	32.1	31.1	dBm
Output IP3	P _{out} = +15dBm/tone, Δf = 1MHz	41.4	45.1	42.4	dBm
ACPR	P _{out} =+17 dBm, 1C LTE, 20MHz, 8.5dB PAR	-54.0	-52.3	-50.7	dBc
Noise Figure		5.8	5.6	6.1	dB
Device Current	V _{CC} and V _{BIAS} combined	240			mA

Notes:

1. Test Conditions unless otherwise noted: V_{CC} = V_{BIAS} = +5.0 V, V_{PD} = +1.8 V, I_{CO} = 235 mA, Temp = +25 °C, 50 Ω system.

Performance Plots – 1800-2200 MHz Reference Design

Test conditions unless otherwise noted: $V_{CC} = V_{BIAS} = +5.0V$, $V_{PD} = +1.8V$, $I_{CQ} = 235\text{ mA}$, Temp = +25 °C, 50 Ω system.

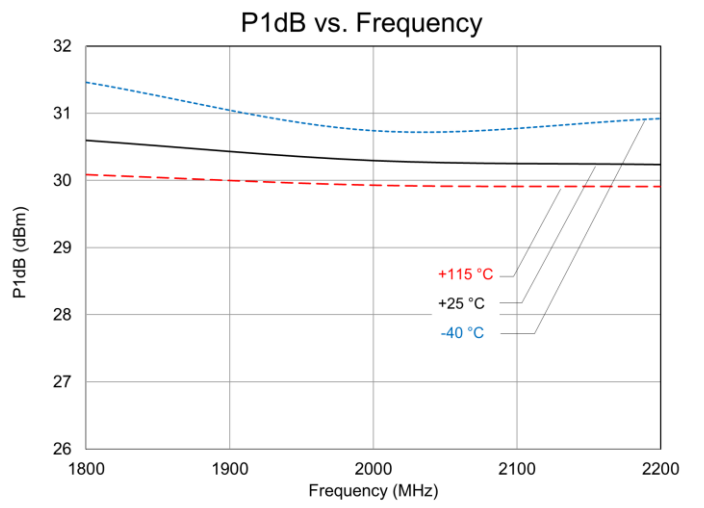
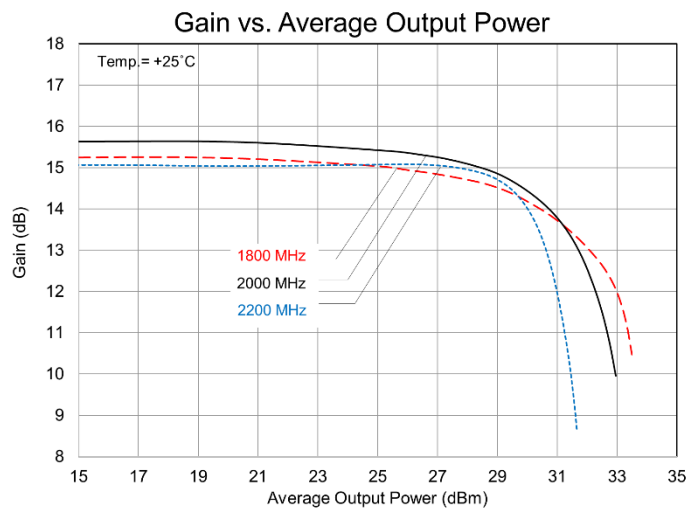
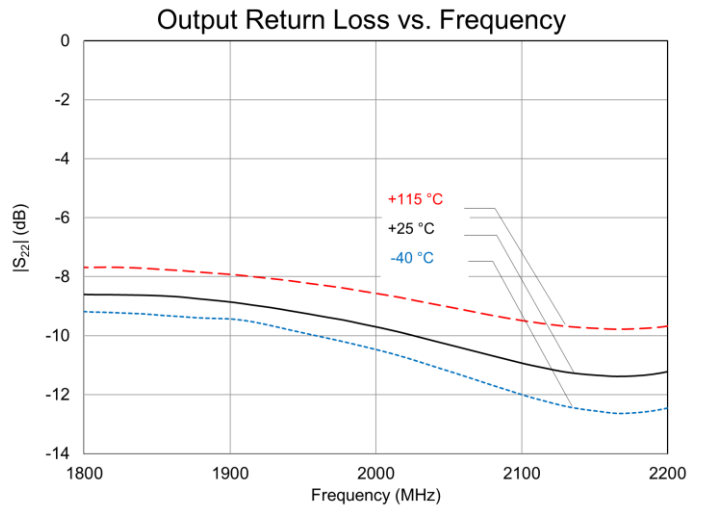
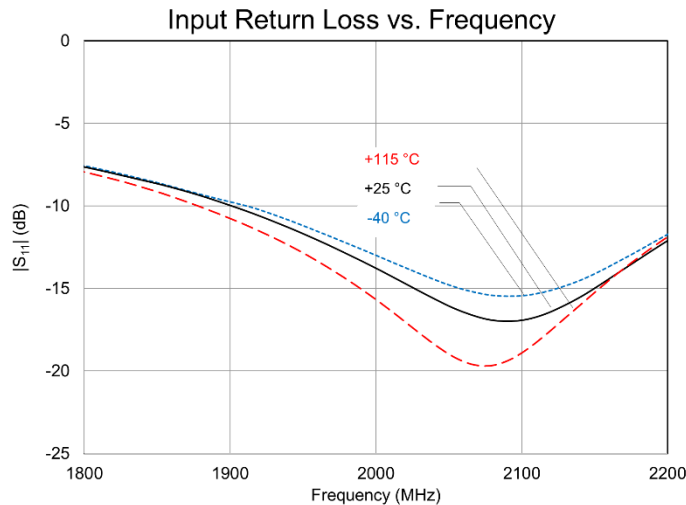
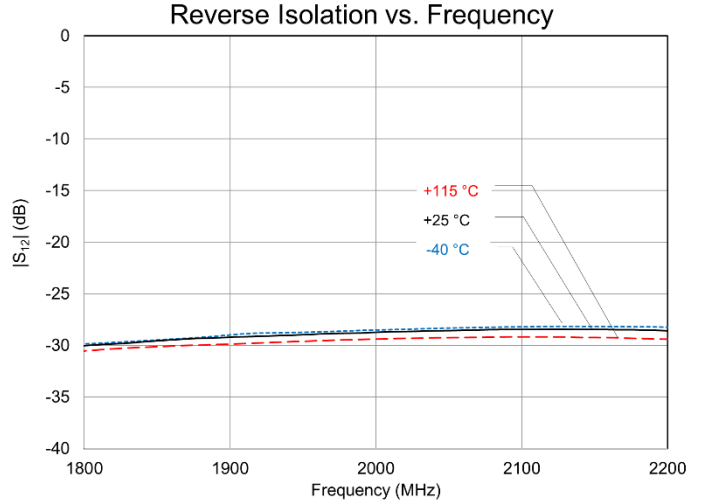
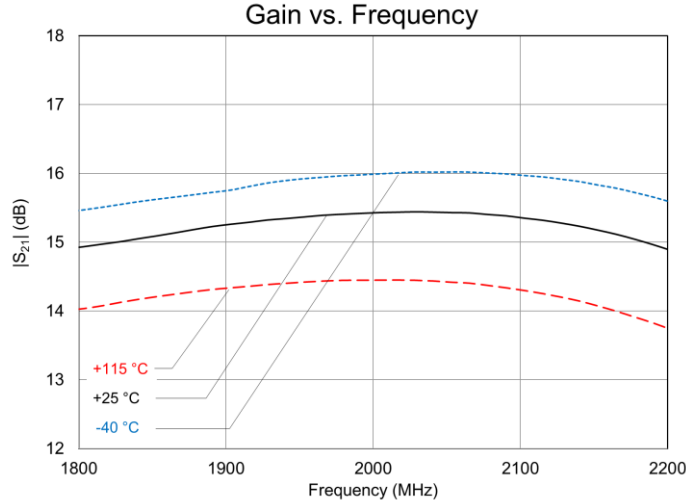

Performance Plots – 1800-2200 MHz Reference Design – Continued

Test conditions unless otherwise noted: $V_{CC} = V_{BIAS} = +5.0V$, $V_{PD} = +1.8V$, $I_{CQ} = 235\text{ mA}$, Temp = +25 °C, 50 Ω system.

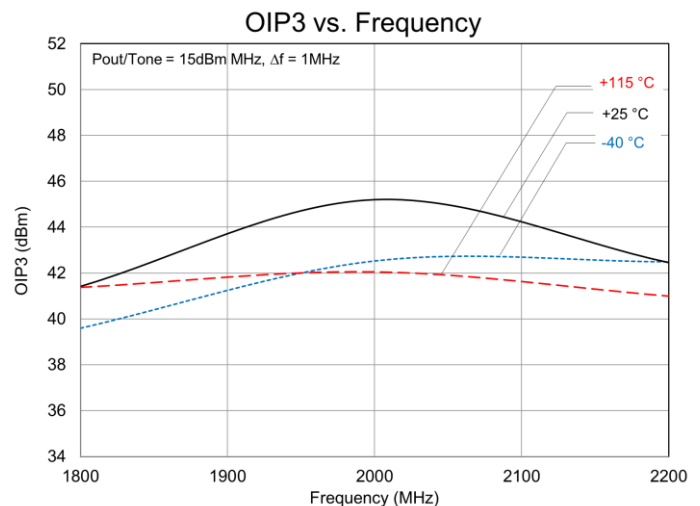
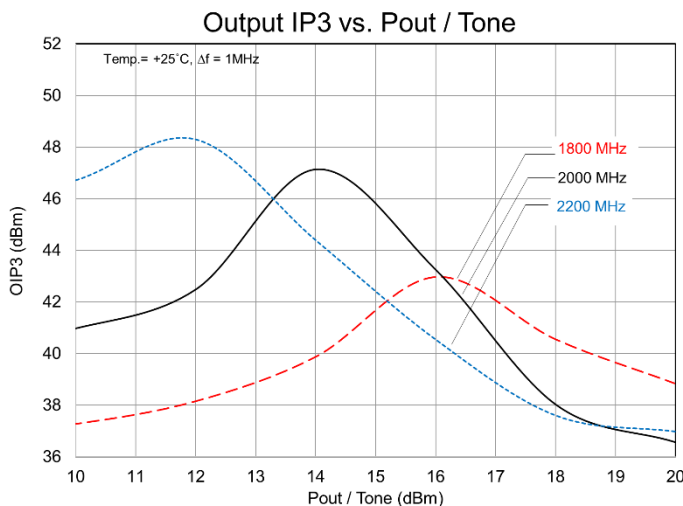
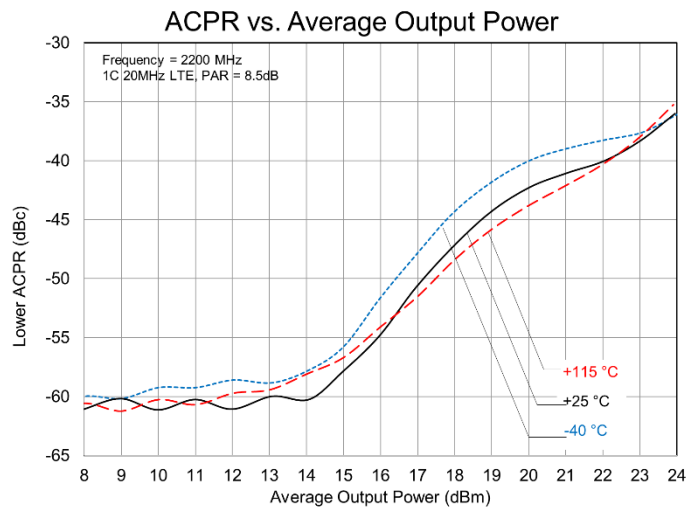
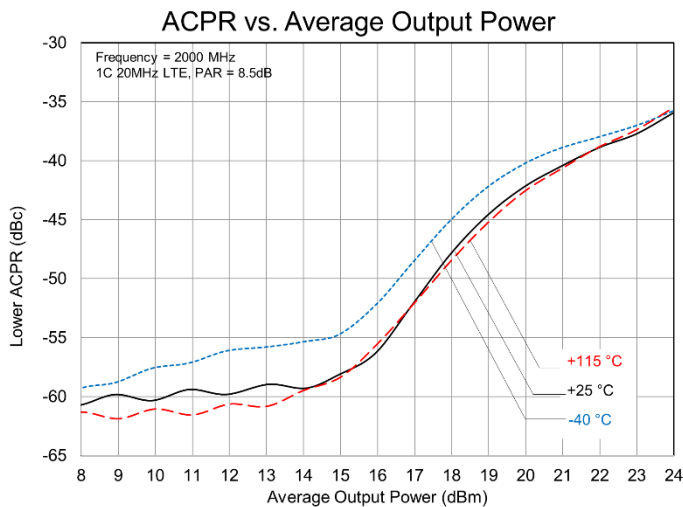
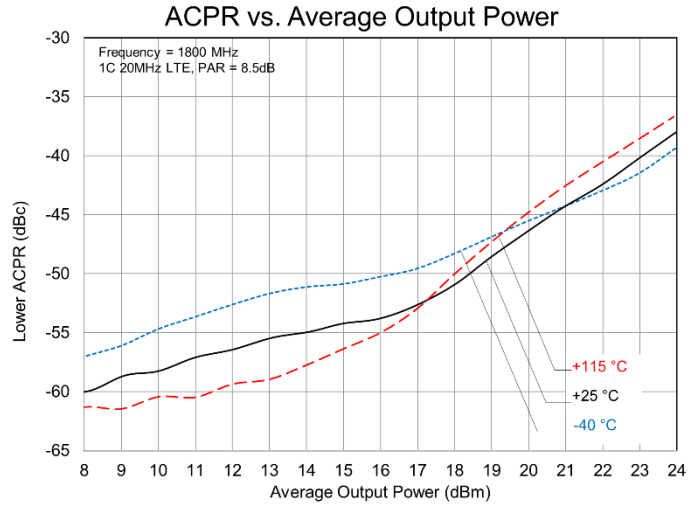
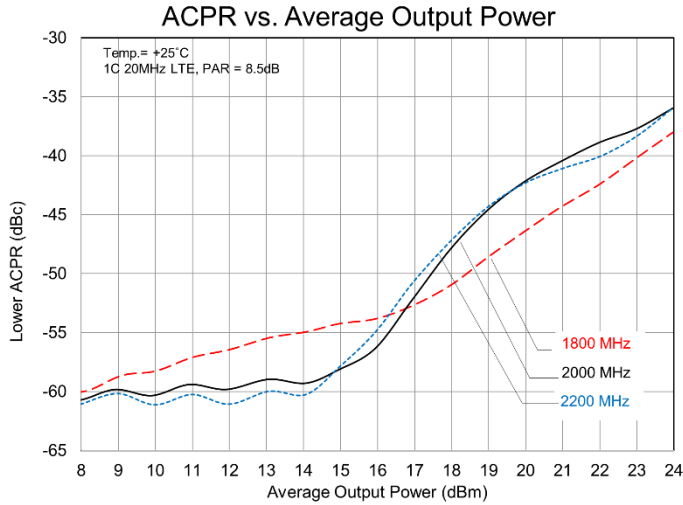

Evaluation Board, 2500 – 2700 MHz Reference Design

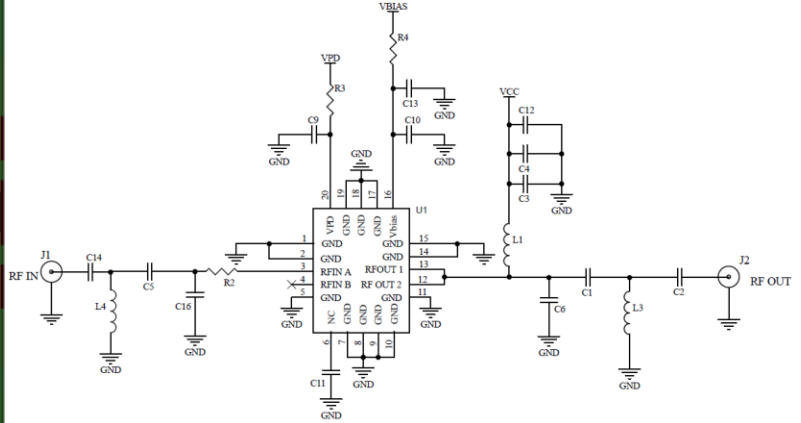
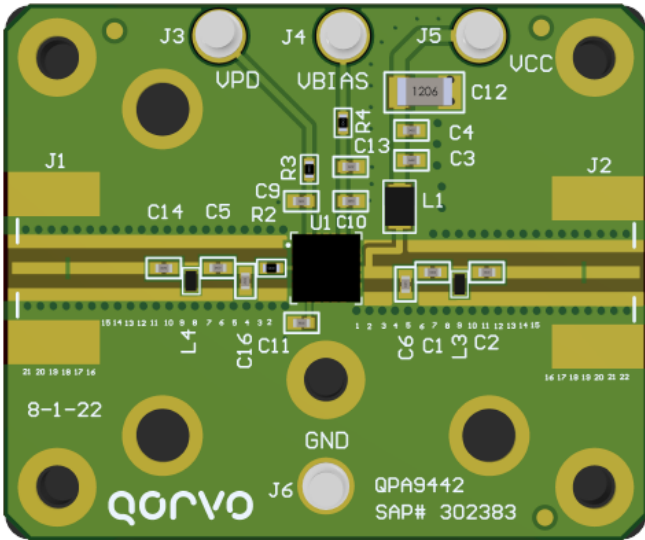

Notes:

- 1. Components shown on the PCB layout but not on the schematic are not used.

Bill of Material, 2500 – 2700 MHz

Reference Des.	Value	Description	Manuf.	Part Number
n/a	n/a	Printed Circuit Board	Qorvo	
U1	n/a	1 W High Linearity Amplifier	Qorvo	QPA9442
C5	0.8 pF	CAP, 0402, ±0.05pF, 50V, HI-Q,	Various	
C6	1.5 pF	CAP, 0402, ±0.1pF, 50V, HI-Q	Various	
C2	22 pF	CAP, 0402, 5%, 50V, HI-Q	Various	
C3, C9, C10	220 pF	CAP, 0402, 5%, 50V, C0G	Various	
C4, C13	1 µF	CAP, 0402, 10%, 10V, X7S	Various	
C12	10 µF	CAP, 1206, 10%, 25V, X7R	Various	
C16	0.5 pF	CAP, 0402, ±0.05pF, 50V, HI-Q,	Various	
L3, L4	0.4 pF	CAP, 0402, ±0.1pF, 50V, HI-Q	Various	
L1	5.6 nH	IND, 0805, 5%, W/W	Coilcraft	0805CS-050XJLB
R2	2.2 Ω	RES, 0402, 5%, 1/16W	Various	
R3, R4, C1, C14	0 Ω	RES, 0402, 1/10W	Various	
C11	DNP	n/a	n/a	

Logic Table

Parameter, V _{PD}	High	Low
Device State	ON	OFF

Typical Performance, 2500 – 2700 MHz Reference Design

Parameter	Conditions	Typical Value			Units
		2500	2600	2700	
Frequency		2500	2600	2700	MHz
Gain		15.7	16.2	16.0	dB
Input Return Loss		9.8	15.9	12.2	dB
Output Return Loss		11.3	13.1	16.8	dB
Output P1dB		30.1	29.8	29.8	dB
Output P3dB		31.7	31.1	30.7	dBm
Output IP3	P _{out} = +10dBm/tone, Δf = 1MHz	45.6	44.7	44.9	dBm
ACPR	P _{out} =+17 dBm, 1C LTE, 20MHz, 8.5dB PAR	-57.2	-57.7	-58.6	dBc
Noise Figure		4.6	4.5	4.6	dB
Device Current	V _{CC} and V _{BIAS} combined	235			mA

Notes:

1. Test Conditions unless otherwise noted: V_{CC} = V_{BIAS} = +5.0 V, V_{PD} = +1.8 V, I_{CC} = 235 mA, Temp = +25 °C, 50 Ω system.

Performance Plots – 2500-2700 MHz Reference Design

Test conditions unless otherwise noted: $V_{CC} = V_{BIAS} = +5.0V$, $V_{PD} = +1.8V$, $I_{CQ} = 235\text{ mA}$, $Temp = +25\text{ }^{\circ}\text{C}$, $50\text{ }\Omega$ system.

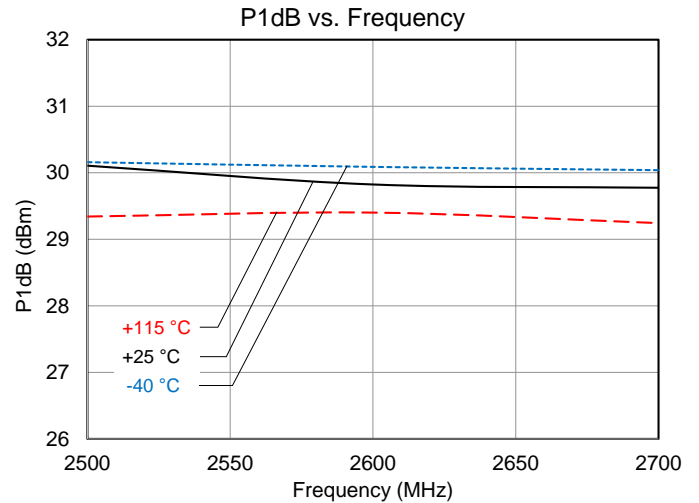
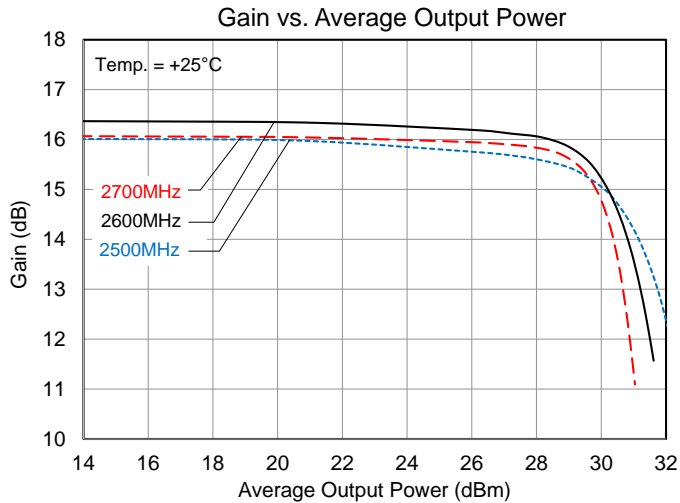
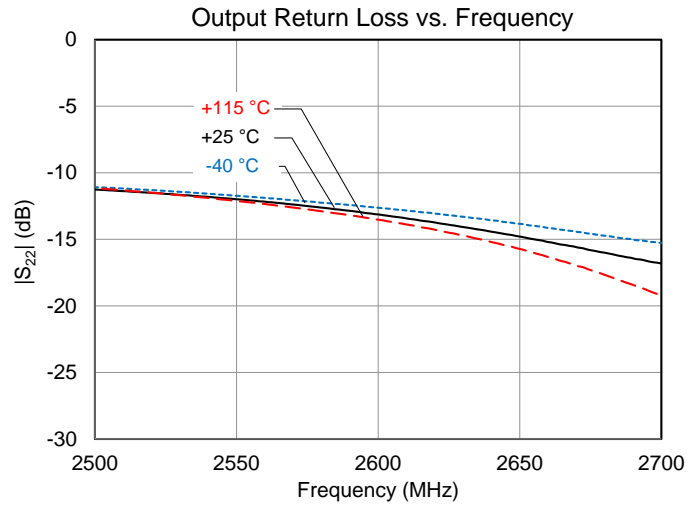
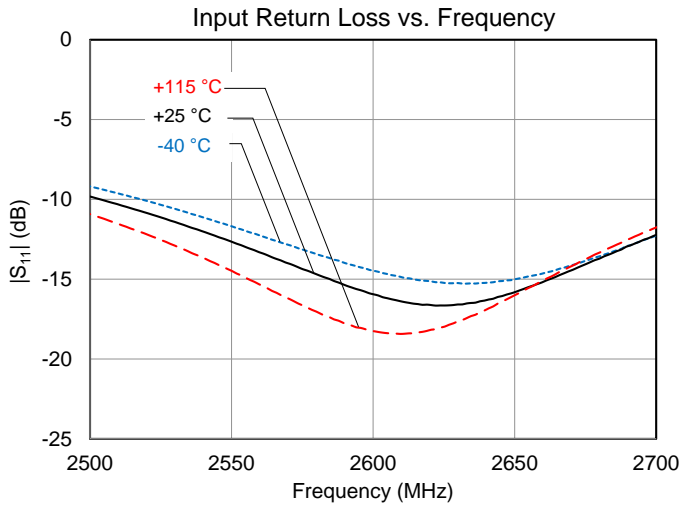
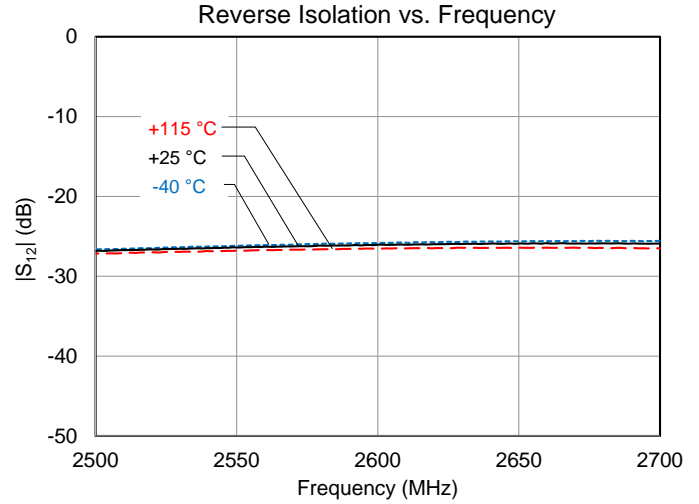
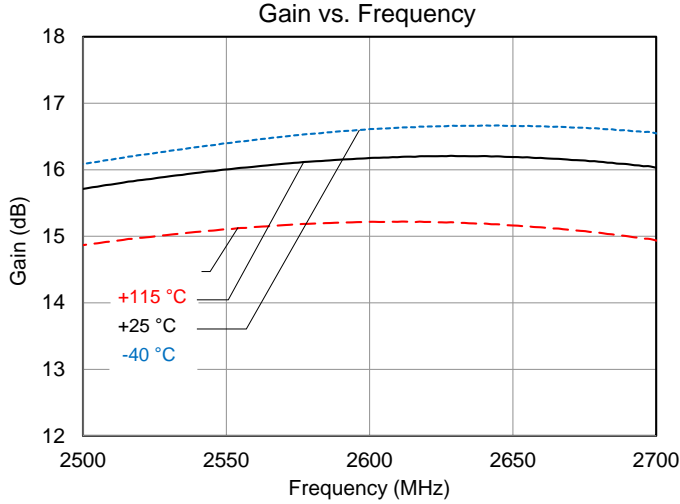

Performance Plots – 2500-2700 MHz Reference Design – Continued

Test conditions unless otherwise noted: $V_{CC} = V_{BIAS} = +5.0V$, $V_{PD} = +1.8V$, $I_{CQ} = 235\text{ mA}$, Temp = $+25\text{ }^{\circ}\text{C}$, $50\ \Omega$ system.

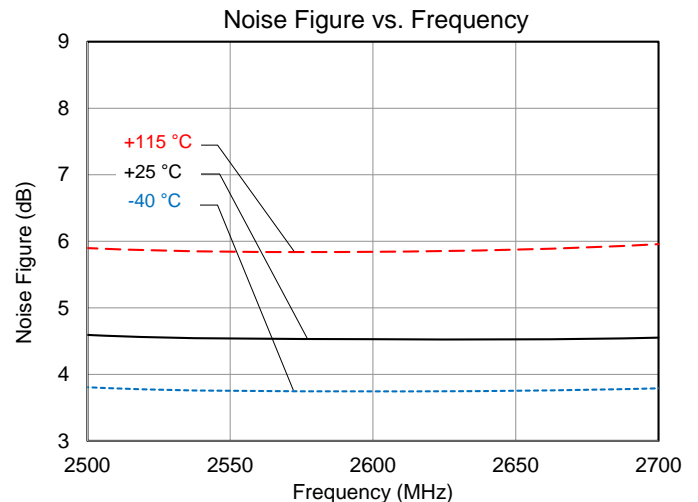
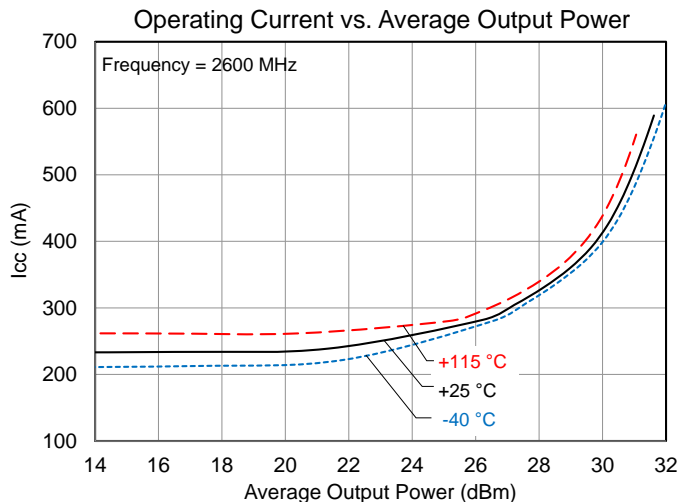
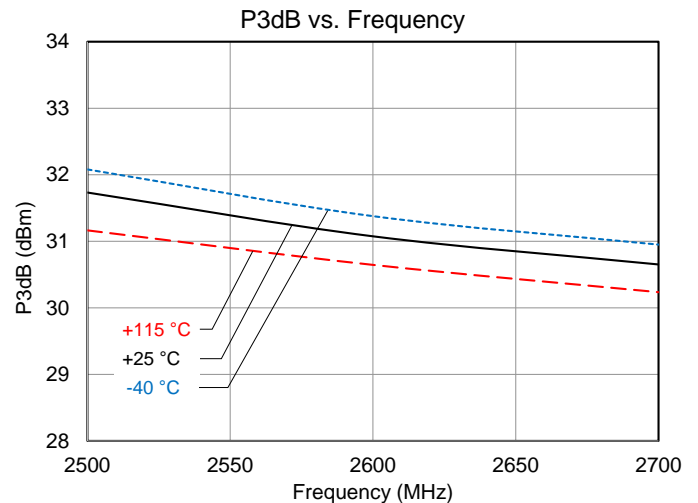
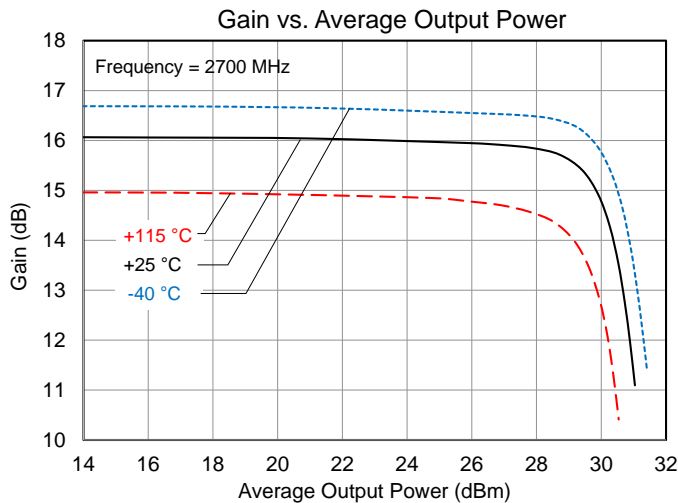
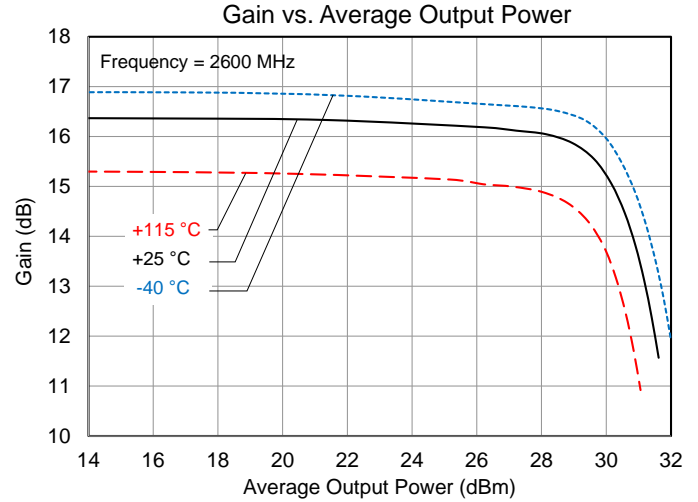
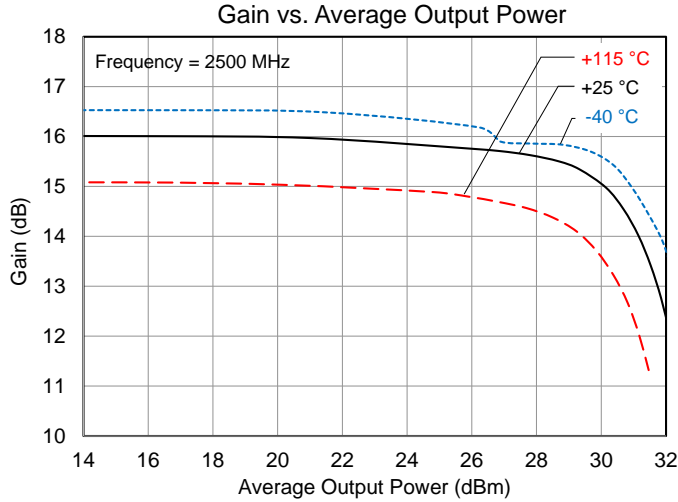

Performance Plots – 2500-2700 MHz Reference Design – Continued

Test conditions unless otherwise noted: $V_{CC} = V_{BIAS} = +5.0V$, $V_{PD} = +1.8V$, $I_{CQ} = 235\text{ mA}$, $Temp = +25\text{ }^{\circ}\text{C}$, $50\text{ }\Omega$ system.

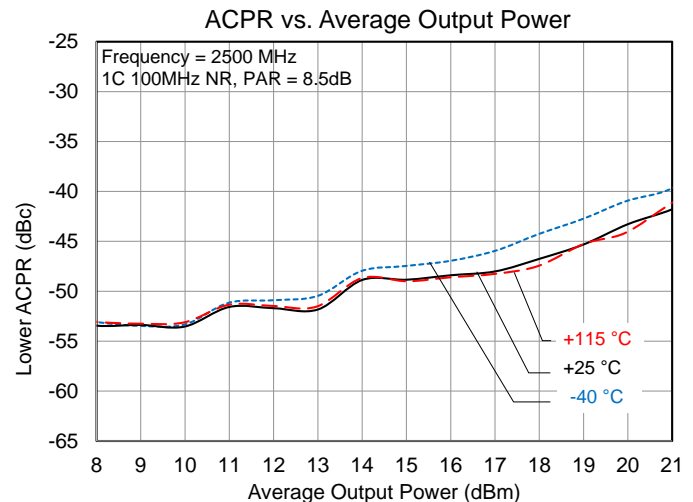
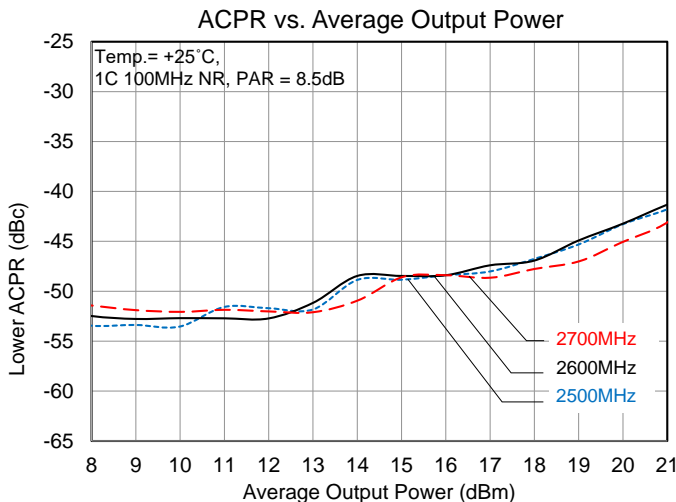
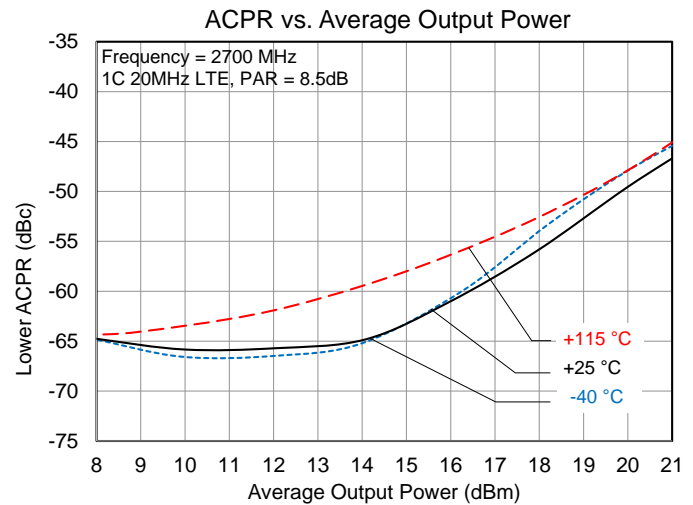
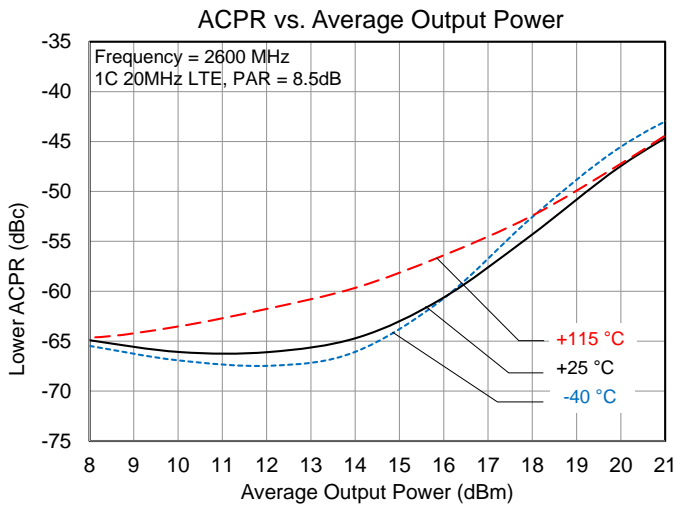
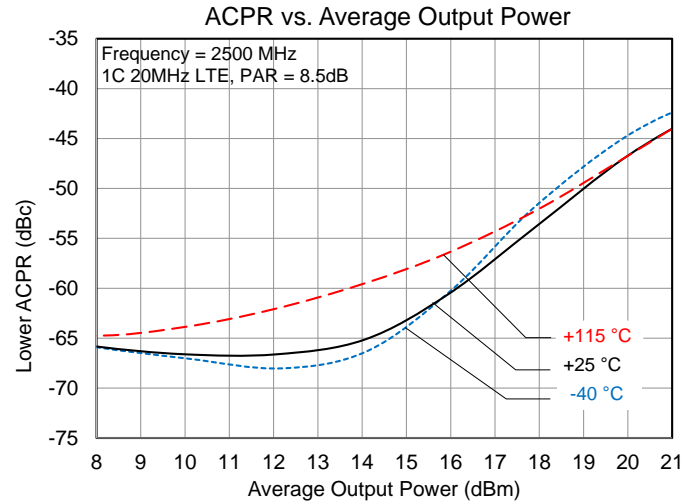
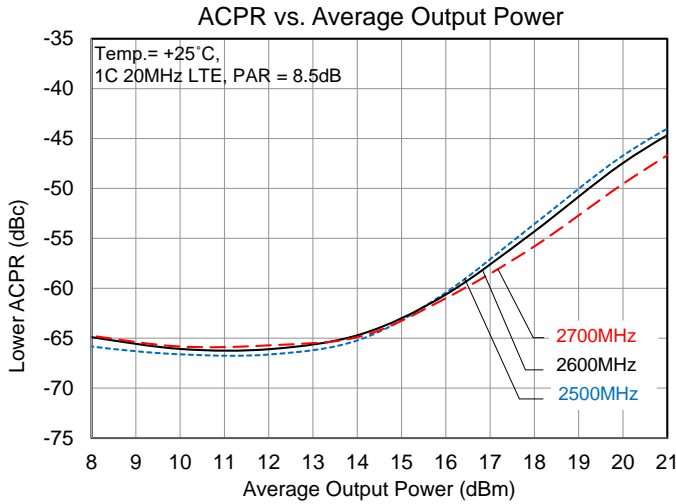

Performance Plots – 2500-2700 MHz Reference Design – Continued

Test conditions unless otherwise noted: $V_{CC} = V_{BIAS} = +5.0V$, $V_{PD} = +1.8V$, $I_{CQ} = 235\text{ mA}$, $Temp = +25\text{ }^{\circ}\text{C}$, $50\text{ }\Omega$ system.

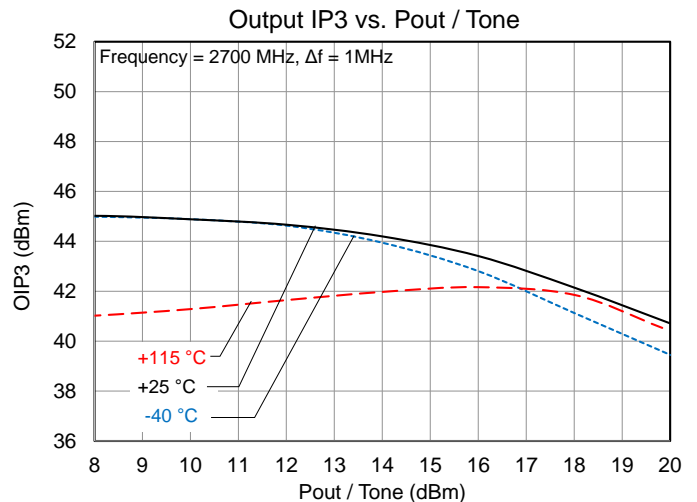
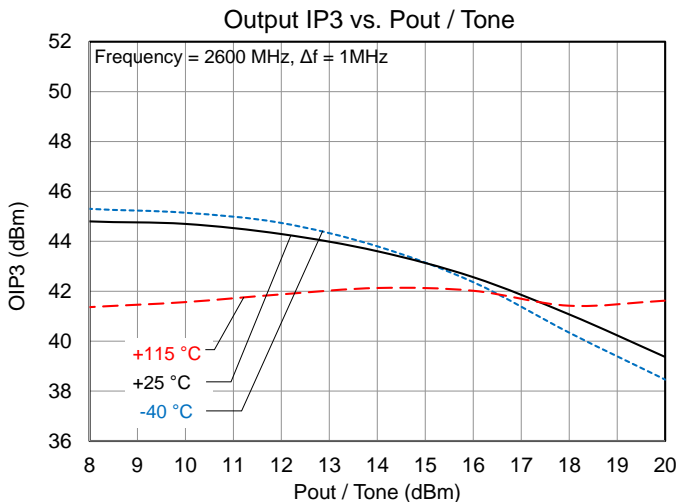
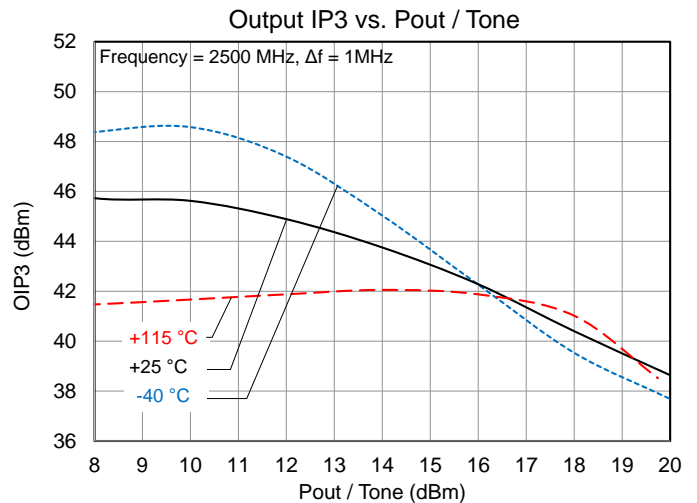
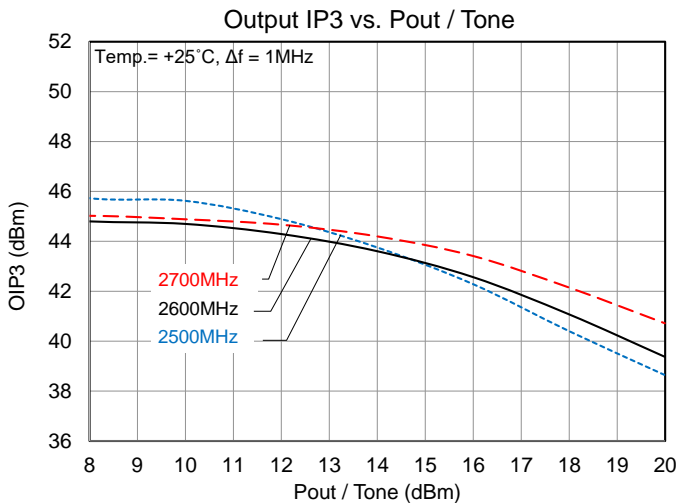
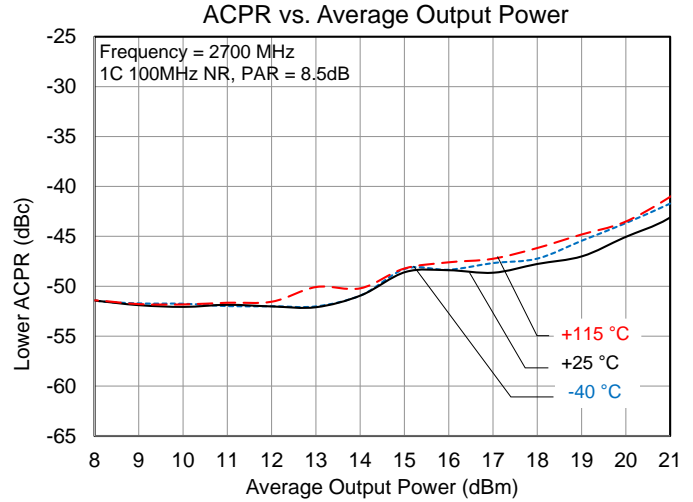
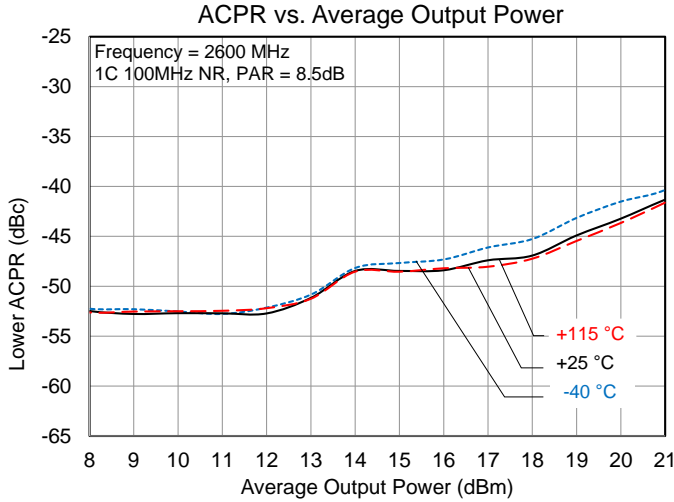

Evaluation Board, 660 – 820 MHz Reference Design

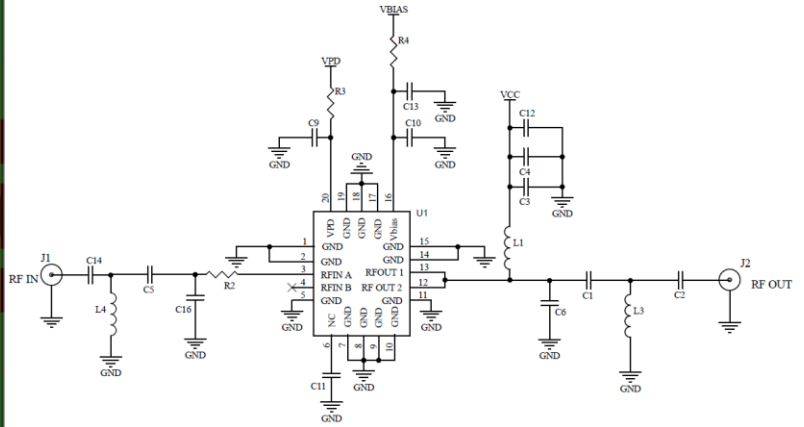
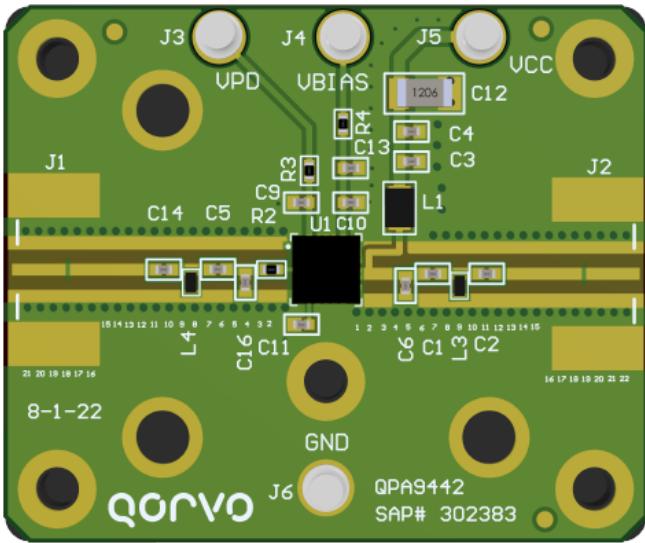

Notes:

- Components shown on the PCB layout but not on the schematic are not used.

Bill of Material, 660 – 820 MHz

Reference Des.	Value	Description	Manuf.	Part Number
n/a	n/a	Printed Circuit Board	Qorvo	
U1	n/a	1 W High Linearity Amplifier	Qorvo	QPA9442
C5	1.3 nH	IND, 0402, +/-0.1nH, 3150mA, W/W	Various	
C6, C16	DNP	n/a	n/a	
C2, C14	22 pF	CAP, 0402, 5%, 50V, HI-Q	Various	
C3, C9, C10	220 pF	CAP, 0402, 5%, 50V, COG	Various	
C4, C13	1 μF	CAP, 0402, 10%, 10V, X7S	Various	
C12	10 μF	CAP, 1206, 10%, 25V, X7R	Various	
L4	10 pF	CAP, 0402, 1%, 50V, HI-Q	Various	
L3	5.6 pF	CAP, 0402, ±0.05pF, 200V, COG,HI-Q		
L1	18 nH	IND, 0805, 5%, W/W	Coilcraft	0805CS-050XJLB
R2	2.2 Ω	RES, 0402, 5%, 1/10W	Various	
R3, R4	0 Ω	RES, 0402, 1/10W	Various	
C11	DNP	n/a	n/a	
C1	4.3 nH	IND, 0402, ±0.1nH, W/W		

Logic Table

Parameter, V _{PD}	High	Low
Device State	ON	OFF

Typical Performance, 660 – 820 MHz Reference Design

Parameter	Conditions	Typical Value			Units
Frequency		660	740	820	MHz
Gain		20.6	20.9	20.6	dB
Input Return Loss		10.2	17.9	14.0	dB
Output Return Loss		13.9	14.1	17.3	dB
Output P1dB		29.5	30.0	29.7	dB
Output P3dB		31.0	31.4	30.9	dBm
Output IP3	P _{out} = +10dBm/tone, Δf = 1MHz	37.9	37.4	37.0	dBm
ACPR	P _{out} =+18 dBm, 1C LTE, 20MHz, 8.5dB PAR	-51.0	-52.1	-51.3	dBc
Noise Figure		5.0	5.0	5.9	dB
Device Current	V _{CC} and V _{BIAS} combined	235			mA

Notes:

1. Test Conditions unless otherwise noted: V_{CC} = V_{BIAS} = +5.0 V, V_{PD} = +1.8 V, I_{CO} = 235 mA, Temp = +25 °C, 50 Ω system.

Performance Plots – 660-820 MHz Reference Design

Test conditions unless otherwise noted: $V_{CC} = V_{BIAS} = +5.0\text{ V}$, $V_{PD} = +1.8\text{ V}$, $I_{CQ} = 235\text{ mA}$, $Temp = +25\text{ }^{\circ}\text{C}$, $50\text{ }\Omega$ system.

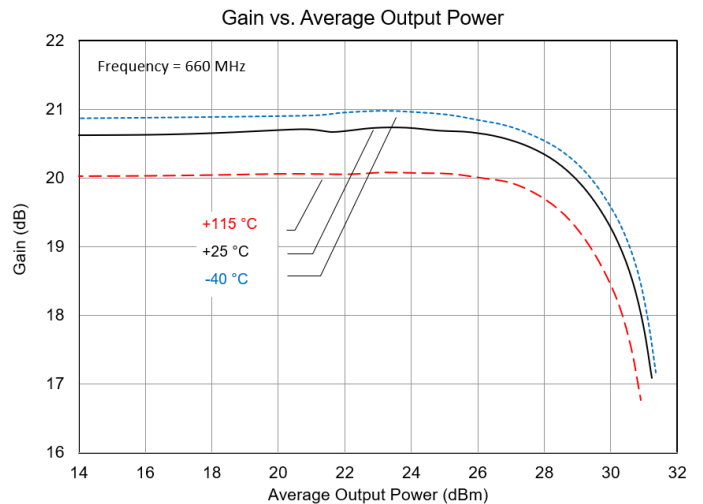
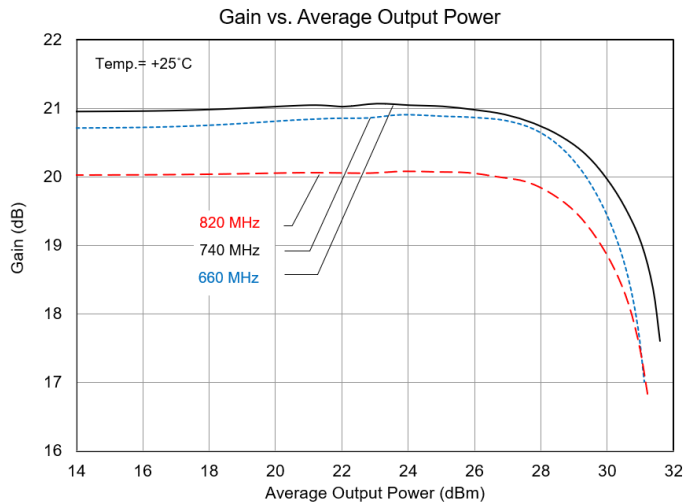
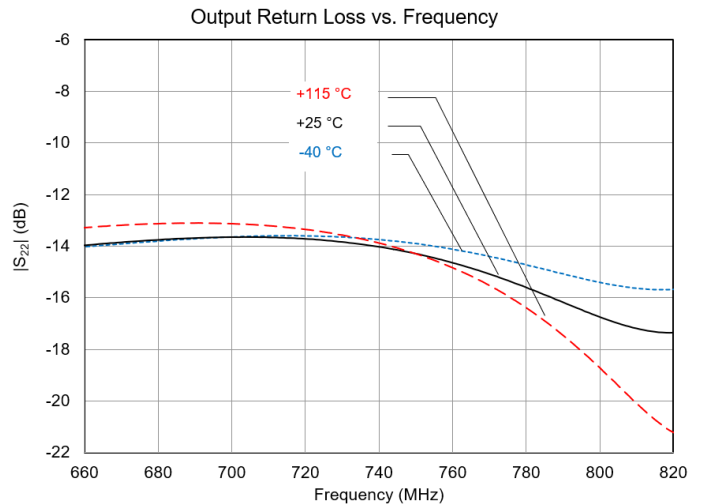
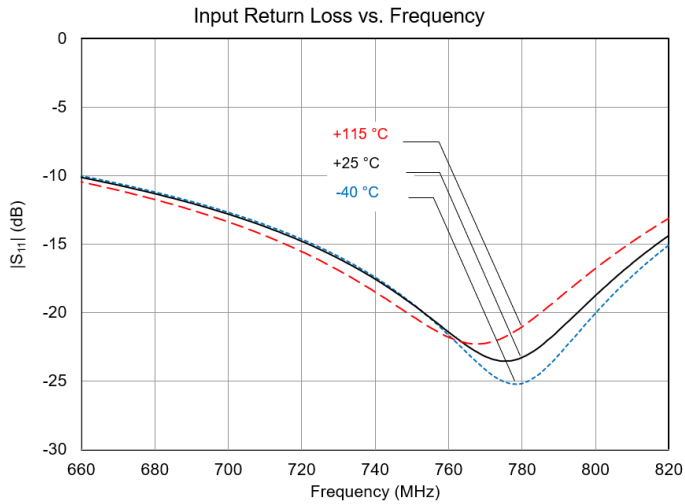
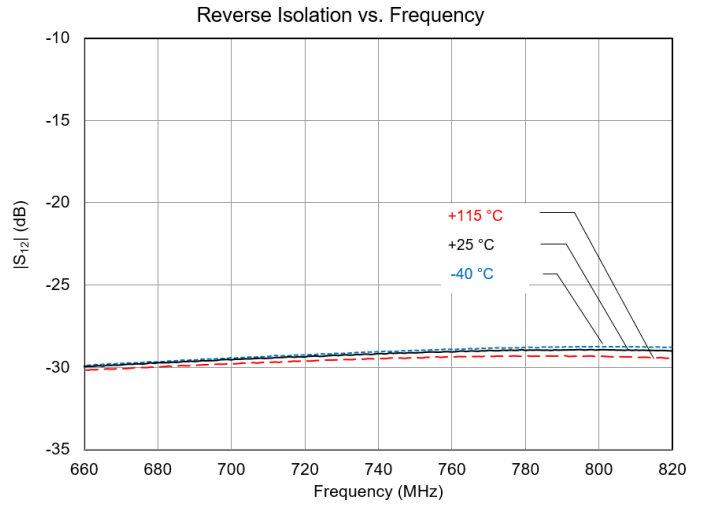
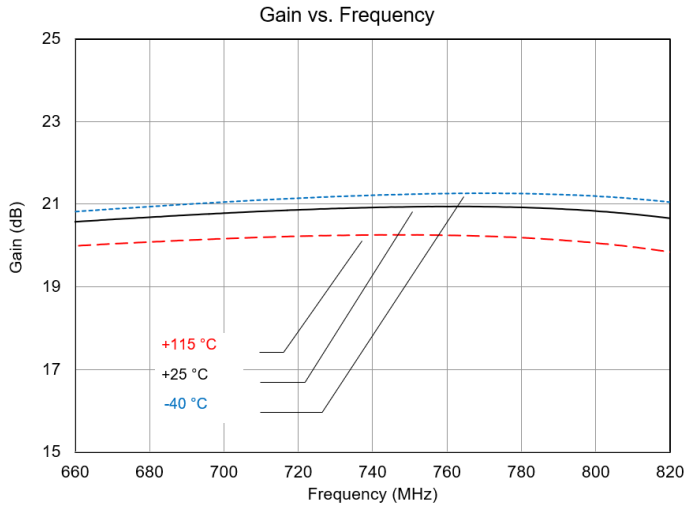

Performance Plots – 660-820 MHz Reference Design – Continued

Test conditions unless otherwise noted: $V_{CC} = V_{BIAS} = +5.0\text{ V}$, $V_{PD} = +1.8\text{ V}$, $I_{CQ} = 235\text{ mA}$, Temp = $+25\text{ }^{\circ}\text{C}$, $50\text{ }\Omega$ system.

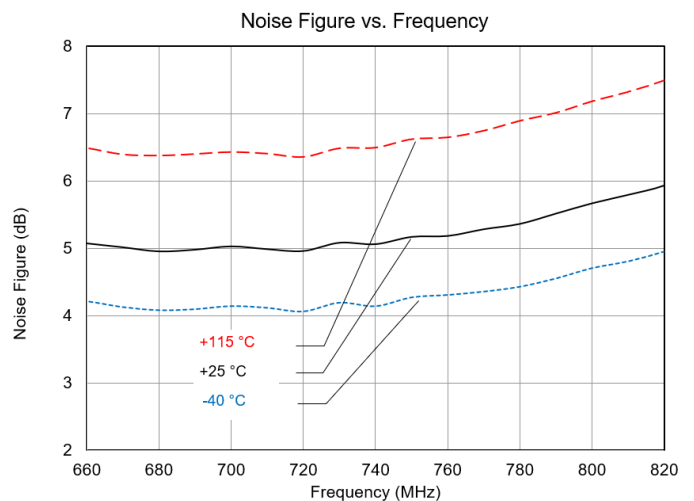
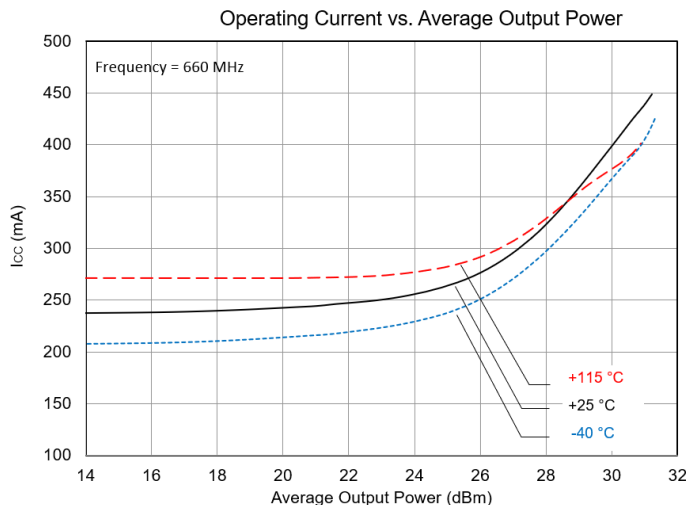
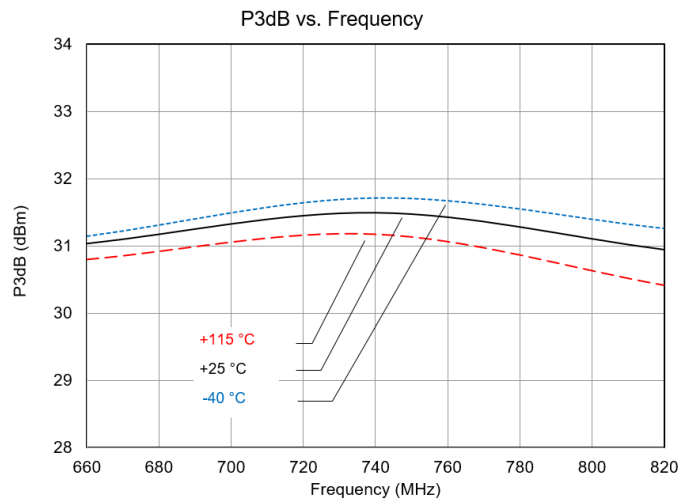
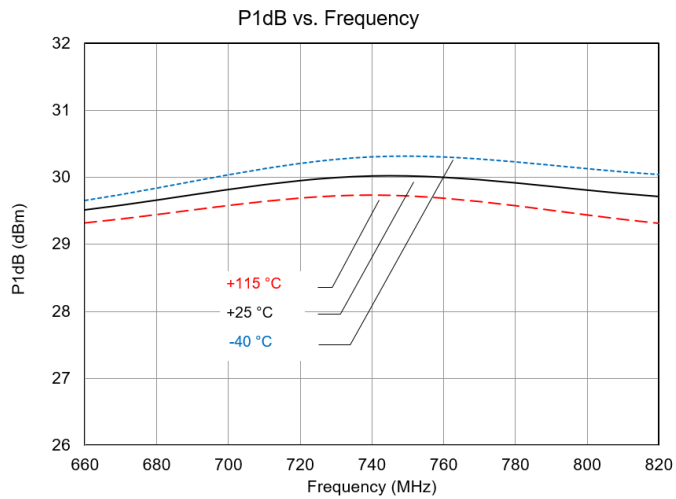
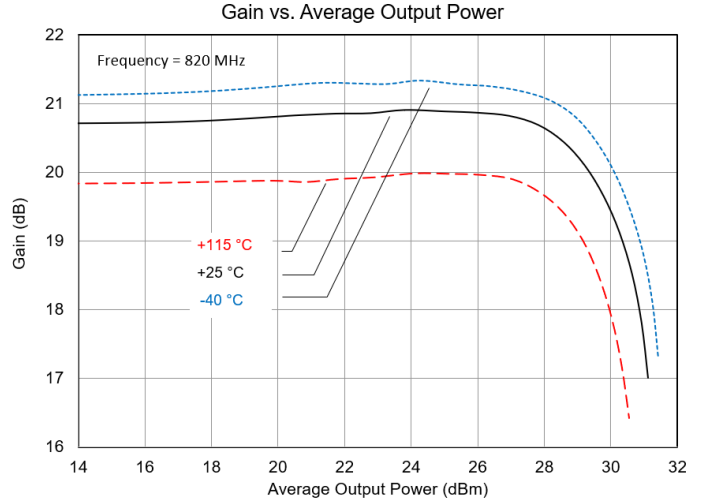
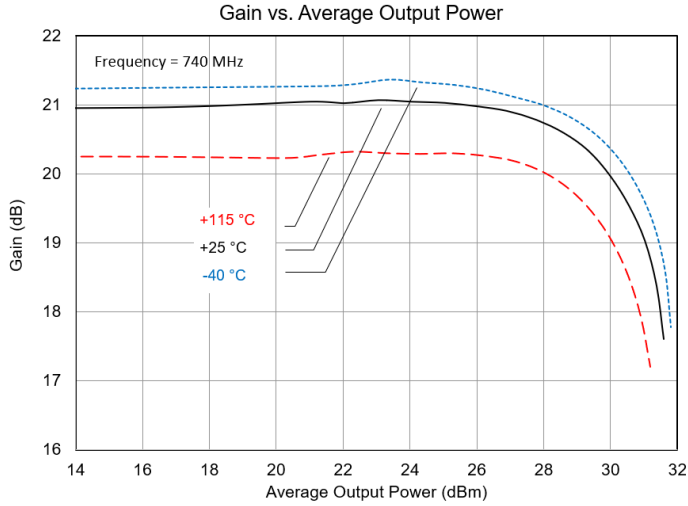

Performance Plots – 660-820 MHz Reference Design – Continued

Test conditions unless otherwise noted: $V_{CC} = V_{BIAS} = +5.0V$, $V_{PD} = +1.8V$, $I_{CQ} = 235\text{ mA}$, $Temp = +25\text{ }^{\circ}\text{C}$, $50\ \Omega$ system.

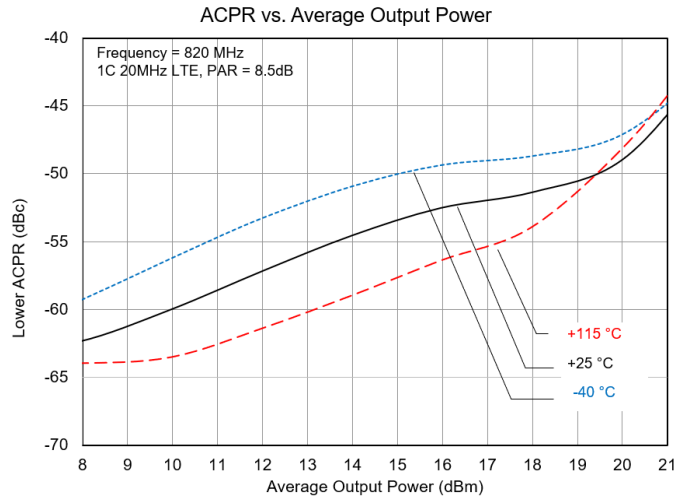
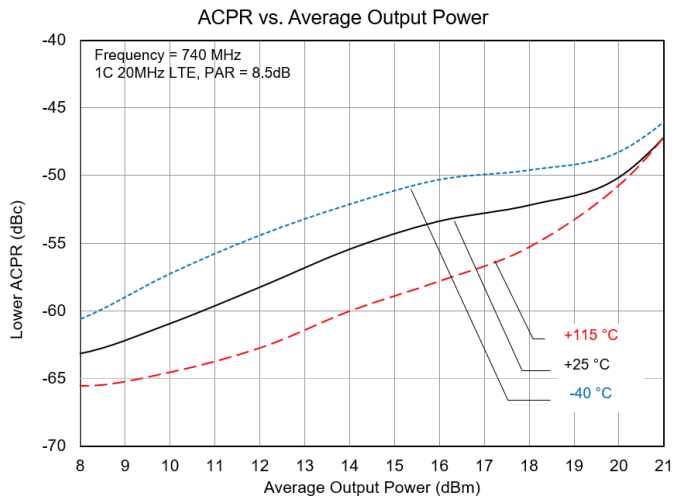
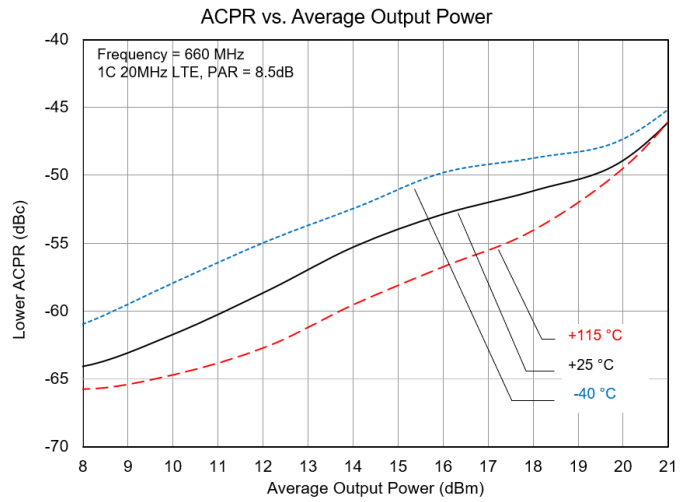
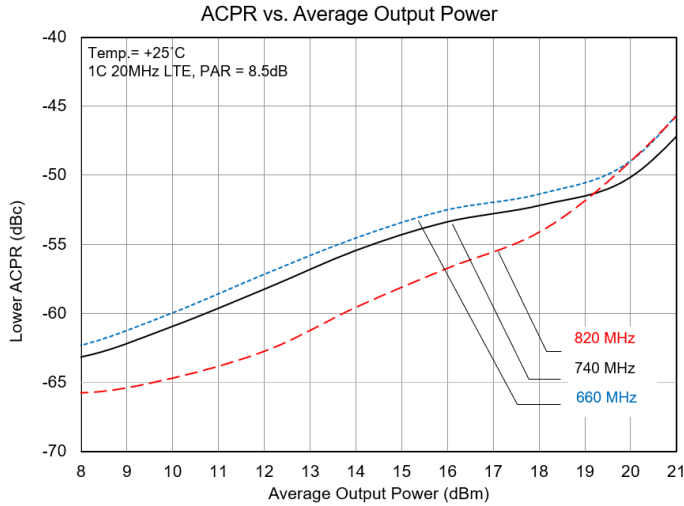

Evaluation Board, 3400 – 3800 MHz Reference Design

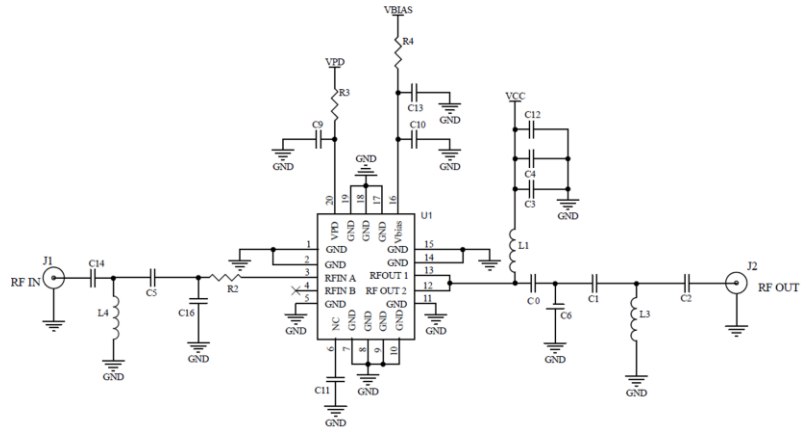
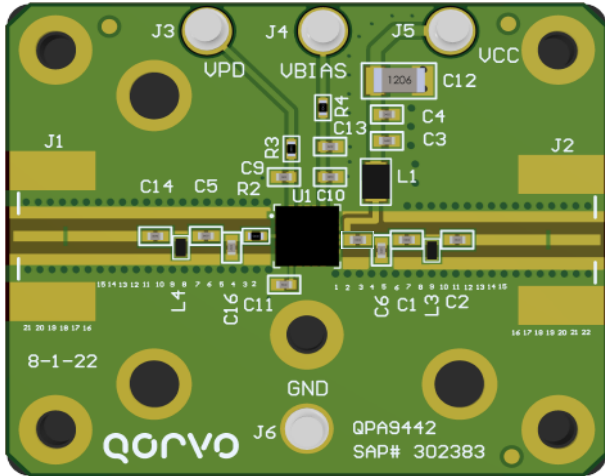

Notes:

- Components shown on the PCB layout but not on the schematic are not used.

Bill of Material, 3400 – 3800 MHz

Reference Des.	Value	Description	Manuf.	Part Number
n/a	n/a	Printed Circuit Board	Qorvo	
U1	n/a	1 W High Linearity Amplifier	Qorvo	QPA9442
C14	1.0 nH	IND, 0402, ±5%	Various	
C5	1.5 pF	CAP, 0402, ±0.05pF, 100V, C0G	Various	
C16	1.0 pF	CAP, 0402, ±0.05pF, 100V, C0G	Various	
C3, C9, C10	220 pF	CAP, 0402, 5%, 50V, C0G	Various	
C4, C13	1 µF	CAP, 0402, 10%, 10V, X7S	Various	
C12	10 µF	CAP, 1206, 10%, 25V, X7R	Various	
L4, C11	DNP	n/a	n/a	
L3	0.5 pF	CAP, 0402, ±0.05pF, 100V, C0G	Various	
L1	5.6 nH	IND, 0805, 5%, W/W	Coilcraft	0805CS-050XJLB
C6	3.0 nH	IND, 0402, ±5%	Various	
R2	1.2 pF	CAP, 0402, ±0.05pF, 100V, C0G	Various	
R3, R4, C1	0 Ω	RES, 0402, 1/10W	Various	
C0	1.5 pF	CAP, 0402, ±0.05pF, 100V, C0G	Various	
C2	22 pF	CAP, 0402, ±5%, 50V, C0G	Various	

Typical Performance, 3400 – 3800 MHz Reference Design

Parameter	Conditions	Typical Value			Units
		3400	3600	3800	
Frequency		3400	3600	3800	MHz
Gain		14.2	15.6	14.4	dB
Input Return Loss		5.8	16.4	7.3	dB
Output Return Loss		10.7	8.9	8.0	dB
Output P1dB		28.5	29.1	29.5	dB
Output P3dB		31.5	31.0	31.0	dBm
Output IP3	P _{out} = +10dBm/tone, Δf = 1MHz	43.2	42.6	41.3	dBm
ACPR	P _{out} =+17 dBm, 1C LTE, 20MHz, 8.5dB PAR	-48.5	-50.5	-48.4	dBc
Noise Figure		4.6	4.0	4.3	dB
Device Current	V _{CC} and V _{BIAS} combined	235			mA

Notes:

1. Test Conditions unless otherwise noted: V_{CC} = V_{BIAS} = +5.0 V, V_{PD} = +1.8 V, I_{CC} = 235 mA, Temp = +25 °C, 50 Ω system.

Logic Table

Parameter, V _{PD}	High	Low
Device State	ON	OFF

Performance Plots – 3400-3800 MHz Reference Design

Test conditions unless otherwise noted: $V_{CC} = V_{BIAS} = +5.0V$, $V_{PD} = +1.8V$, $I_{CQ} = 235\text{ mA}$, Temp = +25 °C, 50 Ω system.

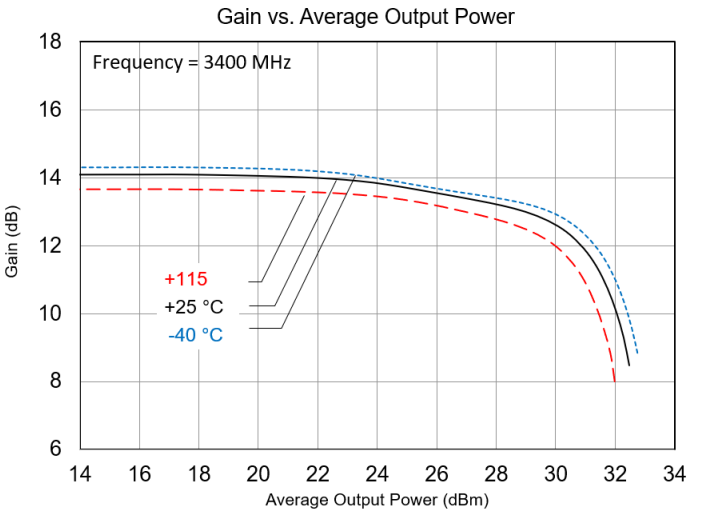
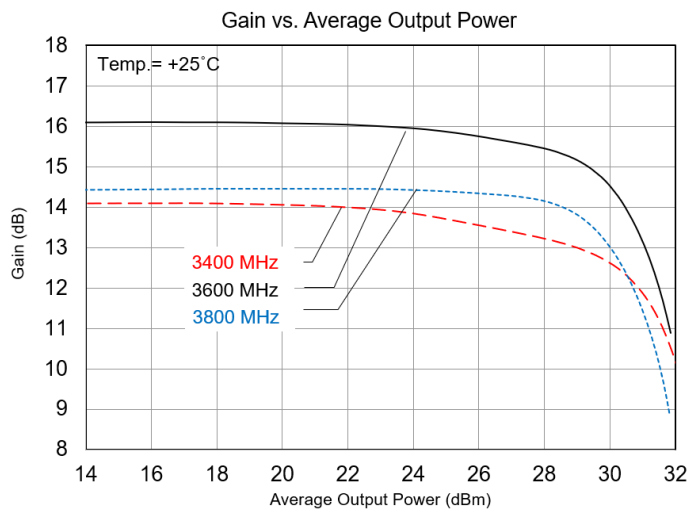
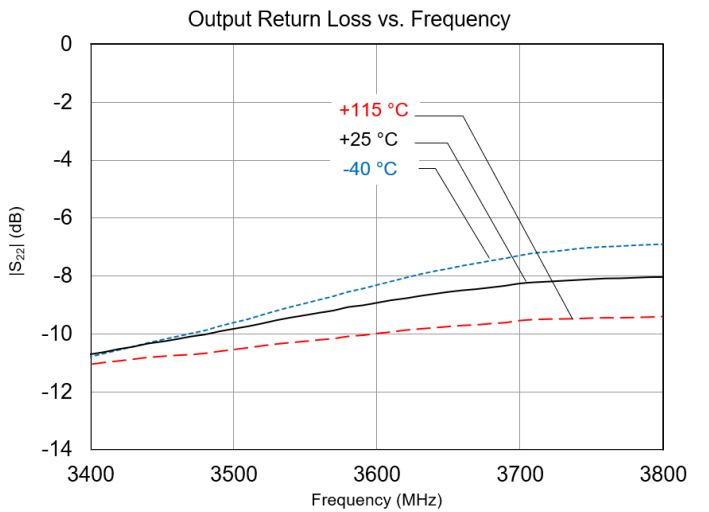
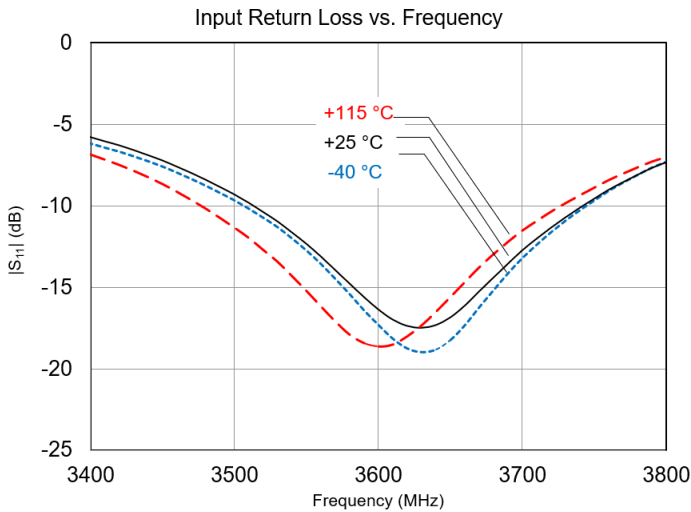
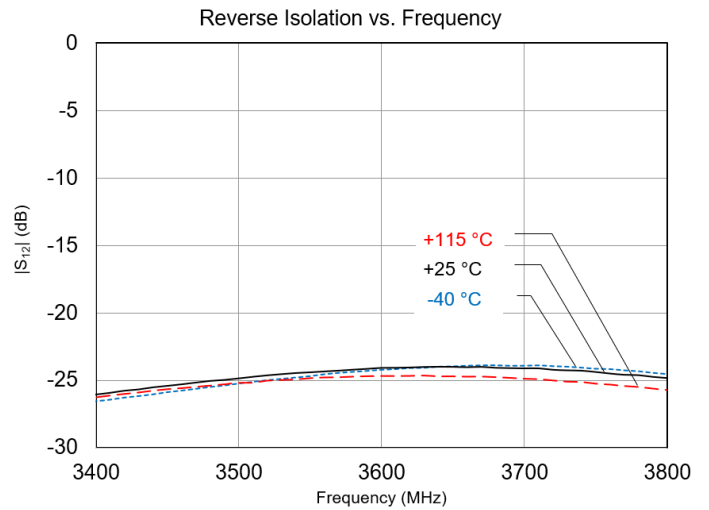
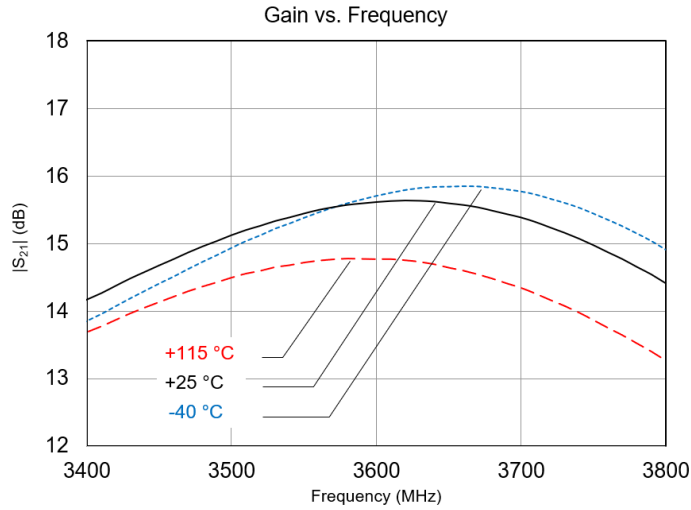

Performance Plots – 3400-3800 MHz Reference Design – Continued

Test conditions unless otherwise noted: $V_{CC} = V_{BIAS} = +5.0\text{ V}$, $V_{PD} = +1.8\text{ V}$, $I_{CCQ} = 235\text{ mA}$, $\text{Temp} = +25\text{ }^{\circ}\text{C}$, $50\text{ }\Omega$ system.

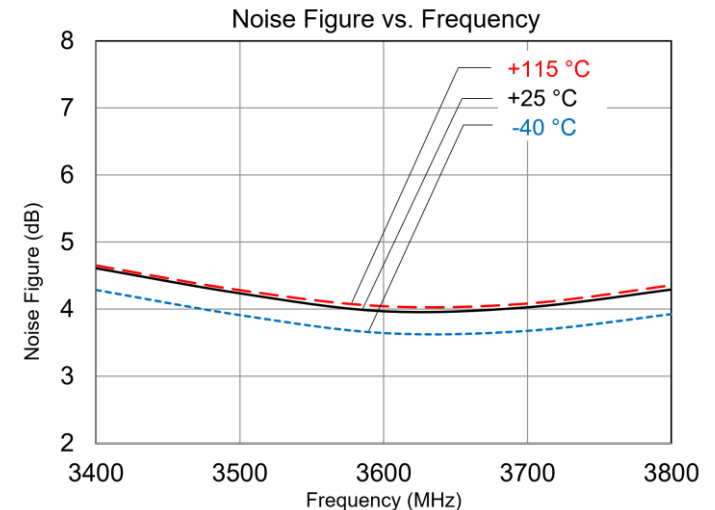
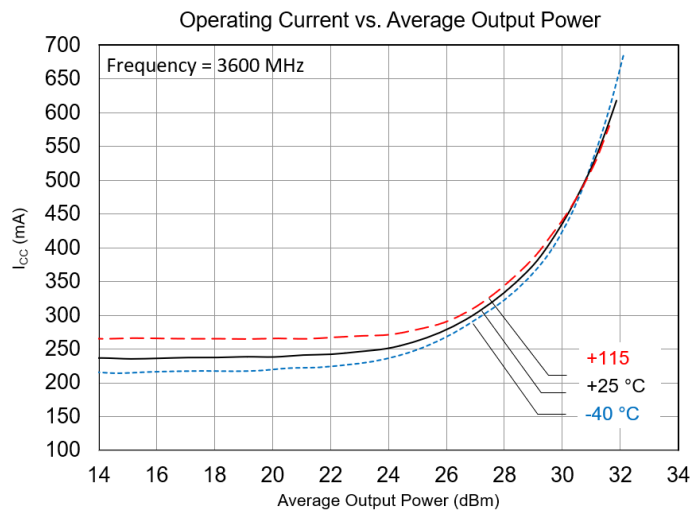
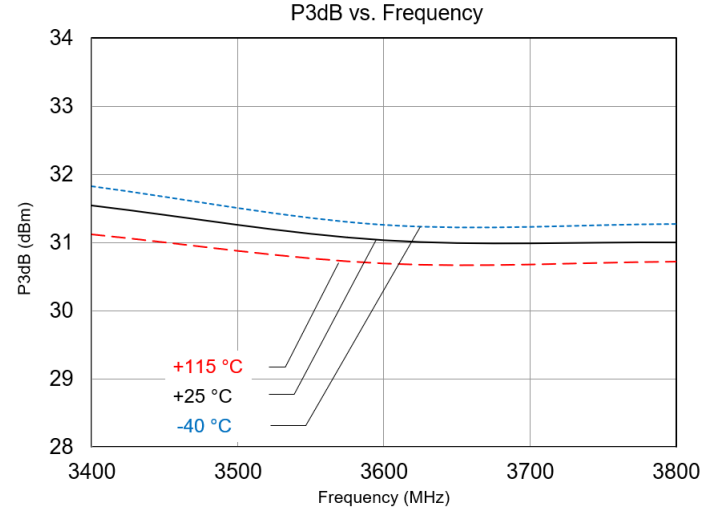
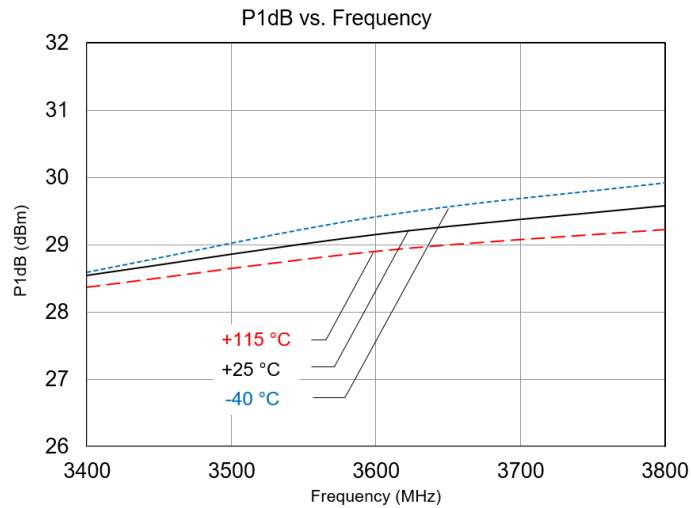
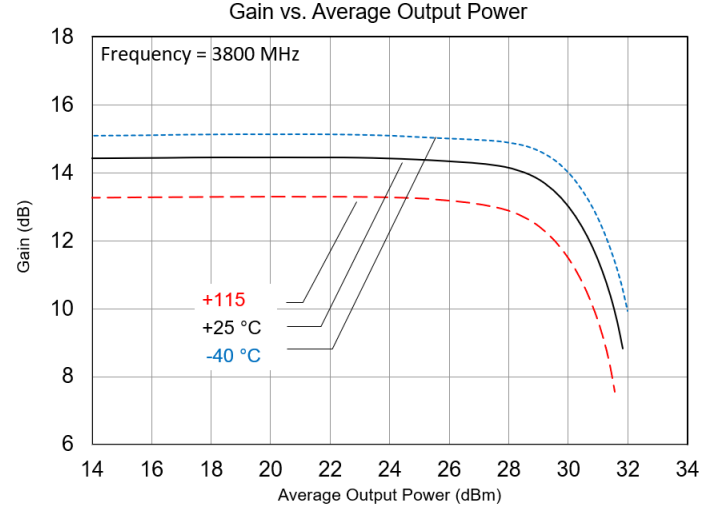
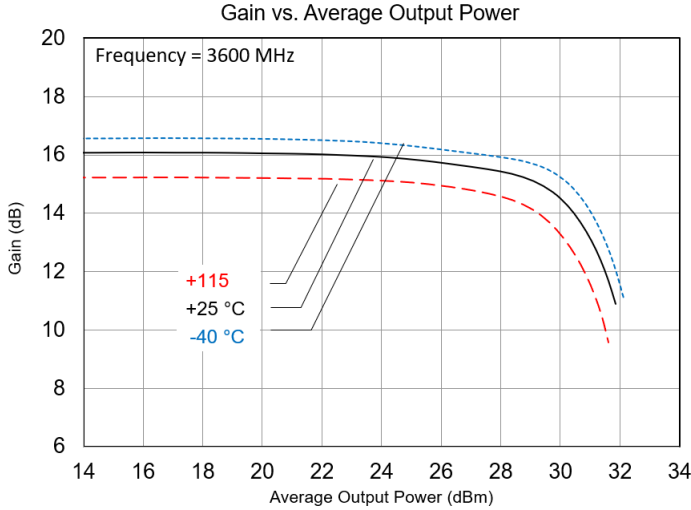

Performance Plots – 3400-3800 MHz Reference Design – Continued

Test conditions unless otherwise noted: $V_{CC} = V_{BIAS} = +5.0V$, $V_{PD} = +1.8V$, $I_{CO} = 235\text{ mA}$, Temp = +25 °C, 50 Ω system.

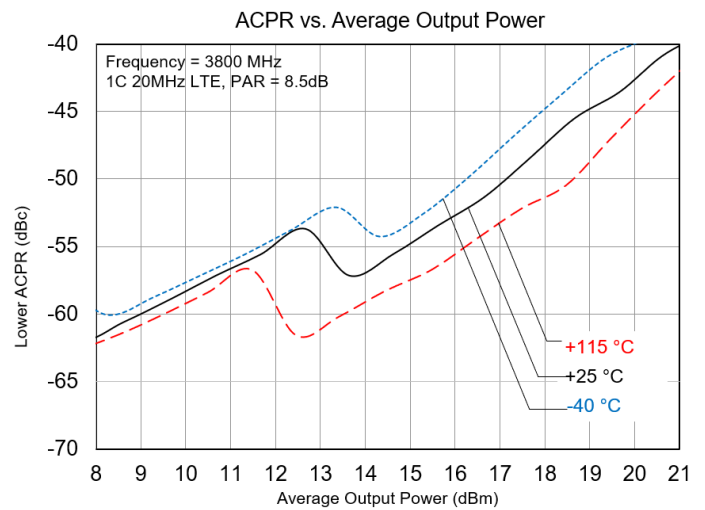
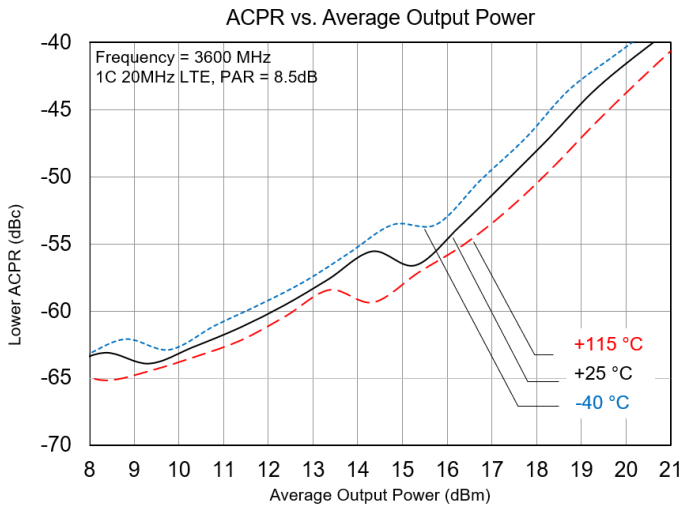
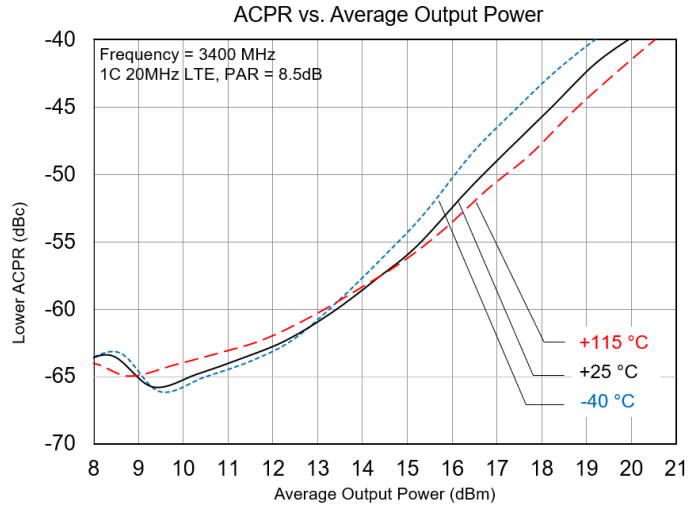
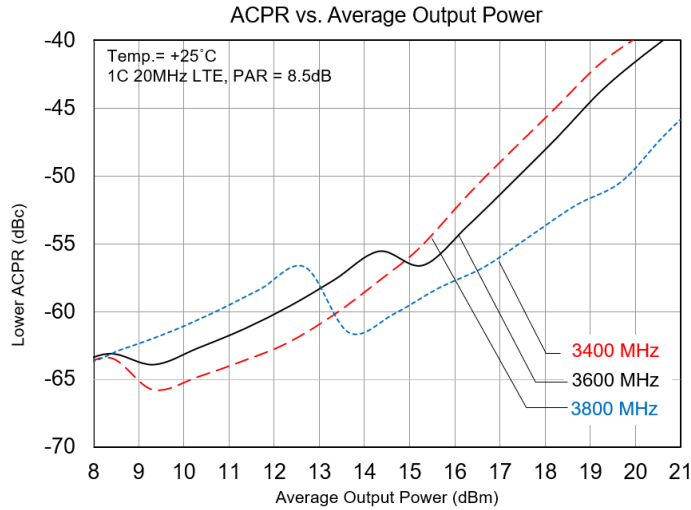

Performance Plots – 3400-3800 MHz Reference Design – Continued

Test conditions unless otherwise noted: $V_{CC} = V_{BIAS} = +5.0V$, $V_{PD} = +1.8V$, $I_{CQ} = 235\text{ mA}$, Temp = $+25^\circ\text{C}$, $50\ \Omega$ system.

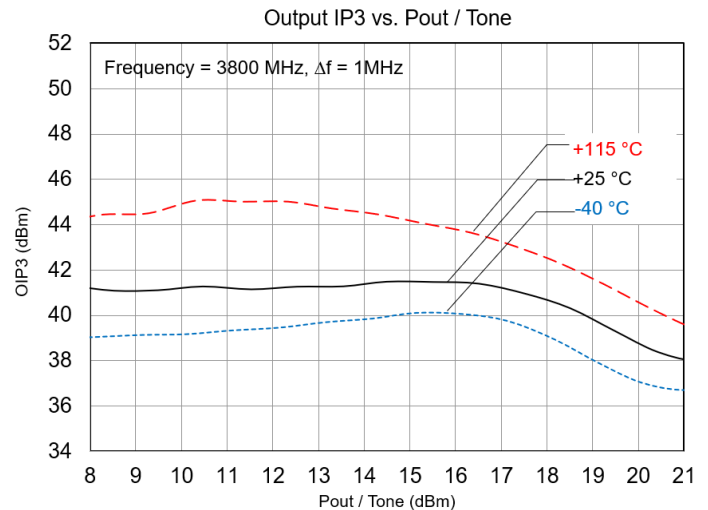
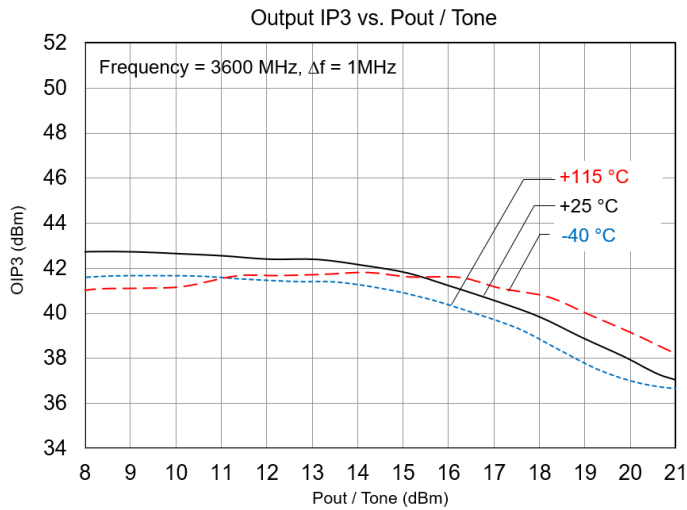
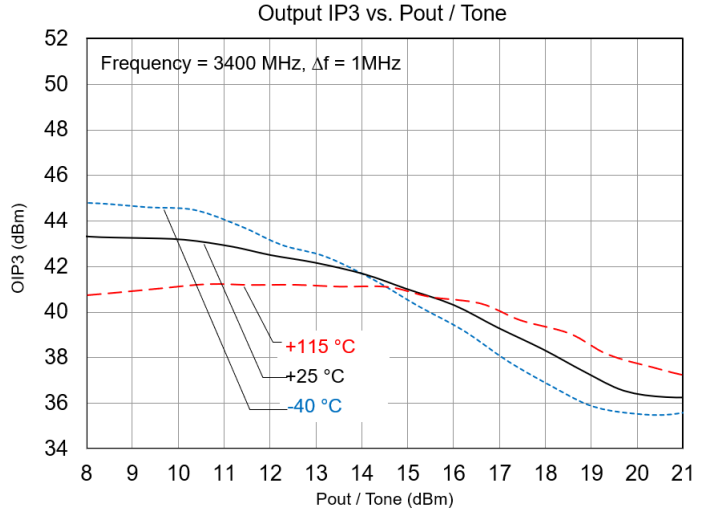
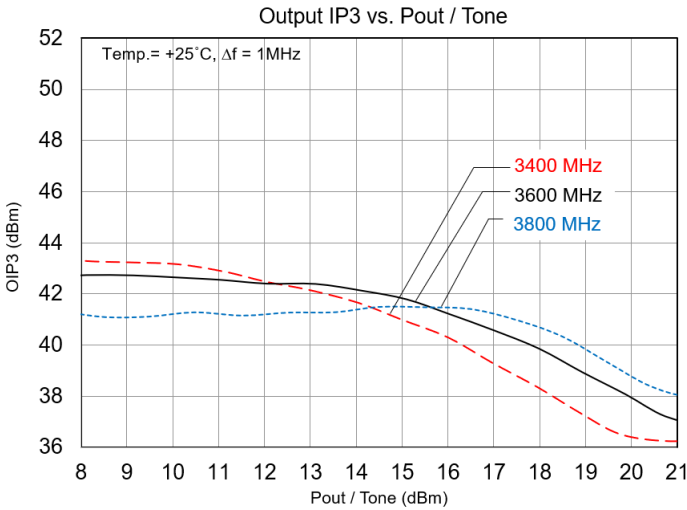

Typical Performance, 4800 – 5000 MHz Reference Design

Parameter	Conditions	Typical Value			Units
		4800	4900	5000	
Frequency		4800	4900	5000	MHz
Gain		12.5	12.8	12.7	dB
Input Return Loss		7.1	7.8	9.1	dB
Output Return Loss		11.3	13.8	16.1	dB
Output P1dB		29.7	29.6	28.9	dB
Output P3dB		31.7	30.9	30.0	dBm
Output IP3	P _{out} = +10dBm/tone, Δf = 1MHz	38.3	37.3	36.1	dBm
ACPR	P _{out} =+17 dBm, 1C LTE, 20MHz, 8.5dB PAR	-40.7	-41.8	-45.5	dBc
Noise Figure		4.3	4.2	4.2	dB
Device Current	V _{CC} and V _{BIAS} combined	235			mA

Notes:

1. Test Conditions unless otherwise noted: V_{CC} = V_{BIAS} = +5.0 V, V_{PD} = +1.8 V, I_{CO} = 235 mA, Temp = +25 °C, 50 Ω system.

Performance Plots – 4800-5000 MHz Reference Design

Test conditions unless otherwise noted: $V_{CC} = V_{BIAS} = +5.0\text{ V}$, $V_{PD} = +1.8\text{ V}$, $I_{CQ} = 235\text{ mA}$, $\text{Temp} = +25\text{ }^\circ\text{C}$, $50\ \Omega$ system.

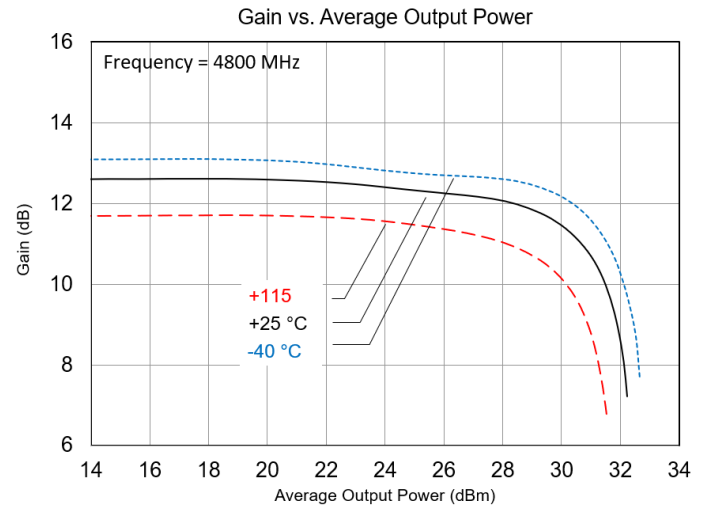
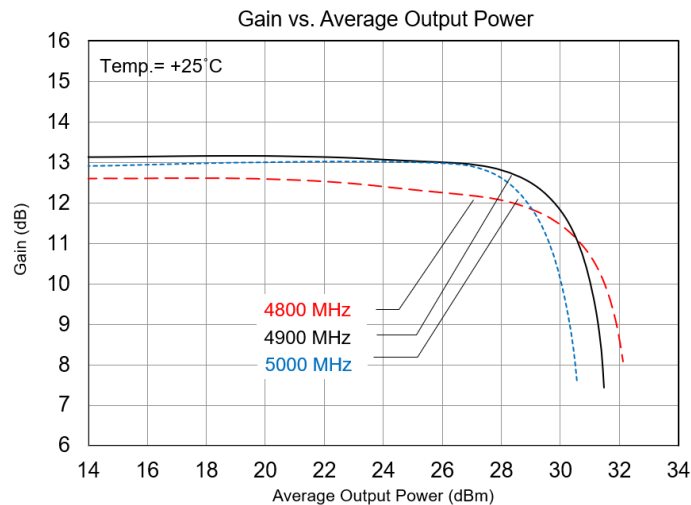
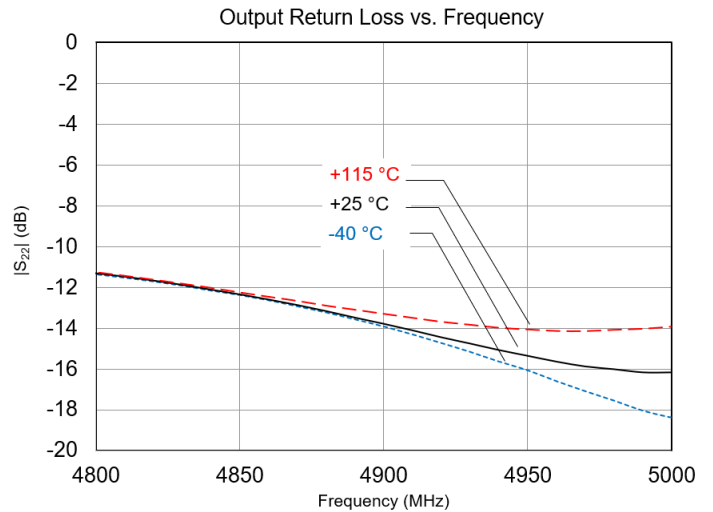
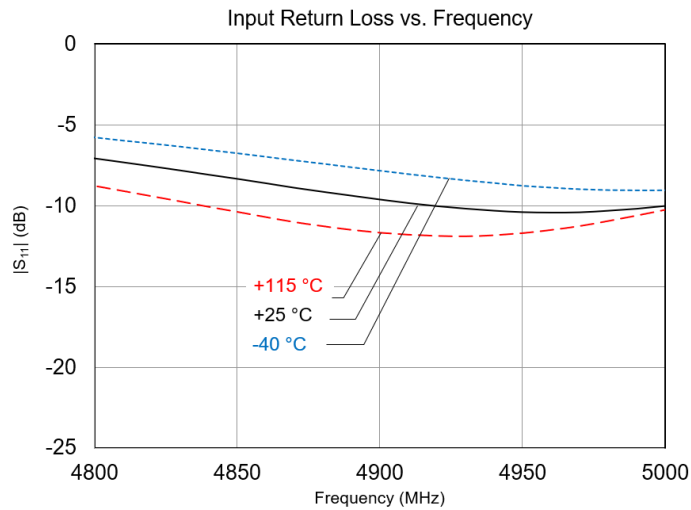
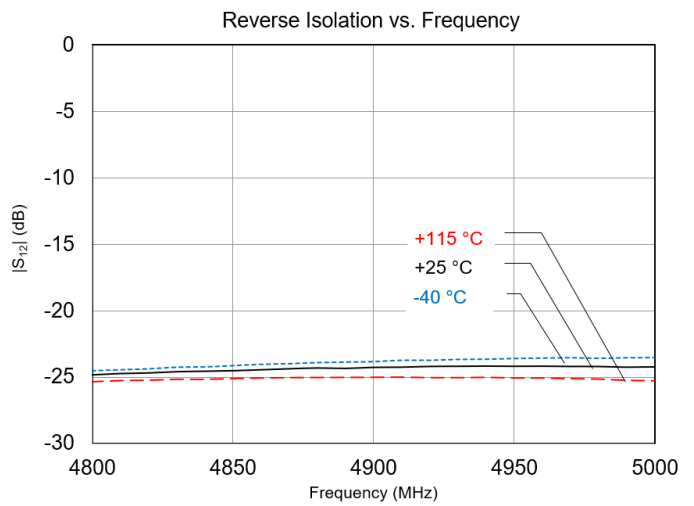
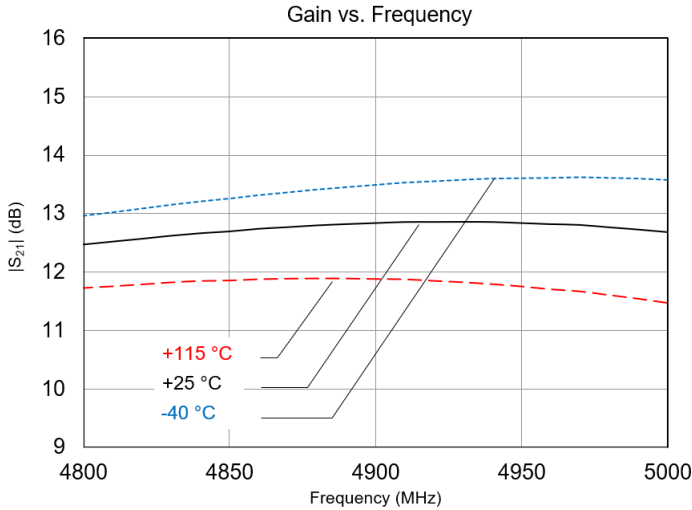

Performance Plots – 4800-5000 MHz Reference Design – Continued

Test conditions unless otherwise noted: $V_{CC} = V_{BIAS} = +5.0\text{ V}$, $V_{PD} = +1.8\text{ V}$, $I_{CQ} = 235\text{ mA}$, $\text{Temp} = +25\text{ }^\circ\text{C}$, $50\ \Omega$ system.

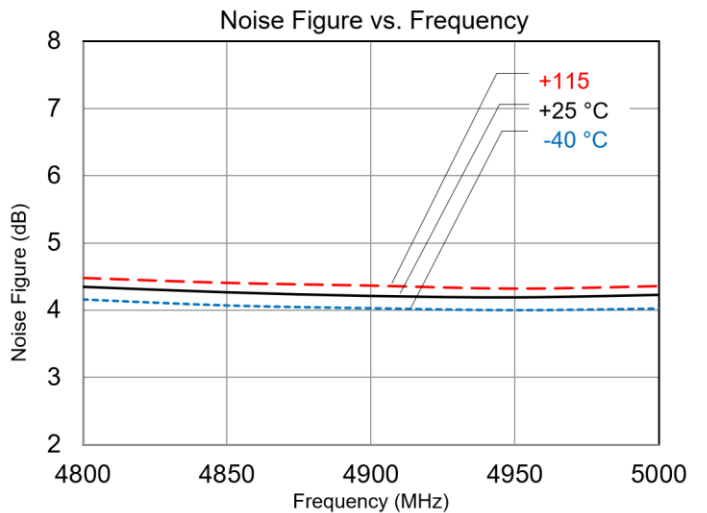
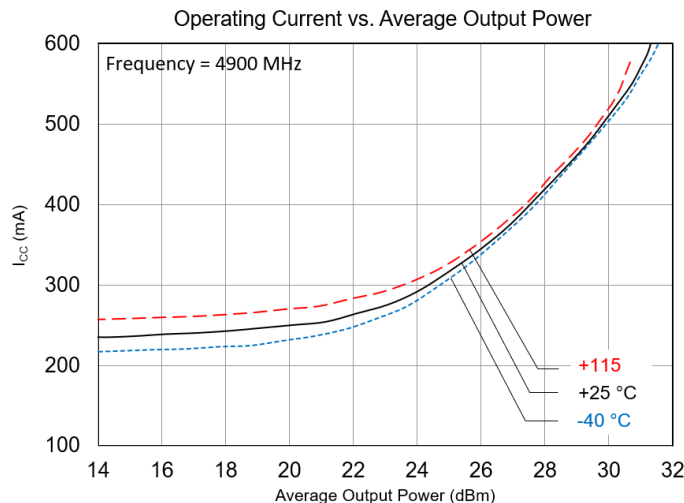
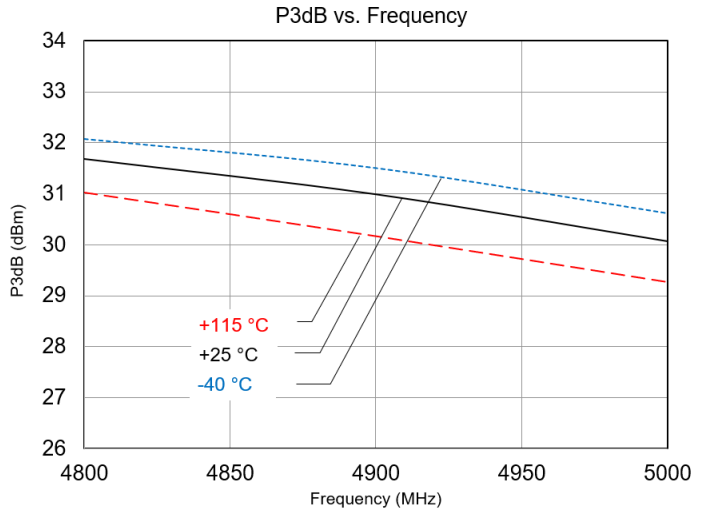
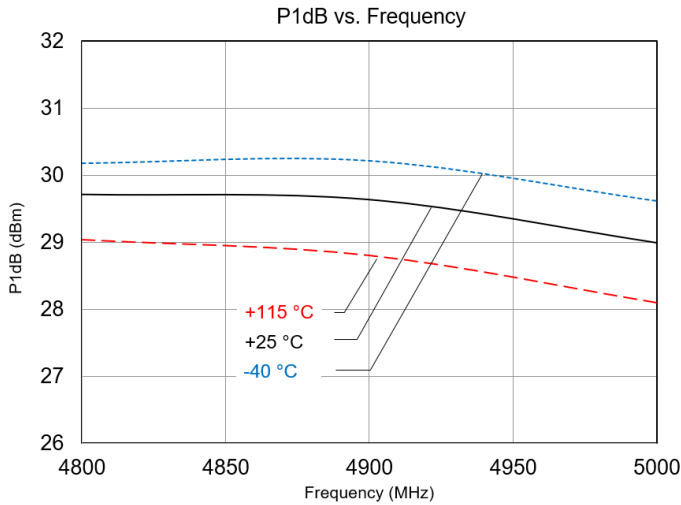
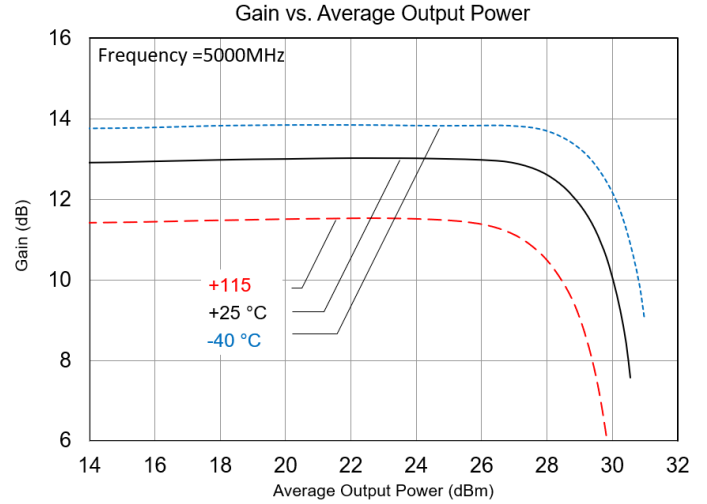
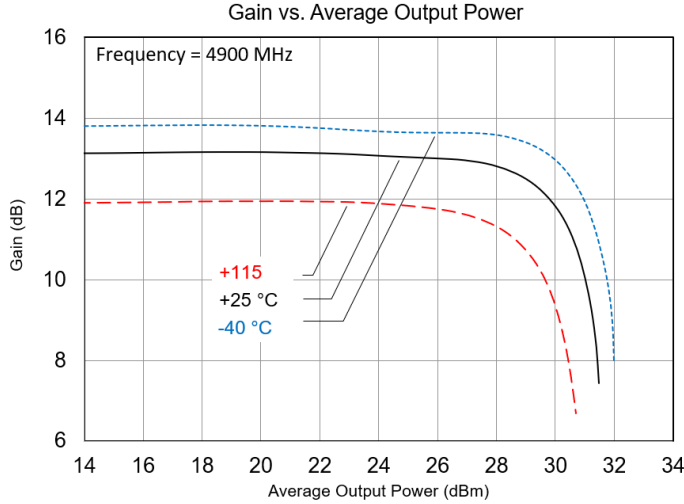

Performance Plots – 4800-5000 MHz Reference Design – Continued

Test conditions unless otherwise noted: $V_{CC} = V_{BIAS} = +5.0V$, $V_{PD} = +1.8V$, $I_{CQ} = 235\text{ mA}$, $Temp = +25\text{ }^{\circ}\text{C}$, $50\text{ }\Omega$ system.

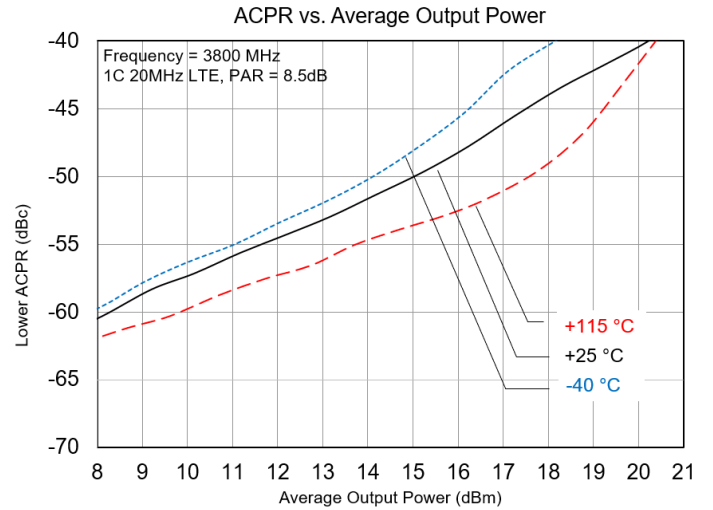
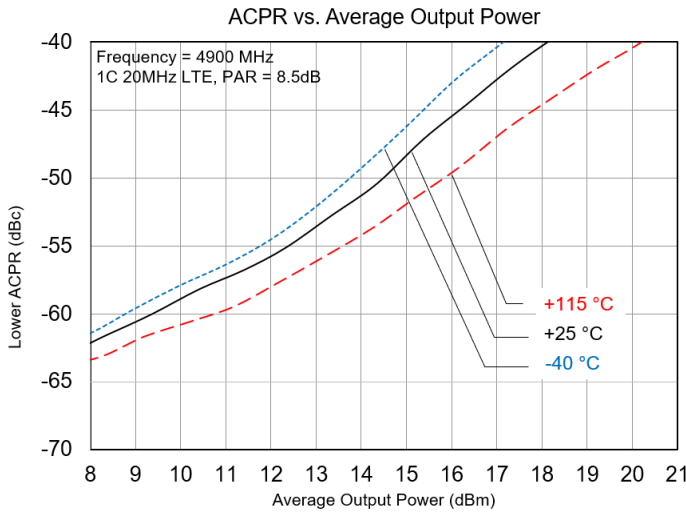
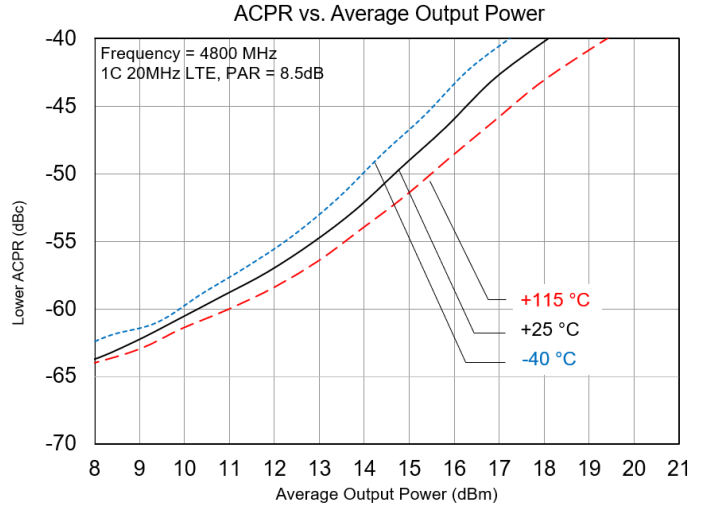
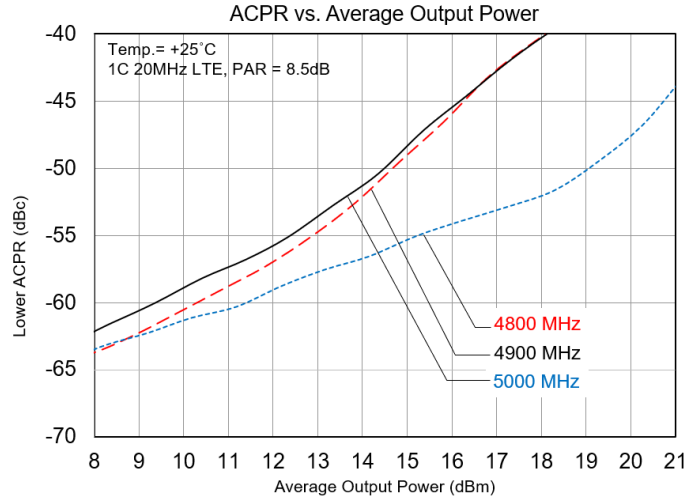

Performance Plots – 4800-5000 MHz Reference Design – Continued

Test conditions unless otherwise noted: $V_{CC} = V_{BIAS} = +5.0V$, $V_{PD} = +1.8V$, $I_{CQ} = 235\text{ mA}$, Temp = $+25^\circ\text{C}$, $50\ \Omega$ system.

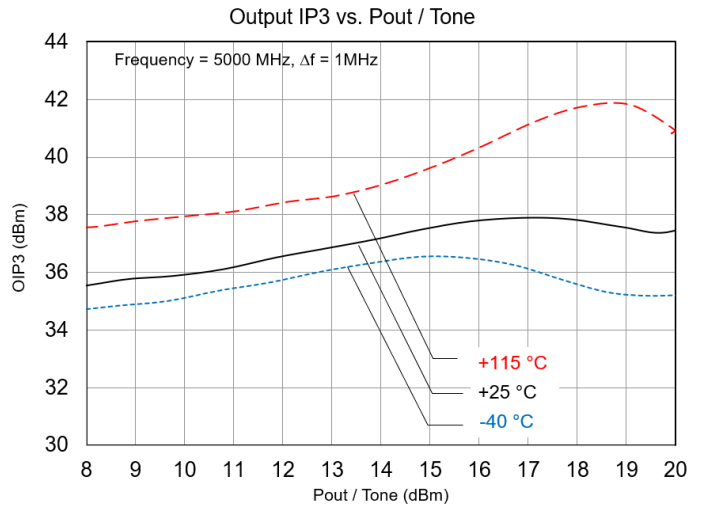
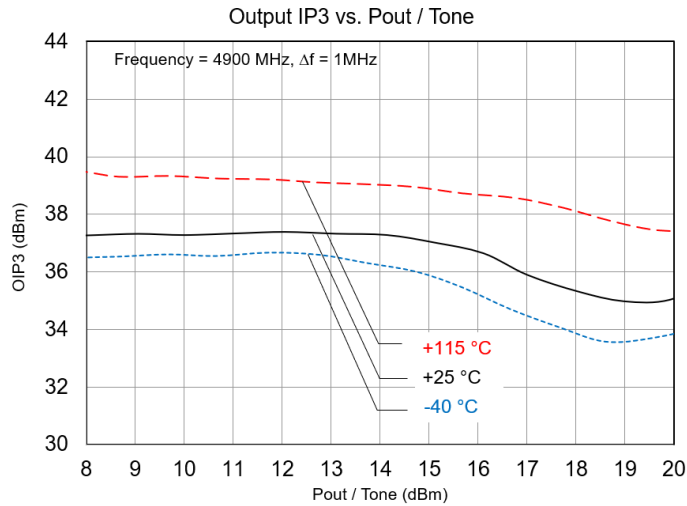
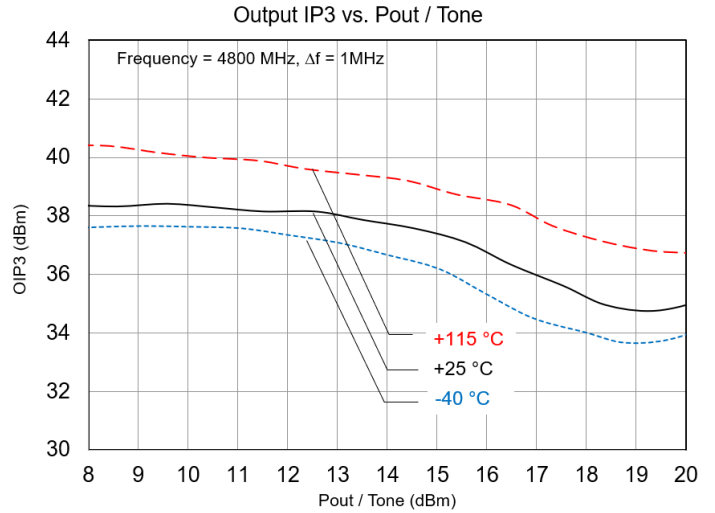
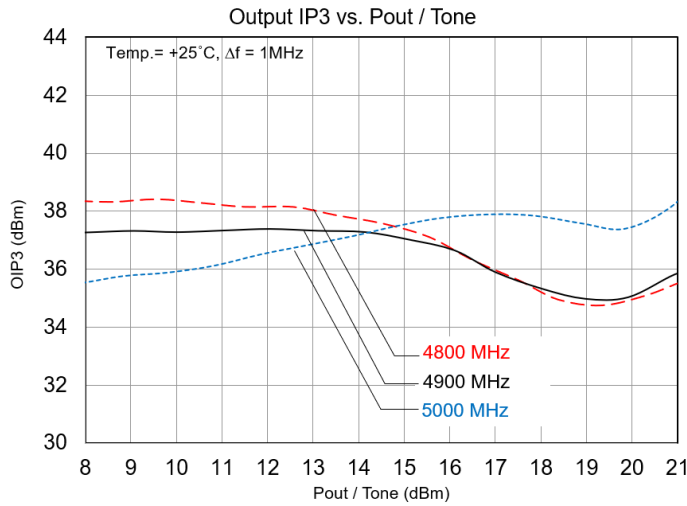

Pad Configuration and Description

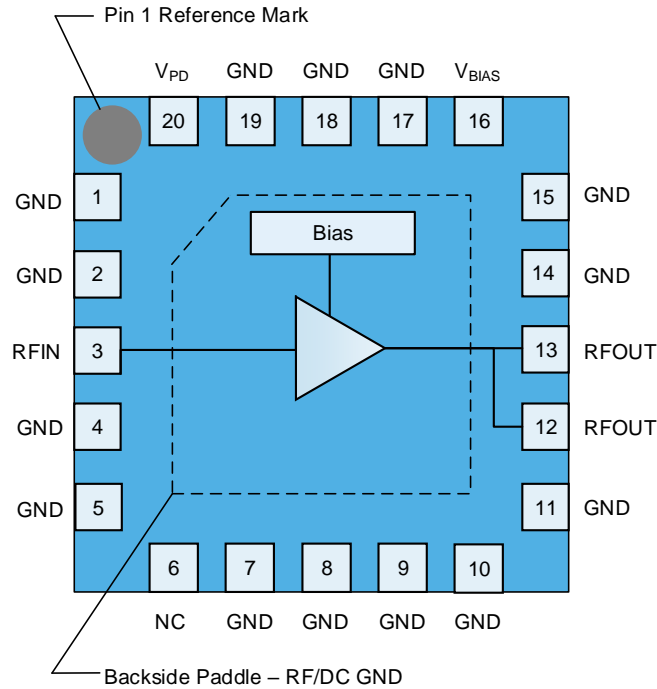

Top View

Pad No.	Label	Description
1, 2, 4, 5, 7, 8, 9, 10, 11, 14, 15, 17, 18, 19	GND	RF/DC ground connection.
3	RFIN	RF input. External DC block required.
6	NC	No electrical connection internally. It may be left floating or connected to ground. Land pads should be provided for PCB mounting integrity.
12, 13	RFOUT / V _{CC}	RF output and DC supply. External choke and DC block capacitor required.
16	V _{BIAS}	Bias circuit supply voltage.
20	V _{PD}	PA on/off logic control.
Backside Paddle	GND	RF/DC ground connection. The back side of the package should be connected to the ground plane through as short of a connection as possible. PCB vias under the device as many as possible are recommended.

Biasing Procedure

Bias On	Bias Off
1. V _{CC} = V _{BIAS} = +5.0V	1. Turn RF off
2. V _{PD} = +1.8V	2. V _{PD} = 0V
3. Turn RF On	3. V _{CC} = V _{BIAS} = 0V

Package Marking and Dimensions

Marking: QR Code – Contains device traceability information
 Part No. – A9442
 Trace Code to be assigned by sub-contractor

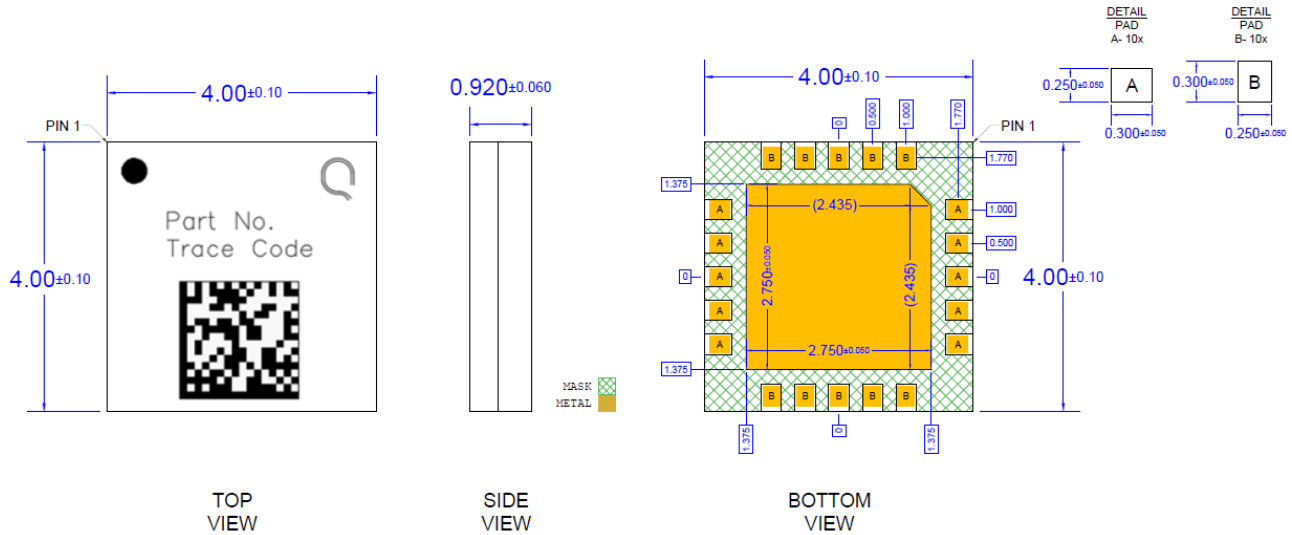

- Notes:
1. All dimensions are in millimeters. Angles are in degrees.
 2. The terminal #1 identifier and terminal numbering conform to SPE-000677.
 3. Contact plating: ENEPIG

Recommended PCB Layout Pattern

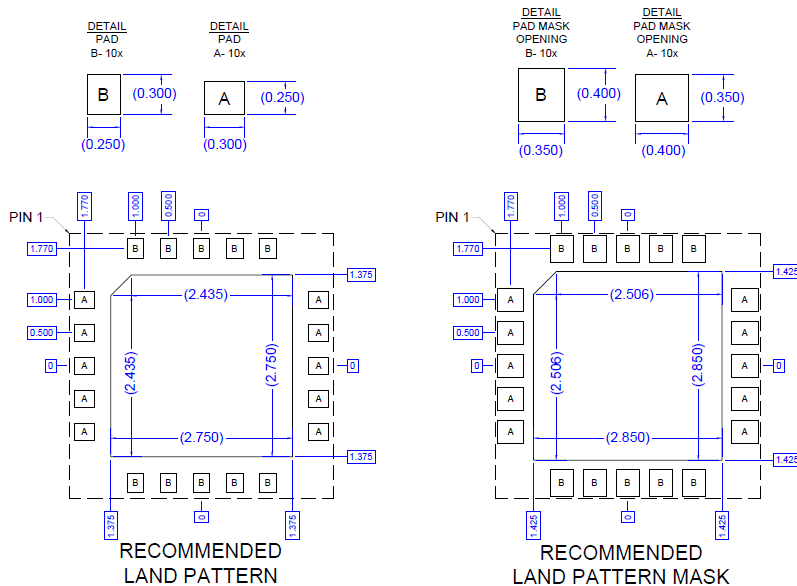

- Notes:
1. All dimensions are in millimeters. Angles are in degrees.
 2. Use 1 oz. copper minimum for top and bottom layer metal.
 3. Via holes are required under the backside paddle of this device for proper RF/DC grounding and thermal dissipation. We recommend a 0.35mm (#80/.0135") diameter bit for drilling via holes and a final plated thru diameter of 0.25 mm (0.01").
 4. Ensure good package backside paddle solder attach for reliable operation and best electrical performance.

Tape and Reel Information – Carrier and Cover Tape Dimensions

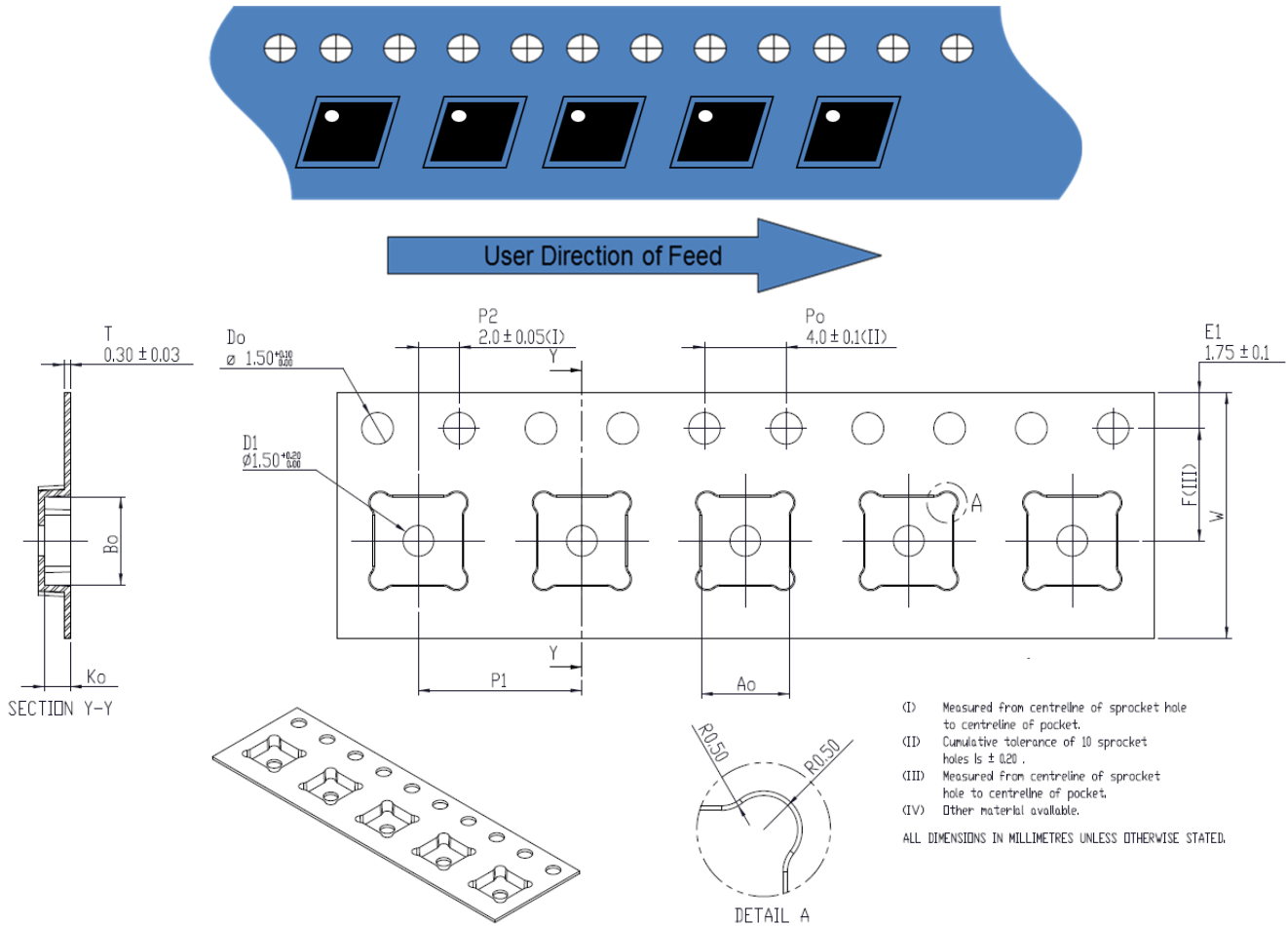

Feature	Measure	Symbol	Size (in)	Size (mm)
Cavity	Length	A0	0.169	4.30
	Width	B0	0.169	4.30
	Depth	K0	0.049	1.25
	Pitch	P1	0.315	8.00
Centerline Distance	Cavity to Perforation - Length Direction	P2	0.079	2.00
	Cavity to Perforation - Width Direction	F	0.217	5.50
Cover Tape	Width	C	0.362	9.20
Carrier Tape	Width	W	0.472	12.0

Tape and Reel Information – Reel Dimensions

Standard T/R size = 2,500 pieces on a 13" reel.

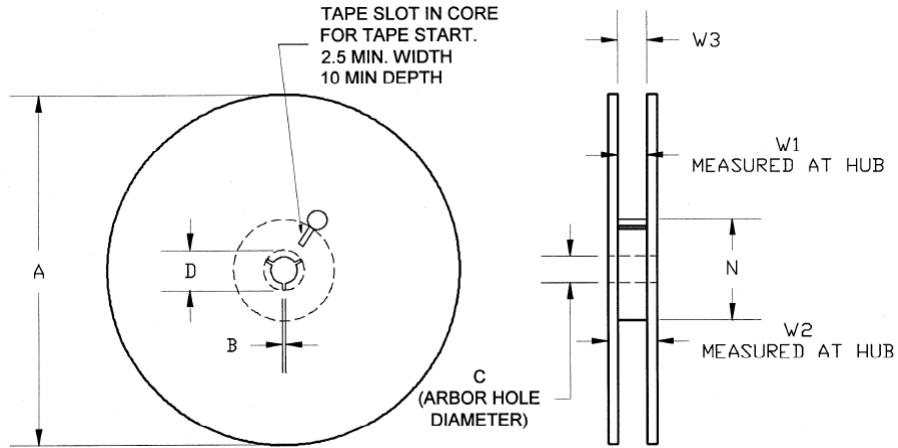

Feature	Measure	Symbol	Size (in)	Size (mm)
Flange	Diameter	A	12.992	330.0
	Thickness	W2	0.717	18.2
	Space Between Flange	W1	0.504	12.8
Hub	Outer Diameter	N	4.016	102.0
	Arbor Hole Diameter	C	0.512	13.0
	Key Slit Width	B	0.079	2.0
	Key Slit Diameter	D	0.787	20.0

Tape and Reel Information – Tape Length and Label Placement

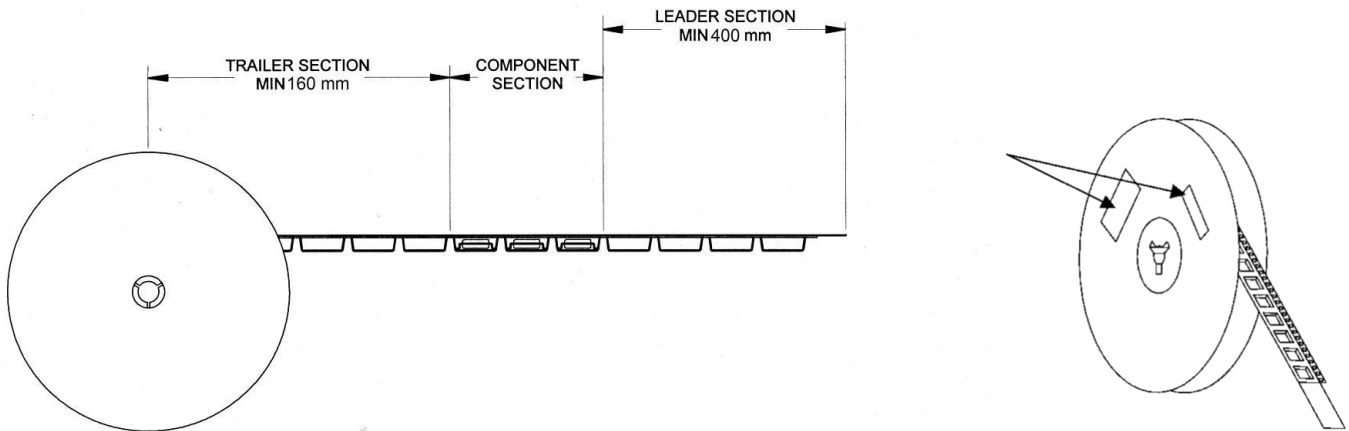

Notes:

1. Empty part cavities at the trailing and leading ends are sealed with cover tape. See EIA 481-1-A.
2. Labels are placed on the flange opposite the sprockets in the carrier tape.

Handling Precautions

Parameter	Rating	Standard
ESD – Human Body Model (HBM)	1C	ESDA / JEDEC JS-001-2017
ESD – Charged Device Model (CDM)	C3	JEDEC JESD22-C101F
MSL – Moisture Sensitivity Level	MSL3	IPC/JEDEC J-STD-020



Caution!
ESD-Sensitive Device

Solderability

Compatible with both lead-free (260°C max. reflow temperature) and tin/lead (245°C max. reflow temperature) soldering processes. Solder profiles available upon request.

Contact plating: ENEPIG

RoHS Compliance

This part is compliant with 2011/65/EU RoHS directive (Restrictions on the Use of Certain Hazardous Substances in Electrical and Electronic Equipment) as amended by Directive 2015/863/EU.

This product also has the following attributes:

- Lead Free
- Halogen Free (Chlorine, Bromine)
- Antimony Free
- TBBP-A (C₁₅H₁₂Br₄O₂) Free
- PFOS Free
- SVHC Free

Contact Information

For the latest specifications, additional product information, worldwide sales and distribution locations:

Web: www.qorvo.com

Tel: 1-844-890-8163

Email: customer.support@qorvo.com

Important Notice

The information contained herein is believed to be reliable; however, Qorvo makes no warranties regarding the information contained herein and assumes no responsibility or liability whatsoever for the use of the information contained herein. All information contained herein is subject to change without notice. Customers should obtain and verify the latest relevant information before placing orders for Qorvo products. The information contained herein or any use of such information does not grant, explicitly or implicitly, to any party any patent rights, licenses, or any other intellectual property rights, whether with regard to such information itself or anything described by such information. **THIS INFORMATION DOES NOT CONSTITUTE A WARRANTY WITH RESPECT TO THE PRODUCTS DESCRIBED HEREIN, AND QORVO HEREBY DISCLAIMS ANY AND ALL WARRANTIES WITH RESPECT TO SUCH PRODUCTS WHETHER EXPRESS OR IMPLIED BY LAW, COURSE OF DEALING, COURSE OF PERFORMANCE, USAGE OF TRADE OR OTHERWISE, INCLUDING THE IMPLIED WARRANTIES OF MERCHANTABILITY AND FITNESS FOR A PARTICULAR PURPOSE.**

Without limiting the generality of the foregoing, Qorvo products are not warranted or authorized for use as critical components in medical, life-saving, or life-sustaining applications, or other applications where a failure would reasonably be expected to cause severe personal injury or death.

Copyright 2025 © Qorvo, Inc. | Qorvo is a registered trademark of Qorvo, Inc.

Looking for pricing, stock, or lifecycle information?

Click below to explore more details on WIN SOURCE:

 [View QPA9442SR on WIN SOURCE](#)

 [Qorvo US Inc. Information](#)

Optimize Your Supply Chain with WIN SOURCE Solutions

-  Global Sourcing Solution
-  Obsolete Management
-  Cost Control Management
-  Shortage Management
-  Alternative Solution
-  Excess Inventory Management