

RFCA8828

High Linearity, Push-Pull Amplifier
50MHz to 1200MHz

The RFCA8828 is a high performance broadband DOCSIS 3.1 MMIC amplifier designed with GaAs pHEMT technology optimized for low noise and high linearity. A Darlington configuration is utilized for broad-band performance with on-chip active bias circuit for consistent bias current and repeatable performance. The RFCA8828 contains two amplifiers used in push-pull configuration for excellent second and third order linearity performance.



Package: SOIC-8

Features

- 5V or 6V Single Supply
- Excellent Linearity Performance at +34dBmV Output Power per Tone
- Two Amplifiers in SOIC-8 Package Simplify Push-Pull Configuration PC Board Layout
- Available in Lead-free, RoHS Compliant, and Green Packaging
- SOIC-8 Package
- 50MHz to 1200MHz operation supporting DOCSIS 3.1

Applications

- CATV Head End Driver and Pre-Driver Amplifier
- CATV Line Driver Amplifier

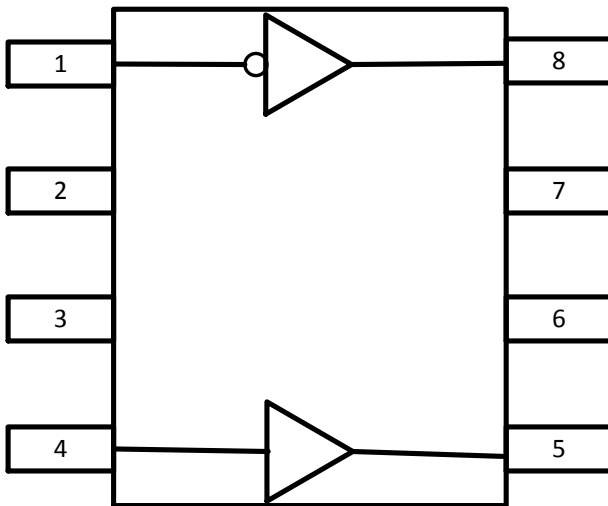

Functional Block Diagram

Ordering Information

RFCA8828SQ	Sample bag with 25 pieces
RFCA8828SR	7" Reel with 100 pieces
RFCA8828TR13	13" Reel with 2500 pieces
RFCA8828PCK-410	50MHz to 1200MHz PCBA with 5-piece sample bag

Absolute Maximum Ratings

Parameter	Rating	Unit
Max Device Current (I _D)	500	mA
Max Device Voltage (V _D)	7	V
Max RF Input Power	32	dBm
Max Channel Temperature (T _C)	160	°C
Storage Temperature	-40 to +85	°C



Caution! ESD sensitive device.



RFMD Green: RoHS status based on EU Directive 2011/65/EU (at time of this document revision), halogen free per IEC 61249-2-21, < 1000ppm each of antimony trioxide in polymeric materials and red phosphorus as a flame retardant, and <2% antimony in solder.

Exceeding any one or a combination of the Absolute Maximum Rating conditions may cause permanent damage to the device. Extended application of Absolute Maximum Rating conditions to the device may reduce device reliability. Specified typical performance or functional operation of the device under Absolute Maximum Rating conditions is not implied.

Recommended Operating Condition

Parameter	Specification			Unit
	Min	Typ	Max	
Operating Temperature Range	-40		+85	°C
Operating Junction Temperature			160	°C
Supply Voltage Range ^{1, 2}	5.7	6	6.3	V
Supply Voltage Range ²	4.75	5	5.25	V

Notes:

- Operation of this device beyond any one of these limits may cause permanent damage. For reliable continuous operation, the device voltage and current must not exceed the maximum operating values specified in the Absolute Maximum Ratings Table above.
- Bias conditions should also satisfy the following expression: $I_D V_D < (T_C - T_L) / R_{TH, j-I}$ and $T_L = T_{LEAD}$

Nominal Operating Parameters

Parameter	Specification			Unit	Condition
	Min	Typ	Max		
V_{DD} = 6V, I_{DD} = 360mA, Temp = 25°C					
Frequency Range	50		1200	MHz	
Small Signal Gain		16.3		dB	50MHz
		16.4		dB	500MHz
		16.4		dB	1000MHz
		16.4		dB	1200MHz
Gain Flatness		+/-1		dB	50MHz to 1200MHz
Output IP3		44		dBm	500MHz, Tone spacing = 6MHz, P _{OUT} per tone = +7dBm
Output IP2 Plus		79		dBm	500MHz, Tone spacing = 30MHz, P _{OUT} per tone = +3dBm
Output IP2 Minus		85		dBm	
P1dB		27		dBm	500MHz

Parameter	Specification			Unit	Condition
	Min	Typ	Max		
Input Return Loss		-18		dB	500MHz
Output Return Loss		-21		dB	
Noise Figure (Balun Insertion Loss Included)		2.75		dB	50MHz to 1200MHz
CSO		93		dBc	79 Channel, Flat Tilt, +34dBmV
CTB		85		dBc	
XMOD		76		dBc	
Device Operating Voltage		6.0		V	
Device Operating Current		360		mA	
Thermal Resistance		32		°C/W	Junction to backside PCB
V_{DD} = 5V, I_{DD} = 293mA, Temp = 25°C					
Frequency Range	50		1200	MHz	
Small Signal Gain		16.4		dB	50MHz
		16.4		dB	500MHz
		16.4		dB	1000MHz
		16.3		dB	1200MHz
Gain Flatness		+/-1		dB	50MHz to 1200MHz
Output IP3		42		dBm	500MHz, Tone spacing = 6MHz, P _{OUT} per tone = +7dBm
Output IP2 Plus		72		dBm	500MHz, Tone spacing = 30MHz, P _{OUT} per tone = +3dBm
Output IP2 Minus		80		dBm	
P1dB		25		dBm	
Input Return Loss		-19		dB	500MHz
Output Return Loss		-21		dB	
Noise Figure (Balun Insertion Loss Included)		2.75		dB	50MHz to 1200MHz
CSO		85		dBc	79 Channel, flat tilt, +34dBmV
CTB		81		dBc	
XMOD		73		dBc	
Device Operating Voltage		5.0		V	
Device Operating Current		293		mA	
Thermal Resistance		30		°C/W	Junction to backside PCB

Typical Application Schematic 50MHz to 1200MHz

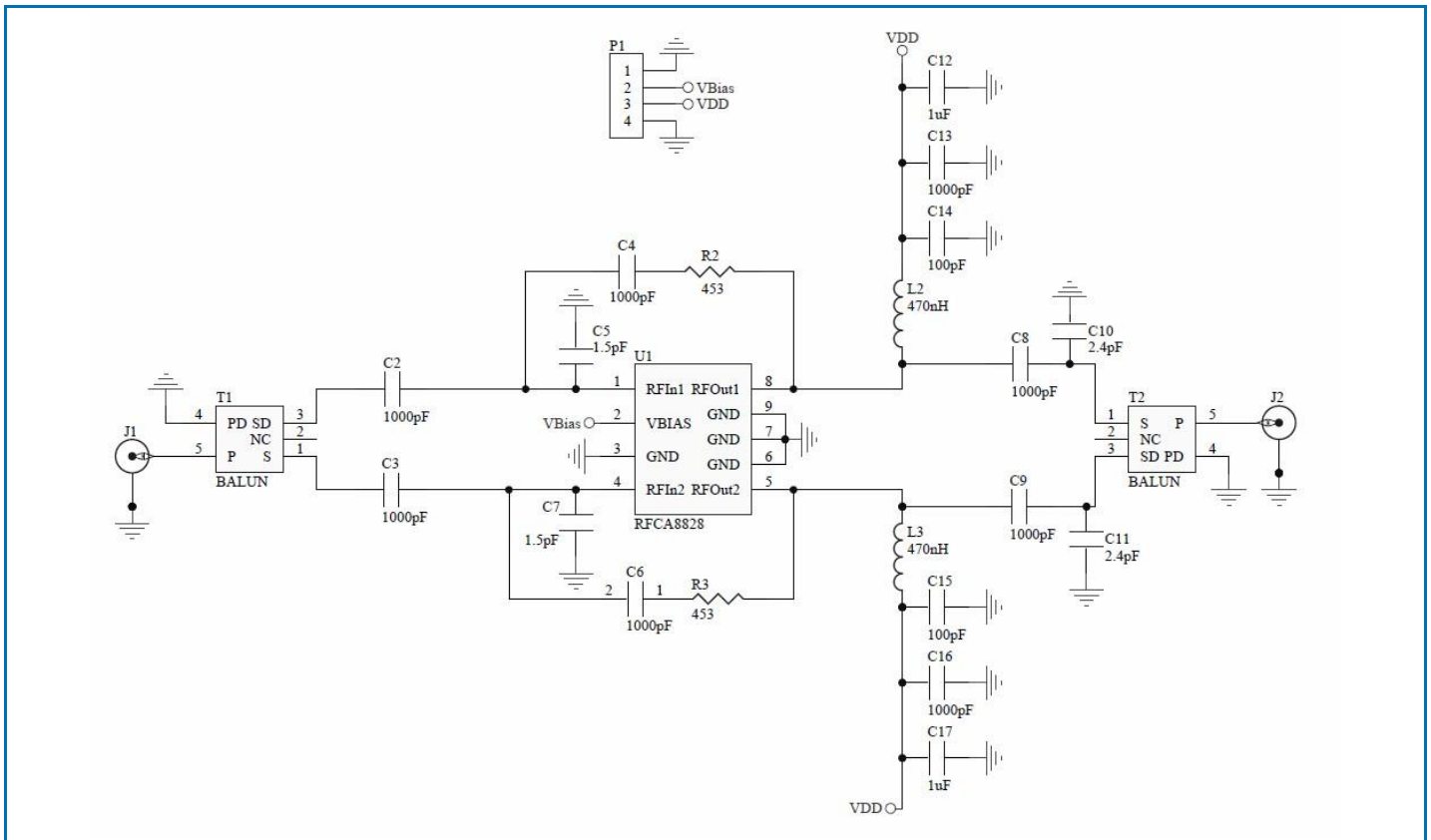

Typical Performance: $V_{DD} = 6V$, $I_{DD} = 360mA$, Temp = 25°C

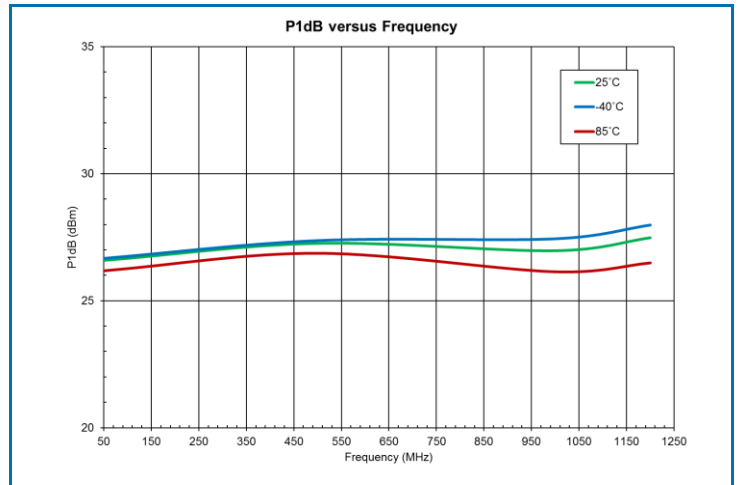
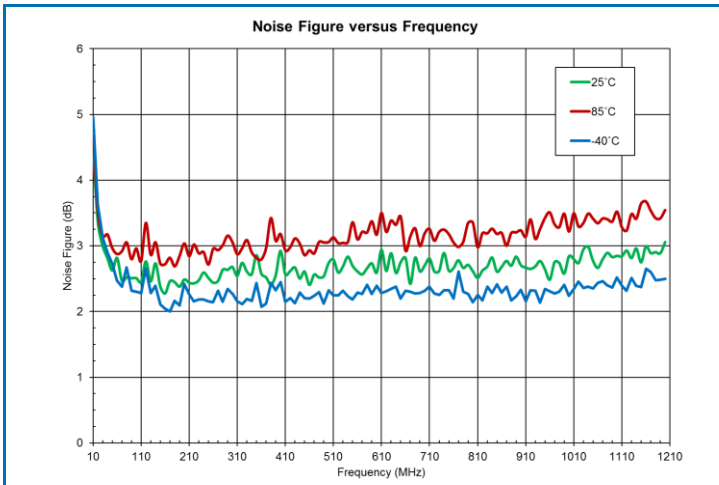
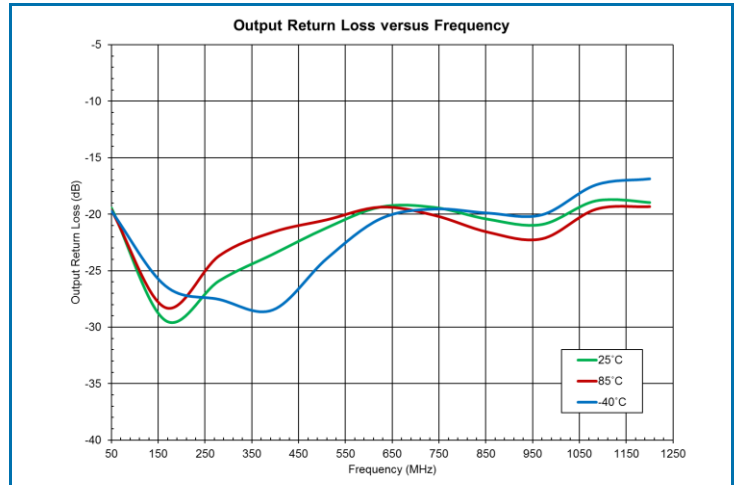
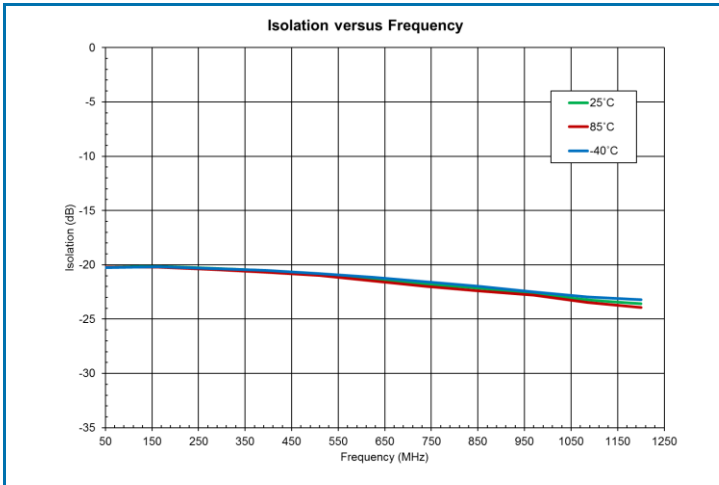
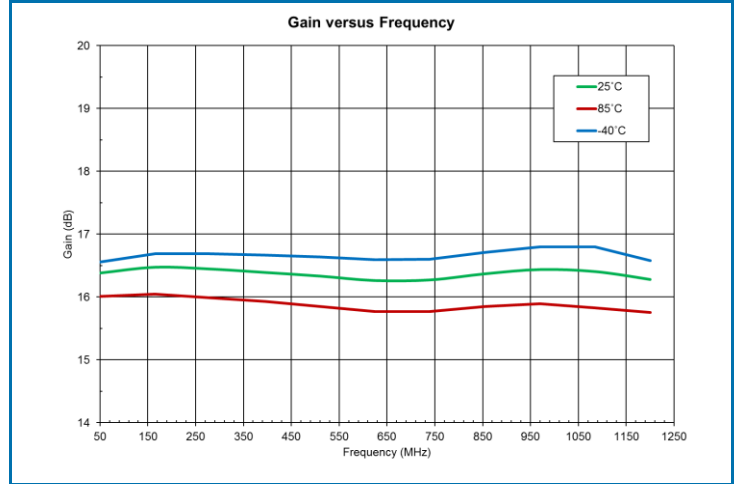
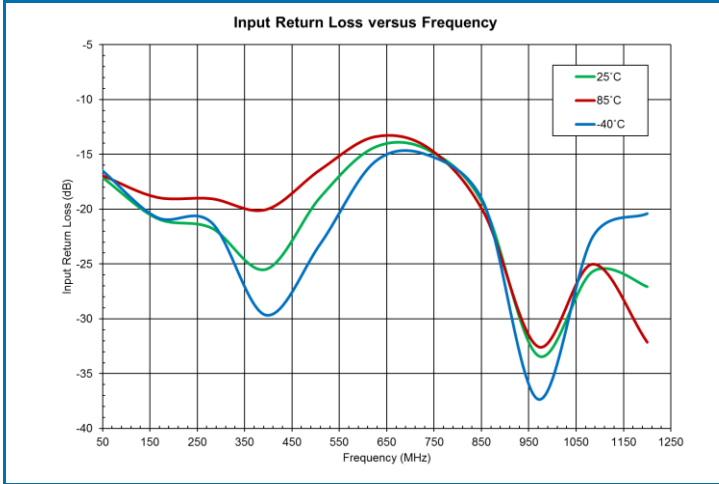

Typical Performance: $V_{DD} = 6V$, $I_{DD} = 360mA$, Temp = $25^{\circ}C$

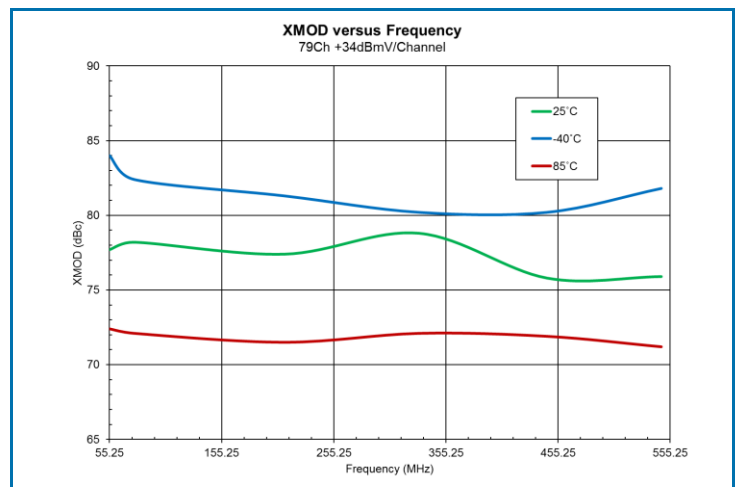
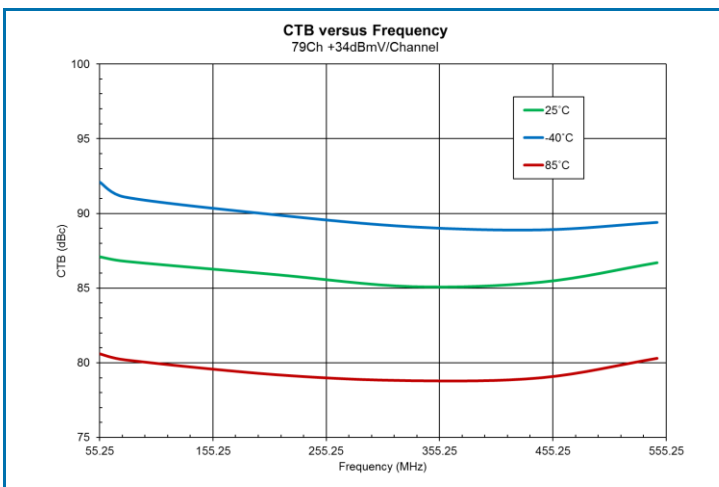
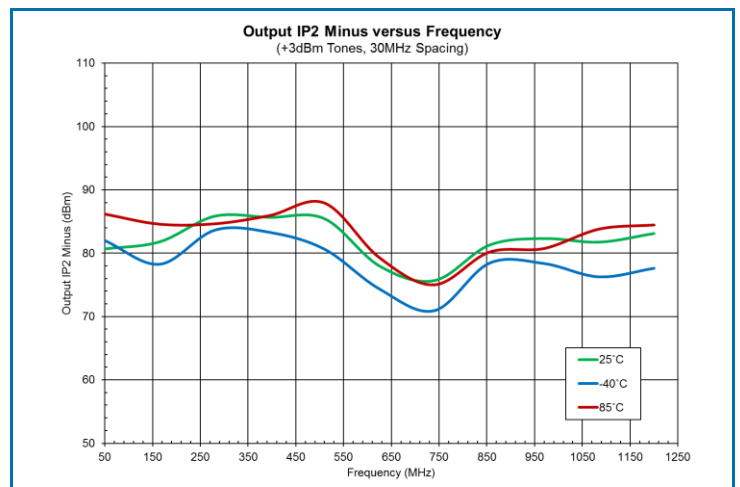
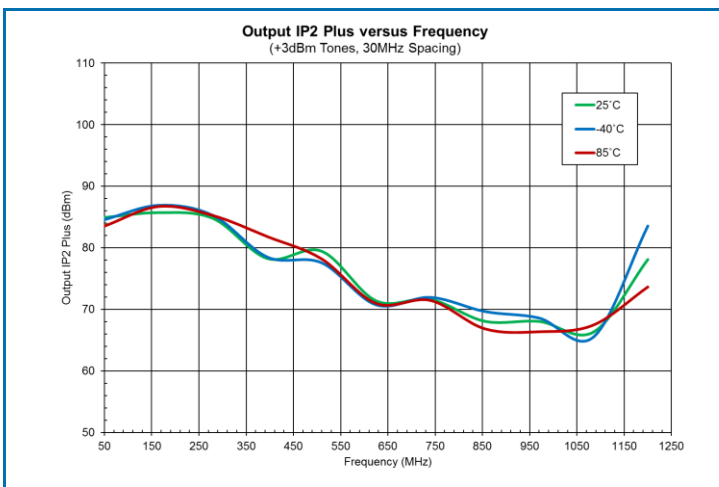
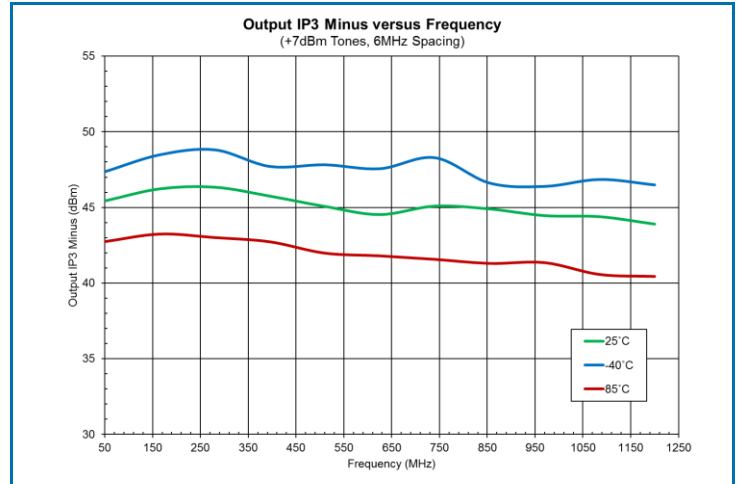
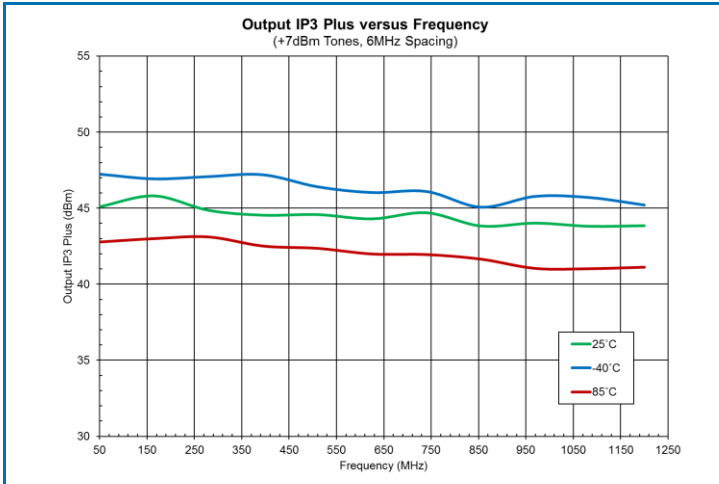

Typical Performance: $V_{DD} = 6V$, $I_{DD} = 360mA$, Temp = $25^{\circ}C$

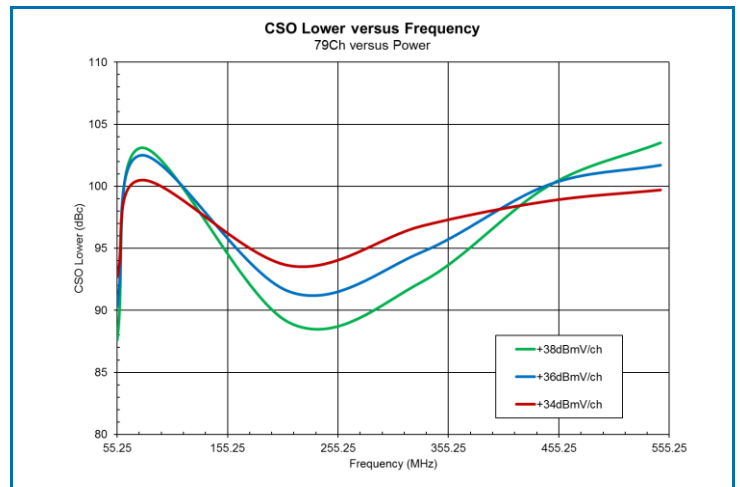
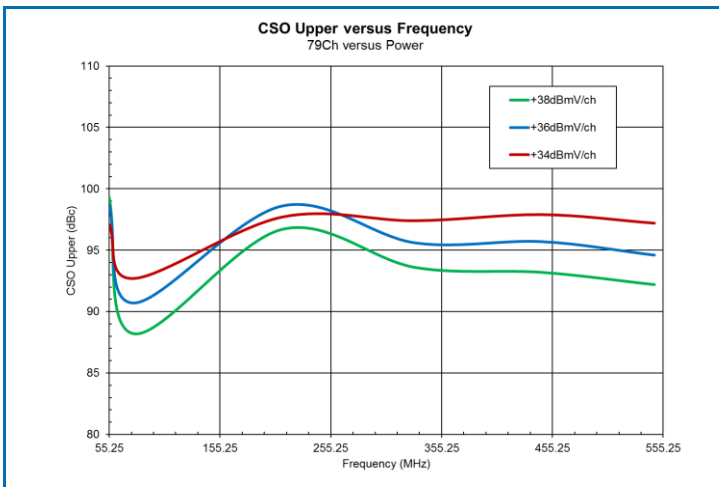
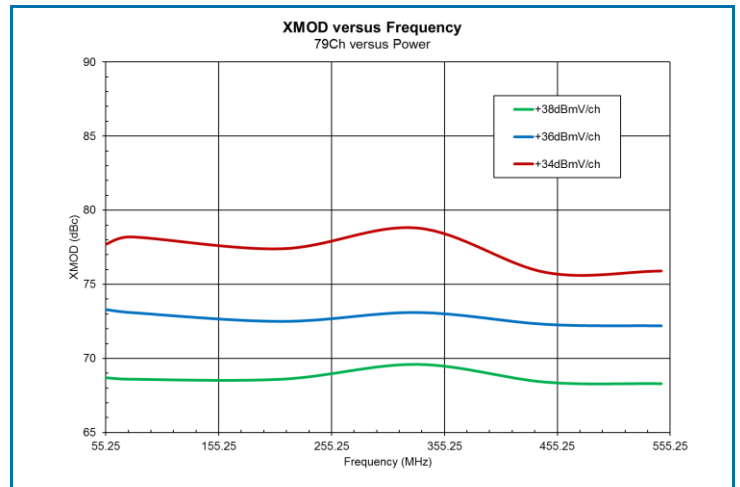
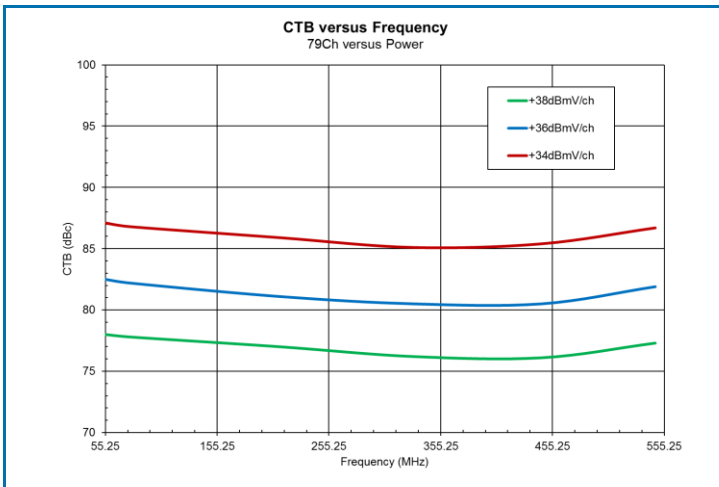
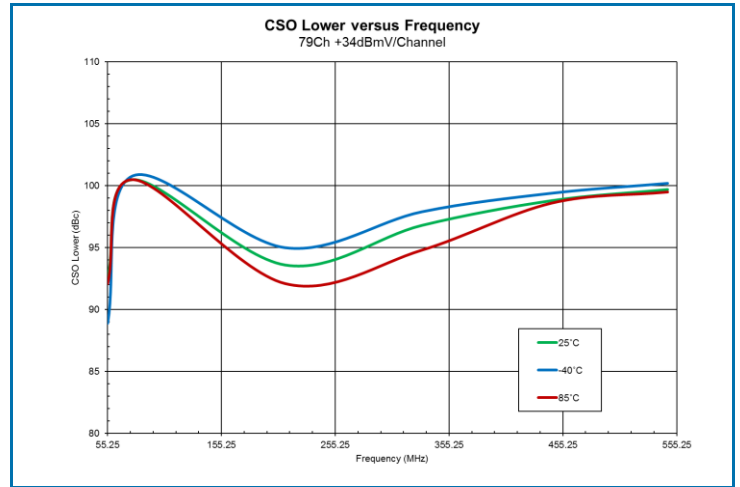
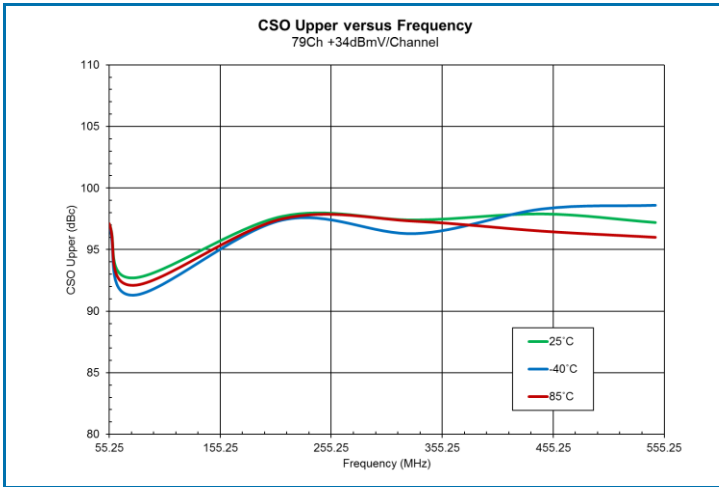

Typical Performance: $V_{DD} = 5V$, $I_{DD} = 293mA$, Temp = 25°C

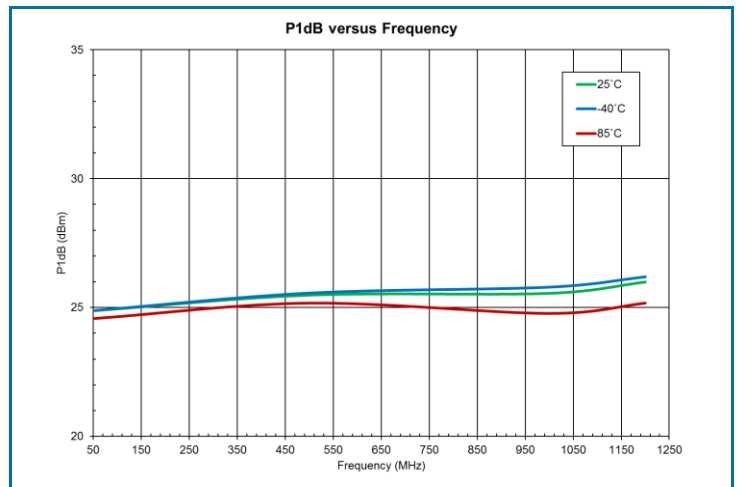
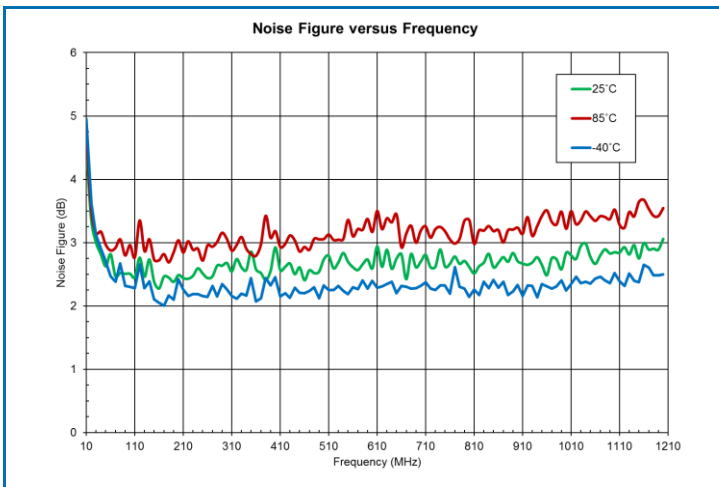
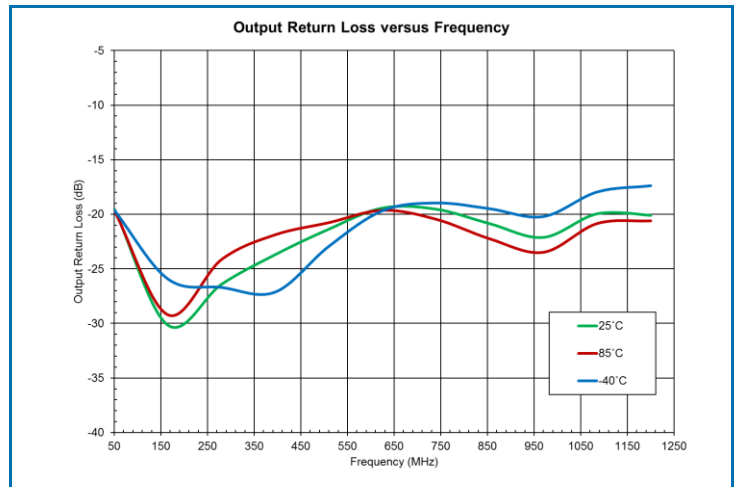
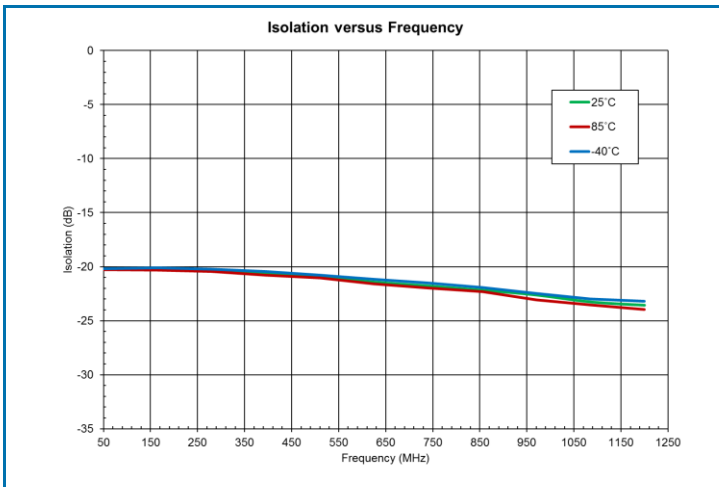
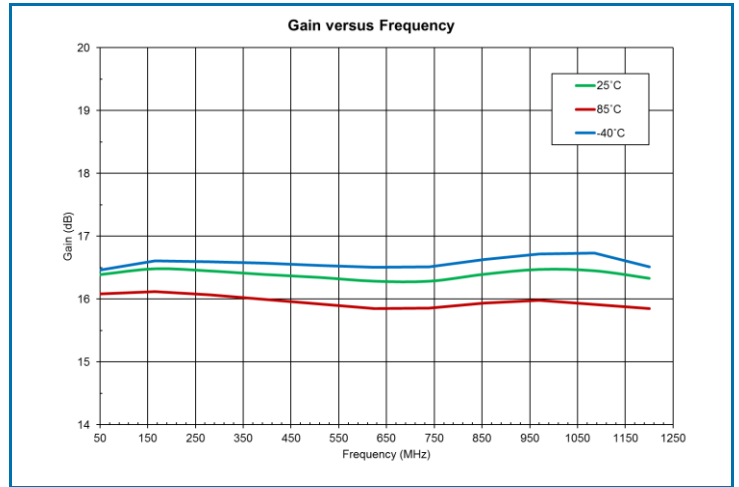
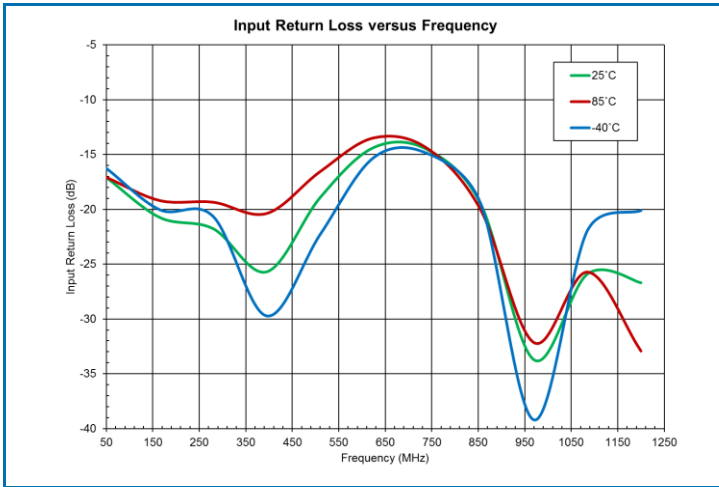

Typical Performance: $V_{DD} = 5V$, $I_{DD} = 293mA$, Temp = 25°C

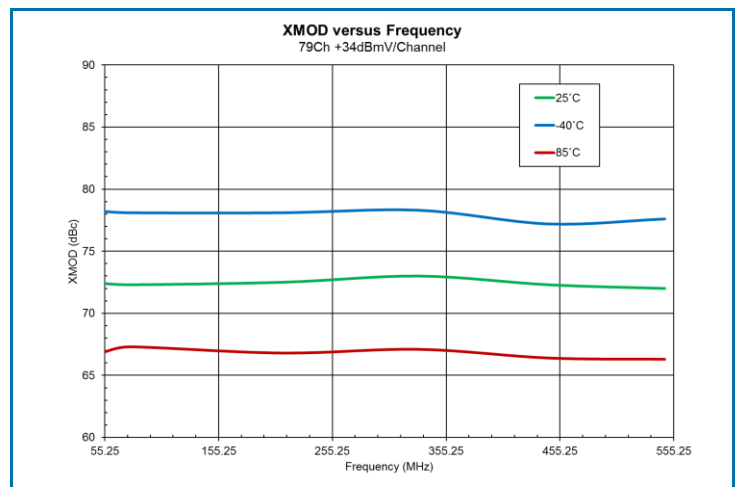
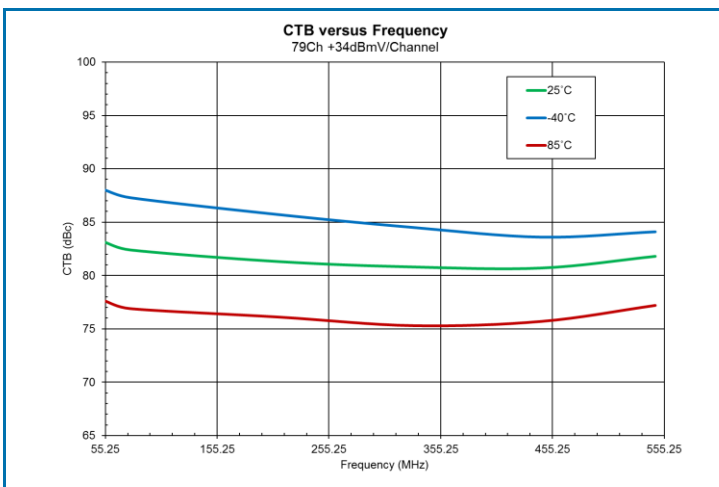
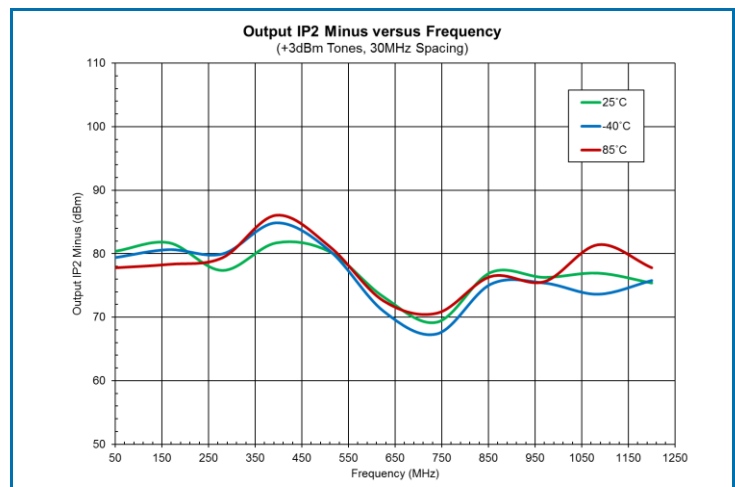
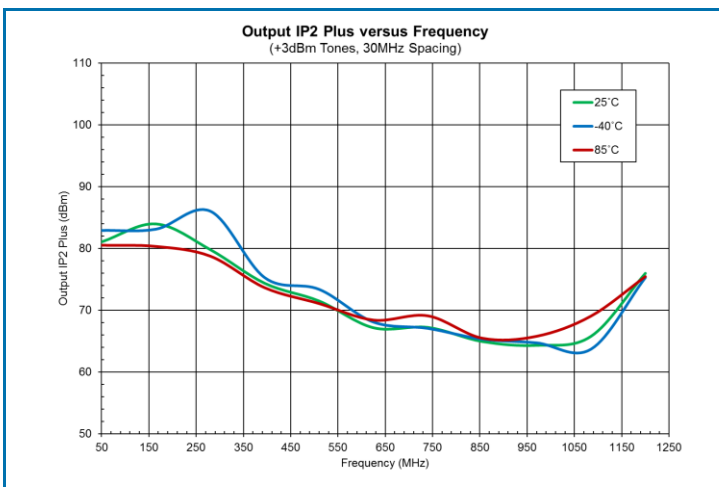
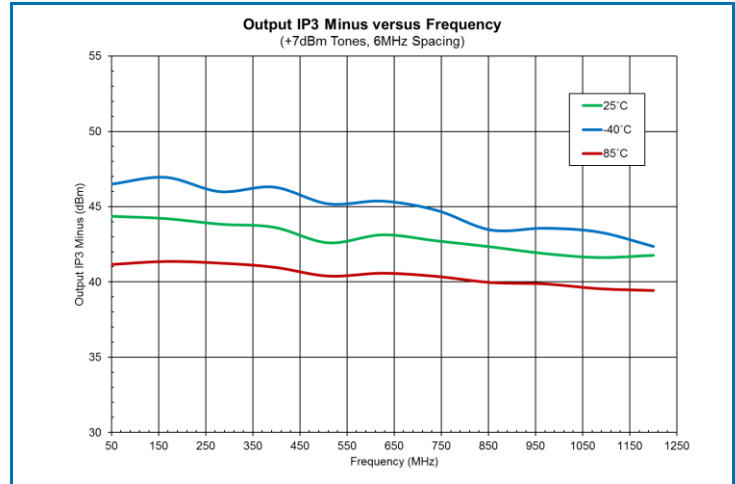
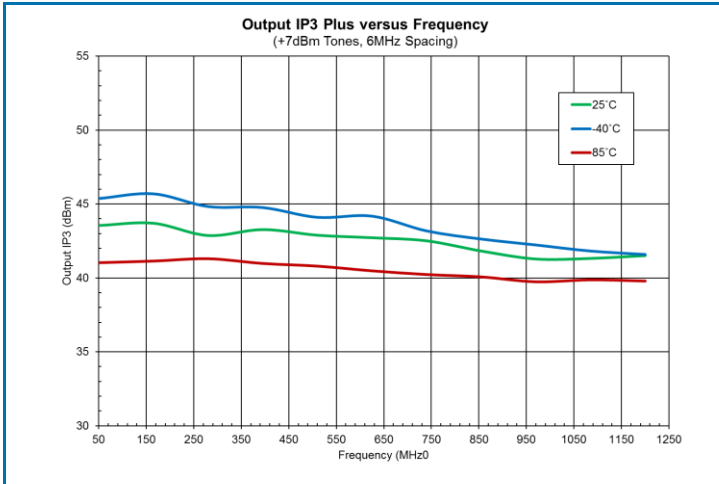

Typical Performance: $V_{DD} = 5V$, $I_{DD} = 293mA$, Temp = 25°C

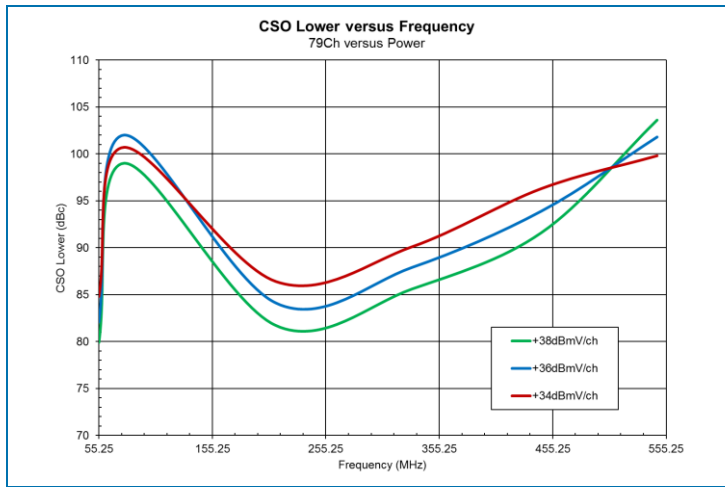
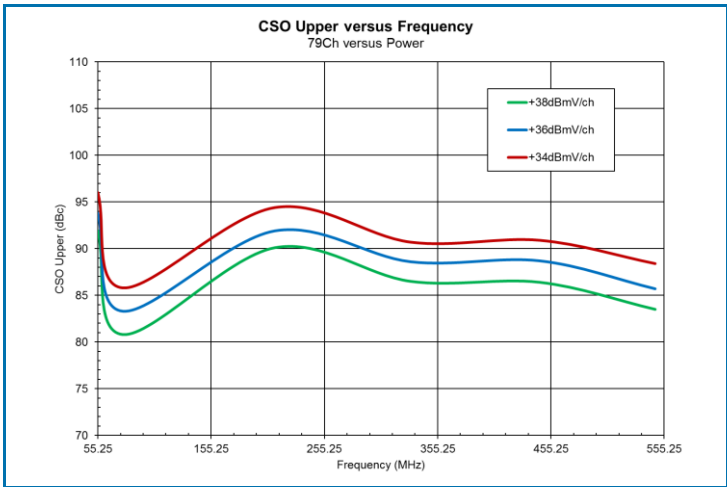
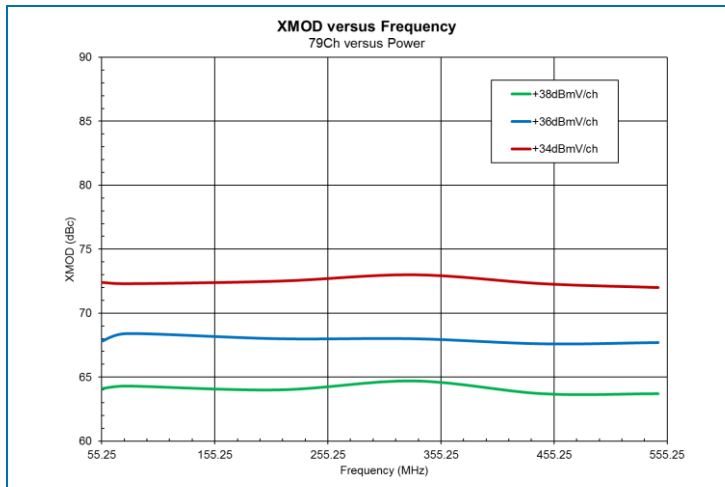
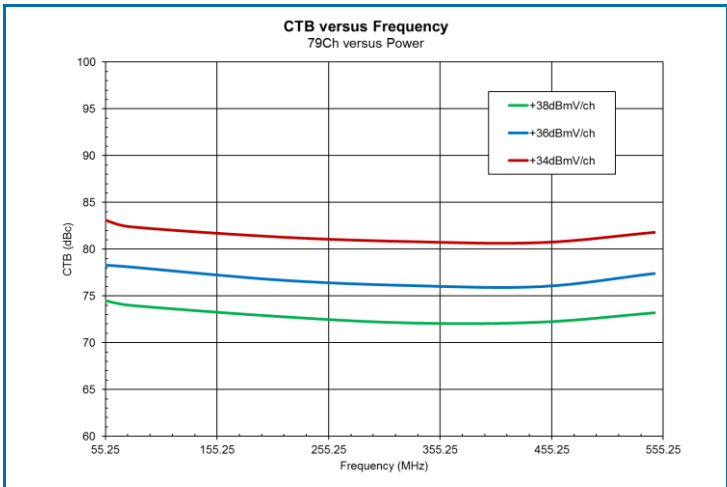
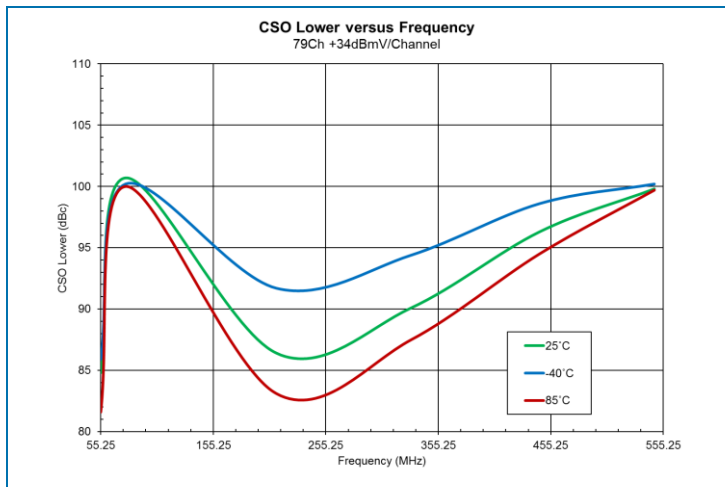
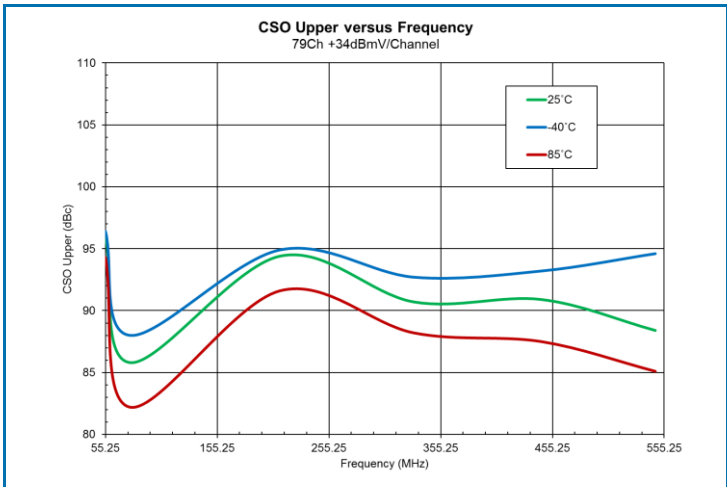

Evaluation Board Schematic 50MHz to 1200MHz Application Circuit

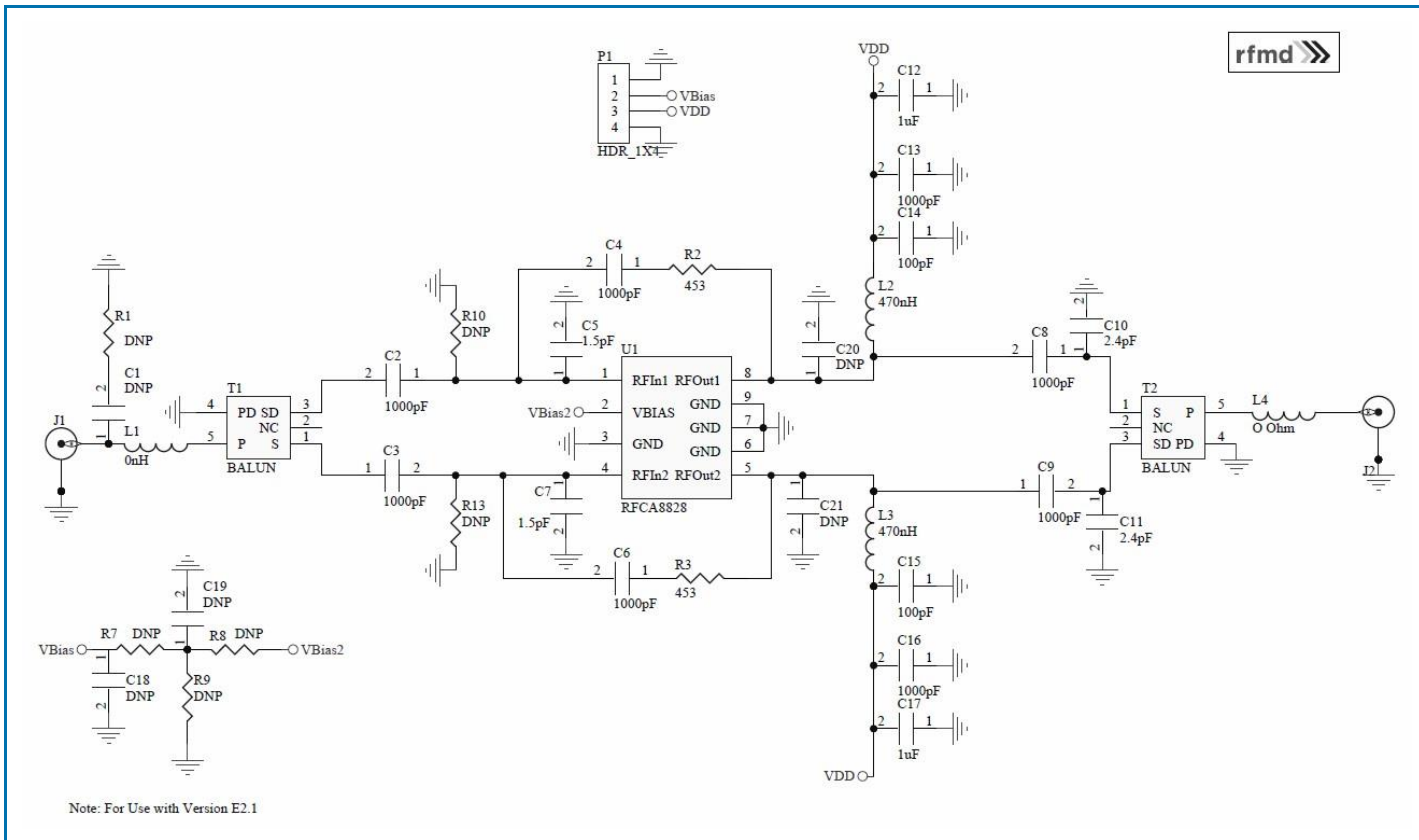

Evaluation Board Bill of Materials (BOM) 50MHz to 1200MHz Application Circuit

Description	Reference Designator	Manufacturer	Manufacturer's P/N
RFCA8828 Evaluation Board		Performance Micro International Pt.	RFCA8828-410(B)
Balanced PHEMT CATV Amp	U1		RFCA8828
CAP, 1000pF, 5%, 50V, COG, 0603	C2-C3, C8-C9, C13, C16	Murata Electronics	GRM1885C1H102JA01
CAP, 1000pF, 5%, 50V, COG, 0402	C4, C6	Murata Electronics	GRM1555C1H102JA01D
CAP, 1.5pF, +/-0.25pF, 50V, HI-Q, 0402	C5, C7	Murata Electronics	GJM1555C1H1R5CB01D
CAP, 2.4pF, +/-0.1pF, 250V, HI-Q, 0603	C10-C11	American Technical Ceramics	600S2R4BT250XT
CAP, 1 μ , 10%, 16V, X7R, 0603	C12, C17	Murata Electronics	GRM188R71C105KA12D
CAP, 100pF, 5%, 50V, COG, 0603	C14-C15	Murata Electronics	GRM1885C1H101JA01D
RES, 0 Ω , 0402 KAMAYA	L1, L4	Kamaya, Inc.	RMC1/16SJPTH
IND, 470nH, 5%, W/W, 0805	L2-L3	Coilcraft, Inc.	0805LS-471XJLC
RES, 453 Ω , 1%, 1/10W, 0402	R2-R3	Panasonic Industrial Devices	ERJ-2RKF4530X
BALUN, 1:1, 4.5MHz to 3000MHz, 75 Ω , SMD	T1-T2	M/A-COM Technology Solutions	MABACT0059
CONN, HDR, St, 4-PIN, 0.100	P1	Samtec Inc.	TSW-104-08-S-S
CONN, F FEM EDGE MOUNT, 75 Ω , 0.068"	J1-J2	Millimeter Wave, LLC	MW-846-C-DD-75
HEATSINK BLOCK, 1.5 x 2.0 IN			
SCREW, 2-56 x 3/16", SOCKET HEAD	S1-S4	McMaster-Carr Supply Co.	92196A076
DNP	C1, C18-C21, R1, R7-R10, R13		

Evaluation Board Assembly Drawing 50MHz to 1200MHz Application Circuit

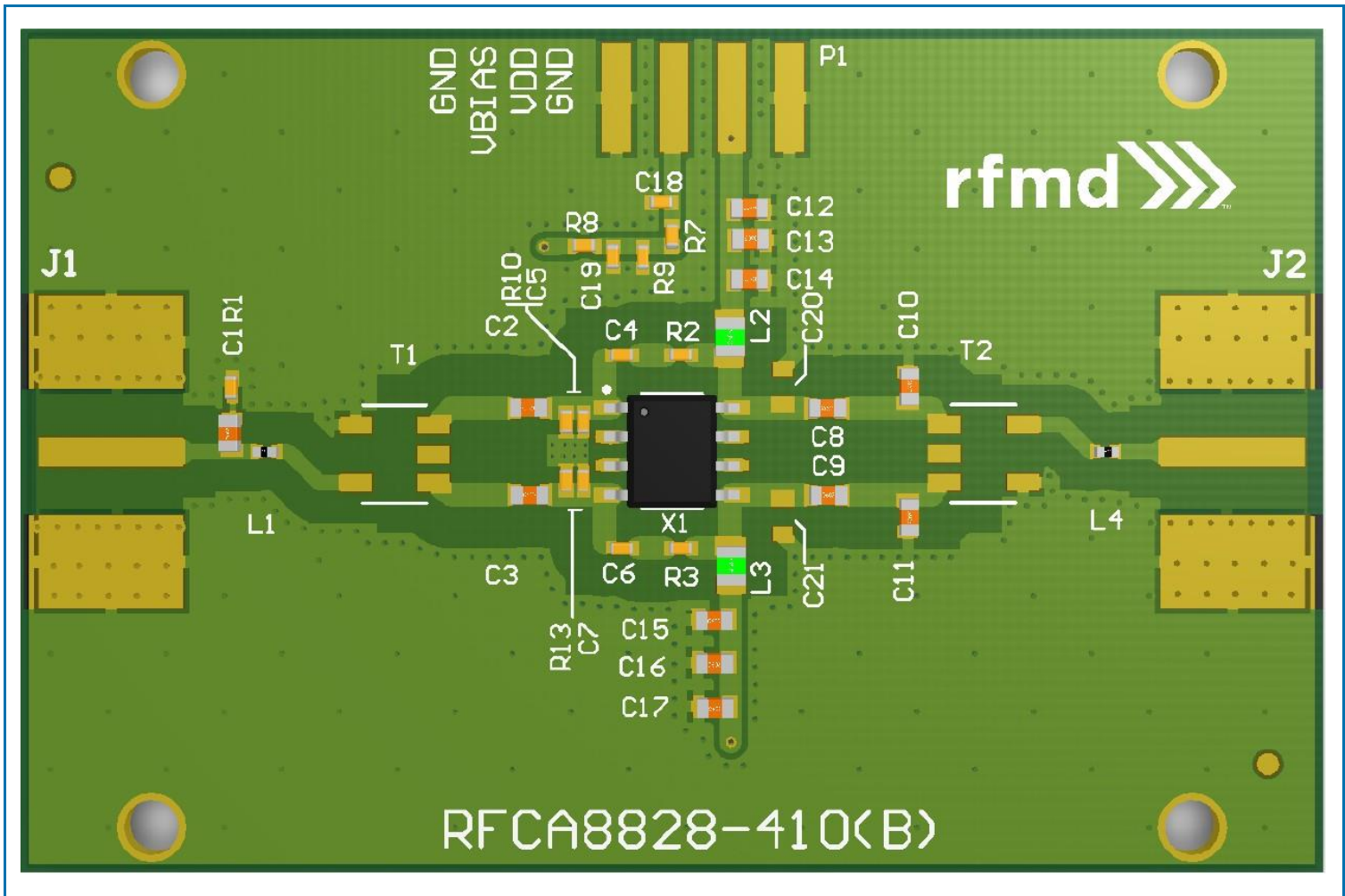

Pin Names and Descriptions

Pin	Name	Description
1	RFIN1	RF input pin. External DC blocking capacitor is required
2	VBIAS	Current adjust / NC in the application circuit
3	GND	Connection to ground. Use via holes for best performance to reduce lead inductance as close to ground leads as possible
4	RFIN2	RF input pin. External DC blocking capacitor is required
5	RFOUT2/VCC	RF output and bias pin (open drain)
6	GND	Connection to ground. Use via holes for best performance to reduce lead inductance as close to ground leads as possible
7	GND	Connection to ground. Use via holes for best performance to reduce lead inductance as close to ground leads as possible
8	RFOUT1/VCC	RF output and bias pin (open drain)
EPAD	GND	Exposed area on the bottom side of the package must be soldered to the ground plane of the board for optimum thermal and RF performance. Several vias should be located under the EPAD as shown in the recommended land pattern.

Package Outline Drawing (Dimensions in inches)

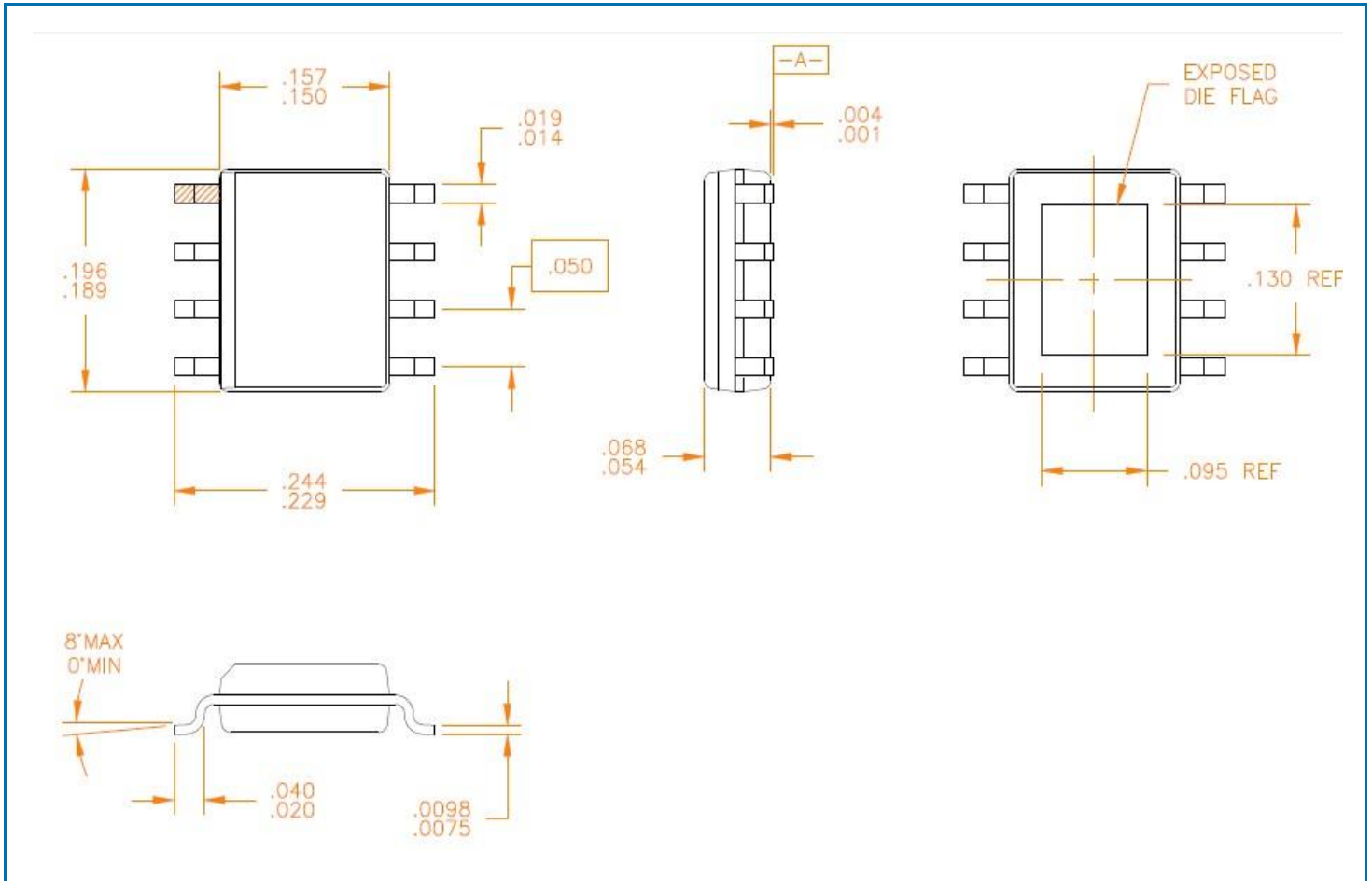

Branding Diagram

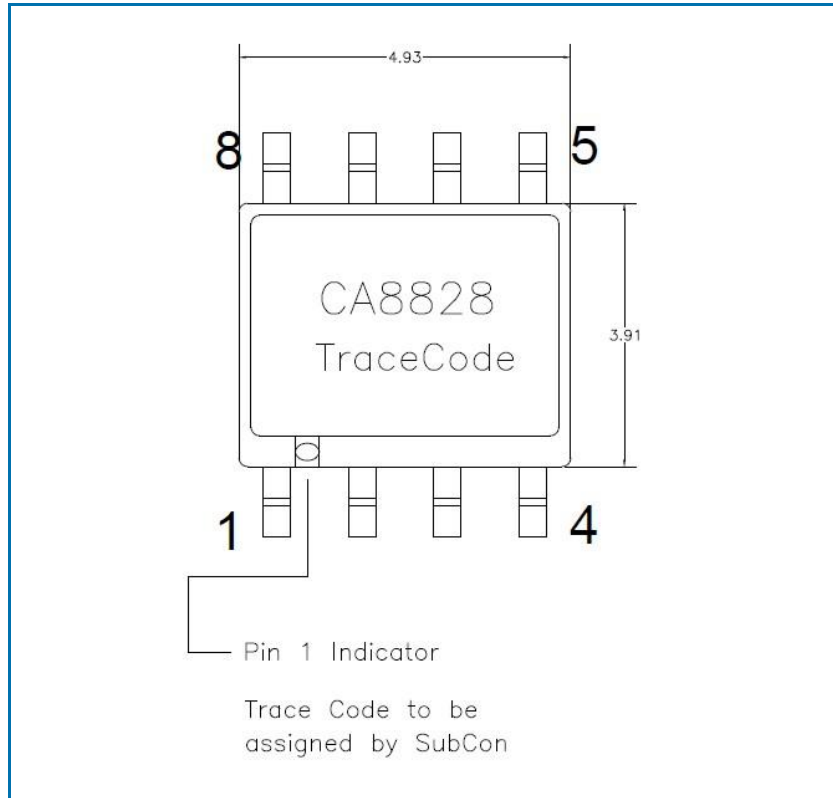

Looking for pricing, stock, or lifecycle information?

Click below to explore more details on WIN SOURCE:

 [View RFCA8828SR on WIN SOURCE](#)

 [Qorvo US Inc. Information](#)

Optimize Your Supply Chain with WIN SOURCE Solutions

-  Global Sourcing Solution
-  Obsolete Management
-  Cost Control Management
-  Shortage Management
-  Alternative Solution
-  Excess Inventory Management