

Product Overview

The QPA9909 is a high-efficiency, linearizable power amplifier targeting 758 MHz – 798 MHz small-cell wireless infrastructure systems. The product delivers high efficiency of 37.7 % at +29dBm average output power, while providing excellent DPD linearized ACPR of -52 dBc for signal bandwidths of up to 40 MHz.

The QPA9909 is housed in a 5x5mm SMT package. It is pin-to-pin compatible to QPA9901, QPA9903, QPA9907, QPA9908, QAP9940 and QPA9942.



16 Pad 5 x 5 mm Package

Key Features

- 758 – 798 MHz
- 31 dB gain
- Over 36.5 dBm P3dB
- 37.7 % PAE at +29 dBm power output
- <-52 dBc ACPR DPD linearized at +29 dBm power output with 2-carrier signal
- 1.8V logic compatible PA ON/OFF control
- On chip ESD protection
- 5 x 5 mm Package

Functional Block Diagram

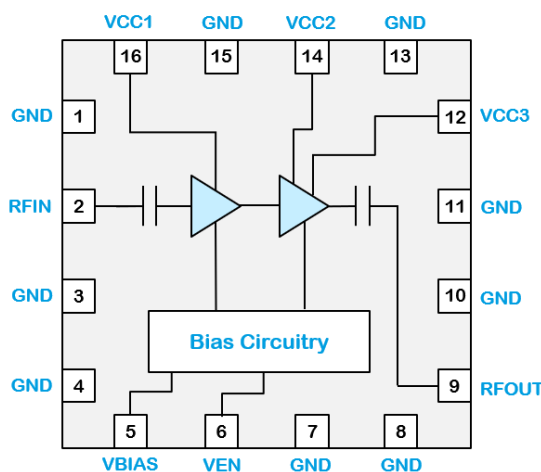

Top View

Applications

- 4G/5G Small-cell BTS
- 5G M-MIMO
- Repeaters / DAS
- Mobile Infrastructure
- General Purpose Wireless

Ordering Information

| Part No. | Description |
|---------------|---------------------|
| QPA9909TR13 | 2500pcs on 13" reel |
| QPA9909EVB-01 | 758-798 MHz EVB |

Absolute Maximum Ratings

| Parameter | Rating |
|--|---------------|
| Storage Temperature | -55 to +125°C |
| RF Input Power, Pulsed CW, 50 Ω ⁽¹⁾ | +10 dBm |
| Device Voltage (V _{CC}) | +5.5 V |

Exceeding any one or a combination of the Absolute Maximum Rating conditions may cause permanent damage to the device. Extended application of Absolute Maximum Rating conditions to the device may reduce device reliability.

Note:

1. 758-798 MHz, Pulsed CW, 10% duty cycle, 100us period

Recommended Operating Conditions

| Parameter | Min | Typ | Max | Units |
|--|-------|-----|-------|-------|
| Device Voltage (V _{CC}) | +4.75 | +5 | +5.25 | V |
| T _{CASE} | -40 | | +105 | °C |
| T _j for >10 ⁶ hours MTTF | | | +175 | °C |

Electrical specifications are measured at specified test conditions. Specifications are not guaranteed over all recommended operating conditions.

Electrical Specifications

| Parameter | Conditions ⁽¹⁾ | Min | Typ | Max | Units |
|---------------------------------------|---|------|-------|-----------------|-------|
| Operational Frequency Range | | 758 | | 798 | MHz |
| Test Frequency | | | 778 | | MHz |
| Gain ⁽²⁾ | At +29 dBm P _{out} and room temperature | 29.3 | 31.1 | | dB |
| Input Return Loss | | | 18 | | dB |
| Output Return Loss | | | 2.8 | | dB |
| Output P _{3dB} | 10 μs pulse width, 10% duty cycle | 35.5 | +36.6 | | dBm |
| Power Added Efficiency ⁽²⁾ | P _{out} = +29 dBm | | 37.7 | | % |
| ACPR (Uncorrected) ⁽²⁾ | P _{out} = +29 dBm | | -28.6 | -27.5 | dBc |
| ACPR with DPD ⁽²⁾ | P _{out} = +29 dBm | | -54.7 | | dBc |
| ACPR with DPD ⁽³⁾ | P _{out} = +29 dBm | | -52.5 | | dBc |
| Quiescent Current, I _{CCQ} | Pins 5, 12, 14 and 16 | | 89.1 | | mA |
| Total Operating Current | Pins 5, 12, 14 and 16, P _{out} = +29 dBm | | 423.5 | | mA |
| Thermal Resistance, θ _{Jc} | Junction to case | | 24.4 | | °C/W |
| V _{EN} High | | 1.17 | 1.8 | V _{CC} | V |
| V _{EN} Low | | 0 | 0 | 0.63 | V |
| 2nd Harmonic | P _{out} = +29 dBm | | -38.4 | | dBc |
| 3rd Harmonic | P _{out} = +29 dBm | | -49.8 | | dBc |

Notes:

1. Test conditions unless otherwise noted: All V_{CC} & V_{BIAS} = +5.0V, V_{EN} = +1.8V, Temp = +25 °C, 50 Ω system.
2. LTE, 20 MHz E-UTRA Test Mode 1.1 or 3.1, PAR = 8.5 dB at 0.01% probability.
3. LTE, 2 x 20 MHz E-UTRA Test Mode 1.1 or 3.1, PAR = 8.0 dB at 0.01% probability.

Power Amplifier Enable Logic Table

| Parameter | High | Low |
|-----------------|--------------------|---------------------|
| V _{EN} | Power Amplifier ON | Power Amplifier OFF |

758 – 798 MHz Evaluation Board

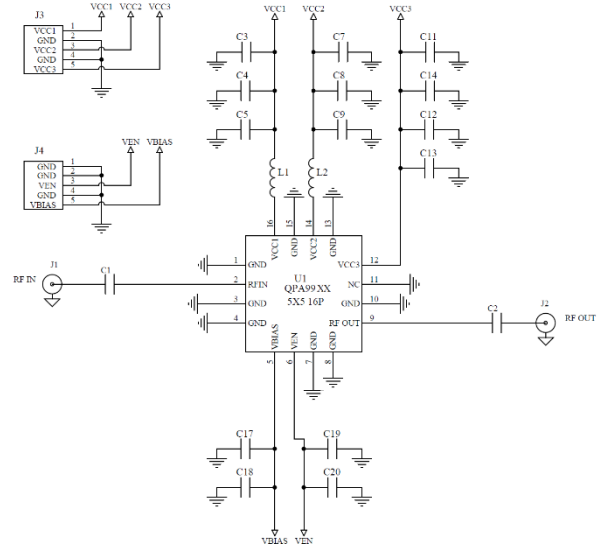
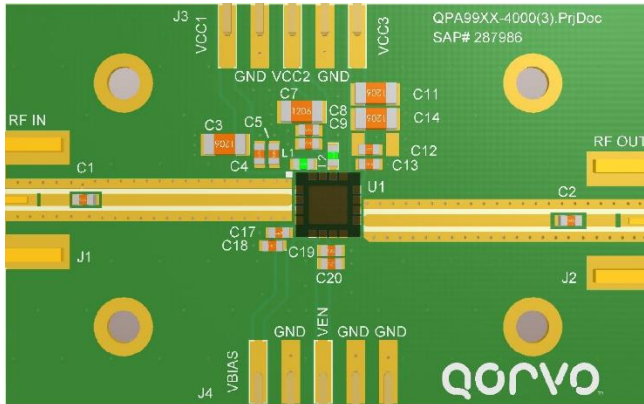

- Notes:
1. See Evaluation Board PCB Information for material and stack up.

Bill of Material – QPA9909EVB-01

| Reference Des. | Value | Description | Manuf. | Part Number |
|-----------------------|---------|---|---------|-------------|
| U1 | - | Amplifier, QPA9909 758-798 MHz, High-Efficiency | Qorvo | QPA9909 |
| C1, C2 | 100 pF | CAP,100 pF, 0603, 5%, 50V, C0G | various | |
| C5, C9, C13, C17, C19 | 1000 pF | CAP,1000 pF, 0603, 5%, 50V, C0G | various | |
| C4, C8, C12, C18, C20 | 0.1 μF | CAP,0.1 μF, 0603, 10%, 50V, X7R | various | |
| C3, C7, C14 | 10 μF | CAP, 10 μF, 1206, 25V | various | |
| L1, L2 | 0 Ω | RES 0 Ω, 0603, 1/16W, Chip | various | |
| J1, J2 | - | CONN. RF. SMA. F. STRT. Edge Mount | various | |
| J3, J4 | - | Connector, 5 Pin | various | |

Performance Plots - LTE

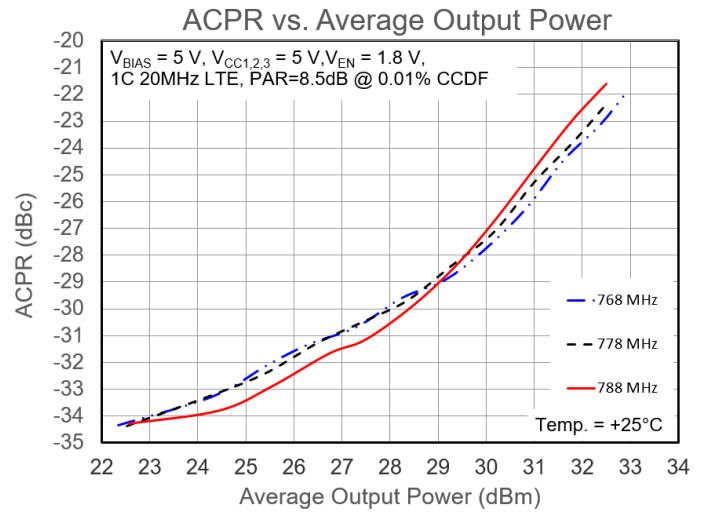
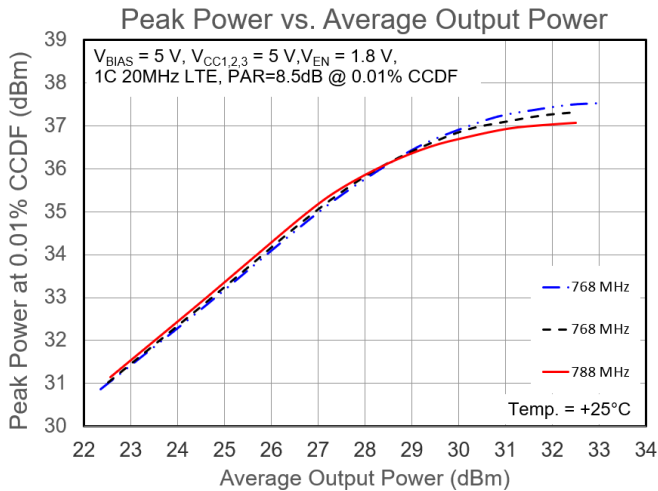
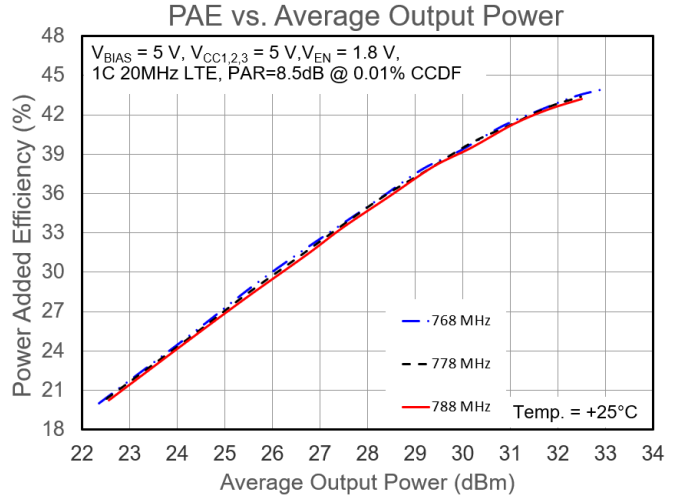
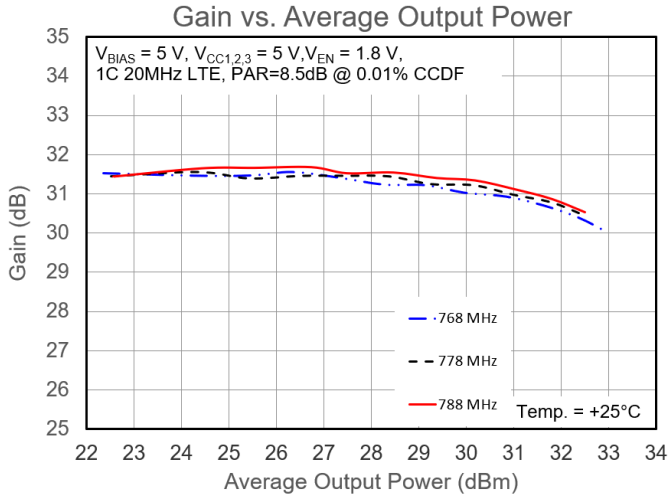

Test conditions unless otherwise noted: $V_{BIAS} = 5\text{ V}, V_{CC1,2,3} = 5\text{ V}, V_{EN} = 1.8\text{ V}, T = +25^\circ\text{C}$, tested using a single-carrier, 20 MHz LTE signal with 8.5 dB PAR at 0.01% CCDF on a reference design fixture.

Performance Plots - LTE

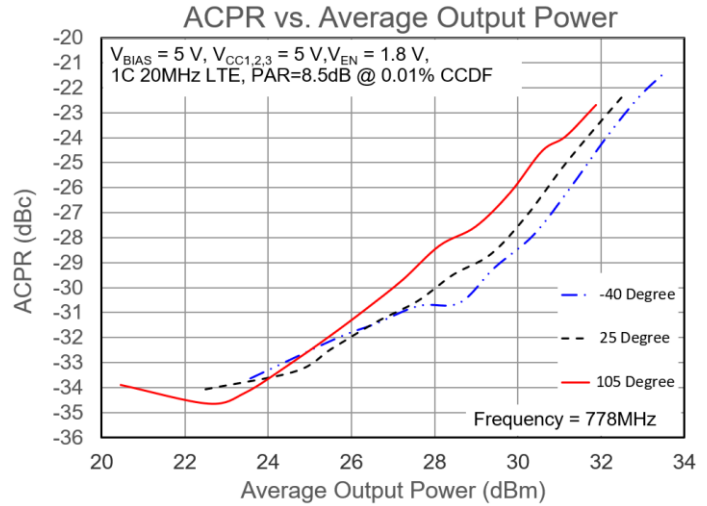
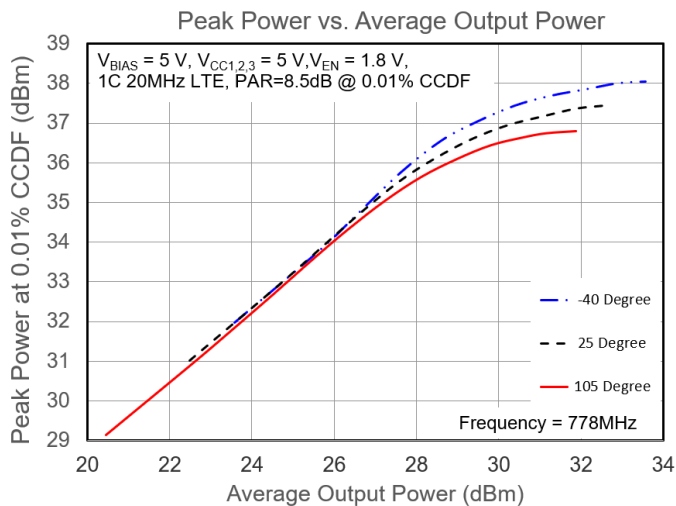
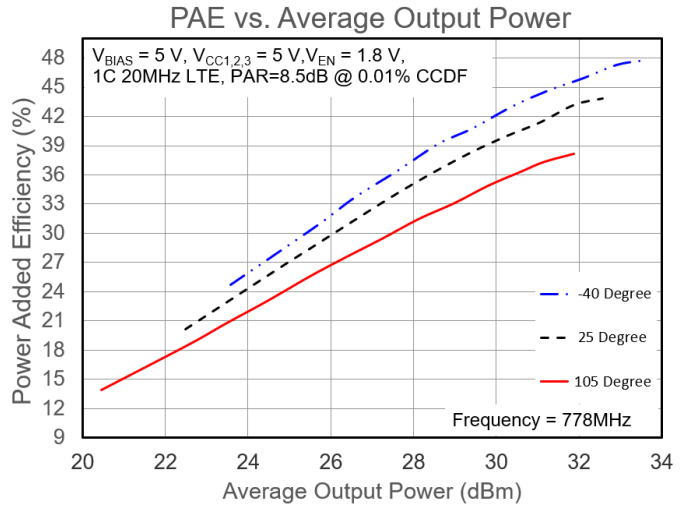
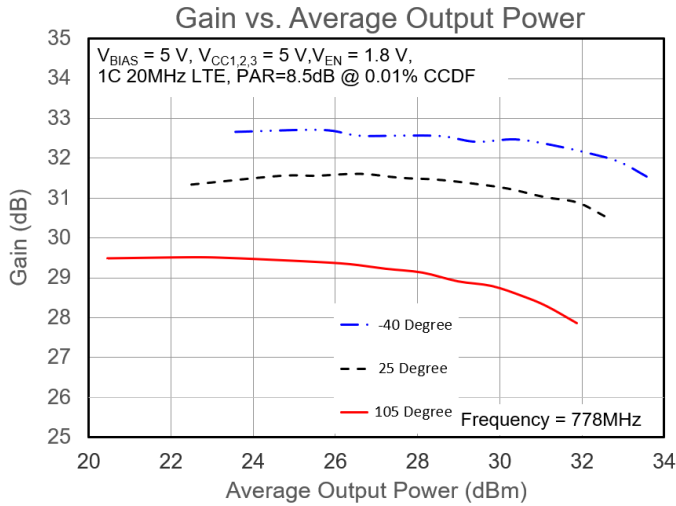

Test conditions unless otherwise noted: $V_{BIAS} = 5\text{ V}, V_{CC1,2,3} = 5\text{ V}, V_{EN} = 1.8\text{ V}$, tested at 778 MHz using a single-carrier, 20 MHz LTE signal with 8.5 dB PAR at 0.01% CCDF on a reference design fixture.

Performance Plots - Pulse

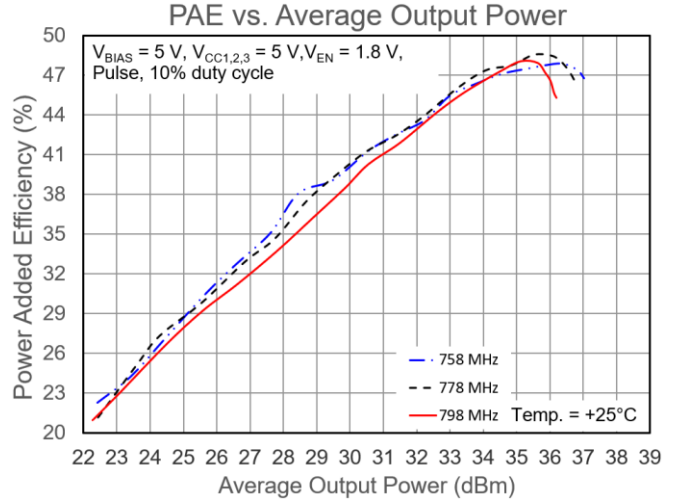
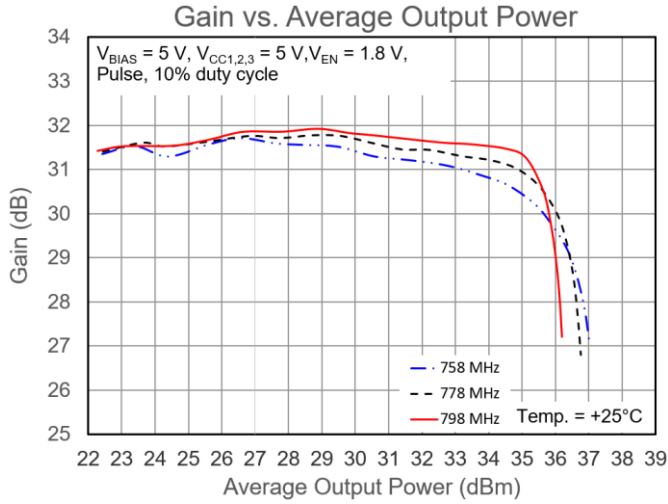

Test conditions unless otherwise noted: $V_{BIAS} = 5V$, $V_{CC1,2,3} = 5V$, $V_{EN} = 1.8V$, $T = +25^{\circ}C$, tested using a pulse signal, 10% duty cycle.

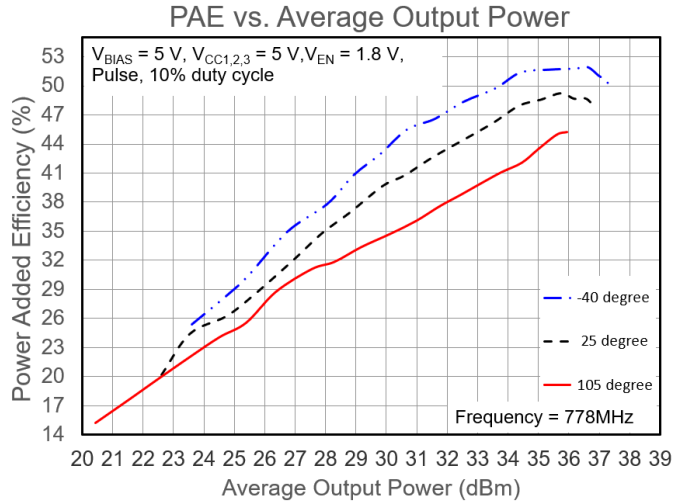
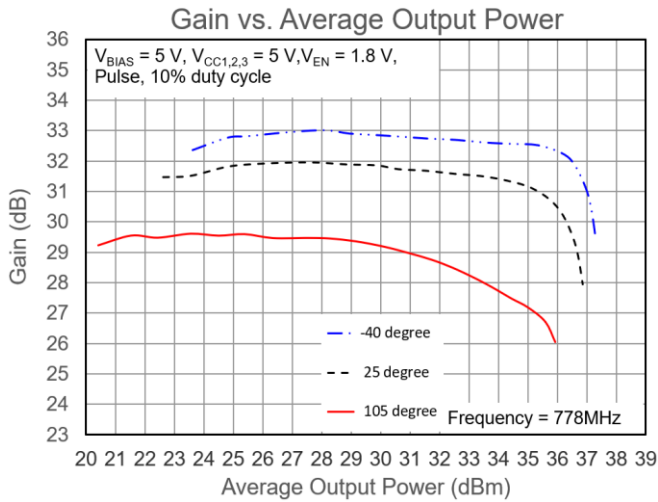

Test conditions unless otherwise noted: $V_{BIAS} = 5V$, $V_{CC1,2,3} = 5V$, $V_{EN} = 1.8V$, tested at 778 MHz using a pulse signal, 10% duty cycle.

Performance Plots – S-parameters

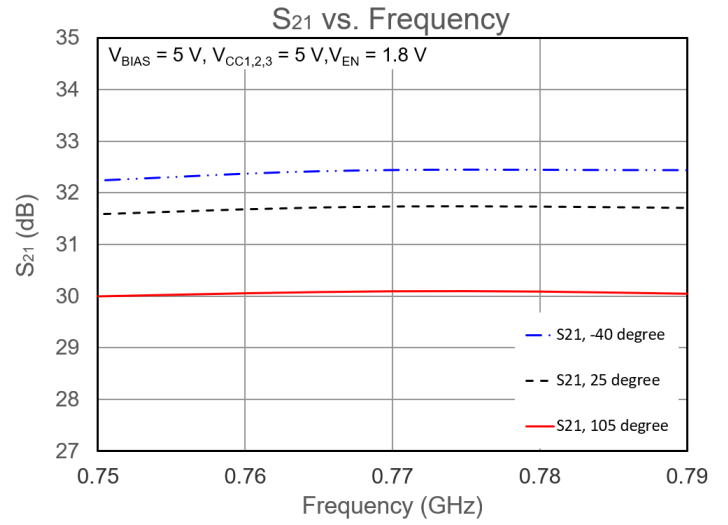
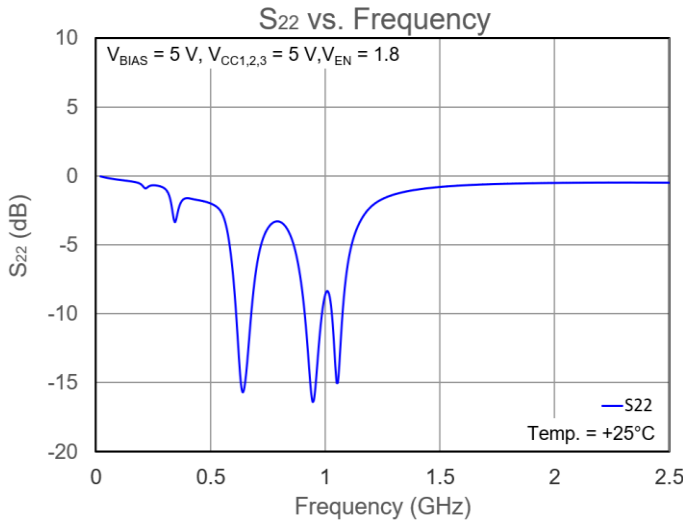
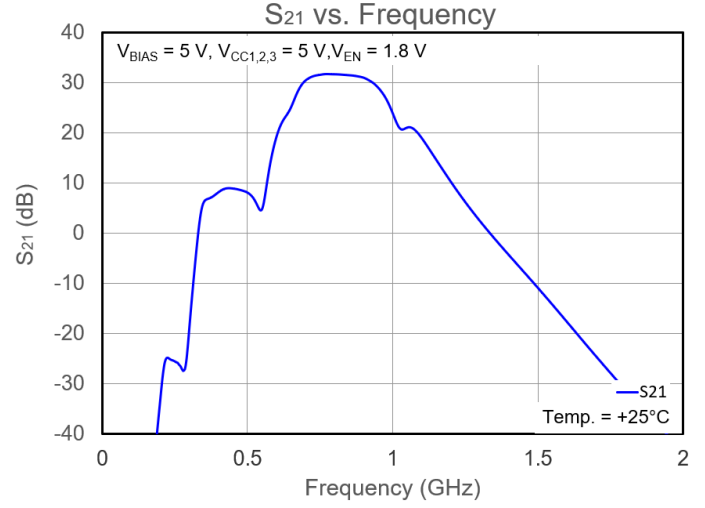
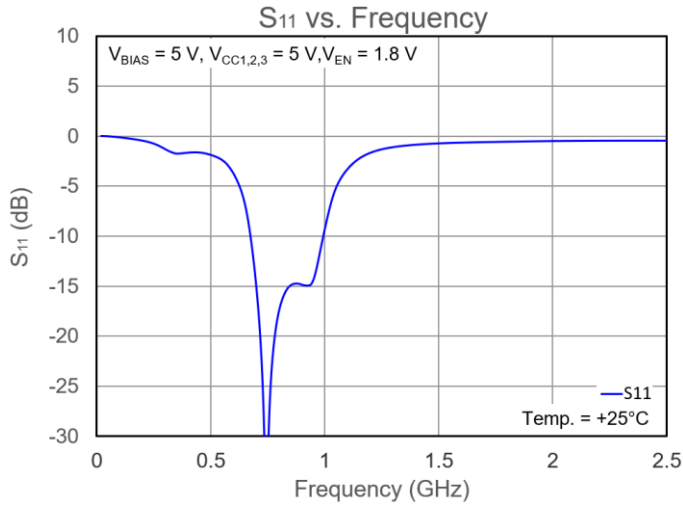

Test conditions unless otherwise noted: $V_{BIAS} = 5\text{ V}, V_{CC1,2,3} = 5\text{ V}, V_{EN} = 1.8\text{ V}$.

Pad Configuration and Description

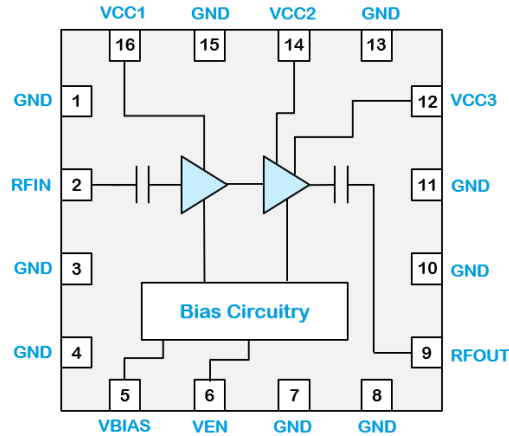

Top View

| Pad No. | Label | Description |
|------------------------------|-------------------|---|
| 1, 3, 4, 7, 8,10, 11, 13, 15 | GND | Ground connection. |
| 2 | RF _{IN} | RF input, internally matched to 50Ω. DC blocked. |
| 5 | V _{BIAS} | Bias circuit supply voltage |
| 6 | V _{EN} | Amplifier enable voltage (regulated internally) |
| 9 | RF _{OUT} | RF output internally matched to 50Ω. It has low impedance at DC. An external series capacitor is required if high impedance is needed at DC. |
| 12 | V _{CC3} | Supply voltage for the various amplifier stages |
| 14 | V _{CC2} | Supply voltage for the various amplifier stages |
| 16 | V _{CC1} | Driver stage supply voltage |
| Backside Paddle | GND | Ground connection. The back side of the package should be connected to the ground plan though as short of a connection as possible. PCB via holes under the device are recommended. |

Package Marking and Dimensions

Marking: Pin 1 Indicator and Qorvo Logo
 Part Number – QPA9909
 Trace Code – XXXXXX Up to 8 Characters to be Assigned by sub-Contractor

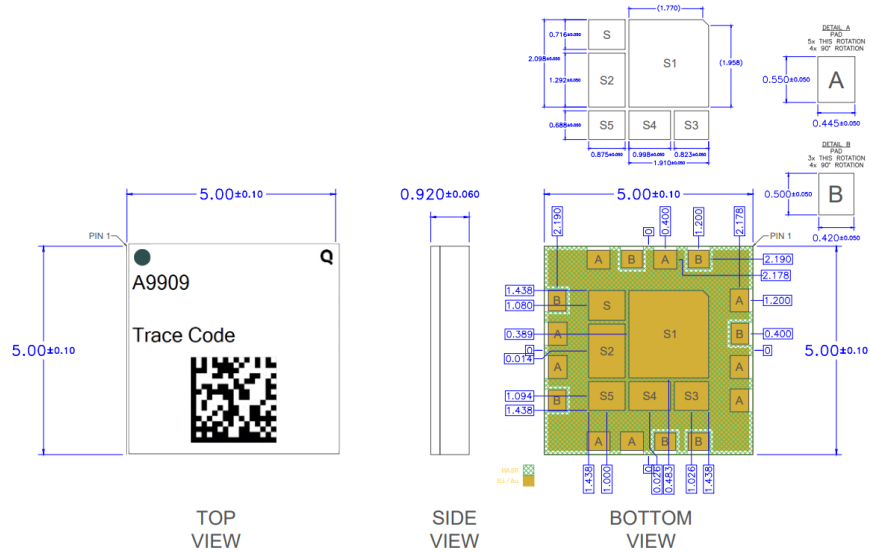

- Notes:
1. All dimensions are in millimeters. Angles are in degrees.
 2. The terminal #1 identifier and terminal numbering conform to JESD 95-1 SPP-012.
 3. Contact plating: ENEPIG (Electroless Nickel Electroless Palladium Immersion Gold)

PCB Mounting Pattern

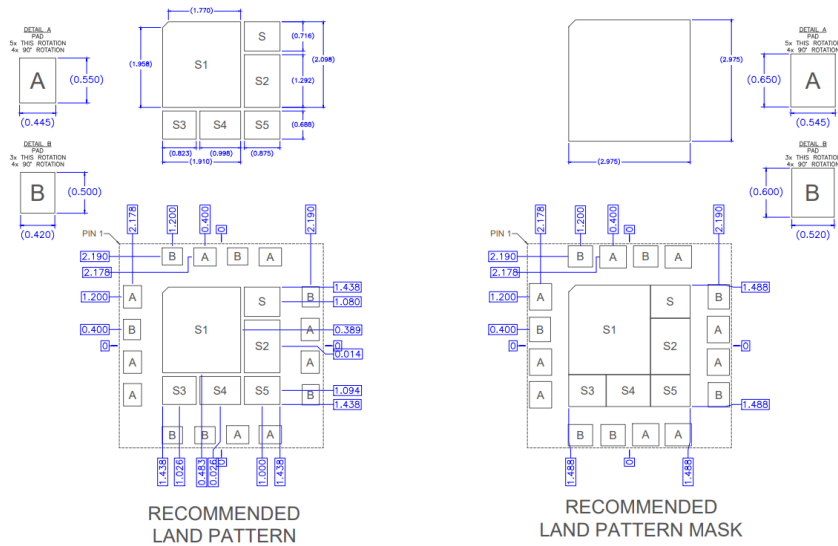

Evaluation Board PCB Information

PC Board Layout

PCB Material (stackup)

| Layer | Name | Material | Thickness | Constant |
|-------|--------------|---------------|-----------|----------|
| 1 | Top Overlay | | | |
| 2 | Top Solder | Solder Resist | 0.40 mil | 3.5 |
| 3 | Top Layer | Copper | 1.40 mil | |
| 4 | Dielectric1 | RO4350 | 20.00 mil | 3.48 |
| 5 | Bottom Layer | Copper | 1.40 mil | |

Total thickness: 23.2mil

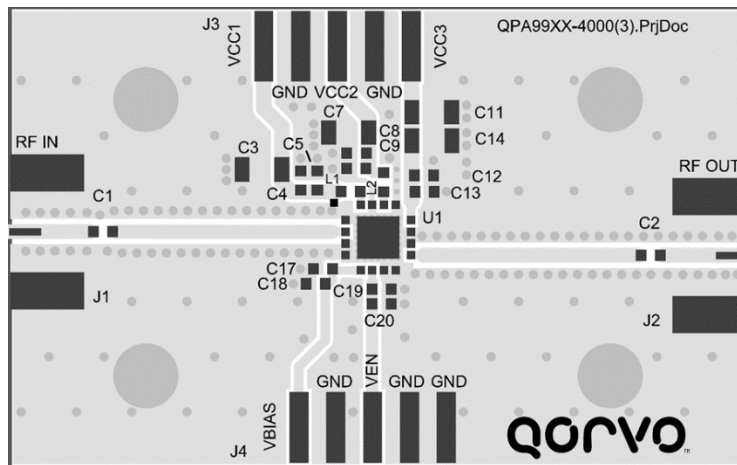

Notes:

1. All dimensions are in millimeters. Angles are in degrees.
2. Use 1 oz. copper minimum for top and bottom layer metal.
3. Via holes are required under the backside paddle of this device for proper RF/DC grounding and thermal dissipation. We recommend a 0.35mm (#80/.0135") diameter bit for drilling via holes and a final plated thru diameter of 0.25 mm (0.10").
4. Ensure good package backside paddle solder attach for reliable operation and best electrical performance.

Tape and Reel Information – Carrier and Cover Tape Dimensions

Tape and reel specifications for this part are also available on the Qorvo website.
 Standard T/R size = 2500 pieces on a 13” reel.

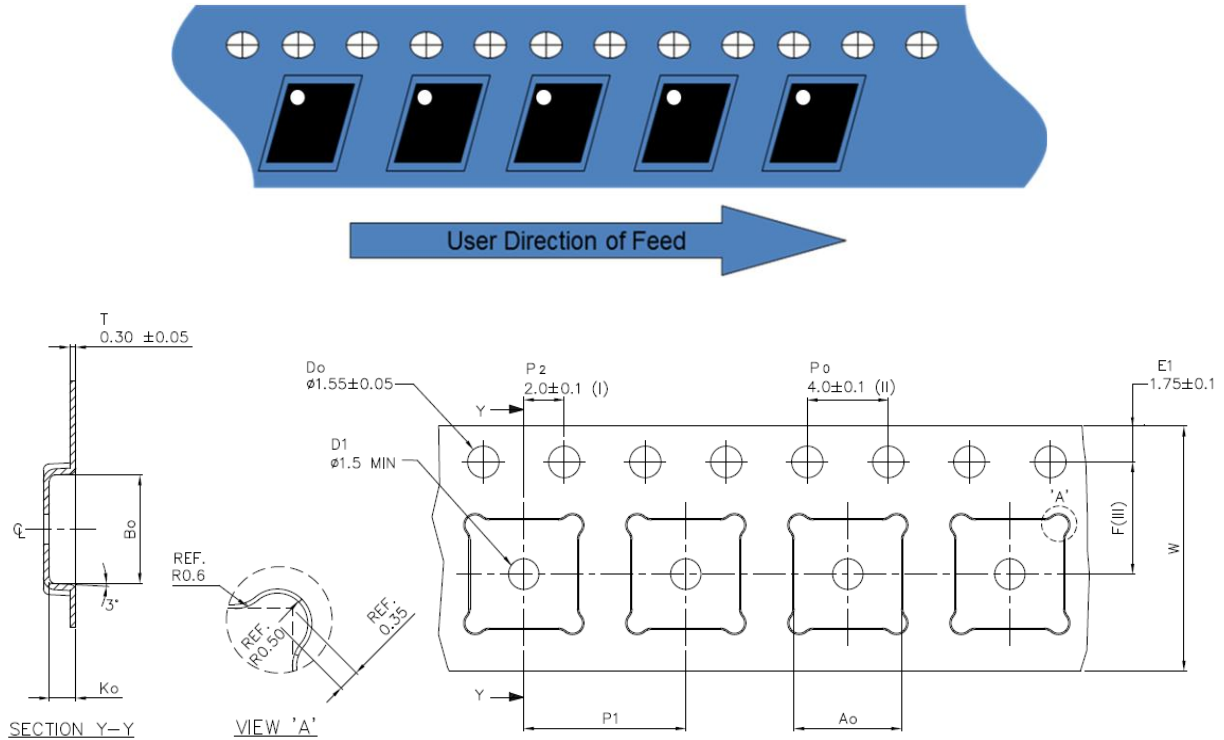

| Feature | Measure | Symbol | Size (in) | Size (mm) |
|---------------------|--|--------|-----------|-----------|
| Cavity | Length | A0 | 0.209 | 5.3 |
| | Width | B0 | 0.209 | 5.3 |
| | Depth | K0 | 0.051 | 1.3 |
| | Pitch | P1 | 0.315 | 8.0 |
| Centerline Distance | Cavity to Perforation - Length Direction | P2 | 0.079 | 2.0 |
| | Cavity to Perforation - Width Direction | F | 0.217 | 5.5 |
| Cover Tape | Width | C | 0.362 | 9.2 |
| Carrier Tape | Width | W | 0.472 | 12 |

Tape and Reel Information – Reel Dimensions

Packaging reels are used to prevent damage to devices during shipping and storage, loaded carrier tape is typically wound onto a plastic take-up reel. The reel size is 13" diameter. The reels are made from high-impact injection-molded polystyrene (HIPS), which offers mechanical and ESD protection to packaged devices.

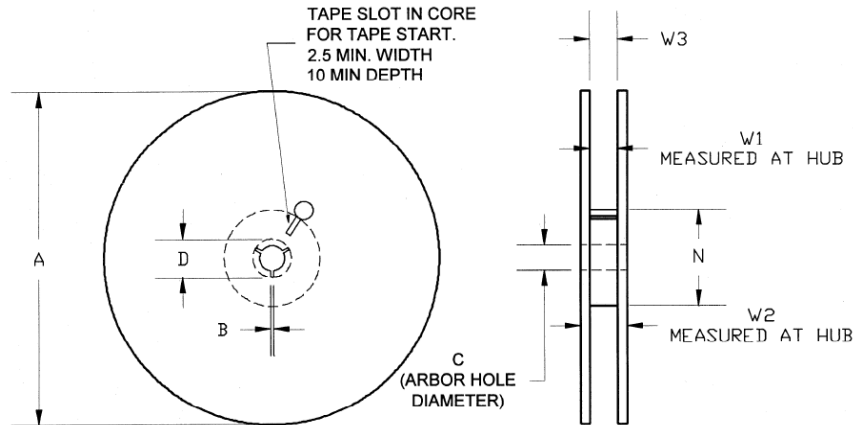

| Feature | Measure | Symbol | Size (in) | Size (mm) |
|---------|----------------------|--------|-----------|-----------|
| Flange | Diameter | A | 12.992 | 330.00 |
| | Thickness | W2 | 0.717 | 18.20 |
| | Space Between Flange | W1 | 0.504 | 12.80 |
| Hub | Outer Diameter | N | 4.016 | 102.00 |
| | Arbor Hole Diameter | C | 0.512 | 13.00 |
| | Key Slit Width | B | 0.079 | 2.00 |
| | Key Slit Diameter | D | 0.795 | 20.2 |

Tape and Reel Information – Tape Length and Label Placement

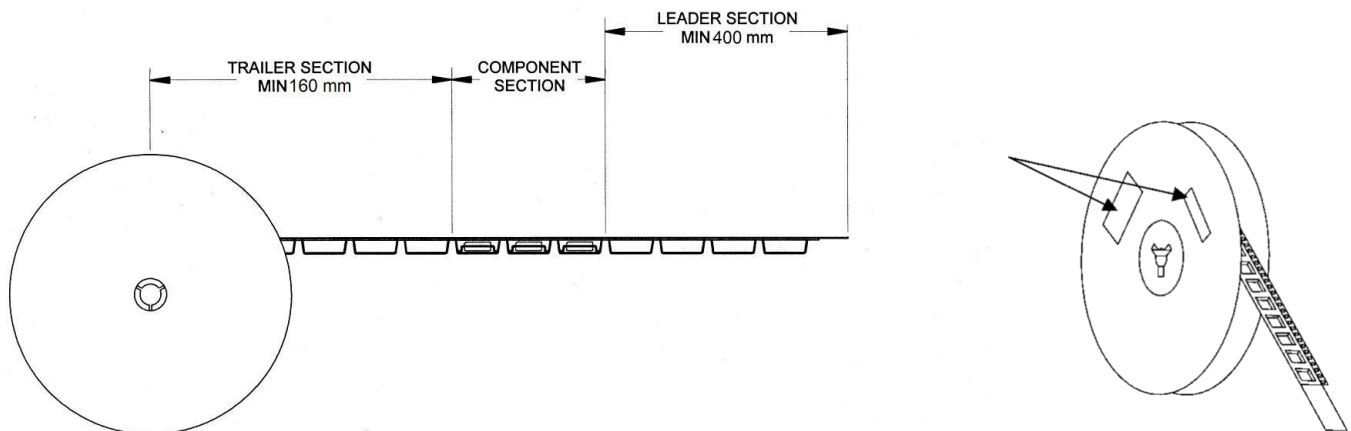

Notes:

1. Empty part cavities at the trailing and leading ends are sealed with cover tape. See EIA 481.
2. Labels are placed on the flange opposite the sprockets in the carrier tape.

Recommended Solder Temperature Profile

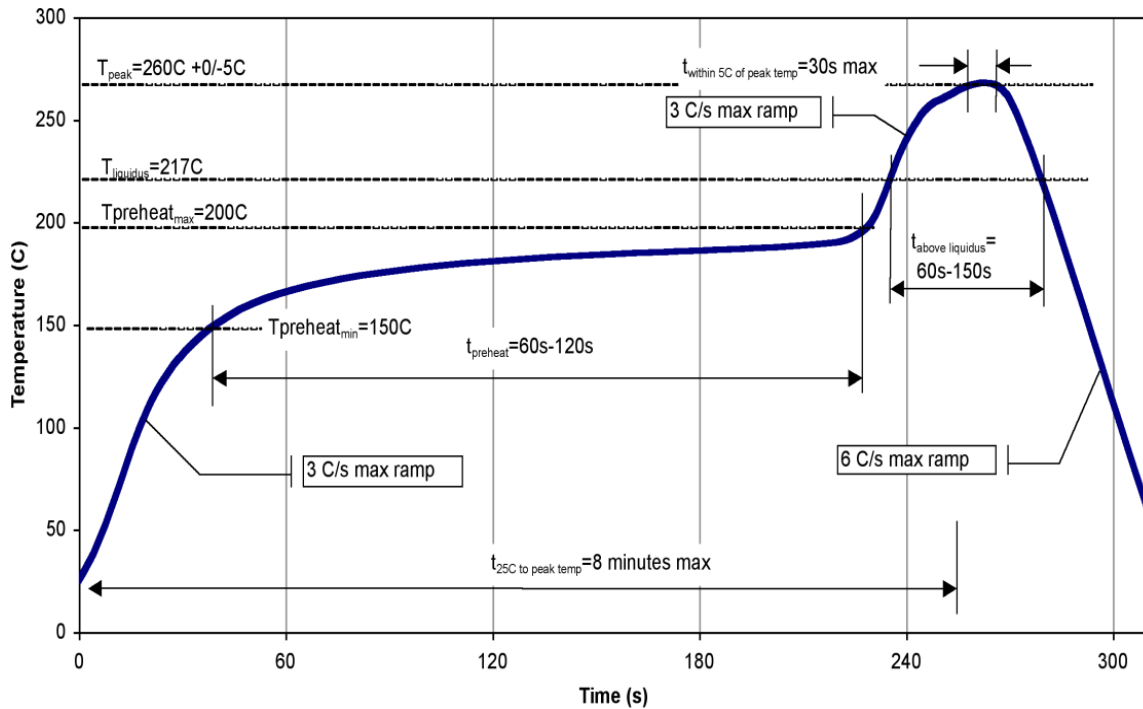

Handling Precautions

| Parameter | Rating | Standard |
|----------------------------------|--------|--------------------------|
| ESD – Human Body Model (HBM) | 1C | ESDA / JEDEC JS-001-2012 |
| ESD – Charged Device Model (CDM) | C3 | JEDEC JESD22-C101F |
| MSL – Moisture Sensitivity Level | 3 | IPC/JEDEC J-STD-020 |



Caution!
ESD-Sensitive Device

Solderability

Compatible with both lead-free (260°C max. reflow temp.) and tin/lead (245°C max. reflow temp.) soldering processes. Solder profiles available upon request.

Contact plating: ENEPIG (Electroless Nickel Electroless Palladium Immersion Gold)

RoHS Compliance

This part is compliant with 2011/65/EU RoHS directive (Restrictions on the Use of Certain Hazardous Substances in Electrical and Electronic Equipment) as amended by Directive 2015/863/EU.

This product also has the following attributes:

- Product uses RoHS Exemption 7c-I to meet RoHS Compliance requirements.
- Halogen Free (Chlorine, Bromine)
- Antimony Free
- TBBP-A (C15H12Br4O2) Free
- PFOS Free
- SVHC Free

Contact Information

For the latest specifications, additional product information, worldwide sales and distribution locations:

Web: www.qorvo.com

Tel: 1-844-890-8163

Email: customer.support@qorvo.com

For technical questions and application information:

Email: appsupport@qorvo.com

Important Notice

The information contained herein is believed to be reliable; however, Qorvo makes no warranties regarding the information contained herein and assumes no responsibility or liability whatsoever for the use of the information contained herein. All information contained herein is subject to change without notice. Customers should obtain and verify the latest relevant information before placing orders for Qorvo products. The information contained herein or any use of such information does not grant, explicitly or implicitly, to any party any patent rights, licenses, or any other intellectual property rights, whether with regard to such information itself or anything described by such information. **THIS INFORMATION DOES NOT CONSTITUTE A WARRANTY WITH RESPECT TO THE PRODUCTS DESCRIBED HEREIN, AND QORVO HEREBY DISCLAIMS ANY AND ALL WARRANTIES WITH RESPECT TO SUCH PRODUCTS WHETHER EXPRESS OR IMPLIED BY LAW, COURSE OF DEALING, COURSE OF PERFORMANCE, USAGE OF TRADE OR OTHERWISE, INCLUDING THE IMPLIED WARRANTIES OF MERCHANTABILITY AND FITNESS FOR A PARTICULAR PURPOSE.**

Without limiting the generality of the foregoing, Qorvo products are not warranted or authorized for use as critical components in medical, life-saving, or life-sustaining applications, or other applications where a failure would reasonably be expected to cause severe personal injury or death.

Copyright 2022 © Qorvo, Inc. | Qorvo is a registered trademark of Qorvo, Inc.

Looking for pricing, stock, or lifecycle information?

Click below to explore more details on WIN SOURCE:

 [View QPA9909TR13 on WIN SOURCE](#)

 [Qorvo US Inc. Information](#)

Optimize Your Supply Chain with WIN SOURCE Solutions

-  Global Sourcing Solution
-  Obsolete Management
-  Cost Control Management
-  Shortage Management
-  Alternative Solution
-  Excess Inventory Management