



# SKY66394-11: 2000 to 2300 MHz Wide Instantaneous Bandwidth High-efficiency Power Amplifier

### Applications

- FDD and TDD 2G/3G/4G LTE systems
- 3GPP bands 2, 25, 33, 36, and 37 small-cell base stations
- Driver amplifier for micro-base and macro-base stations
- Active antenna array and massive MIMO

### Features

- High efficiency: PAE = 35% @ +28 dBm
- High linearity: +28 dBm with < -50 dBc ACLR with pre-distortion (40 MHz LTE, 8.5 dB PAR signal)
- High gain: 38 dB
- Excellent input and output return loss for 50 Ω systems
- Integrated active bias: performance compensated over temperature
- Integrated enable on/off function: PAEN = 1.7 to 2.5 V
- Single supply voltage: 5.0 V
- Pin-to-pin compatible PA family supporting all 3GPP bands
- Compact (16-pin, 5 x 5 x 1.3 mm) package (MSL3, 260 °C per JEDEC J-STD-020)
- For RoHS and other product compliance information, see the [Skyworks Certificate of Conformance](#).

### Description

The SKY66394-11 is a high efficiency fully input/output matched power amplifier (PA) with high gain and linearity. The compact PA is designed for FDD and TDD 2G/3G/4G LTE small-cell base stations operating from 2000 to 2300 MHz.

The active biasing circuitry is integrated to compensate PA performance over temperature, voltage, and process variation.

The SKY66394-11 is part of high-efficiency, pin-to-pin compatible PA family supporting all 3GPP bands.

Table 1 lists the pin-to-pin compatible parts in the PA family. A block diagram is shown in Figure 1. The device package and pinout are shown in Figure 2. Signal pin assignments and functional pin descriptions are described in Table 2.

**Table 1. Pin-to-Pin Compatible PA Family**

Part Number	Frequency (MHz)	3GPP Band
SKY66391-12	1800 to 1900	Bands 3 and 9
SKY66399-11	1900 to 2000	Bands 2, 25, 33, 36, and 37
SKY66394-11	2000 to 2300	Bands 1, 4, 10, and 23
SKY66397-12	2300 to 2700	Bands 7, 38, and 41

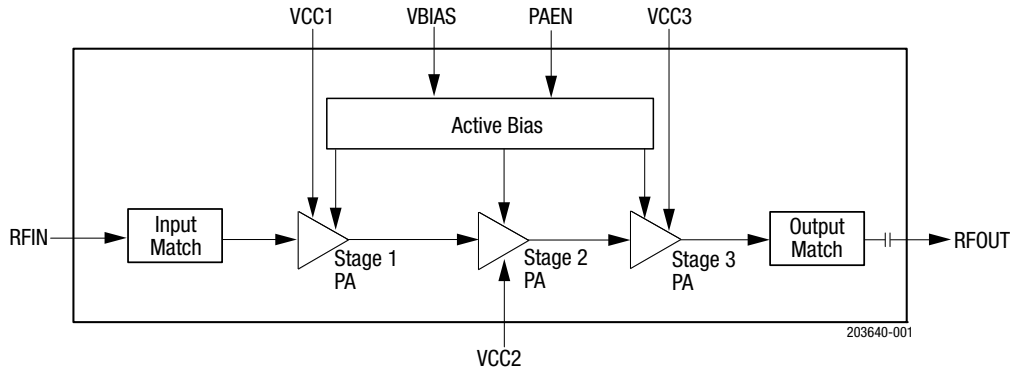

Figure 1. Block Diagram

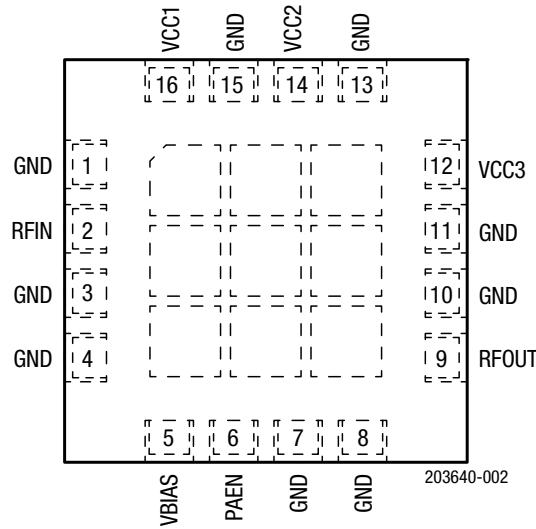

Figure 2. Pinout (Top View)

Table 2. Signal Descriptions<sup>1</sup>

Pin	Name	Description	Pin	Name	Description
1	GND	Ground	9	RFOUT	RF output port
2	RFIN	RF input port <sup>2</sup>	10	GND	Ground
3	GND	Ground	11	GND	Ground
4	GND	Ground	12	VCC3	Stage 3 collector voltage
5	VBIAS	Bias voltage	13	GND	Ground
6	PAEN	PA enable	14	VCC2	Stage 2 collector voltage
7	GND	Ground	15	GND	Ground
8	GND	Ground	16	VCC1	Stage 1 collector voltage

1. The center ground pad must have a low inductance and low thermal resistance connection to the application's printed circuit board ground plane.  
 2. External DC block is required.

## Technical Description

The matching circuits are contained within the device. An on-chip active bias circuit is included within the device for both input and output stages, which provides excellent gain tracking over temperature and voltage variations.

The SKY66399-11 is internally matched for maximum output power and efficiency. The input and output stages are independently supplied using the VCC1, VCC2, and VCC3 supply lines (pins 16, 14, and 12, respectively). The DC control voltage that sets the bias is supplied by the VCBIAS signal (pin 5).

## Electrical and Mechanical Specifications

The absolute maximum ratings of the SKY66394-11 are provided in Table 3. Recommended operating conditions are specified in Table 4, and electrical specifications are provided in Table 5.

Typical performance characteristics are shown in Figures 3 through 14.

**Table 3. Absolute Maximum Ratings<sup>1</sup>**

Parameter	Symbol	Minimum	Maximum	Units
RF input power (CW)	PIN_MAX		+8	dBm
Supply voltage (VCC1, VCC2, VCC3, VBIAS)	Vcc		5.5	V
PA enable	VEN		3	V
Operating temperature	Tc	-40	+100	°C
Storage temperature	TST	-55	+125	°C
Junction temperature	TJ		+150	°C
Power dissipation	Pd		1.9	W
Device thermal resistance	ΘJC		15	°C/W
Electrostatic discharge: Charged Device Model (CDM) Human Body Model (HBM)	ESD		500 1000	V V

1. Exposure to maximum rating conditions for extended periods may reduce device reliability. Exceeding any of the limits listed here may result in permanent damage to the device.

**ESD Handling: Industry-standard ESD handling precautions must be adhered to at all times to avoid damage to this device.**

**Table 4. Recommended Operating Conditions**

Parameter	Symbol	Min	Typ	Max	Units
Supply voltage (VCC1, VCC2, VCC3, VBIAS)	Vcc1, Vcc2, Vcc3, VBIAS	4.75	5	5.25	V
PA enable: ON OFF	PAEN	1.7	2.0 0	2.5 0.5	V V
PA enable current	IENABLE		1	12	μA
Operating frequency	f	2110		2170	MHz
Operating temperature	Tc	-40	+25	+85	°C

**Table 5. Electrical Specifications<sup>1</sup>**

(VCC1 = VCC2 = VCC3 = VBIAS = 5 V, PAEN = 2.0 V, f = 2140 MHz, TC = +25 °C, input/output load = 50 Ω, unless otherwise noted)

Parameter	Symbol	Test Condition	Min	Typ	Max	Units
Small signal gain	S21	P <sub>IN</sub> = -30 dBm	36	38		dB
Gain @ +28 dBm	S21 @ +28 dBm	P <sub>OUT</sub> = +28 dBm	36	38		dB
Input return loss	S11	P <sub>IN</sub> = -20 dBm	12	16		dB
Output return loss	S22	P <sub>IN</sub> = -20 dBm	10	14		dB
Reverse isolation <sup>2</sup>	S12	P <sub>IN</sub> = -30 dBm		50		dB
ACLR @ +28 dBm	ACLR	P <sub>OUT</sub> = +28 dBm (40 MHz LTE, 8.5 dB PAR signal)		-28.5	-27	dBc
Saturated output power	P <sub>SAT</sub>	CW, P <sub>IN</sub> = +5 dBm	+35.5	+36.3		dBm
Output power at 3 dB gain compression <sup>3</sup>	P3dB	CW, reference to gain @ +28 dBm)	+34.5	+35.3		dBm
Second harmonic	2fo	CW, P <sub>OUT</sub> = +28 dBm		-29	-25	dBc
Third harmonic	3fo	CW, P <sub>OUT</sub> = +28 dBm		-63	-55	dBc
Power-added efficiency	PAE	CW, P <sub>OUT</sub> = +28 dBm	32	35		%
Quiescent current	I <sub>CCQ</sub>	No RF signal		105	135	mA

1. Performance is guaranteed only under the conditions listed in this table.
2. Not tested in production. Verified by design.
3. Refer to the performance plot in Figure 7.

### Typical Performance Characteristics

(VCC1 = VCC2 = VCC3 = VBIAS = 5 V, PAEN = 2.0 V, f = 2140 MHz, TC = +25 °C, unless otherwise noted)

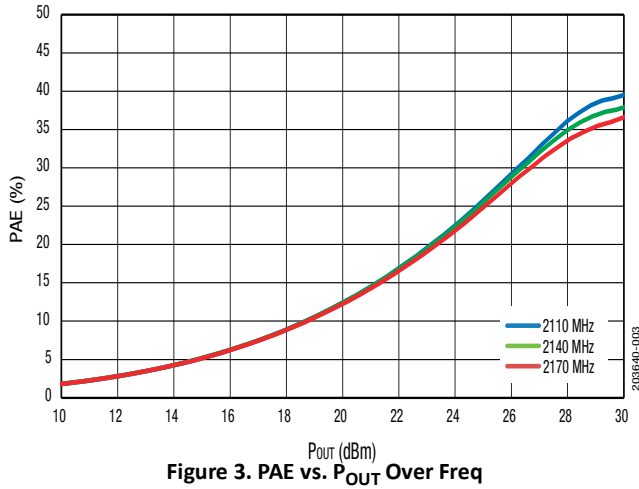

Figure 3. PAE vs. P<sub>OUT</sub> Over Freq

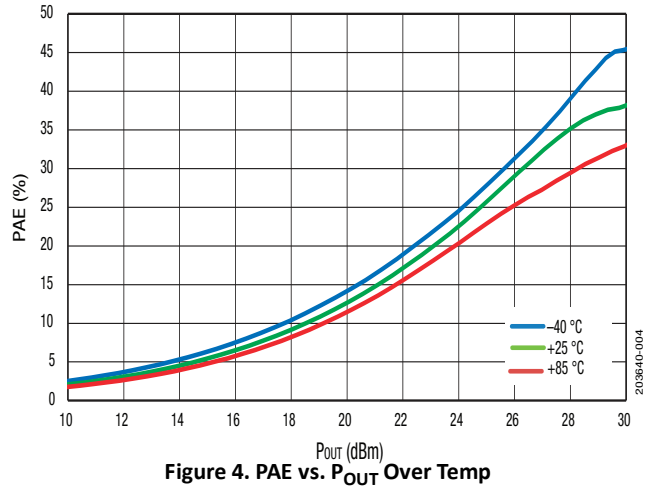

Figure 4. PAE vs. P<sub>OUT</sub> Over Temp

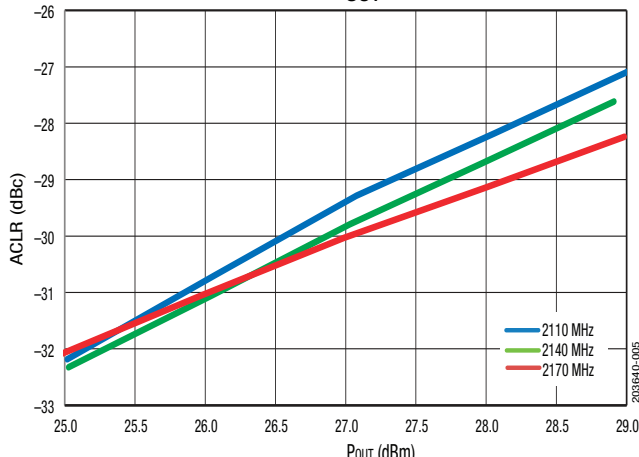

Figure 5. ACLR vs. P<sub>OUT</sub> Over Freq, 40 MHz LTE, PAR = 8.5 dB

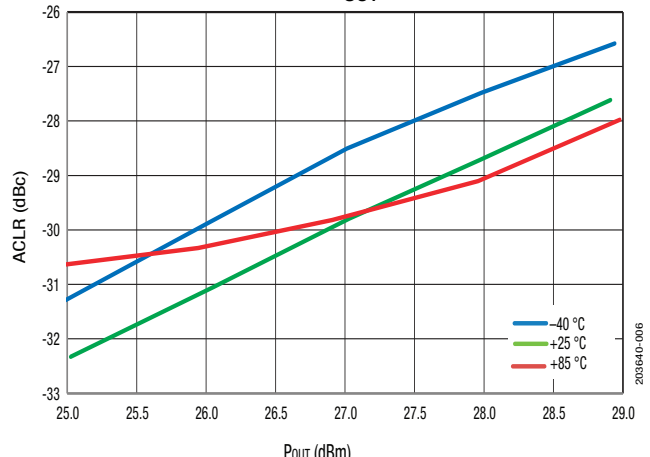

Figure 6. ACLR vs. P<sub>OUT</sub> Over Temp, 40 MHz LTE, PAR = 8.5 dB

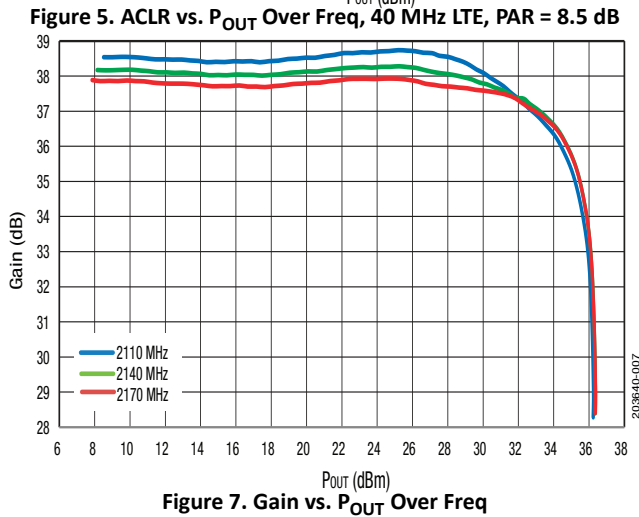

Figure 7. Gain vs. P<sub>OUT</sub> Over Freq

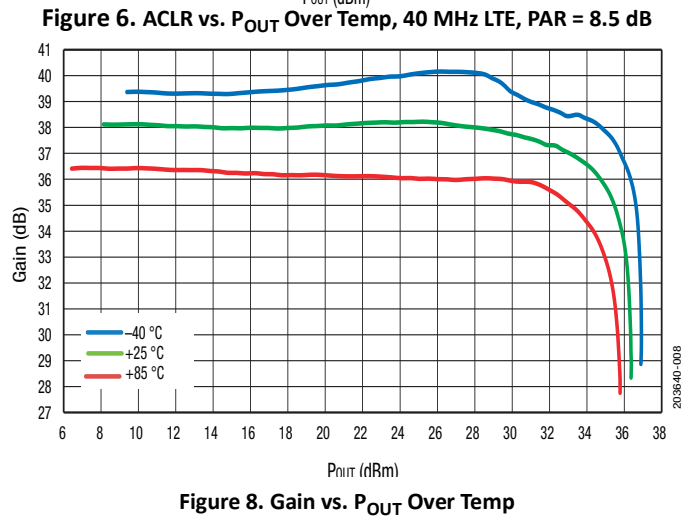

Figure 8. Gain vs. P<sub>OUT</sub> Over Temp

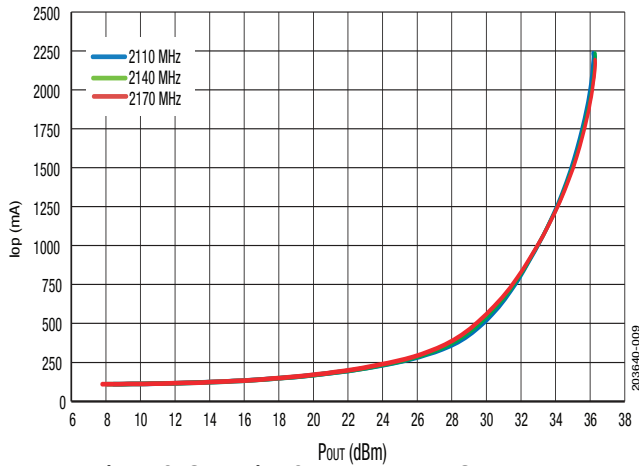

Figure 9. Operating Current vs.  $P_{OUT}$  Over Freq

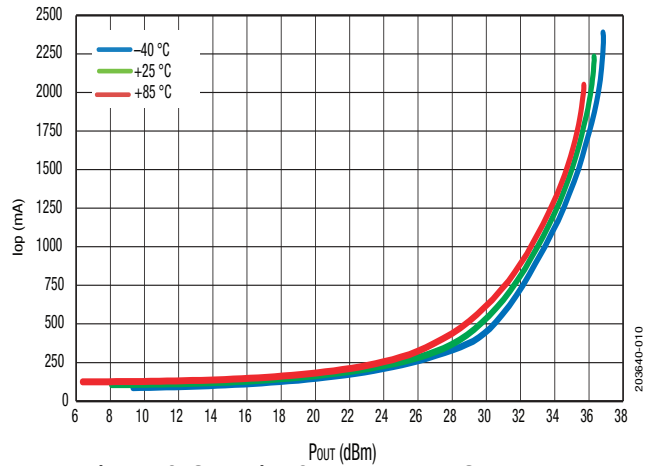

Figure 10. Operating Current vs.  $P_{OUT}$  Over Temp

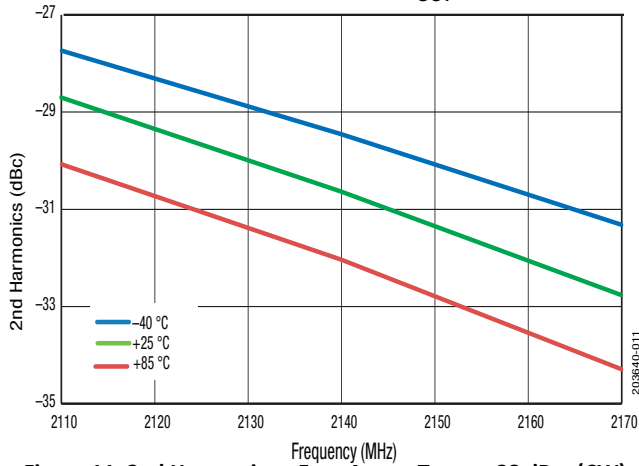

Figure 11. 2nd Harmonic vs Freq Across Temp, +28 dBm (CW)

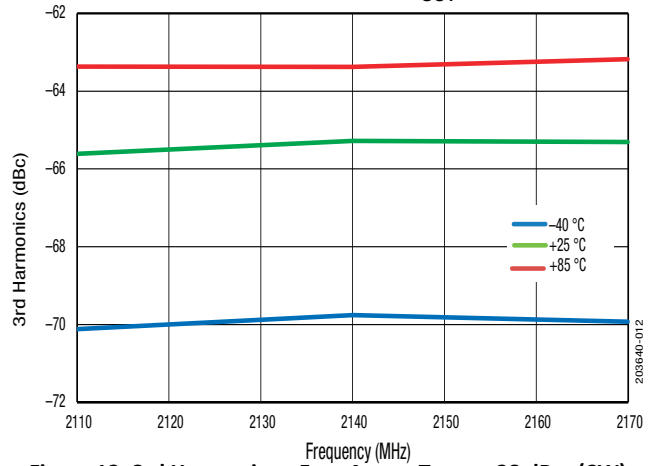

Figure 12. 3rd Harmonic vs Freq Across Temp, +28 dBm (CW)

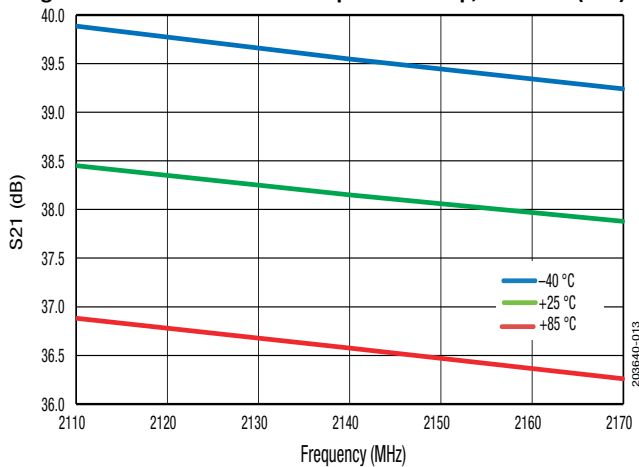

Figure 13. Small Signal Gain vs Freq Over Temp,  $P_{IN} = -30$  dBm

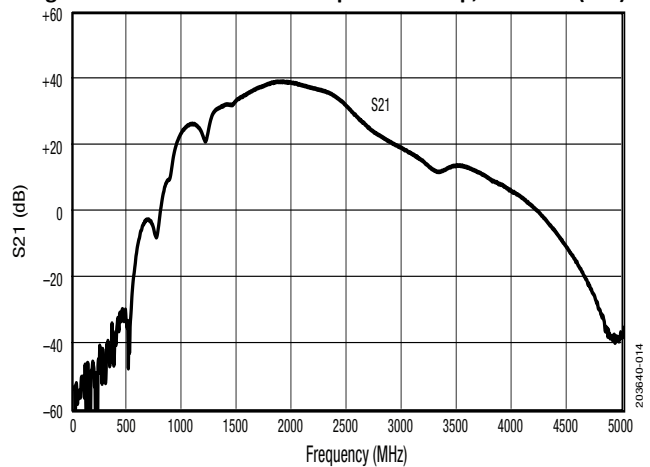

Figure 14. Wide Band Small Signal Gain vs Freq,  $P_{IN} = -30$  dBm

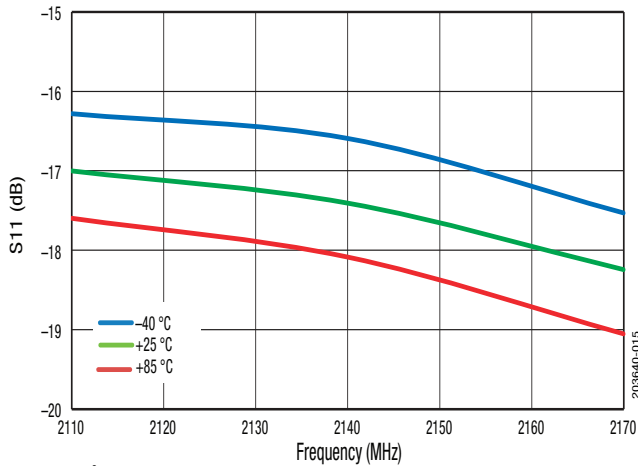

Figure 15. Input Return Loss vs Freq Across Temp, Small Signal, P<sub>IN</sub> = -20 dBm

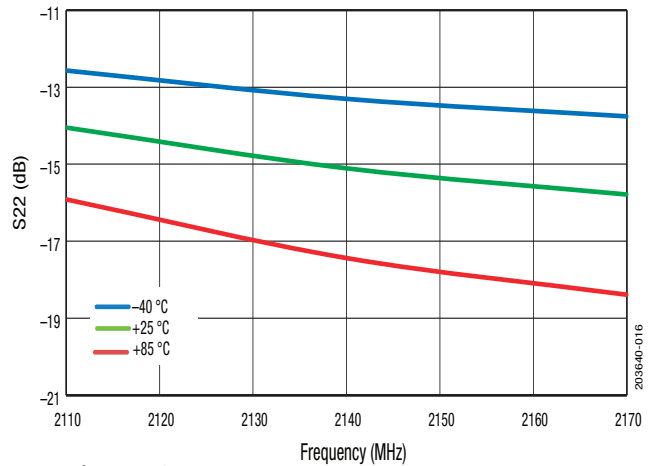

Figure 16. Output Return Loss vs Freq Across Temp, Small Signal, P<sub>IN</sub> = -20 dBm

### Evaluation Board Description

An Evaluation Board is used to test the performance of the SKY66394-11. An application schematic is provided in Figure 17. Table 6 provides the Bill of Materials (BOM) list for Evaluation Board components.

An assembly drawing for the Evaluation Board is shown in Figure 18. Board layer details are shown in Figure 19. Layer detail physical characteristics are noted in Figure 20.

### Circuit Design Considerations

The following design considerations are general in nature and must be followed regardless of final use or configuration:

- Paths to ground should be made as short as possible.
- The ground pad of the SKY66394-11 has special electrical and thermal grounding requirements. This pad is the main thermal conduit for heat dissipation. Because the circuit board acts as the heat sink, it must shunt as much heat as possible from the device.

Therefore, design the connection to the ground pad to dissipate the maximum wattage produced by the circuit board. Multiple vias to the grounding layer are required.

**NOTE:** A poor connection between the ground pad and ground increases junction temperature (T<sub>J</sub>), which reduces the life of the device.

## Evaluation Board Test Procedure

### Turn-on Sequence

1. Connect 50 Ω test equipment or load to the input and output RF ports of the Evaluation Board.
2. Connect the DC ground.
3. Connect all VCCs and VBIAS lines to a +5 V supply. Connect PAEN to a 2.0 V supply.
4. Without applying RF, turn on the 5 V supply, then turn on the 2 V PAEN.
5. Apply RF signal data at -30 dBm and observe that the gain of the device is approximately 38 dB. Begin measurements.

### Turn-off Sequence

1. Turn off the RF input to the device.
2. Turn off PAEN (set to 0 V).
3. Turn off all VCCs and VBIAS.

**NOTE:** It is important to adjust the VCC voltage sources so that +5 V is measured at the board. High collector currents drop the collector voltage significantly if long leads are used. Adjust the bias voltage to compensate.

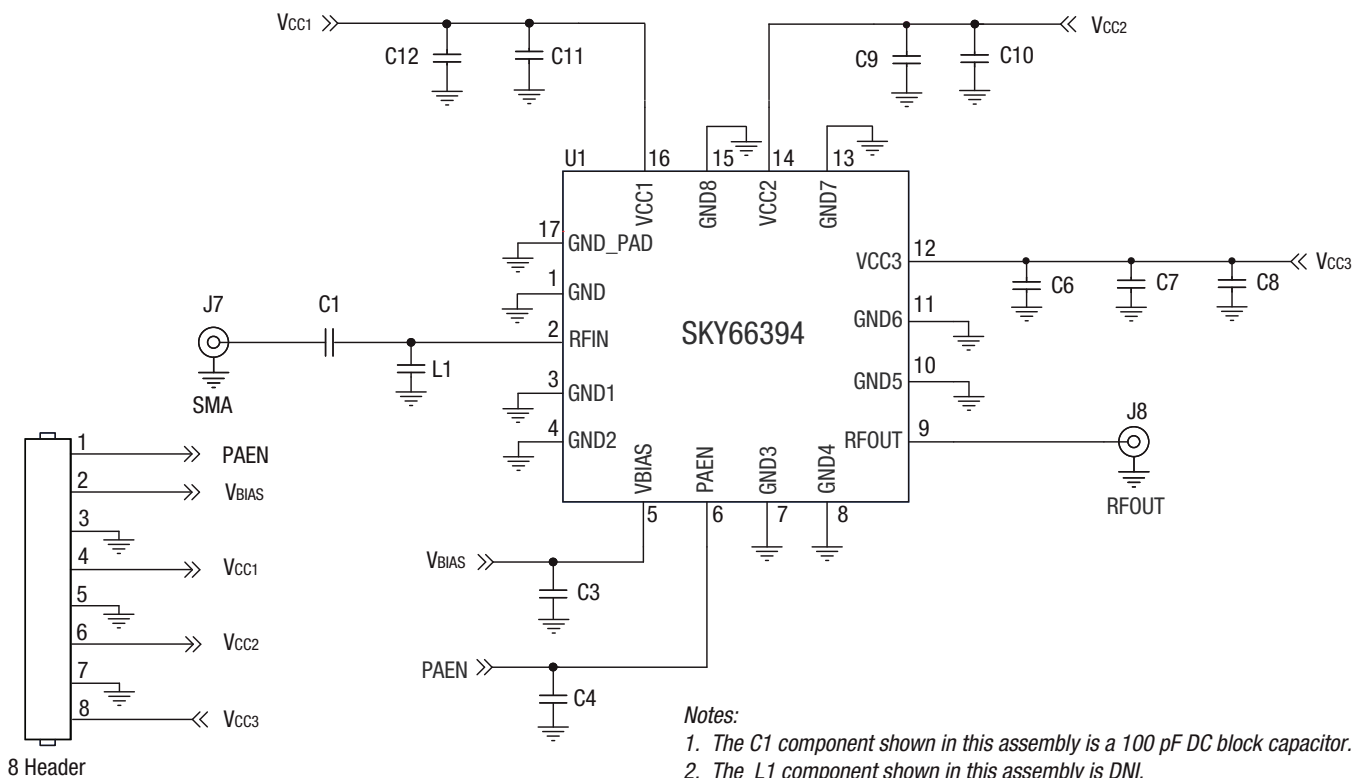
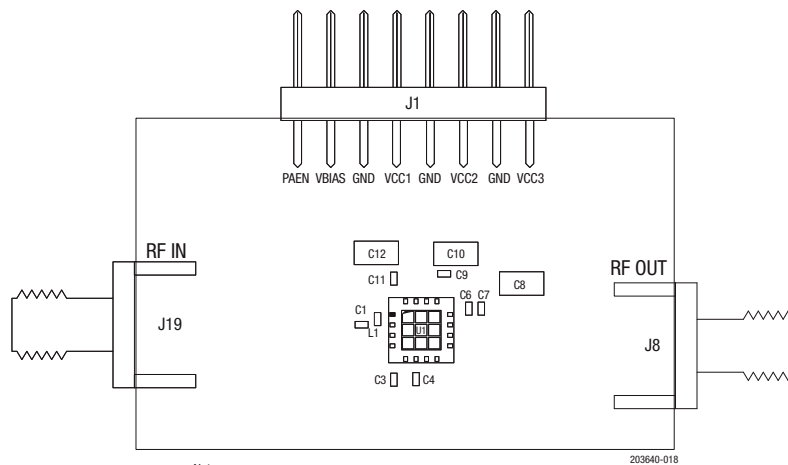

Figure 17. Application Schematic

203640-017

**Table 6. Evaluation Board Bill of Materials (BOM)**

Component	Description	Size
C1	Ceramic capacitor, 100 pF	0402
C3	Ceramic capacitor, 1 $\mu$ F, $\pm$ 10%, 16 V	0402
C4, C7	Ceramic capacitor, 3300 pF, X7R, $\pm$ 10%, 50 V	0402
C6, C9, C11	Ceramic capacitor, 0.22 $\mu$ F	0402
C8, C10, C12	Ceramic capacitor, 10 $\mu$ F, X7R, $\pm$ 10%, 16 V	1206
L1	DNI	
TW21-D690-xxxx	Evaluation board	



Notes:  
 1. Evaluation Board Gerber files are available on request.  
 2. The L1 component shown in this assembly is DNI.

**Figure 18. Evaluation Board Assembly Drawing**

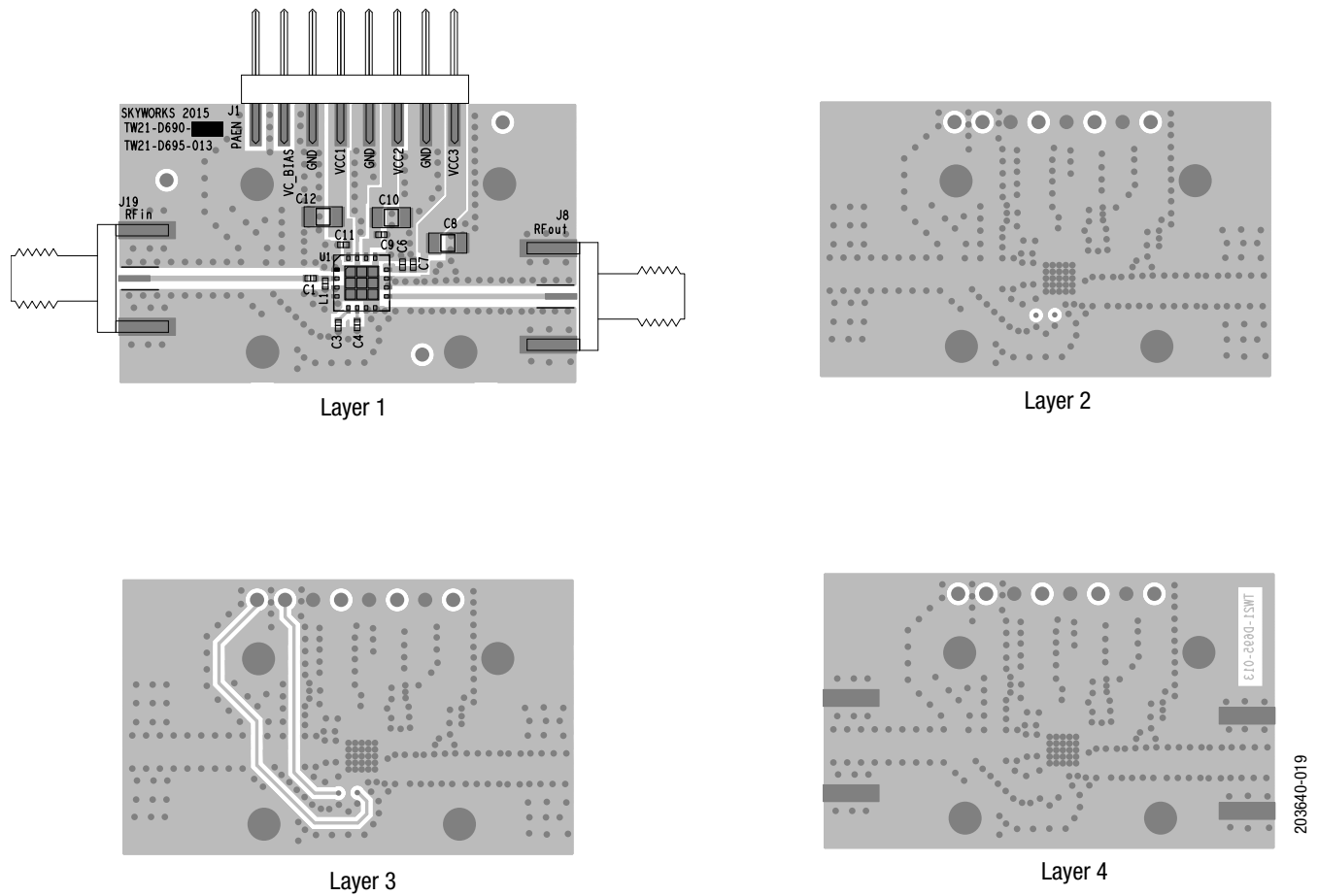

Figure 19. Board Layer Detail

50 Ohm	Cross Section	Name	Thickness (mm)	Materials
W = 0.500 mm 		TMask	0.010	Solder Resist
		L1	0.035	Cu, 1 oz.
		Dielectric	0.250	R04350
		L2	0.035	Cu, 1 oz.
		Dielectric	0.350	FR4
		L3	0.035	Cu, 1 oz.
		Dielectric	0.250	FR4
		L4	0.035	Cu, 1 oz.
		BMask	0.010	Solder Resist

203640-020

Figure 20. Layer Detail Physical Characteristics

### Application Circuit Notes

**Center Ground.** It is extremely important to sufficiently ground the bottom ground pad of the device for both thermal and stability reasons. Multiple small vias are acceptable and work well under the device if solder migration is an issue.

**GND (pins 1, 3, 4, 7, 8, 10, 11, 13, and 15).** Attach all ground pins to the RF ground plane with the largest diameter and lowest inductance via that the layout allows. Multiple small vias are acceptable and will work well under the device if solder migration is an issue.

**VCBIAS (pin 5).** The bias supply voltage for each stage, nominally set to +5 V.

**RFOUT (pin 9).** Amplifier RF output pin ( $Z_0 = 50 \Omega$ ). The module includes an internal DC blocking capacitor. All impedance matching is provided internal to the module.

**VCC1, VCC2, and VCC3 (pin 16, 15, and 12, respectively).** Supply voltage for each stage collector bias is nominally set to 5 V. Bypass and decoupling capacitors C6 through C12 should be placed in the approximate location shown on the evaluation board assembly drawing, although exact placement is not critical.

**RFIN (pin 2).** Amplifier RF input pin ( $Z_0 = 50 \Omega$ ). All impedance matching is provided internal to the module. DC block C1 should be placed in the approximate location shown on the Evaluation Board assembly drawing.

### Package and Handling Information

Since the device package is sensitive to moisture absorption, it is baked and vacuum packed before shipping. Instructions on the shipping container label regarding exposure to moisture after the container seal is broken must be followed. Otherwise, problems related to moisture absorption may occur when the part is subjected to high temperature during solder assembly.

The SKY66394-11 is rated to Moisture Sensitivity Level 3 (MSL3) at 260 °C. It can be used for lead or lead-free soldering. For additional information, refer to Skyworks Application Note, PCB Design and SMT Assembly/Rework Guidelines for MCM-L Packages, document number 101752.

Care must be taken when attaching this product, whether it is done manually or in a production solder reflow environment. Production quantities of this product are shipped in a standard tape and reel format.

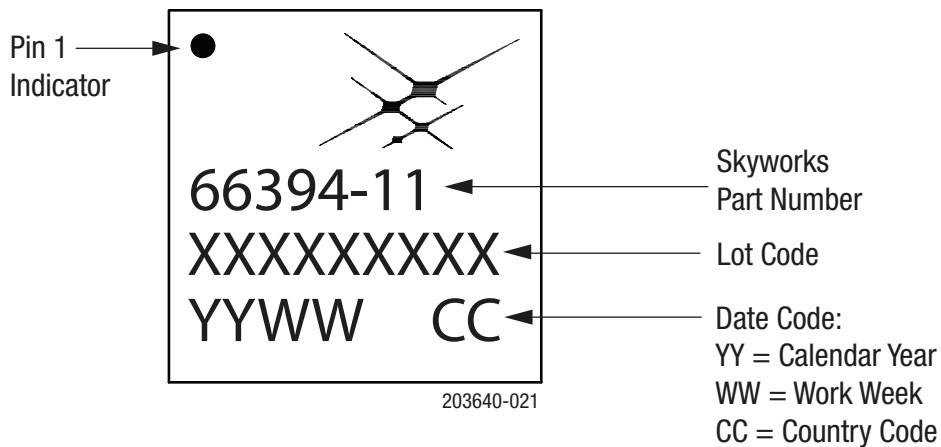
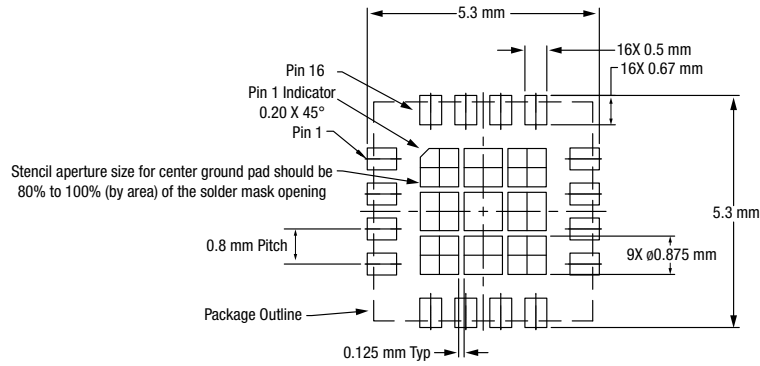
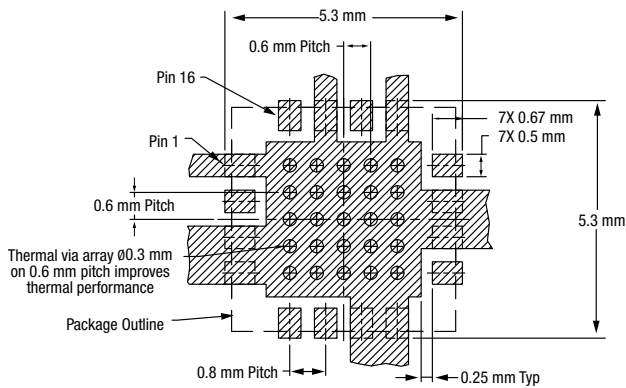

Figure 21. Typical Part Marking



Stencil Aperture  
Top View



Metallization  
Top View

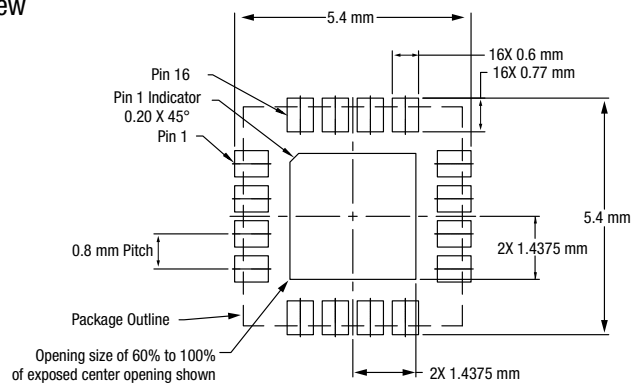

Solder Mask Opening  
Top View

Notes:

1. Thermal vias should be resin filled and capped in accordance with IPC-4761 type VII vias.
2. Recommended Cu thickness is 30 to 35 µm.

203640-022

Figure 22. PCB Layout Footprint

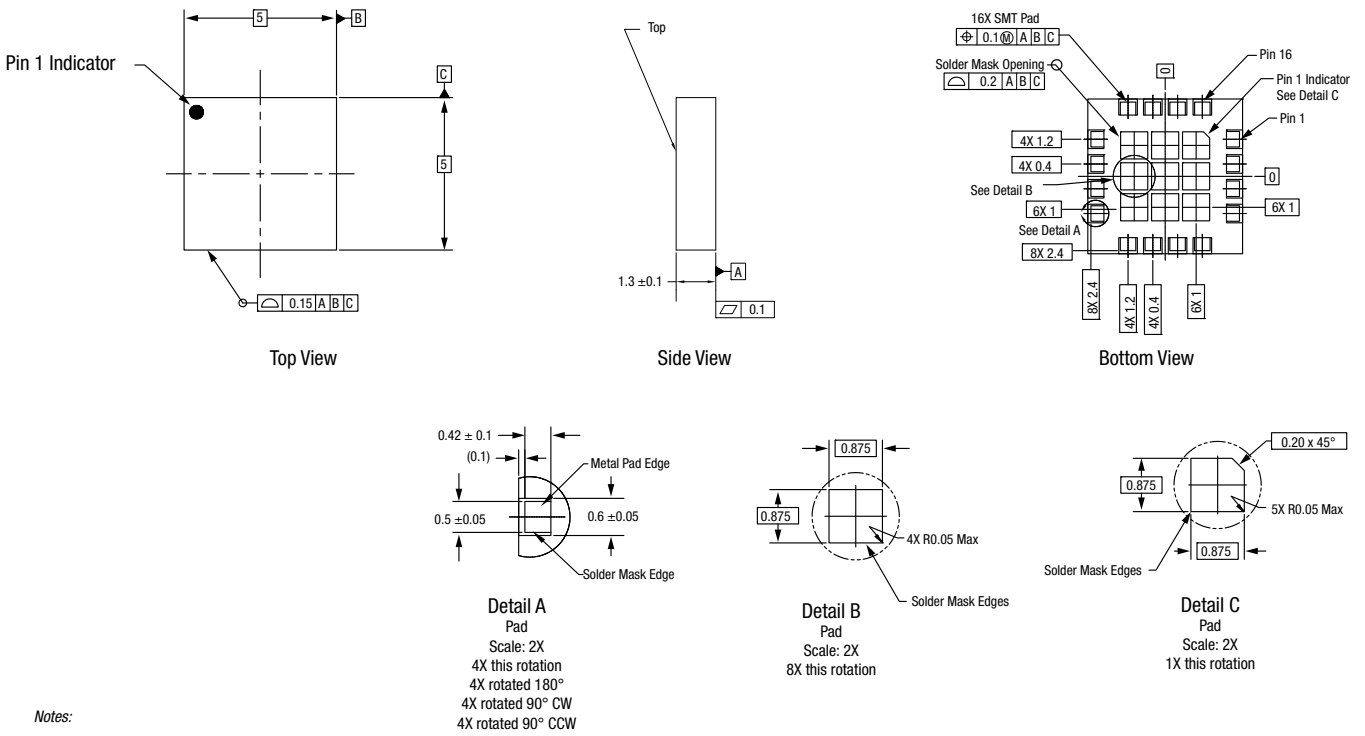

203640-010

Figure 23. Package Dimensions

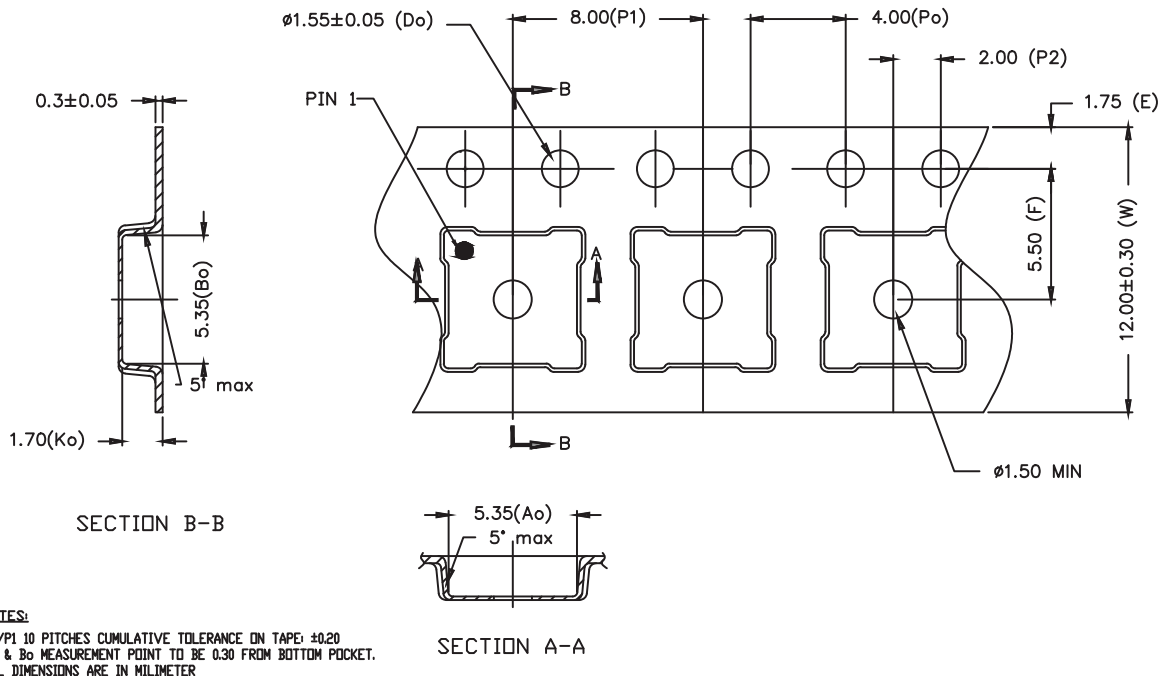

Figure 24. Tape and Reel Dimensions

## Ordering Information

Part Number	Description	Evaluation Board Part Number
SKY66394-11	2000 to 2300 MHz Wide Instantaneous Bandwidth High-efficiency Power Amplifier	SKY66394-11EK1

Copyright © 2015-2016, 2019, 2025, Skyworks Solutions, Inc. All Rights Reserved.

Information in this document is provided in connection with Skyworks Solutions, Inc., and its subsidiaries (“Skyworks”) products or services. These materials, including the information contained herein, are provided by Skyworks as a service to its customers and may be used for informational purposes only by the customer. Skyworks assumes no responsibility for errors or omissions in these materials or the information contained herein. Skyworks may change its documentation, products, services, specifications or product descriptions at any time, without notice. Skyworks makes no commitment to update the materials or information and shall have no responsibility whatsoever for conflicts, incompatibilities, or other difficulties arising from any future changes.

No license, whether express, implied, by estoppel or otherwise, is granted to any intellectual property rights by this document. Skyworks assumes no liability for any materials, products or information provided hereunder, including the sale, distribution, reproduction or use of Skyworks products, information or materials, except as may be provided in Skyworks’ Terms and Conditions of Sale.

THE INFORMATION IN THIS DOCUMENT AND THE MATERIALS AND PRODUCTS DESCRIBED THEREIN ARE PROVIDED “AS IS” WITHOUT WARRANTY OF ANY KIND, WHETHER EXPRESS, IMPLIED, STATUTORY, OR OTHERWISE, INCLUDING FITNESS FOR A PARTICULAR PURPOSE OR USE, MERCHANTABILITY, PERFORMANCE, QUALITY OR NON-INFRINGEMENT OF ANY INTELLECTUAL PROPERTY RIGHT; ALL SUCH WARRANTIES ARE HEREBY EXPRESSLY DISCLAIMED. SKYWORKS DOES NOT WARRANT THE ACCURACY OR COMPLETENESS OF THE INFORMATION, TEXT, GRAPHICS OR OTHER ITEMS CONTAINED WITHIN THESE MATERIALS. SKYWORKS SHALL NOT BE LIABLE FOR ANY DAMAGES, INCLUDING BUT NOT LIMITED TO ANY SPECIAL, INDIRECT, INCIDENTAL, STATUTORY, OR CONSEQUENTIAL DAMAGES, INCLUDING WITHOUT LIMITATION, LOST REVENUES OR LOST PROFITS THAT MAY RESULT FROM THE USE OF THE MATERIALS OR INFORMATION, WHETHER OR NOT THE RECIPIENT OF MATERIALS HAS BEEN ADVISED OF THE POSSIBILITY OF SUCH DAMAGE.



Skyworks products are not designed, intended, authorized, or warranted for use or inclusion in life support or life endangering applications, devices, or systems where failure or inaccuracy might cause death or personal injury. Skyworks customers agree not to use or sell the Skyworks products for such applications, and further agree to, without limitation, fully defend, indemnify, and hold harmless Skyworks and its agents from and against any and all actions, suits, proceedings, costs, expenses, damages, and liabilities including attorneys’ fees arising out of or in connection with such improper use or sale.

Skyworks assumes no liability for applications assistance, customer product design, or damage to any equipment resulting from the use of Skyworks products outside of Skyworks’ published specifications or parameters. Customers are solely responsible for their products and applications using the Skyworks products.

“Skyworks” and the Skyworks Starburst logo are registered trademarks of Skyworks Solutions, Inc., in the United States and other countries. Third-party brands and names are for identification purposes only and are the property of their respective owners. Additional information, including relevant terms and conditions, posted at [www.skyworksinc.com](http://www.skyworksinc.com), are incorporated by reference.

## Looking for pricing, stock, or lifecycle information?

Click below to explore more details on WIN SOURCE:

-  [View SKY66394-11 on WIN SOURCE](#)
-  [Skyworks Solutions Inc. Information](#)

## Optimize Your Supply Chain with WIN SOURCE Solutions

-  Global Sourcing Solution
-  Obsolete Management
-  Cost Control Management
-  Shortage Management
-  Alternative Solution
-  Excess Inventory Management