

Product Overview

The QPL1822 is an ultra-linear, GaAs pHEMT, differential RF amplifier. The device features a cascode design which provides 15dB of gain along with very low distortion from 5MHz to 1.8GHz. This ultra-linear IC is designed to support Broadband CATV DOCSIS 4.0 applications, such as Nodes, Amplifiers, and Remote PHY Devices, as well as Fiber to The Home (FTTH), Home Gateways, and Cable Modems. The device is powered by a single supply that can operate from 5V to 8V and current can be set from 260mA to 350mA. At 5V and 260mA, the QPL1822 provides an output of 63dBmV TCP with a CCN of 58dB. When driven with 8V and 350mA, the output is 67dBmV TCP with a CCN of 56dB. The QPL1822 is packaged in a 12-pin 5x5 mm² Laminate Module

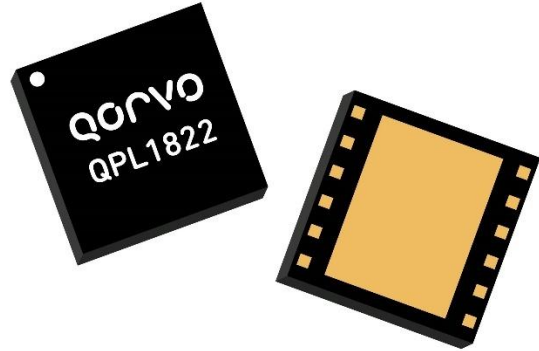

5 x 5 12-pin Laminate MCM Package

Functional Block Diagram

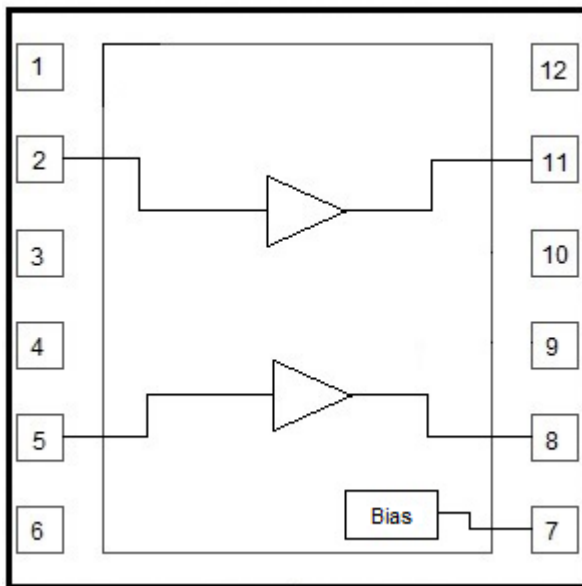

Key Features

- 5 MHz to 1800 MHz Operation
- 5V & 8V Operation
- Gain: 15dB Typical
- TCP: 63dBmV @ 5V
- TCP: 67dBmV @ 8V
- Noise Figure: 2.2/3.6dB @ 50/1800MHz
- Adjustable Bias Using External Resistors
- RoHS Compliant

Applications

- DOCSIS 4.0 Amplifiers
- DOCSIS 4.0 Optical Nodes
- DOCSIS 4.0 Remote PHY Devices
- FTTH GPON and GEPON
- DOCSIS 4.0 Cable Modem and Home Gateways

Ordering Information

Part Number	Description	Part Number	Description
QPL1822EVB-01	5V Downstream Evaluation Board	QPL1822SB	Sample bag with 5 pieces
QPL1822EVB-02	5V Upstream Evaluation Board	QPL1822SR	7" Reel with 100 pieces
QPL1822EVB-03	8V Downstream Evaluation Board	QPL1822TR13	13" Reel with 2500 pieces
QPL1822EVB-04	8V Upstream Evaluation Board		

Table of Contents

Absolute Maximum Ratings	3
Electrical Specifications_(Downstream)	3
Evaluation Board Schematic 50 MHz – 1800 MHz (Downstream).....	4
Evaluation Board Assembly Drawing (Downstream).....	4
Evaluation Board Bill of Materials for Downstream 5V	5
Bill of Materials Changes for Downstream 8V Operation	5
Performance Data, Downstream 5V.....	6-7
Performance Data, Downstream 8V.....	8-9
IADJ Resistor Value, Downstream	10
Electrical Specifications (Upstream).....	11
Evaluation Board Schematic 5 MHz – 700 MHz (Upstream).....	12
Evaluation Board Assembly Drawing (Upstream)	12
Evaluation Board Bill of Materials for Upstream 5V.....	13
Bill of Materials Changes for Upstream 8V Operation.....	13
Performance Data, Upstream 5V.....	14-16
Performance Data, Upstream 8V.....	17-19
IADJ Resistor Value, Upstream	20
Pin Configuration and Description	21
Package Outline.....	22
Landing Pattern.....	23
Package Marking	24
Tape and Reel	24
Handling Precautions	25
RoHS Compliance	25
Solderability	25
Contact Information.....	25
Important Notice.....	26

Absolute Maximum Ratings

Parameter	Rating
Supply Voltage (V _{DD})	+10 V
Supply Current (I _{DD})	400 mA
Maximum Input Level	+65 dBmV
Operating Temperature Range (Operating Device Heat Slug Temperature)	-40 to +100 °C
Storage Temperature Range	-65 to +150 °C
Maximum Junction Temperature	+150 °C

Exceeding any one or a combination of the Absolute Maximum Rating conditions may cause permanent damage to the device. Extended application of Absolute Maximum Rating conditions to the device may reduce device reliability.

Electrical Specifications (Downstream)

Parameter	Test Condition	Min	Typ	Max	Unit
Supply Voltage (VDD)			5/8		V
Supply Current (IDD)			260/350		mA
Frequency Range		50		1800	MHz
Gain at 50 MHz			15		dB
Gain at 1800 MHz			16		dB
Gain Slope			1		dB
Reverse Isolation			20		dB
Input Return Loss	50 – 1200 MHz		-20		dB
	1200 – 1800 MHz		-20		dB
Output Return Loss	50 – 1200 MHz		-20		dB
	1200 – 1800 MHz		-20		dB
CCN	+63dBmV @ 5V Total Composite Output power		58		dB
	+67dBmV @ 8V Total Composite Output power		56		
	255 to 1791MHz, 280 Ch, SC-QAM, 10dB tilt, 6dB Offset at 1026MHz				
Noise Figure	50MHz		2.2		dB
	1800MHz		3.6		
OIP2L	+12 dBm / tone output, Δf=53MHz, Full Band		83		dBm
OIP2U	+12 dBm / tone output, Δf=53MHz, Full Band		70		dBm
OIP3	+12 dBm / tone output, Δf=6MHz, Full Band		45/48		dBm
OP1dB	50-1800MHz		26/29		dBm
Thermal Resistance	ΘJC (Junction to Device Heat Slug)		12		°C/W

Note: Typical performance at these conditions: Temp = +25 °C, V_{DD} = +5 V, 75 Ω system, Full band unless otherwise noted

Evaluation Board Schematic 50 MHz – 1800 MHz (Downstream)

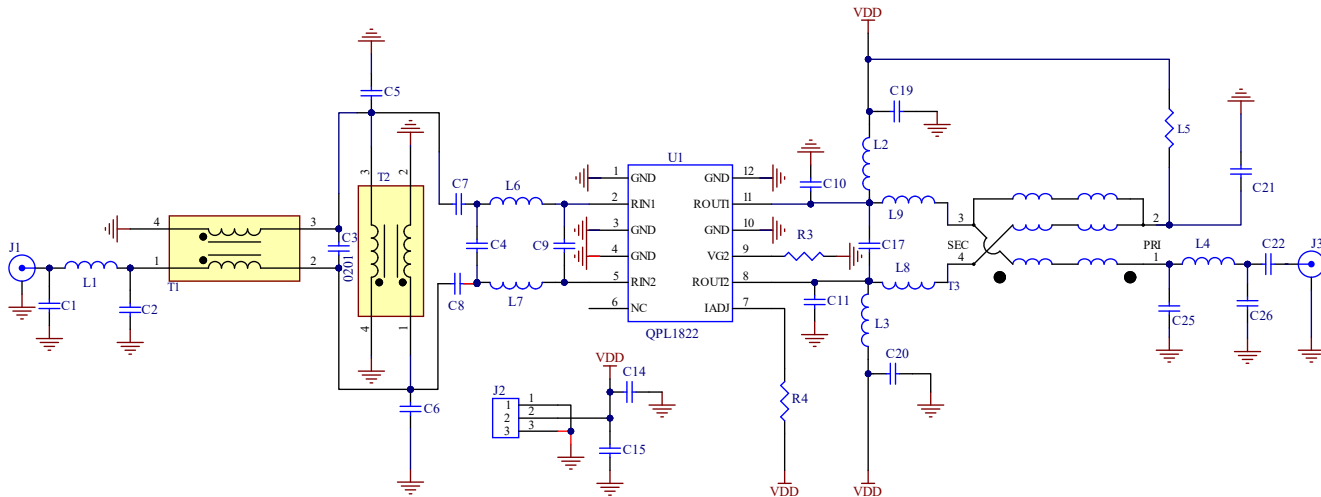

Evaluation Board Assembly Drawing (Downstream)

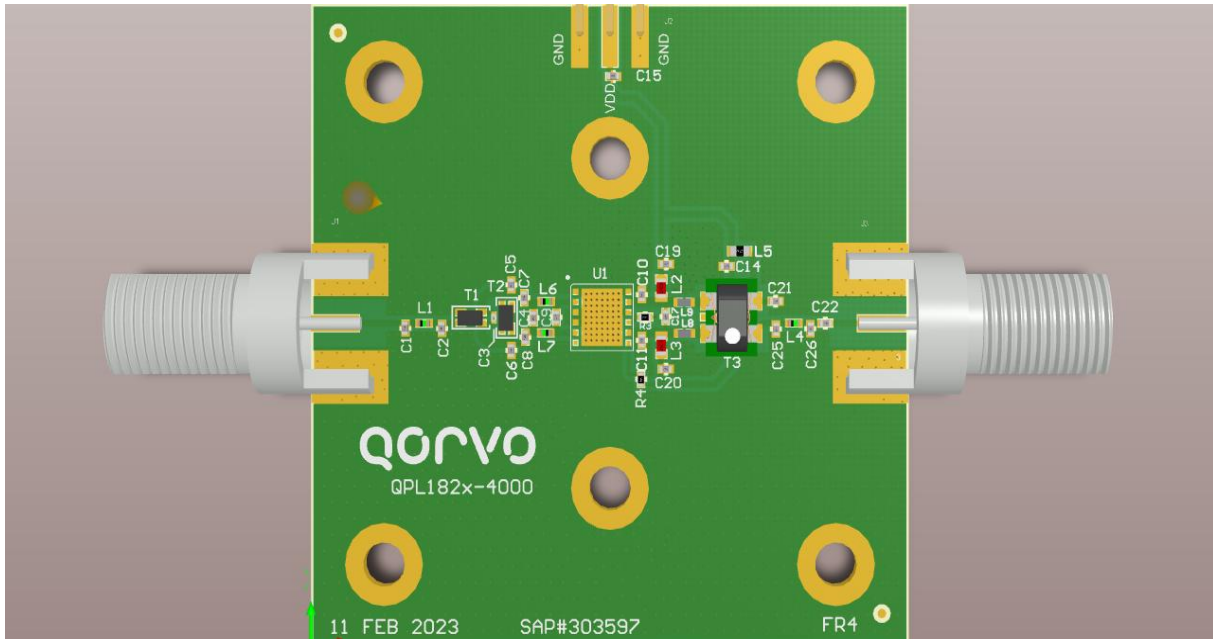

Materials: Isola370HR High-Tg FR4

Layer	Thickness	Primary Stack	Description	Dk / Df
Layer - 1	0.0010 0.0020		Taiyo 4000-HFX DI 1/2oz Mix (Std Plt)	3.50 / 0.0190
Layer - 2	0.0578 0.0020		370H 1/2oz Mix (Std Plt)	4.34 / 0.0180



Evaluation Board Bill of Materials for Downstream 5V

Ref Des	Description	Mfg Name	Mfg Part #
PCB	PCB, QPL182X-4000	Qorvo	QPL1823-4000(A)
U1	1.8GHZ 5V, 15dB Gain	Qorvo	QPL1822
C3	CAP, 0.2pF, +/-0.1pF, 25V, 0201	MURATA	GJM0335C1ER20BB01D
C4	CAP, 0.7pF, +/-0.1pF, 50V, HI-Q, 0402	MURATA	GJM1555C1HR70BB01D
C7, C8	CAP, 1000pF, 5%, 50V, C0G, 0402	MURATA	GRM1555C1H102JA01D
C2, C17	CAP, 0.2pF, +/-0.1pF, 50V, 0402	MURATA	GJM1555C1HR20BB01D
C14, C19, C20, C21	CAP, 0.01uF, 10%, 50V, X7R, 0402	MURATA	GCM155R71H103KA55D
C22	CAP, 470pF, 5%, 50V, C0G, 0402	MURATA	GRM1555C1H471JA01D
C15	CAP, 0.1uF, 10%, 25V, X7R, 0402	MURATA	GRM155R71E104KE14D
L8, L9	RES, 0 OHM, 5%, 1/10W, 0402	Kamaya, Inc	RMC1/16SJPTH
R3	RES, 3.6K, 5%, 1/16W, 0402	Kamaya, Inc	RMC1/16S-362JTH
R4	Res, 1.3K /1%/0402/TK100, 0402	Kamaya, Inc	RMC1/16SK1301FTH
L4	IND, 1.2nH, +/-0.3nH, M/L, 0402	MURATA	LQG15HN1N2S02D
L6, L7	IND, 2.2nH, +/-0.3nH, M/L, 0402	MURATA	LQG15HN2N2S02D
L1	IND, 1nH, +/-0.3nH, M/L, 0402	MURATA	LQG15HN1N0S02D
L2, L3	FER, BEAD, 1500R, 500mA, 0603	MURATA	BLM18HE152SN1D
T1, T2	BALUN, 75Ω / 75Ω	MURATA	DXW21BN7511SL07
T3	XFMR - 45-2000MHz, 75Ω	Mini-RF	MRFXF0090
J2, J3	CONN, HDR, ST, 3-PIN, 0.100"	SAMTEC INC.	TSW-103-07-G-S
J1, J4	F FEM EDGE MOUNT, 75 OHMS	Millimeter Wave Tech	MW-846-C-DD-75
N/A	HEATSINK, 50 x 50 x10	Alpha Nova Tech Inc	S08EFV05-A
C1, C5, C6, C9, C10, C11, C25, C26, L5	NOT POPULATED ITEM		DUMMY PART

BOM Changes for Downstream 8V Operation

R4	RES, 2.0K OHM, 5%, 1/16W, 0402	Kamaya	RMC1/16-202JTH
----	--------------------------------	--------	----------------

Performance Data, Downstream 5V

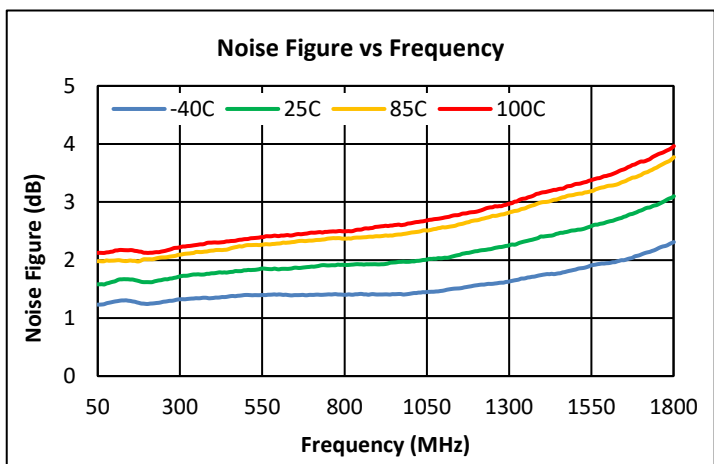
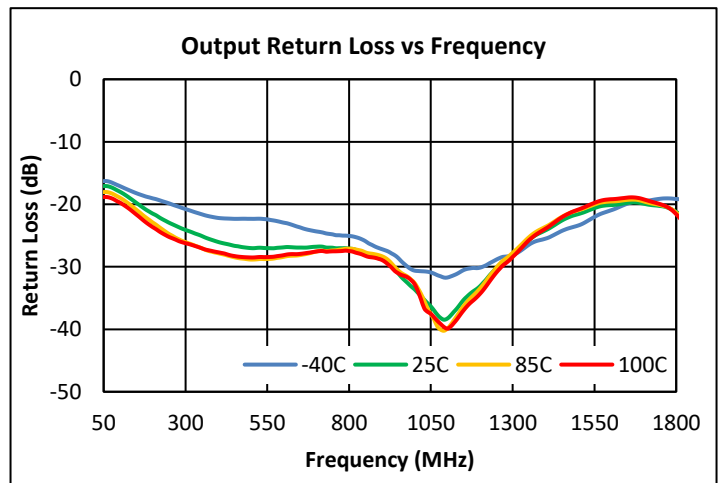
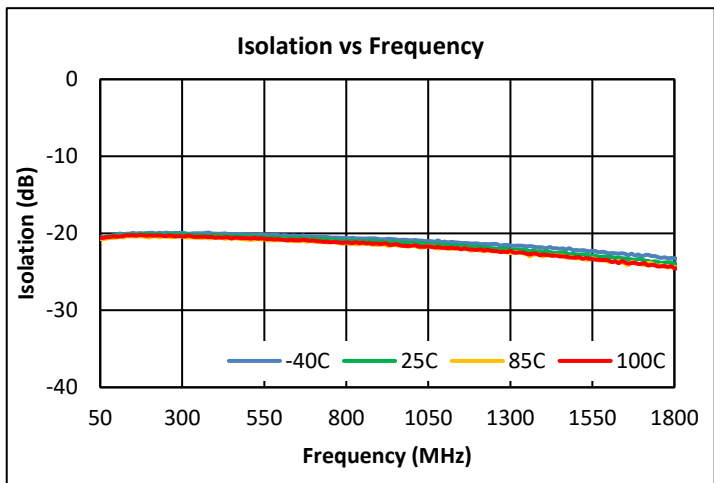
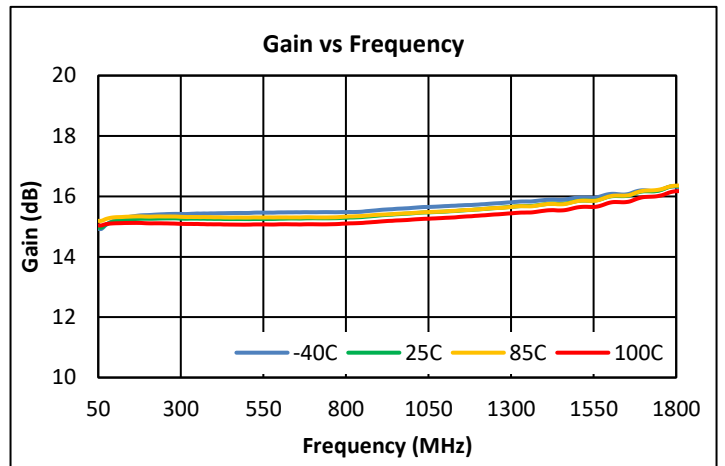
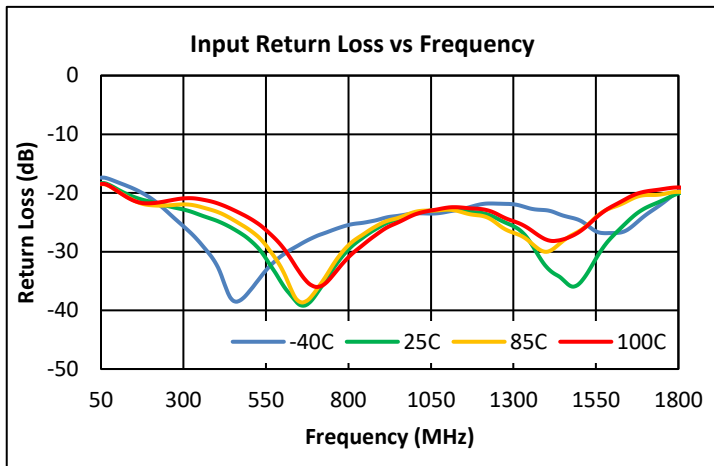

Performance Data, Downstream 5V (cont'd)

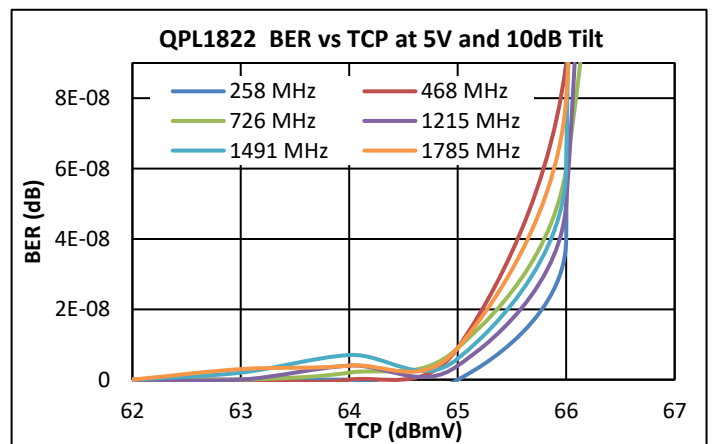
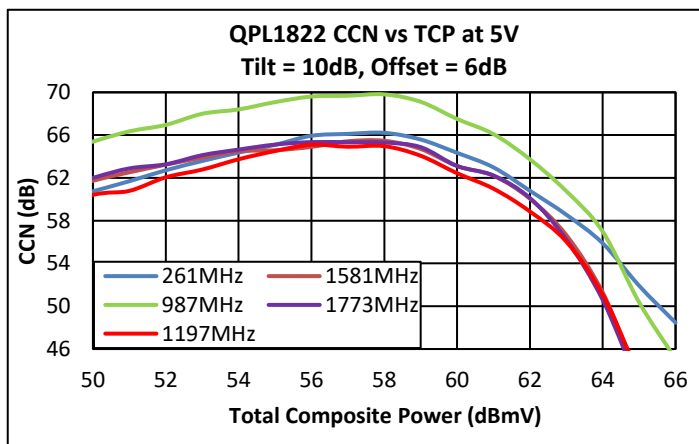
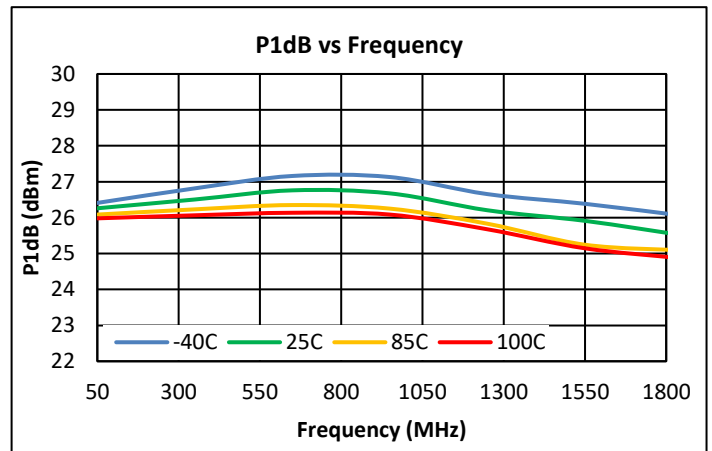
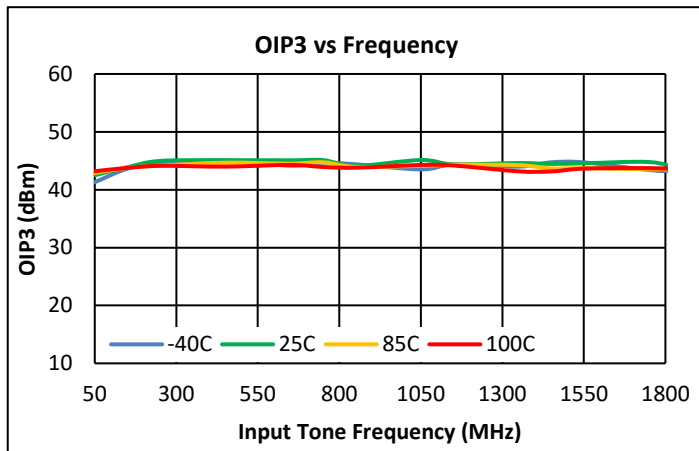
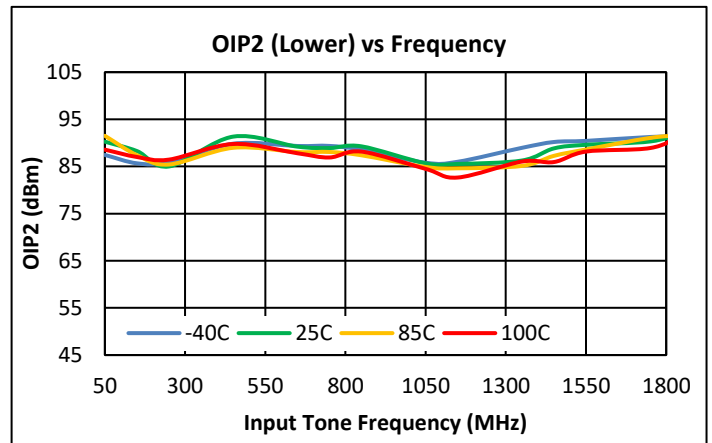
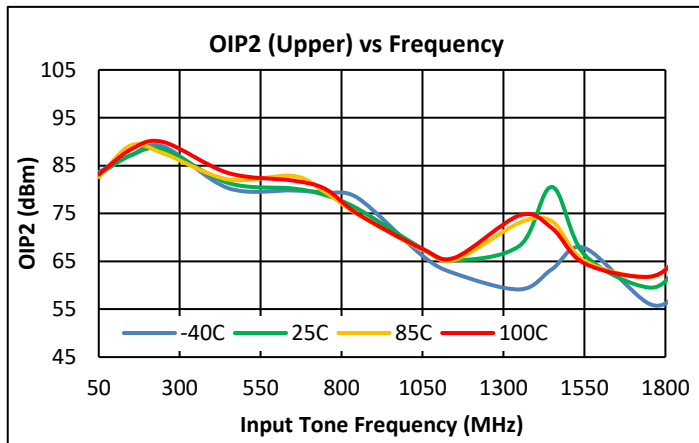

Notes:

- (1) 5V OIP2: +12dBm/tone output @ Δf = 53MHz
- (2) 5V OIP3: +12dBm / tone output @ Δf = 6MHz
- (3) CCN Test conditions: 10dB tilt, 6dB offset at 1026MHz, 255-1791MHz loading
- (4) BER Test Conditions: 255 – 1791 MHz, 280 Ch SC-QAM, 10dB tilt, 0dB offset

Performance Data, Downstream 8V

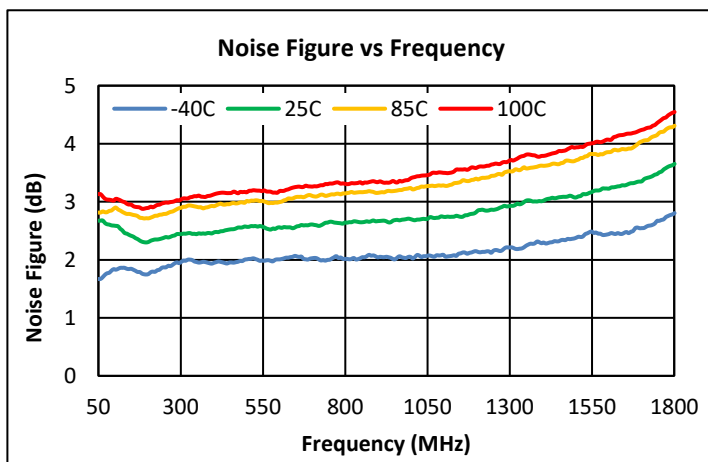
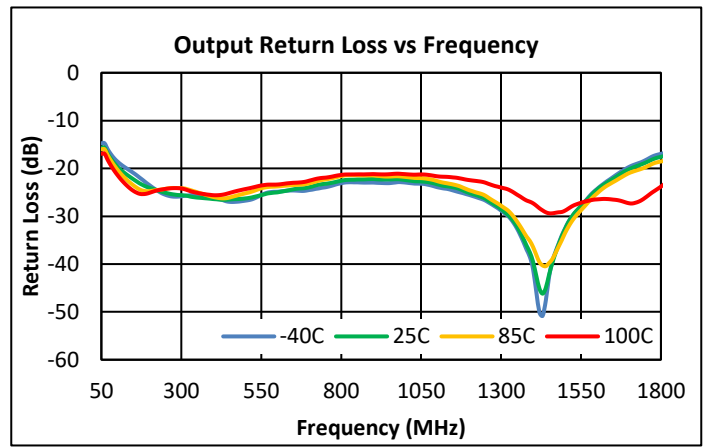
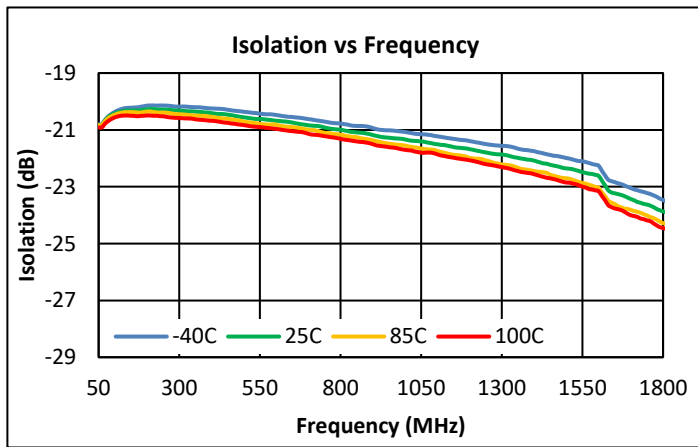
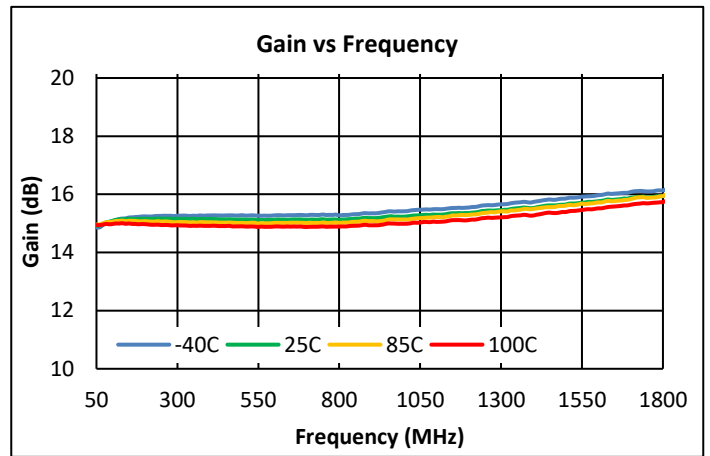
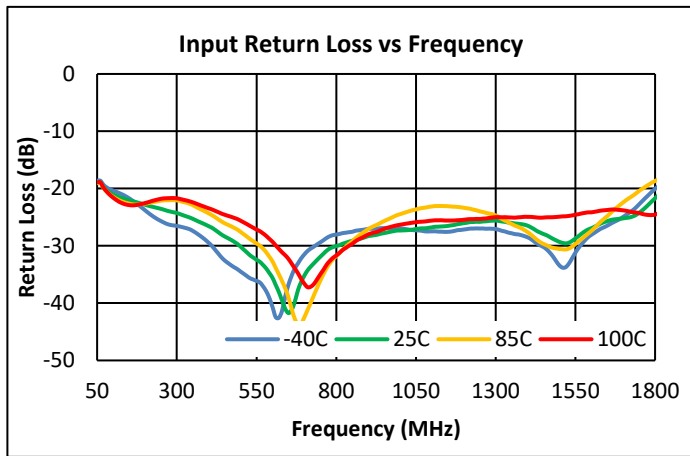

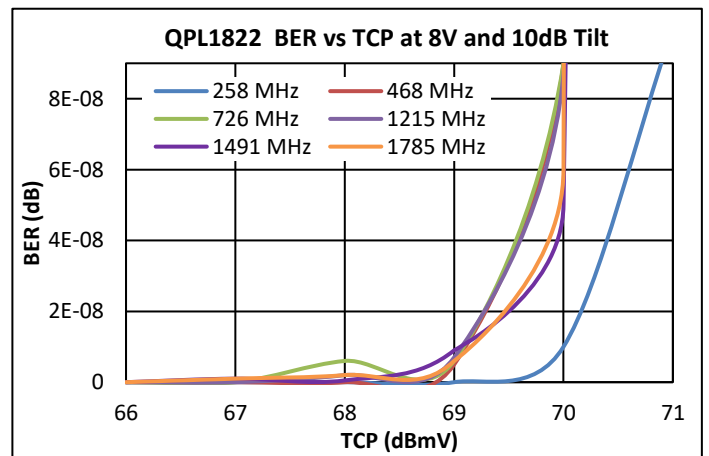
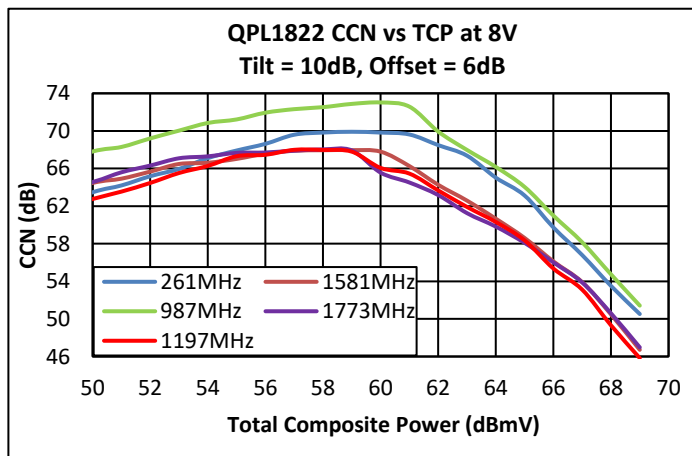
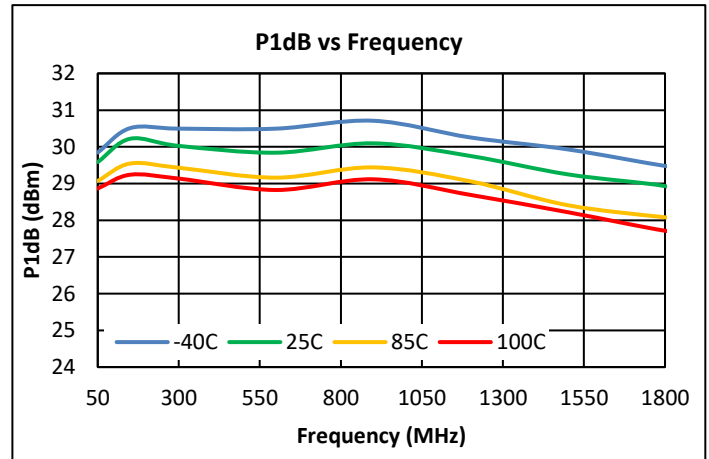
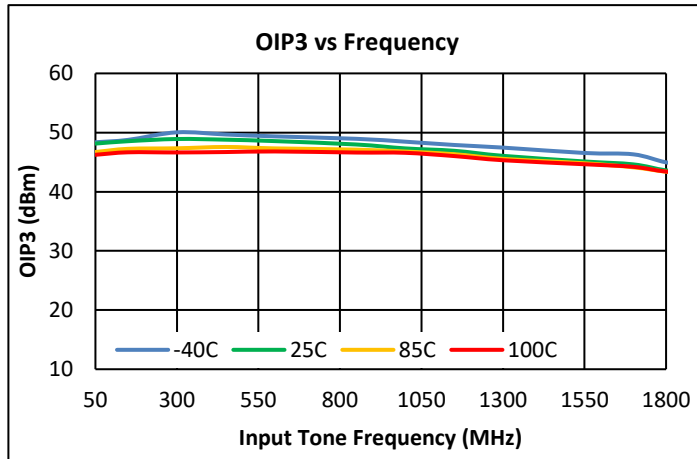
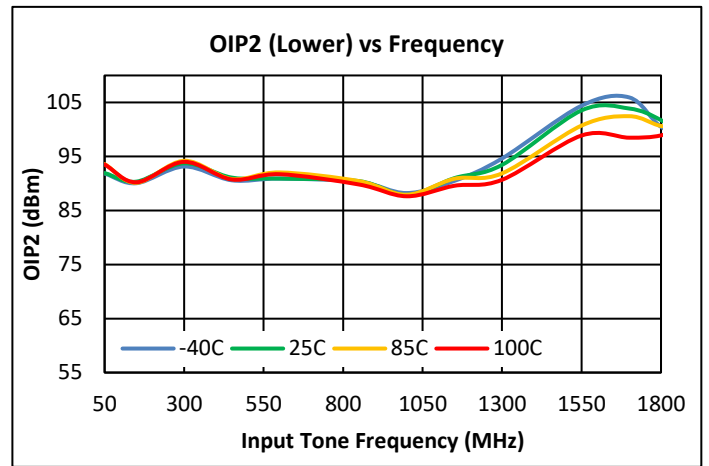
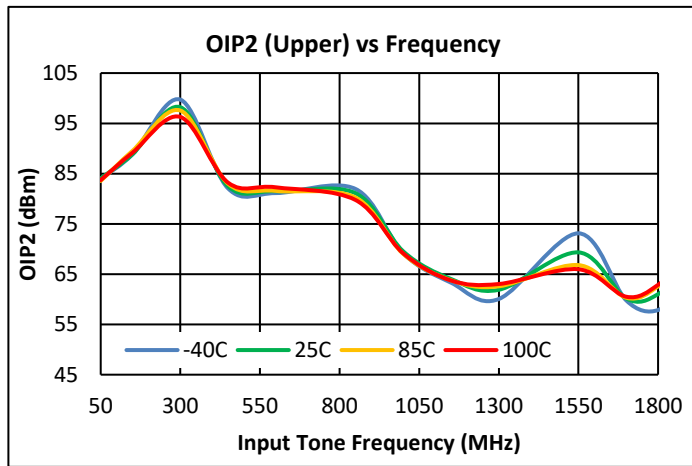
Performance Data, Downstream 8V (Cont'd)

Notes:

- (1) 8V OIP2: +12dBm/tone output @ $\Delta f = 53\text{MHz}$
- (2) 8V OIP3: +12dBm / tone output @ $\Delta f = 6\text{MHz}$
- (3) CCN Test conditions: 10dB tilt, 6dB offset at 1026MHz, 255-1791MHz loading
- (4) BER Test Conditions: 255 – 1791 MHz, 280 Ch SC-QAM, 10dB tilt, 0dB offset

IADJ Resistor Value, Downstream

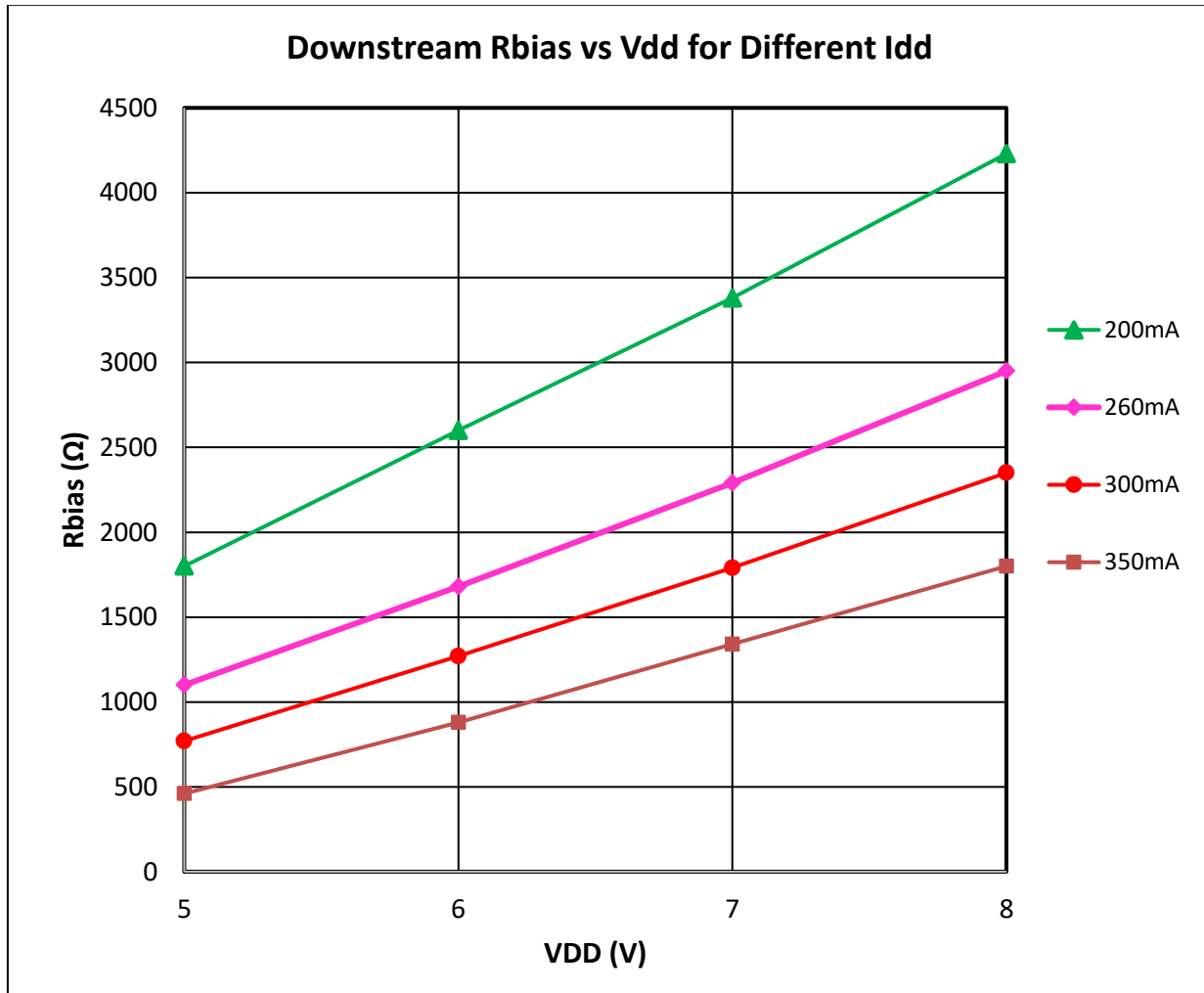
The Resistor Rbias (R4) is used to set the device current. In the application circuit, the value of Rbias is set to get an IDD of 260mA which is optimal for linearity at 5V. In applications where higher linearity is required, or higher supply rail is present, the IDD can be adjusted by varying the value of Rbias. (See graph below for downstream application)





Electrical Specifications (Upstream)

Parameter	Test Condition	Min	Typ	Max	Unit
Supply Voltage (VDD)			5/8		V
Supply Current (IDD)			260/350		mA
Frequency Range		5		700	MHz
Gain at 5 MHz			15		dB
Gain at 700 MHz			15		dB
Gain Slope			0		dB
Reverse Isolation			20		dB
Input Return Loss	5 – 700MHz		-20		dB
Output Return Loss	5 – 700MHz		-20		dB
MER	At +65.5dBmV @ 5V and +69dBmV @ 8V Total Composite Output power. 5MHz to 700MHz, 112 Ch, SC-QAM, 0dB tilt, 0dB Offset (Source corrected)		45		dB
Noise Figure	5-700MHz		2.3		dB
OIP2L	+12 dBm / tone output, Δf=53MHz, Full Band		90		dBm
OIP2U	+12 dBm / tone output, Δf=53MHz, Full Band		80		dBm
OIP3	+12 dBm / tone output, Δf=6MHz, Full Band		46/49		dBm
OP1dB	5-700MHz		26/29		dBm
Thermal Resistance	ΘJC (Junction to Device Heat Slug)		12		°C/W

Note: Typical performance at these conditions: Temp = +25 °C, V_{DD} = +5 V, 75 Ω system, Full band unless otherwise noted

Evaluation Board Schematic 5 MHz – 700 MHz (Upstream)

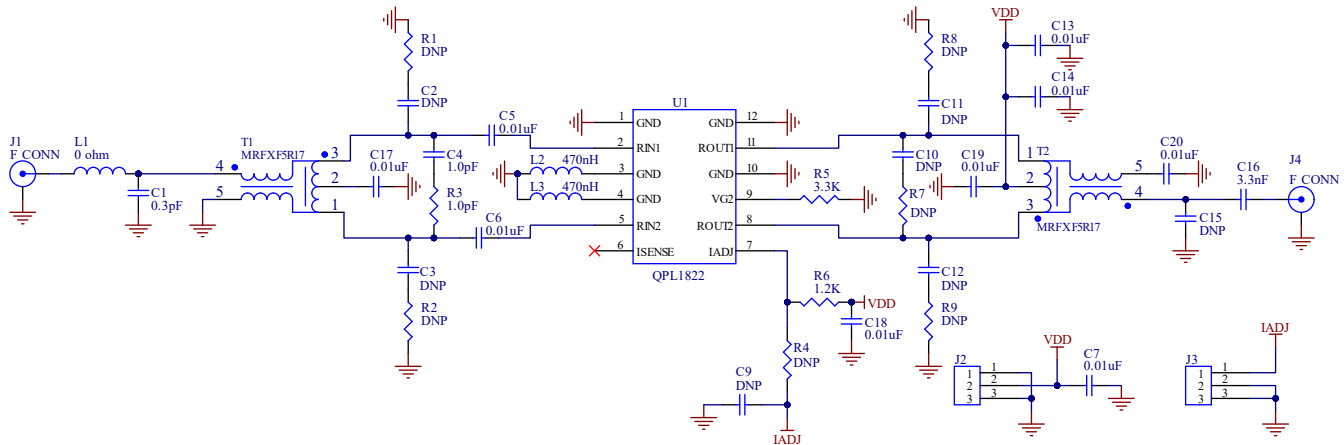

Evaluation Board Assembly Drawing (Upstream)

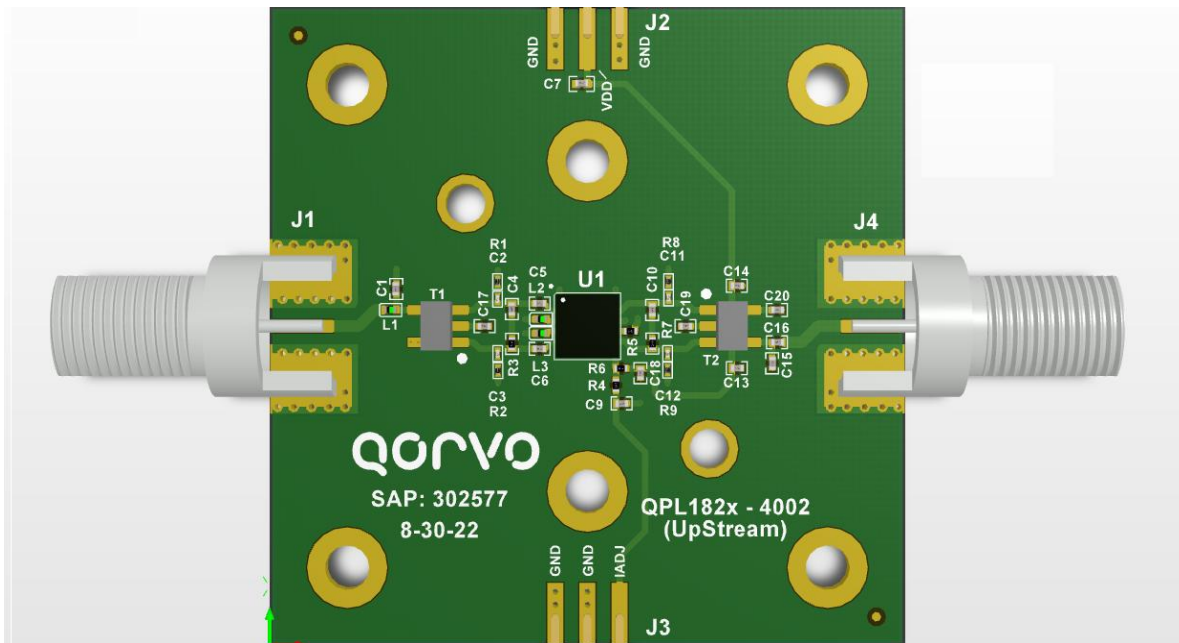

Materials: Isola370HR High-Tg FR4

Layer	Thickness	Primary Stack	Description	Dk / Df
Layer - 1	0.0010 0.0020		Taiyo 4000-HFX DI 1/2oz Mix (Std Plt)	3.50 / 0.0190
Layer - 2	0.0578 0.0020		370H 1/2oz Mix (Std Plt)	4.34 / 0.0180



Evaluation Board Bill of Materials for Upstream 5V

Ref Des	Description	Mfg Name	Mfg Part #
PCB	PCB, QPL182X-4002	Qorvo	QPL1820-4002(A)
U1	1.8GHZ 5V, PUSH PULL, 15DB GAIN	Qorvo	QPL1822
C1	CAP, 0.3pF, +/-0.1pF, 25V, 0201	MURATA	GJM0335C1ER30BB01D
C5, C6, C7, C13, C14, C17, C18, C19, C20	CAP, 0.01uF, 10%, 50V, X7R, 0402	MURATA	GCM155R71H103KA55D
C4, R3	CAP, 1pF, +/-0.05pF, 50V, 0402	MURATA	GJM1555C1H1R0WB01D
C16	CAP, 3300pF, 10%, 50V, X7R, 0402	Kemet	C0402C332K5RACTU
L1	RES, 0 OHM, 5%, 1/10W, 0402	Kamaya, Inc	RMC1/16SJPTH
R6	RES, 680 OHM, 5%, 1/16W, 0402	Kamaya, Inc	RMC1/16S-681JTH
R5	RES, 3.3K, 5%, 1/16W, 0402	Kamaya, Inc	RMC1/16S-332JTH
L2, L3	IND, 470nH, 5%, 310mA,0402	Coilcraft, Inc.	0402AF-471XJLW
T1, T2	XFMR, BALUN, 1:1, 5-700MHz,	MiniRF, Inc.	MRFXF5R17
	SCREW, M3 x 6mm, SHCS, SS	McMaster-Carr	91292A111
J2, J3	CONN, HDR, ST, 3-PIN, 0.100"	SAMTEC INC.	TSW-103-07-G-S
J1, J4	CONN, F FEM EDGE MOUNT,	Millimeter Wave	MW-846-C-DD-75
N/A	HEATSINK, 50 x 50 x10	Alpha Nova Tech	S08EFV05-A
C2, C3, C9, C10, C11, C12, C15, R1, R2, R4, R7, R8, R9	NOT POPULATED ITEM		DUMMY PART

BOM Changes for Upstream 8V Operation

R6	RES, 1.2K OHM, 1%, 1/16W, 0402	Kamaya	RMC 1/16S-122JTH
----	--------------------------------	--------	------------------

Performance Data, Upstream 5V

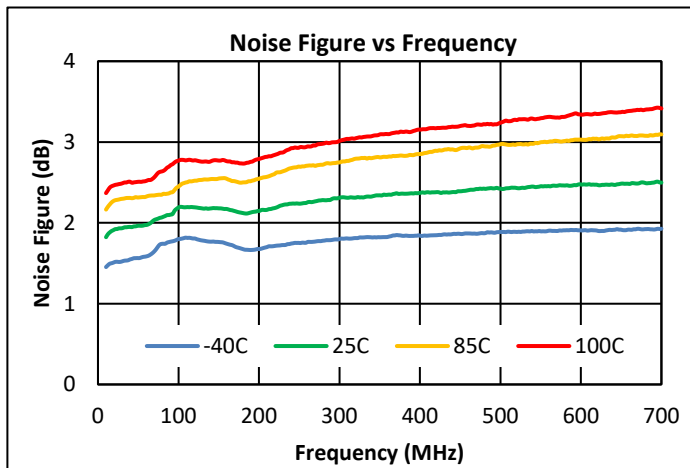
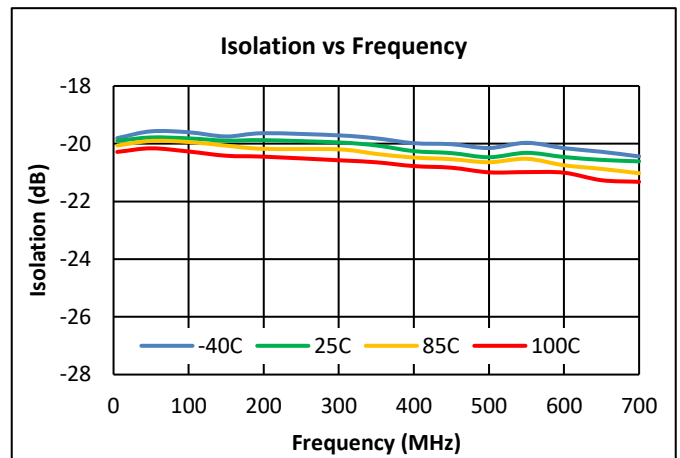
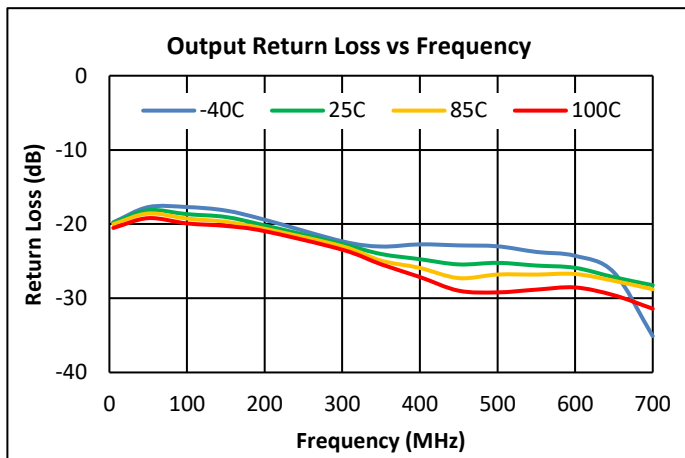
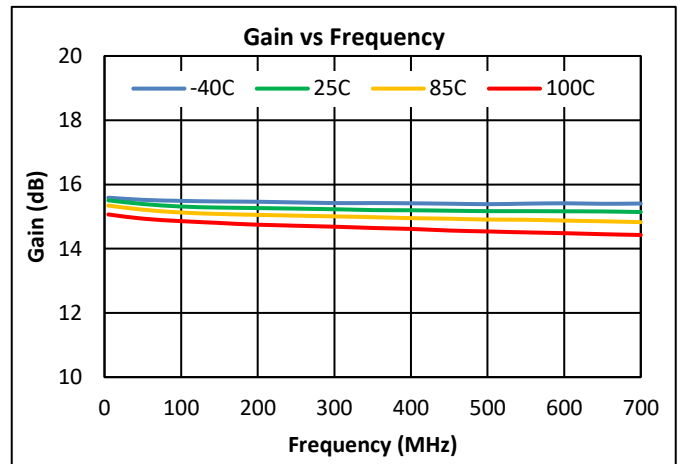
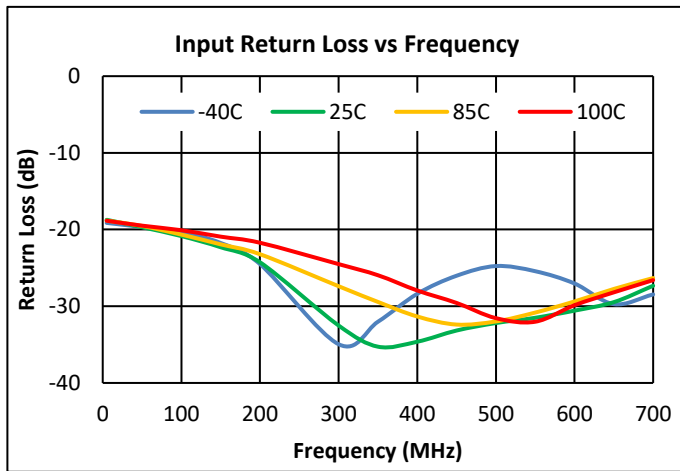

Performance Data, Upstream 5V_(Cont'd)

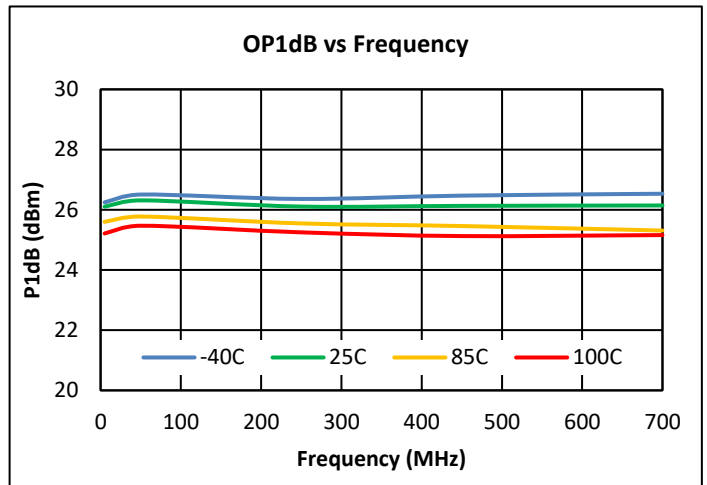
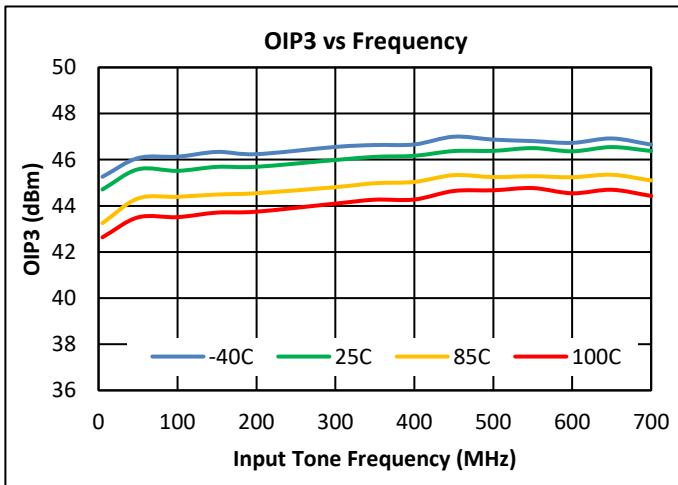
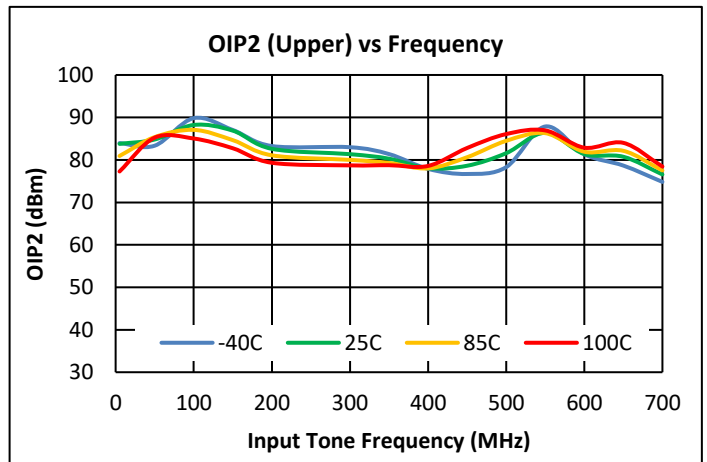
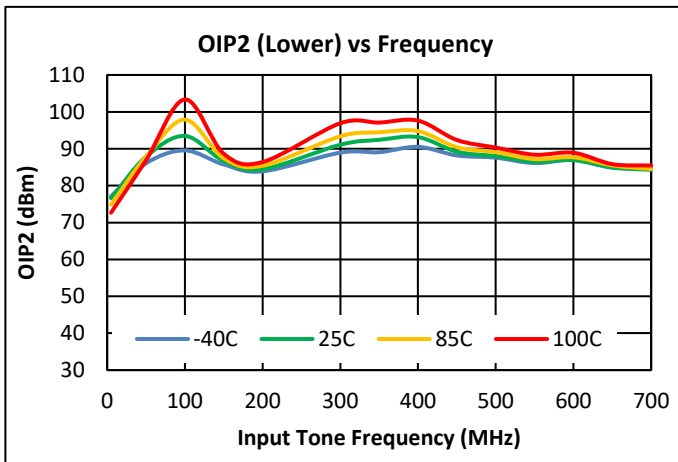

Notes:

- (1) 5V OIP2: +12dBm / tone output @ Δf = 53MHz
- (2) 5V OIP3: +12dBm / tone output @ Δf = 6MHz

Performance Data, Upstream 5V_(Cont'd)

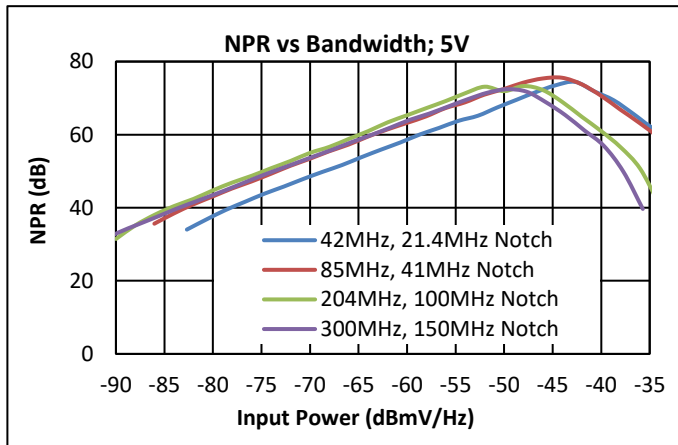
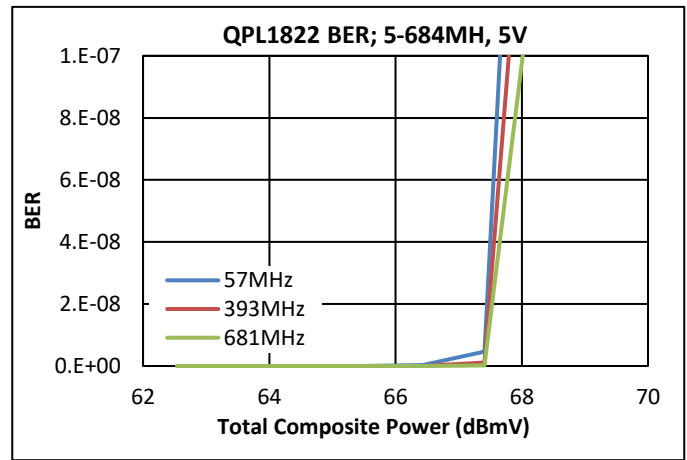
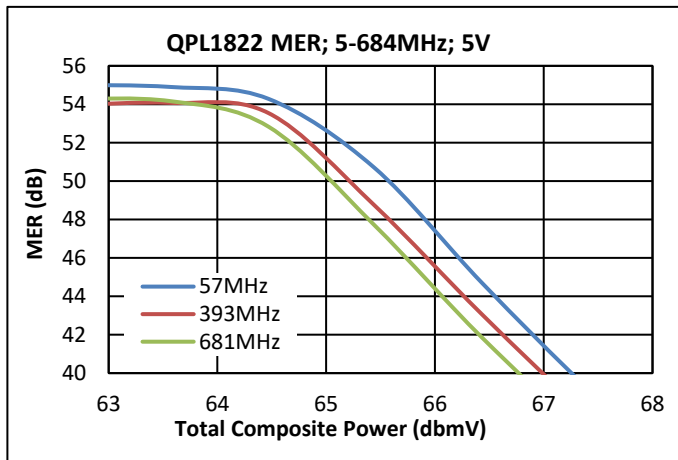

Notes:

- (1) MER & BER Test Conditions: 5 – 694MHz, 111 Ch SC-QAM, 0dB tilt
- (2) MER is source corrected

Performance Data, Upstream 8V

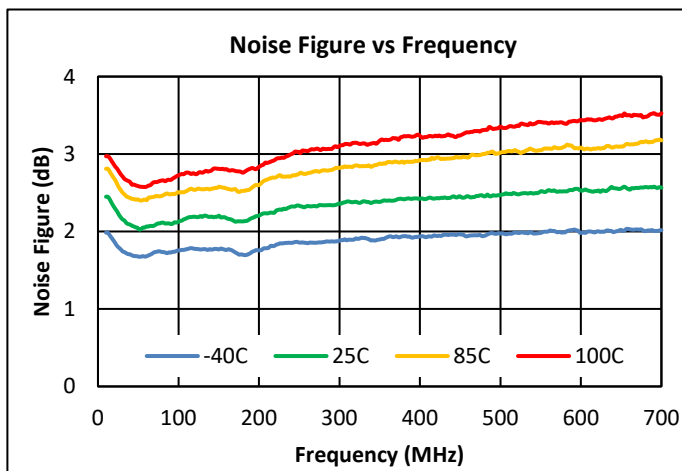
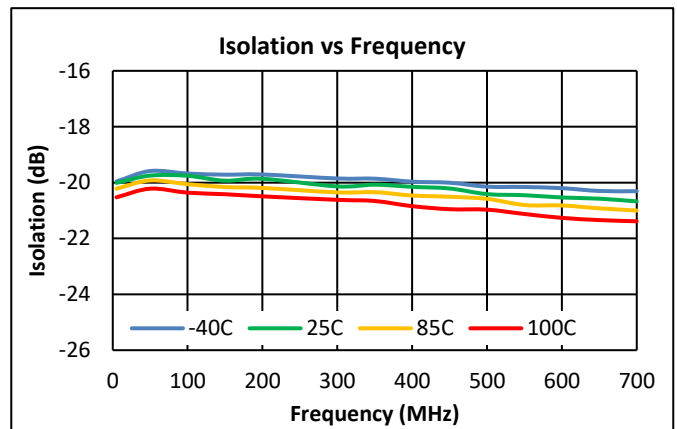
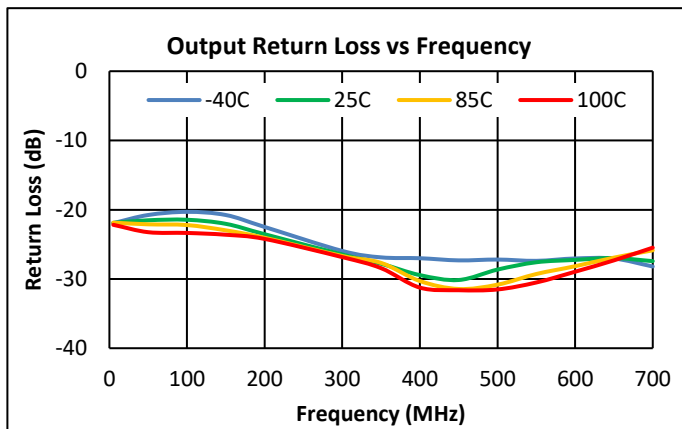
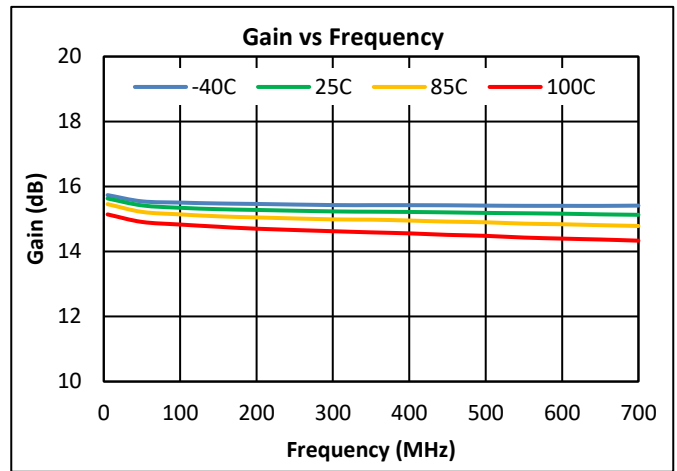
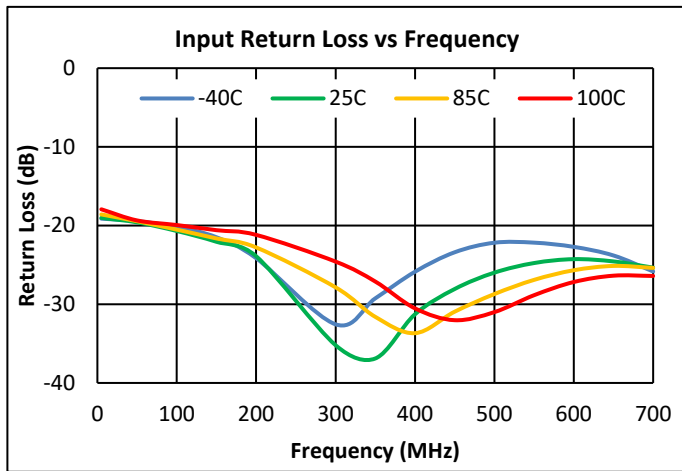

Performance Data, Upstream 8V (Cont'd)

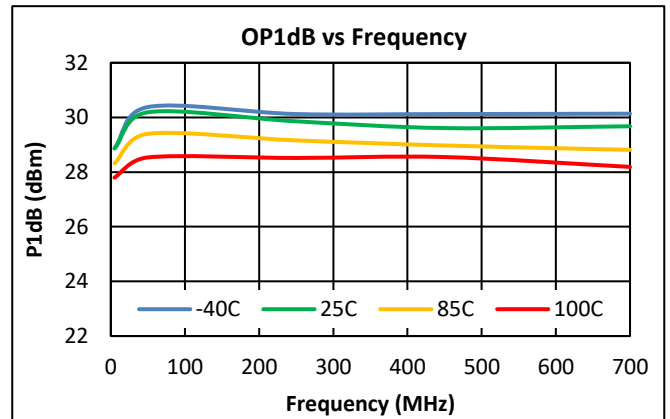
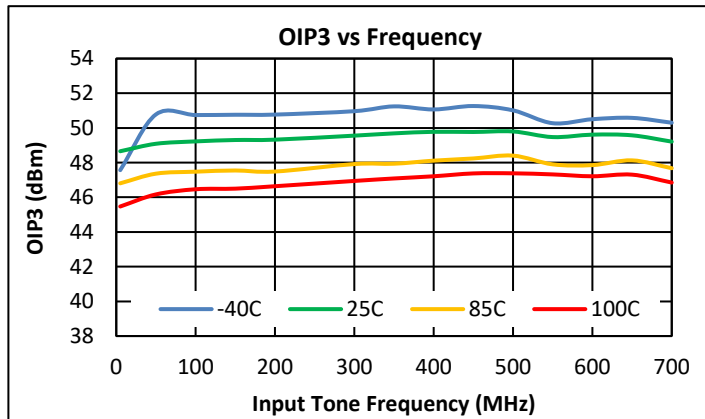
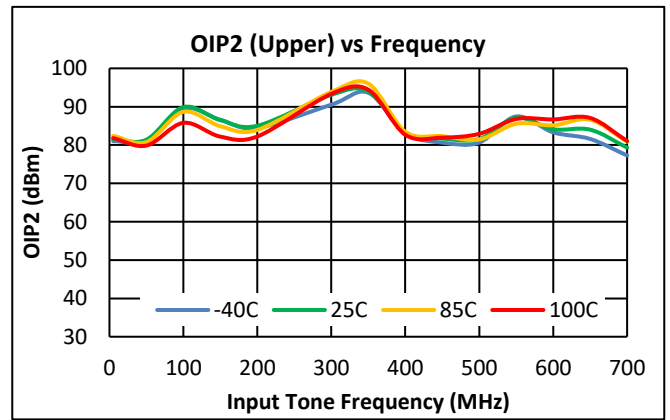
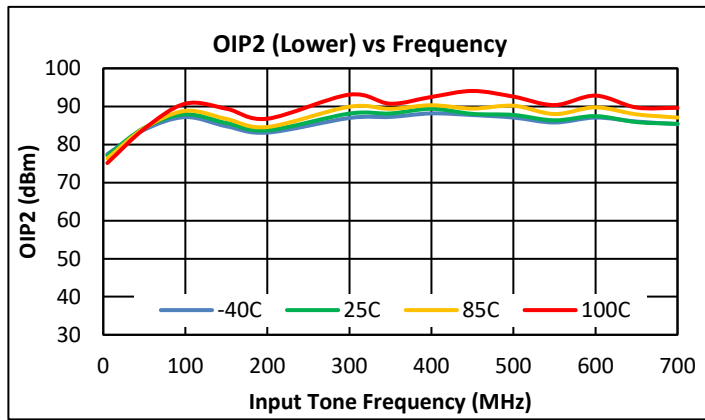

Notes:

- (1) 8V OIP2: +12dBm / tone output @ $\Delta f = 53\text{MHz}$
- (2) 8V OIP3: +12dBm/tone output @ $\Delta f = 6\text{MHz}$

Performance Data, Upstream 8V (Cont'd)

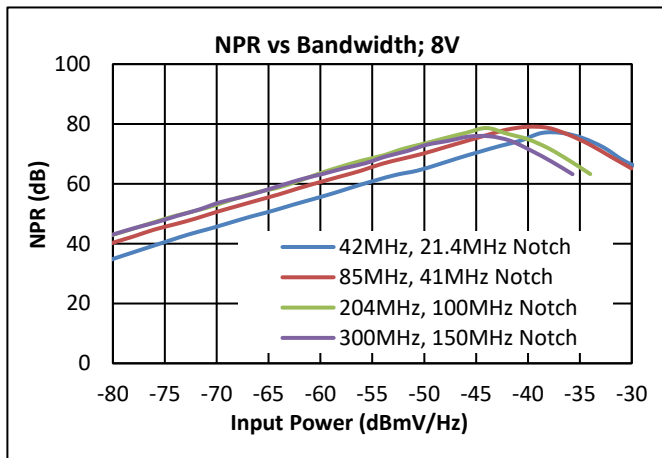
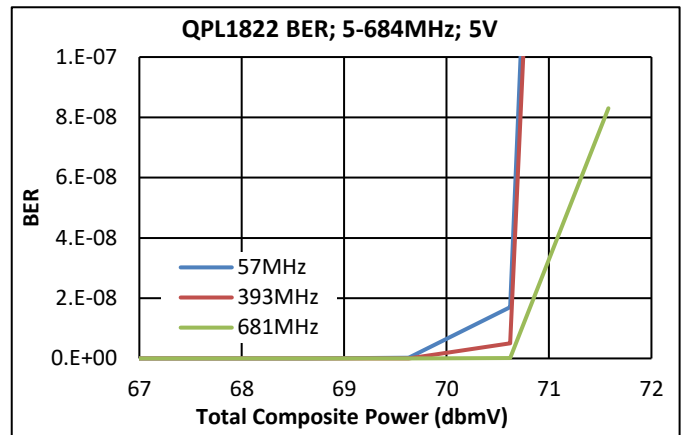
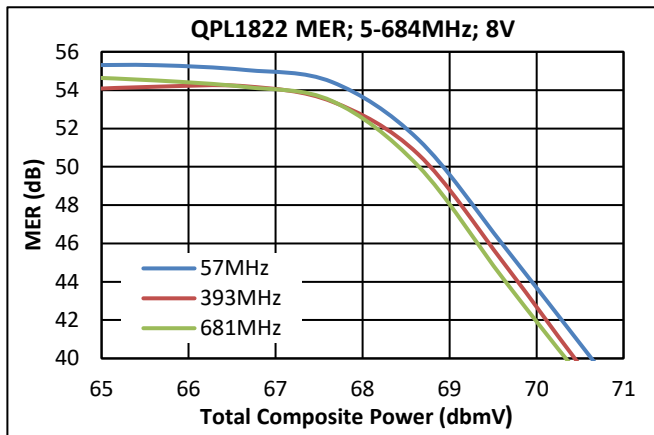

Notes:

- (1) MER & BER Test Conditions: 5 – 694 MHz, 111 Ch SC-QAM, 0dB tilt
- (2) MER is corrected

IADJ Resistor Value, Upstream

The Resistor Rbias (R6) is used to set the device current. In the application circuit, the value of Rbias is set to get an IDD of 260mA which is optimal for linearity at 5V. In applications where higher linearity is required, or higher supply rail is present, the IDD can be adjusted by varying the value of Rbias. (See graph below for downstream application)

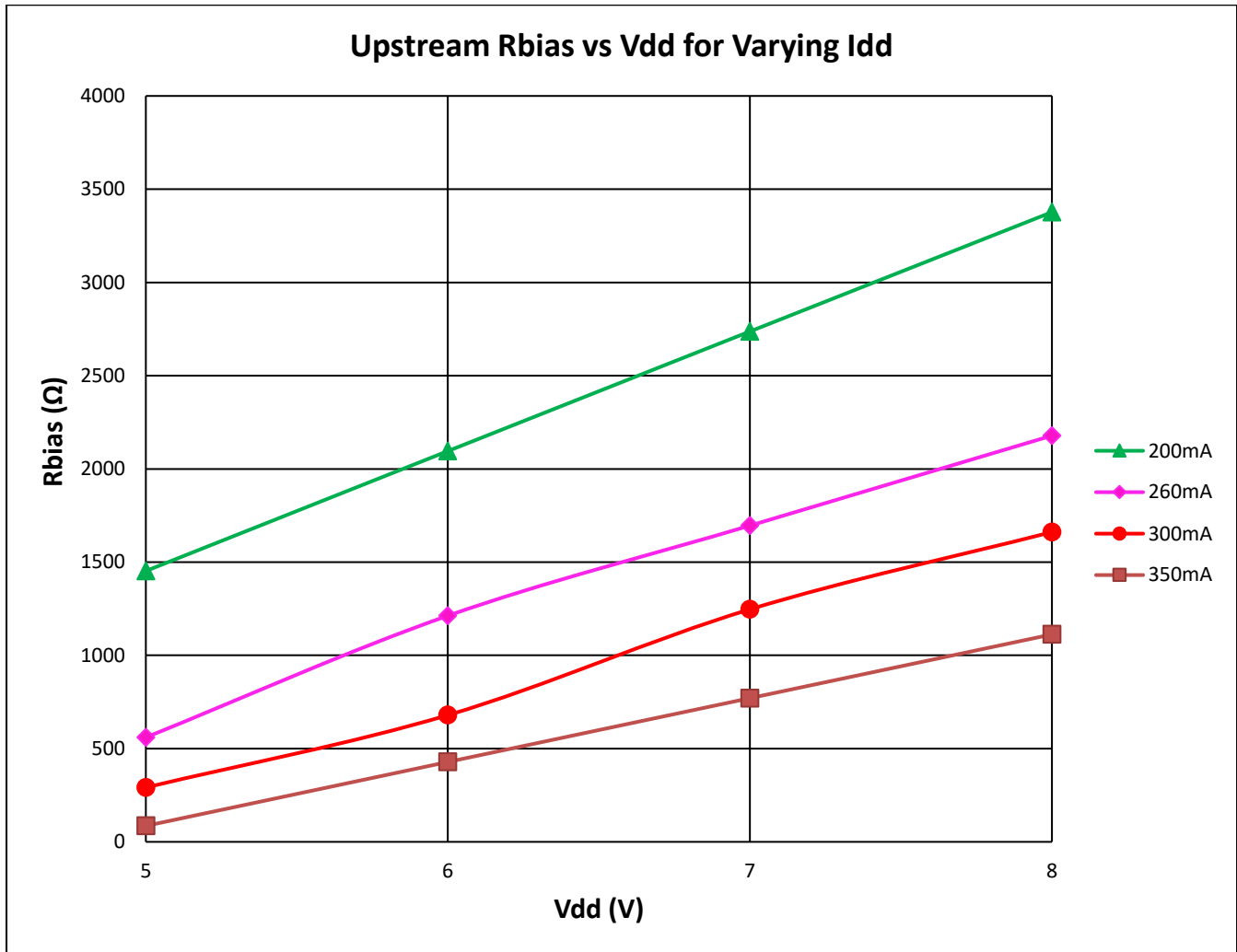

Pin Configuration and Description

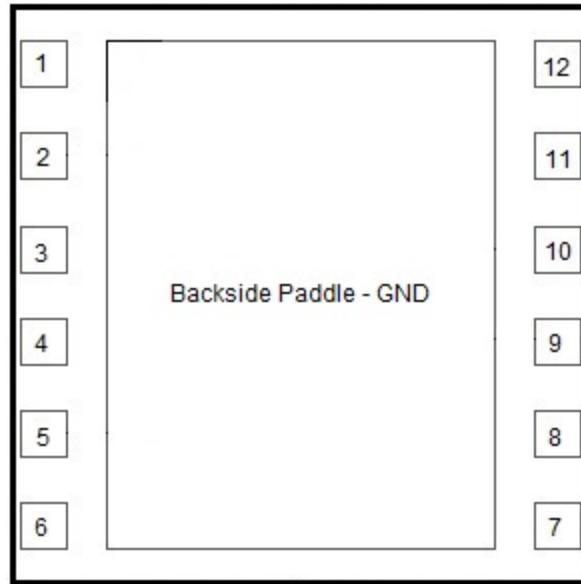

5 x 5 12-pin Laminate MCM

Pin Number	Label	Description
1	NC	No internal connection, recommended to leave open
2	RFIN+	RF Input +
3	GND	Must be connected to EVB GND
4	GND	Must be connected to EVB GND
5	RFIN-	RF input -
6	NC	No connect pin. Leave it open. Do not connect to GND.
7	IADJ	IDD current set
8	RFOUT-/VDD2	RF output - and VDD through RF Choke
9	VG2	Cascode device bias resistor divider
10	NC	No internal connection, recommended to leave open
11	RFOUT+/VDD	RF output + and VDD through RF Choke
12	NC	No internal connection, recommended to leave open
Paddle	GND	DC/RF/Thermal/GND. (Maximize vias in this area)

Package Outline

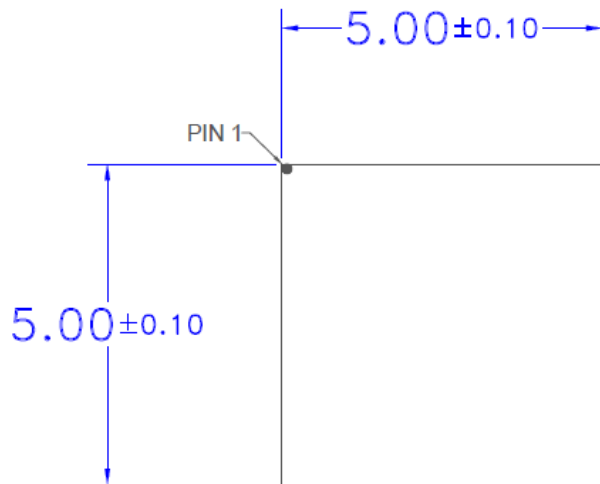

TOP VIEW

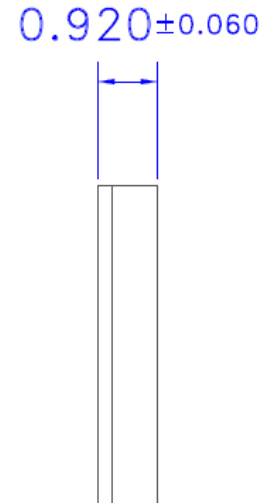

SIDE VIEW

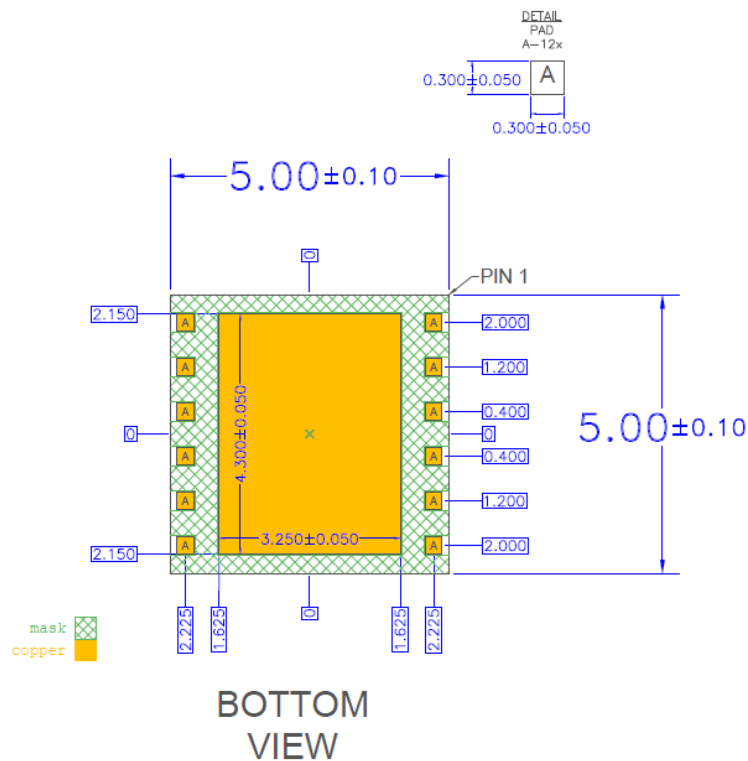

Landing Pattern

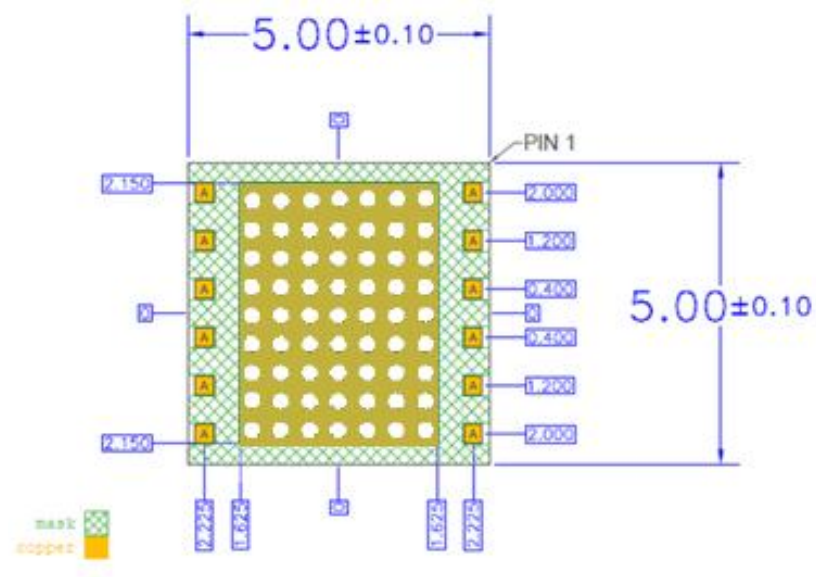
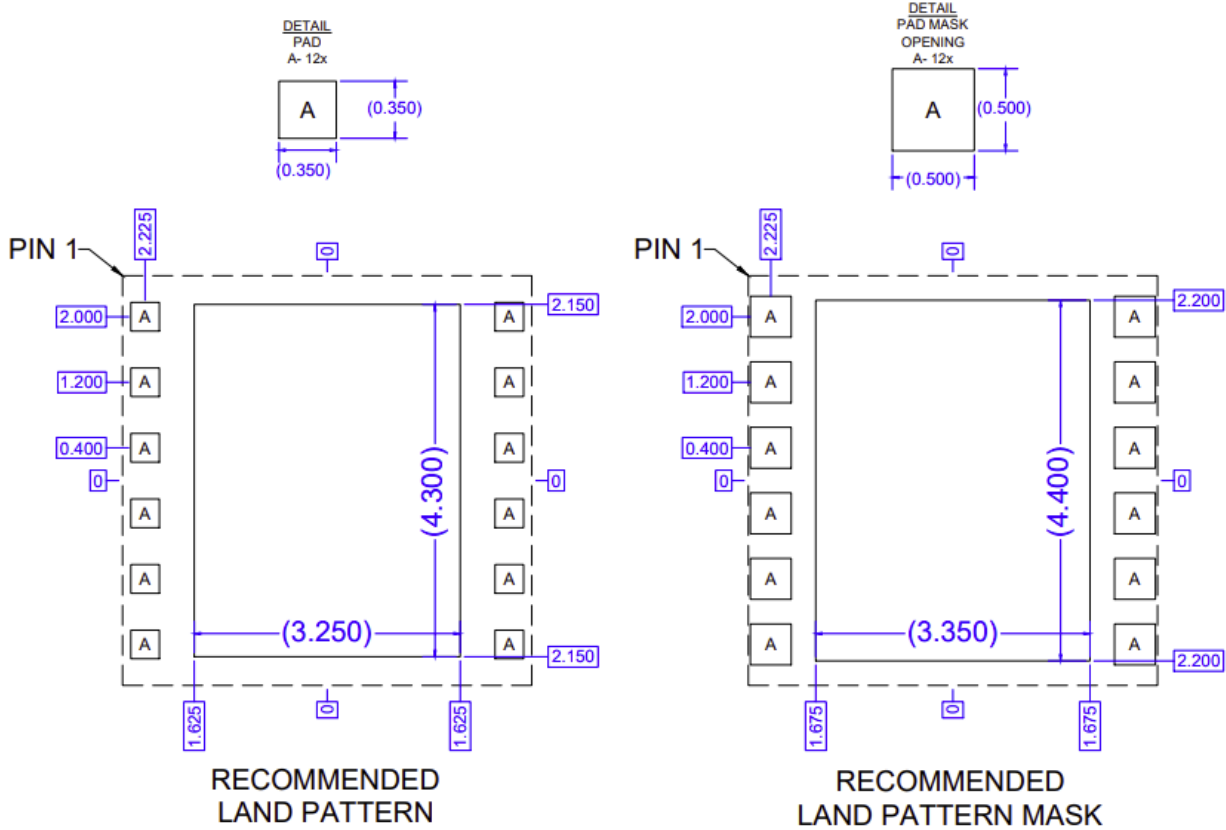

Recommended Via Pattern (63 Vias at 10mil Diameter)

Package Marking

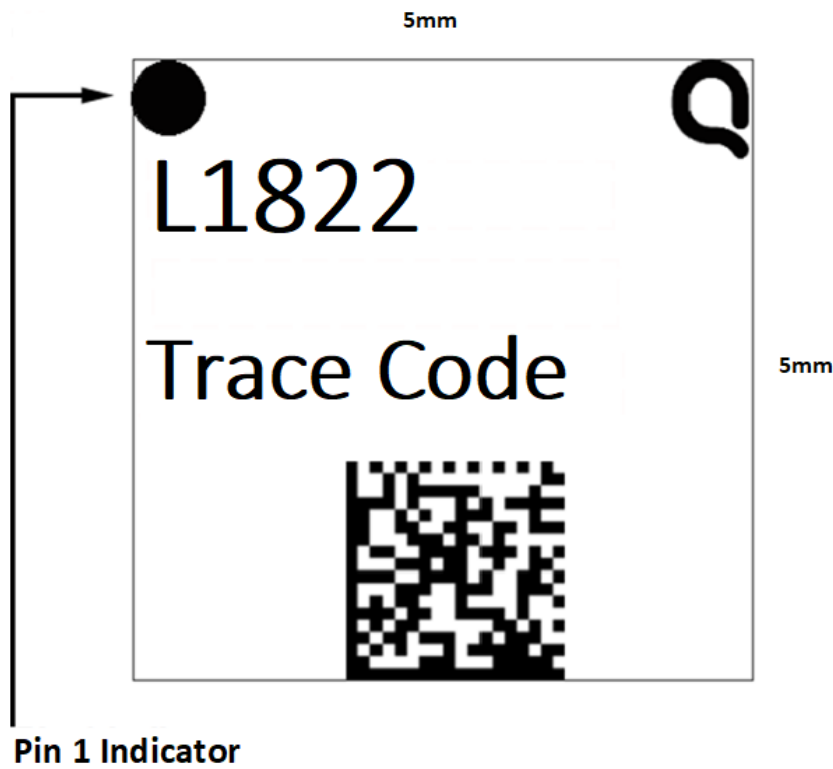

Tape and Reel

Qorvo Part Number	Reel Diameter Inch (mm)	Hub Diameter Inch (mm)	Width (mm)	Pocket Pitch (mm)	Feed	Units Per Reel
QPL1822TR13	13 (330)	4 (102)	12	8	Single	2500

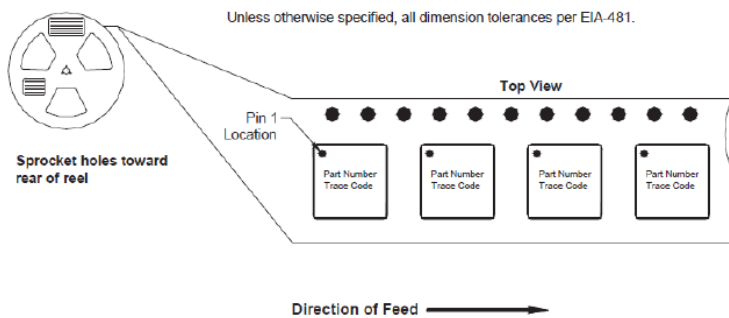



Figure 1: 5.000 mm x 5.000 mm (Carrier Tape Drawing with Part Orientation)

Handling Precautions

Parameter	Rating	Standard	 Caution! ESD Sensitive Device
ESD – Human Body Model (HBM)	Class 1B (500V to <1000V)	ANSI / ESDA / JEDEC JS-001	
ESD – Charged Device Model (CDM)	Class C3 (\geq 1000V)	ANSI / ESDA / JEDEC JS-002	
MSL – Moisture Sensitivity Level	MSL3	IPC / JEDEC J-STD-020	

Solderability

Compatible with both lead-free (260 °C max. reflow temp.) and tin / lead (245 °C max. reflow temp.) soldering processes.

Solder profiles available upon request.

Contact plating: ENEPIG

RoHS Compliance

This part is compliant with 2011/65/EU RoHS directive (Restrictions on the Use of Certain Hazardous Substances in Electrical and Electronic Equipment) as amended by Directive 2015/863/EU.

This product also has the following attributes:

- PFOS Free
- Halogen Free (Chlorine, Bromine)
- Antimony Free
- TBBP-A (C₁₅H₁₂Br₄O₂) Free
- SVHC Free

Contact Information

For the latest specifications, additional product information, worldwide sales and distribution locations:

Tel: 1-844-890-8163

Web: www.qorvo.com

Email: customer.support@qorvo.com



QPL1822

75 Ω 15 dB CATV Amplifier (5 – 1800MHz)

Important Notice

The information contained herein is believed to be reliable; however, Qorvo makes no warranties regarding the information contained herein and assumes no responsibility or liability whatsoever for the use of the information contained herein. All information contained herein is subject to change without notice. Customers should obtain and verify the latest relevant information before placing orders for Qorvo products. The information contained herein or any use of such information does not grant, explicitly or implicitly, to any party any patent rights, licenses, or any other intellectual property rights, whether with regard to such information itself or anything described by such information. **THIS INFORMATION DOES NOT CONSTITUTE A WARRANTY WITH RESPECT TO THE PRODUCTS DESCRIBED HEREIN, AND QORVO HEREBY DISCLAIMS ANY AND ALL WARRANTIES WITH RESPECT TO SUCH PRODUCTS WHETHER EXPRESS OR IMPLIED BY LAW, COURSE OF DEALING, COURSE OF PERFORMANCE, USAGE OF TRADE OR OTHERWISE, INCLUDING THE IMPLIED WARRANTIES OF MERCHANTABILITY AND FITNESS FOR A PARTICULAR PURPOSE.**

Without limiting the generality of the foregoing, Qorvo products are not warranted or authorized for use as critical components in medical, life-saving, or life-sustaining applications, or other applications where a failure would reasonably be expected to cause severe personal injury or death.

Copyright 2025 © Qorvo, Inc. | Qorvo is a registered trademark of Qorvo, Inc.

Looking for pricing, stock, or lifecycle information?

Click below to explore more details on WIN SOURCE:

 [View QPL1822TR13 on WIN SOURCE](#)

 [Qorvo US Inc. Information](#)

Optimize Your Supply Chain with WIN SOURCE Solutions

-  Global Sourcing Solution
-  Obsolete Management
-  Cost Control Management
-  Shortage Management
-  Alternative Solution
-  Excess Inventory Management