

Device Features

- OIP3 = 37.0 dBm @ 900 MHz
- Gain = 17.1 dB @ 900 MHz
- Output P1 dB = 20.9 dBm @ 900 MHz
- Typical 3.0dB NF at 900MHz
- Patented temperature compensation
- RoHS2-compliant SOT-89 SMT package



Product Description

BeRex's BG12B is a high performance InGaP/ GaAs HBT MMIC amplifier, internally matched to 50 Ohms and uses a patented **temperature compensation** circuit to provide stable current over the operating temperature range without the need for external components. The BG12B is designed for high linearity gain block applications that require excellent gain flatness. It is packaged in a RoHS2-compliant with SOT-89 surface mount package.

Applications

- Base station Infrastructure/RFID
- Commercial/Industrial/Military wireless system

Applications Circuit

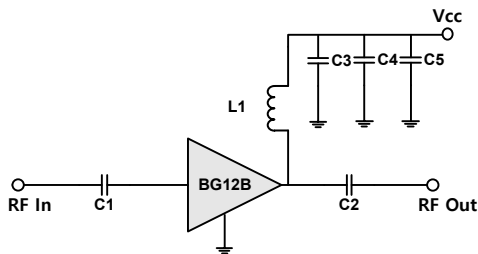

*C1, C2, C3 = 100 pF ± 5%, C4 = 1000pF ± 5%, C5 = 10uF, L1 = 100nH ±5%

*39nH or higher value L1 improves RF performance at under 3GHz.

*Optimum value of L1 may vary with board design.

(L1:100nH, C1&C2:1.2nF for 70MHz)

Electrical Specifications

Device performance _ measured on a BeRex evaluation board at 25°C, Vc=5V, 50 Ω system.

Parameter	Conditions	Min	Typ	Max	Unit
Operational Frequency Range		50		4000	MHz
Test Frequency			900		MHz
Gain		15.6	17.1		dB
Input Return Loss			-18.3		dB
Output Return Loss			-14.4		dB
Output IP3	5 dBm / tone , Δf=1 MHz	34.0	37.0		dBm
Output P1dB		19.9	20.9		dBm
Noise Figure			2.9		dB

Recommended Operating Conditions

Parameter	Min	Typ	Max	Unit
Bandwidth	50		4000	MHz
I _c @ (V _c = 5V)	62	77	92	mA
V _c	4.0	5	5.25	V
dG/dT		-0.003		dB/°C
R _{TH}		50.5		°C/W
Operating Case Temperature	-40		+85	°C

Electrical specifications are measured at specified test conditions.

Specifications are not guaranteed over all recommended operating conditions.

Absolute Maximum Ratings

Parameter	Rating	Unit
Storage Temperature	-55 to +155	°C
Junction Temperature	+170	°C
Supply Voltage	+6.0	V
Supply Current	120	mA
Input RF Power	23	dBm

Operation of this device above any of these parameters may result in permanent damage.

50-4000 MHz Cascadable InGaP HBT Gain Block

Typical Performance ($V_c = 5V$, $I_c = 77mA$, $T = 25^\circ C$)

Freq	MHz	70	500	900	1900	2140	2450	3000
S21	dB	18.6	17.5	17.1	15.0	14.6	13.9	12.4
S11	dB	16.3	18.3	17.8	19.5	20.0	17.4	9.3
S22	dB	14.6	14.4	14.4	15.0	16.6	20.5	15.8
P1	dBm	20.1	20.6	20.9	20.0	19.2	18.3	16.9
OIP3	dBm	36.5	38.0	37.0	34.5	34.0	33.0	31.0
NF	dB	2.8	3.0	2.9	3.1	3.2	3.2	3.3

Typical Performance ($V_c = 4.7 V$, $I_c = 65mA$, $T_a = 25^\circ C$)

Freq	MHz	70	500	900	1900	2140	2450	3000
S21	dB	18.6	17.5	17.1	15.0	14.5	13.8	12.4
S11	dB	16.4	18.8	18.2	19.7	20.0	17.3	9.3
S22	dB	14.8	14.5	14.5	14.8	16.3	20.0	16.1
P1	dBm	18.9	19.3	19.5	18.8	18.4	17.6	16.4
OIP3	dBm	36.0	36.0	35.0	32.5	33.0	32.0	30.5
NF	dB	2.7	2.9	2.8	3.0	3.1	3.1	3.2

Typical Performance ($V_c = 4.5 V$, $I_c = 58mA$, $T_a = 25^\circ C$)

Freq	MHz	70	500	900	1900	2140	2450	3000
S21	dB	18.5	17.4	17.0	14.9	14.5	13.8	12.3
S11	dB	16.6	19.2	18.5	19.8	20.0	17.2	9.2
S22	dB	15.0	14.6	14.5	14.7	16.2	19.7	16.4
P1	dBm	18.0	18.3	18.5	18.1	17.8	17.0	16.0
OIP3	dBm	35.0	34.5	34.0	30.5	32.0	31.0	29.5
NF	dB	2.6	2.9	2.8	3.0	3.0	3.1	3.2

Typical Performance ($V_c = 4 V$, $I_c = 41mA$, $T_a = 25^\circ C$)

Freq	MHz	70	500	900	1900	2140	2450	3000
S21	dB	18.2	17.1	16.8	14.7	14.3	13.6	12.2
S11	dB	17.1	21.3	19.8	20.5	20.1	16.7	9.0
S22	dB	15.5	15.0	14.7	14.4	15.7	18.8	17.3
P1	dBm	16.0	15.7	16.3	15.3	15.9	14.9	14.7
OIP3	dBm	30.0	29.5	29.0	28.0	28.5	27.0	27.0
NF	dB	2.5	2.8	2.7	2.8	2.9	3.0	3.0

V-I Characteristics

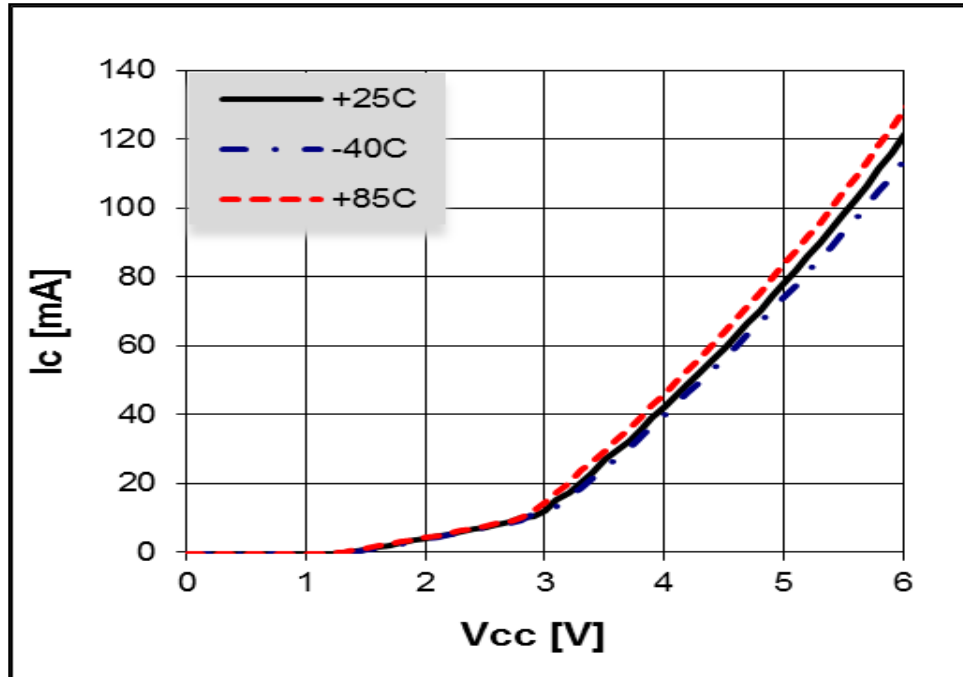

BeRex SOT89 Evaluation Board

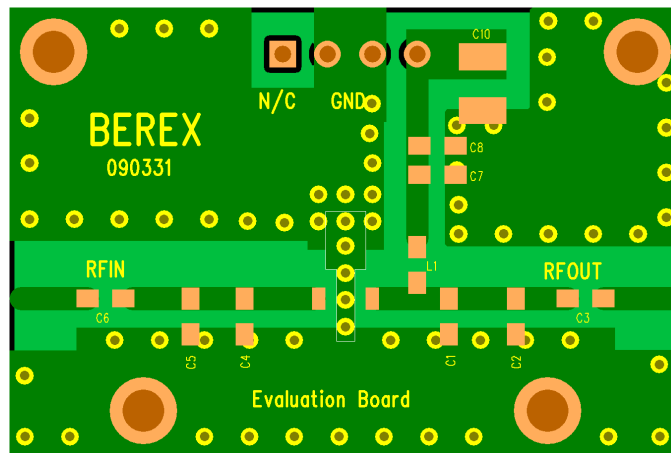

*Dielectric constant_ 4.2 *RF pattern width 52mil *31mil thick FR4 PCB

Typical Device Data

S-parameters (Vc=5V, Ic=77mA, T=25°C)

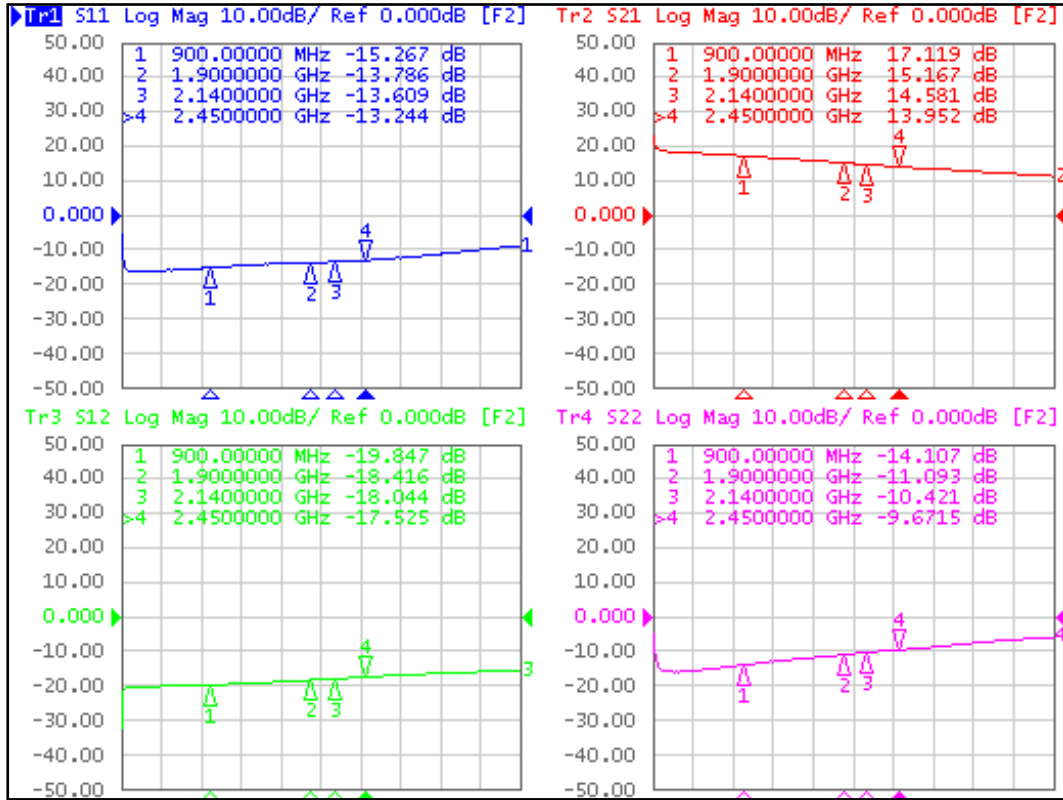

S-Parameter

(Vdevice = 5.0V, Icc = 77mA, T = 25 °C, calibrated to device leads)

Freq [MHz]	S11 Mag	S11 Ang	S21 Mag	S21 Ang	S12 Mag	S12 Ang	S22 Mag	S22 Ang
100	0.435	-93.440	7.978	-161.916	0.087	37.728	0.265	168.924
500	0.143	166.000	7.808	118.617	0.097	-30.484	0.145	161.418
1000	0.125	90.075	7.087	50.486	0.101	-76.169	0.196	122.597
1500	0.121	35.562	6.289	-12.945	0.109	-120.275	0.208	69.413
2000	0.102	1.254	5.602	-74.986	0.118	-166.758	0.174	11.788
2500	0.150	-1.546	4.918	-137.711	0.125	143.157	0.089	-40.867
3000	0.334	-42.980	4.257	152.163	0.131	84.389	0.157	101.131
3500	0.521	-144.348	1.518	123.642	0.055	64.369	0.549	-41.536
4000	0.329	161.663	3.092	61.699	0.130	9.397	0.186	143.069

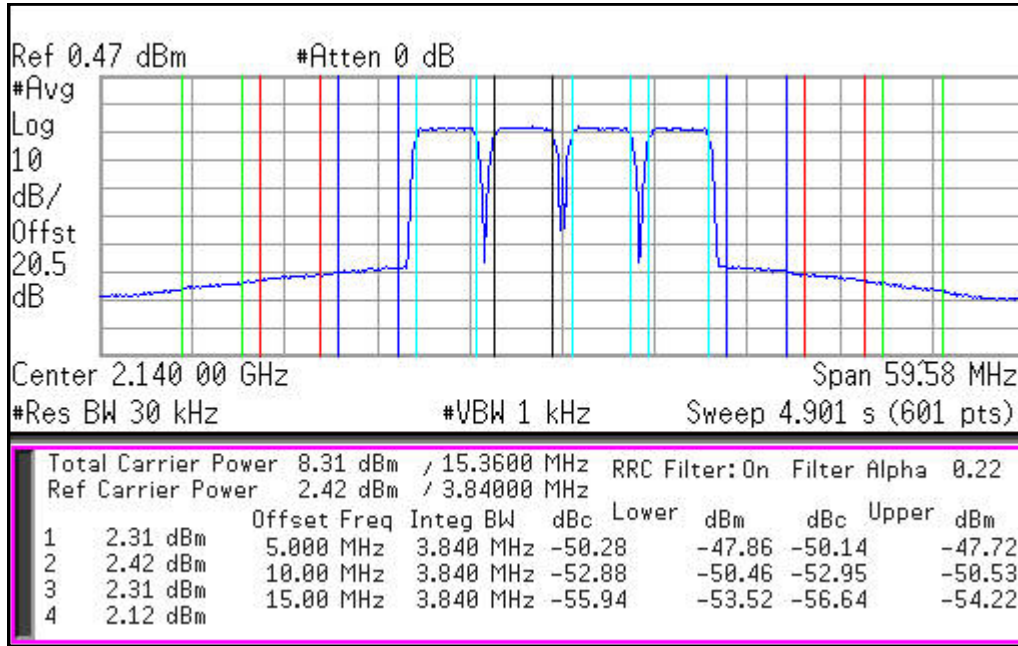
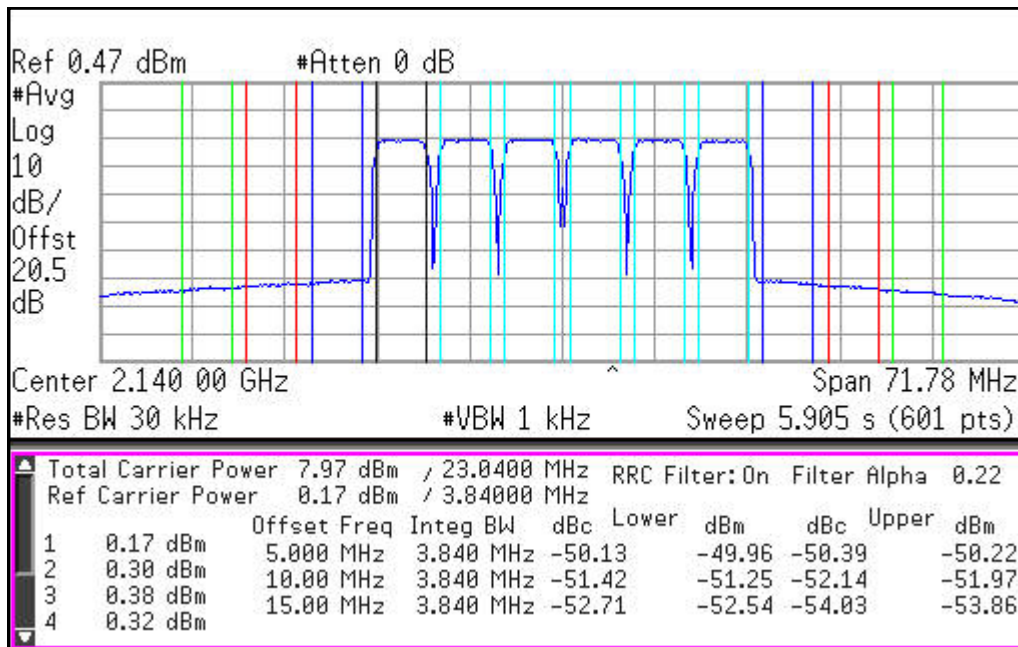
WCDMA 4FA 2140 -50dBc

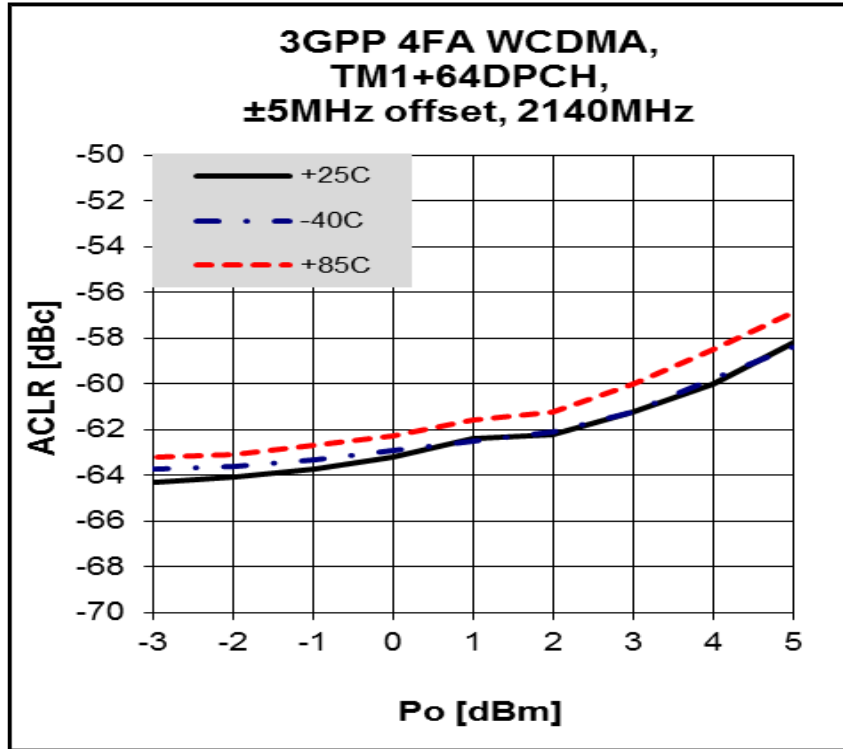
WCDMA 6FA 2140 -50dBc

ACLR

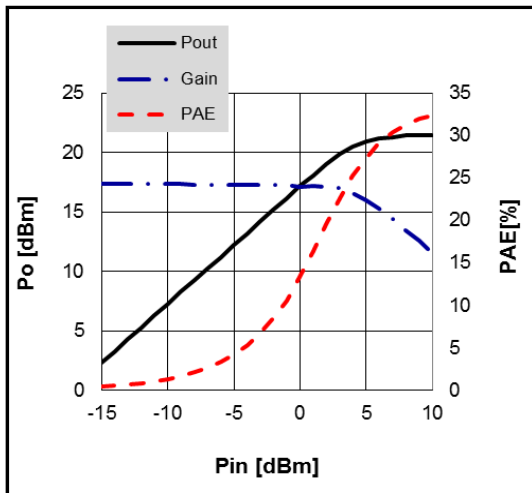
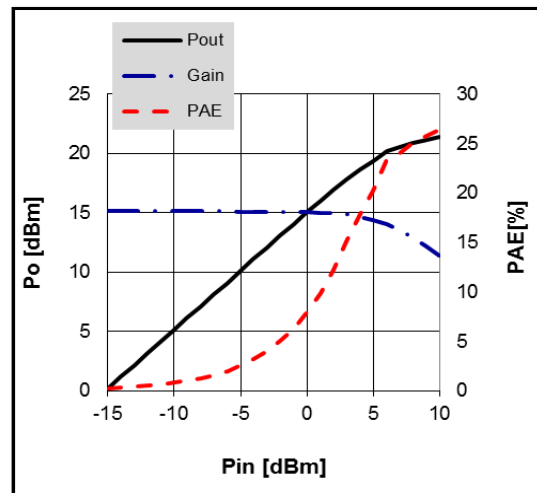
Typical Performance

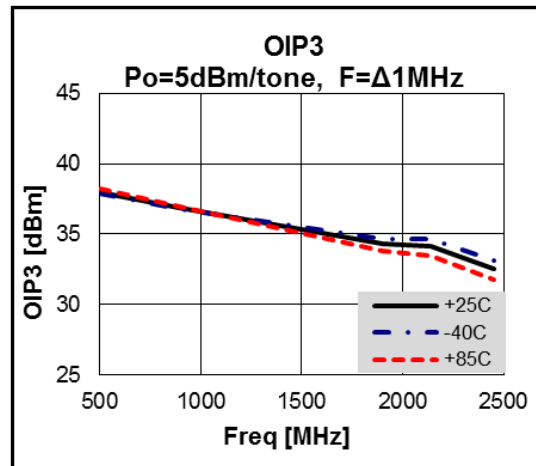
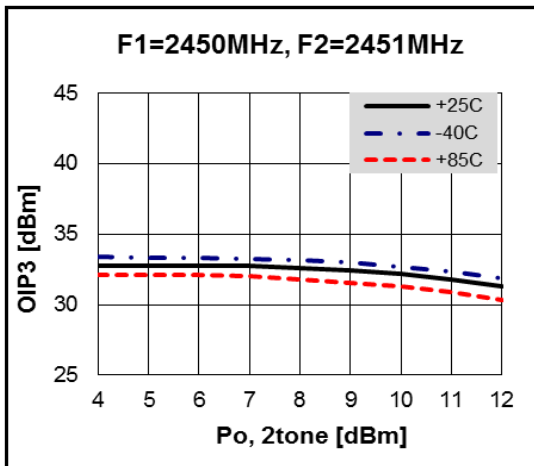
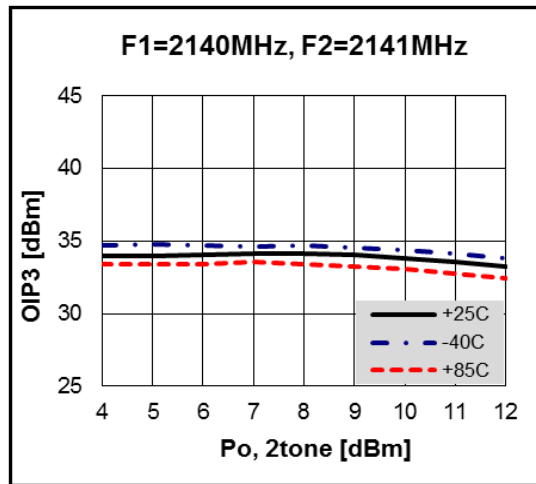
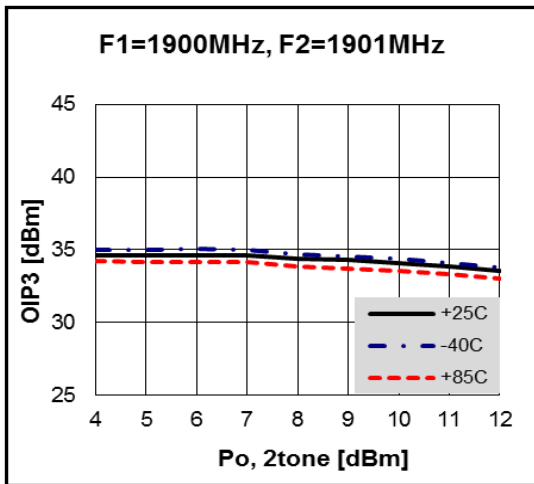
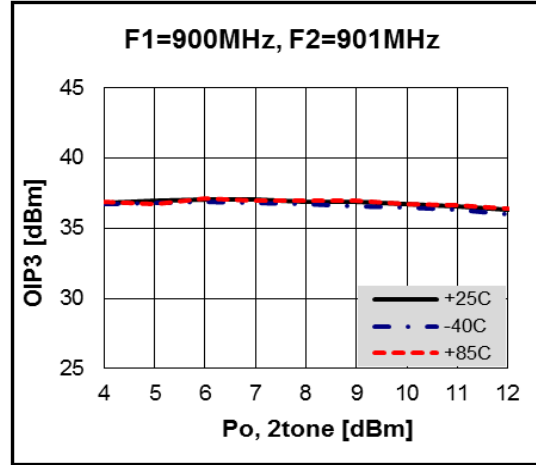
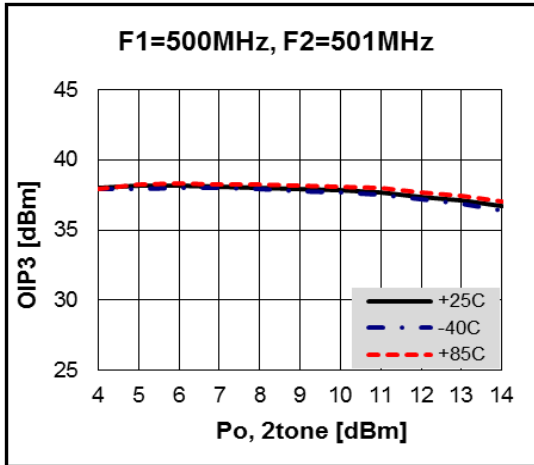
(Vc=5V, Ic=77mA, T=25°C)

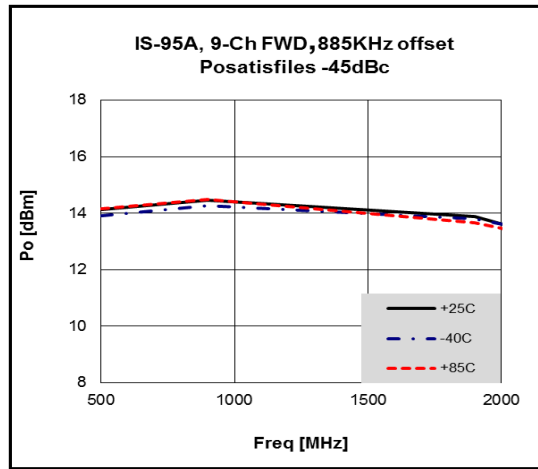
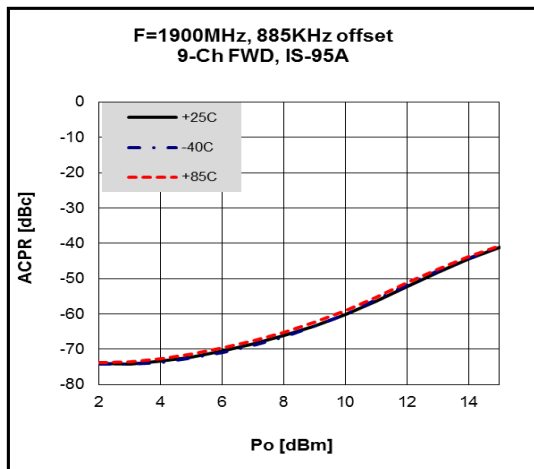
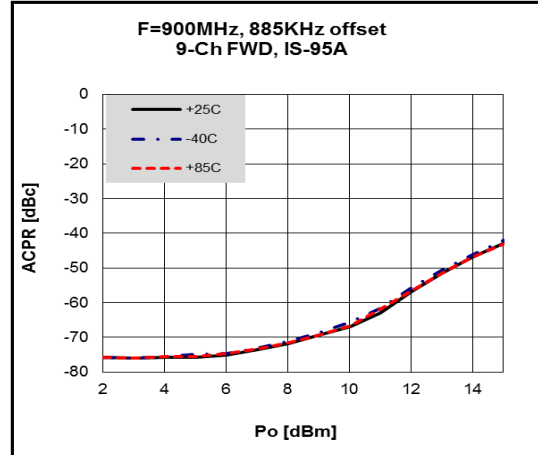
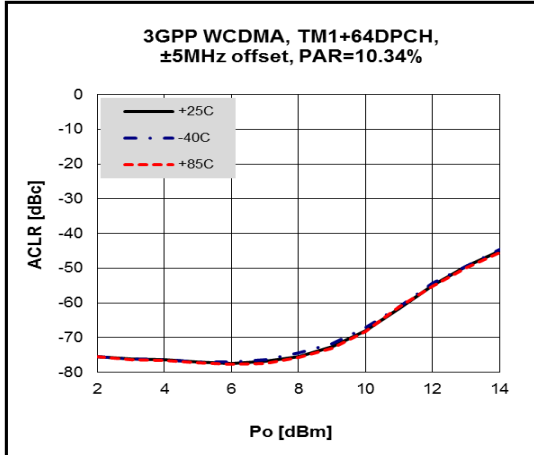
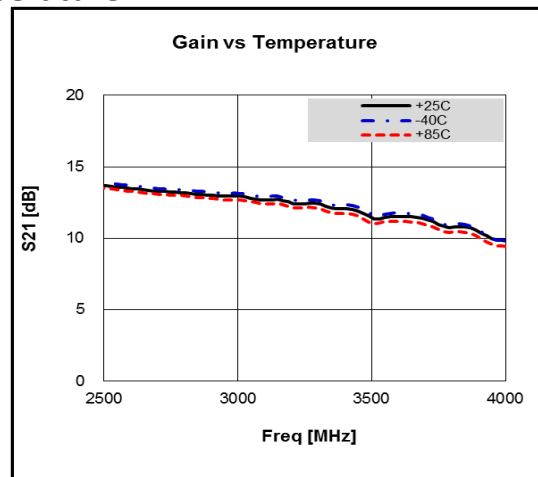
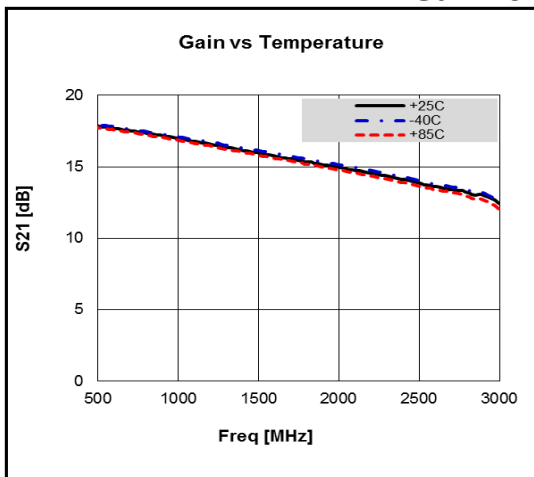
Pin-Pout-Gain

900MHz

1900 MHz

OIP3

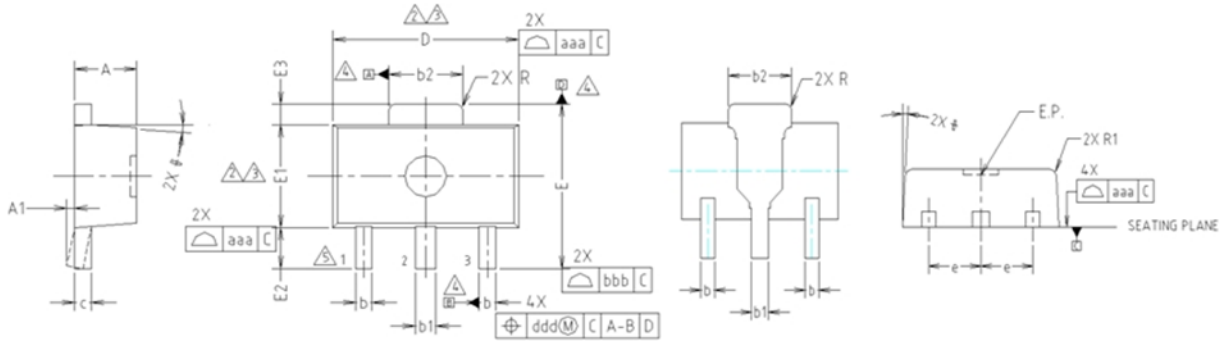
ACPR

Gain vs Temperature

Package Outline Dimension



- NOTE:**
 1. DIMENSIONS IN MILLIMETERS.
- ⚠ DIMENSION D DOES NOT INCLUDE MOLD FLASH, PROTRUSIONS OR GATE BURRS. MOLD FLASH, PROTRUSIONS OR GATE BURRS SHALL NOT EXCEED 0.5mm PER END. DIMENSION E1 DOES NOT INCLUDE INTERLEAD FLASH OR PROTRUSION. INTERLEAD FLASH OR PROTRUSION SHALL NOT EXCEED 0.5mm PER SIDE.
 - ⚠ DIMENSIONS D AND E1 ARE DETERMINED AT THE OUTMOST EXTREMES OF THE PLASTIC BODY EXCLUSIVE OF MOLD FLASH, TIE BAR BURRS, GATE BURRS AND INTERLEAD FLASH, BUT INCLUDING ANY MISMATCH BETWEEN THE TOP AND BOTTOM OF THE PLASTIC BODY.
 - ⚠ DATUMS A, B AND D TO BE DETERMINED 0.18mm FROM THE LEAD TIP.
 - ⚠ TERMINAL NUMBERS ARE SHOWN FOR REFERENCE ONLY.

SYMBOL	MILLIMETERS			NOTE
	MINIMUM	NOMINAL	MAXIMUM	
A	1.40	1.50	1.60	
A1	0.00	—	0.10	
b	0.38	0.42	0.48	
b1	0.48	0.52	0.58	
b2	1.79	1.82	1.87	
c	0.40	0.42	0.46	
D	4.40	4.50	4.70	2,3
E	3.70	4.00	4.30	
E1	2.40	2.50	2.70	2,3
E2	0.80	1.00	1.20	
E3	0.40	0.50	0.60	
e	1.50 TYP.			
φ	4° TYP.			
R	0.15 TYP.			
R1	—	—	0.20	
SYMBOL	TOLERANCES OF FORM AND POSITION		NOTE	
aaa	0.15			
bbb	0.20			
ccc	0.10			
ddd	0.10			

Suggested PCB Land Pattern and PAD Layout

PCB Land Pattern

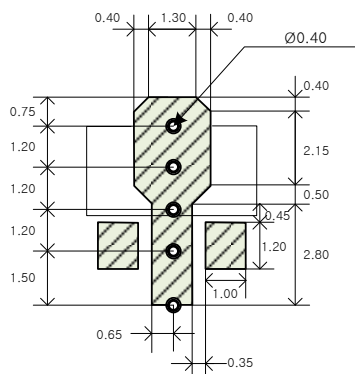

Note : All dimension _ millimeters

PCB lay out _ on BeRex website

PCB Mounting

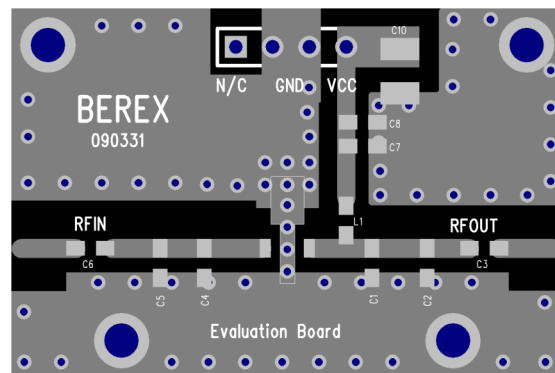

Package Marking

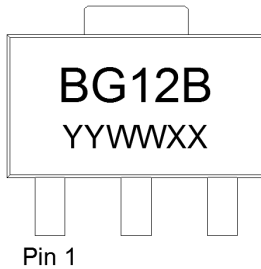

YY = Year, WW = Working Week,
XX = Wafer No.

Tape & Reel

SOT89

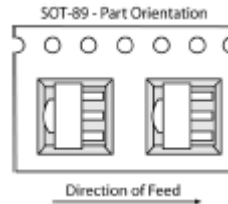

Packaging information:

Tape Width (mm): 12
Reel Size (inches): 7
Device Cavity Pitch (mm): 8
Devices Per Reel: 1000

Lead plating finish

100% Tin Matte finish

(All BeRex products undergoes a 1 hour, 150 degree C, Anneal bake to eliminate thin whisker growth concerns.)

MSL / ESD Rating

ESD Rating:	Class 1C
Value:	Passes <2000V
Test:	Human Body Model (HBM)
Standard:	JEDEC Standard JESD22-A114
MSL Rating:	Level 1 at +260°C convection reflow
Standard:	JEDEC Standard J-STD-020



Proper ESD procedures should be followed when handling this device.

RoHS Compliance

This part is compliant with Restrictions on the Use of Certain Hazardous Substances in Electrical and Electronic Equipment (RoHS) Directive 2011/65/EU as amended by Directive 2015/863/EU.



This product also is compliant with a concentration of the Substances of Very High Concern (SVHC) candidate list which are contained in a quantity of less than 0.1%(w/w) in each components of a product and/or its packaging placed on the European Community market by the BeRex and Suppliers.

NATO CAGE code:

2	N	9	6	F
---	---	---	---	---

Looking for pricing, stock, or lifecycle information?

Click below to explore more details on WIN SOURCE:

-  [View BG12B on WIN SOURCE](#)
-  [BeRex Corporation Information](#)

Optimize Your Supply Chain with WIN SOURCE Solutions

-  Global Sourcing Solution
-  Obsolete Management
-  Cost Control Management
-  Shortage Management
-  Alternative Solution
-  Excess Inventory Management