

Product Overview

The QPL1840 is a GaAs pHEMT single ended MMIC RF amplifier IC featuring 17dB of gain and low noise from 5MHz to 1800MHz. This high linearity IC is designed to support Broadband CATV DOCSIS 4.0 applications, such as Nodes, Amplifiers, and Remote PHY Devices, as well as Fiber to The Home (FTTH), Home Gateways, and Cable Modems. The device is powered by a single supply that can operate at 5V to 8V with current set from 125 mA to 135 mA. At 5V and 125 mA the QPL1840 provides an output of 54dBmV TCP with a CCN of 51dB. The QPL1840 is packaged in a 3 x 3 16-pin QFN.

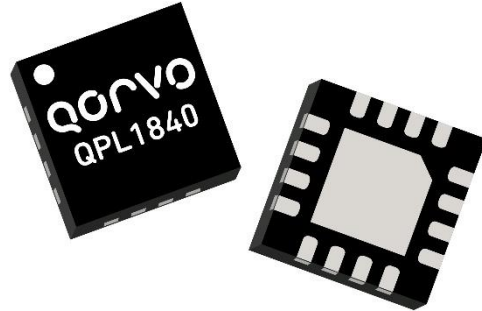

3 x 3 16-pin QFN

Functional Block Diagram

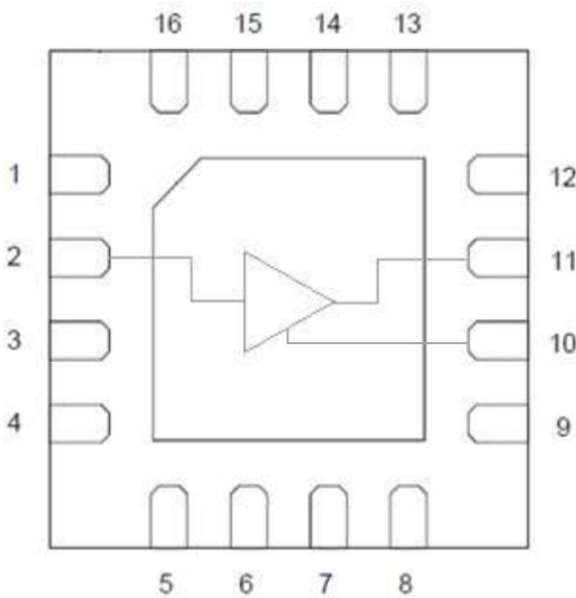

3 x 3 16-pin QFN Package

Key Features

- 5 MHz to 1800 MHz Operation
- 5V & 8V Operation
- Gain: 17.5dB Typical
- TCP: 54dBmV @ 5V
- Noise Figure: 1.5dB @ 1800MHz
- Adjustable Bias Using External Resistors
- RoHS Compliant

Applications

- DOCSIS 4.0 Amplifiers
- DOCSIS 4.0 Optical Nodes
- DOCSIS 4.0 Remote PHY Devices
- FTTH GPON and GEPON
- DOCSIS 4.0 Cable Modem and Home Gateways

Ordering Information

Part Number	Description	Part Number	Description
QPL1840EVB-01	5V Downstream Evaluation Board	QPL1840SB	Sample bag with 5 pieces
QPL1840EVB-02	5V Upstream Evaluation Board	QPL1840SR	7" Reel with 100 pieces
QPL1840EVB-03	8V Downstream Evaluation Board	QPL1840TR7	7" Reel with 2500 pieces
QPL1840EVB-04	8V Upstream Evaluation Board		



Table of Contents

Table of Contents.....	2
Absolute Maximum Ratings	3
Electrical Specifications (Downstream)	3
Evaluation Board Schematic 50 MHz – 1800 MHz (Downstream).....	4
Evaluation Board Assembly Drawing (Downstream).....	4
Evaluation Board Bill of Materials for Downstream 5V	5
BOM Changes for Downstream 8V Operation.....	5
Performance Data, Downstream 5V	6
Performance Data, Downstream 5V (cont'd).....	7
Performance Data, Downstream 8V	8
Performance Data, Downstream 8V (Cont'd)	9
Electrical Specifications (Upstream)	10
Evaluation Board Schematic 5 MHz – 850 MHz (Upstream).....	11
Evaluation Board Assembly Drawing (Upstream)	11
Evaluation Board Bill of Materials for Upstream 5V.....	12
BOM Changes for Upstream 8V Operation	12
Performance Data, Upstream 5V.....	13
Performance Data, Upstream 5V (Cont'd).....	14
Performance Data, Upstream 8V.....	15
Performance Data, Upstream 8V (Cont'd).....	17
Pin Configuration and Description	19
Package Outline.....	20
Package Marking	21
Tape and Reel	21
Handling Precautions.....	22
Solderability	22
RoHS Compliance	22
Contact Information.....	22
Important Notice.....	23

Absolute Maximum Ratings

Parameter	Rating
Supply Voltage (V _{DD})	+10 V
Supply Current (I _{DD})	160 mA
Maximum Input Level	+65 dBmV
Operating Temperature Range (Operating Device Heat Slug Temperature)	-40 to +100 °C
Storage Temperature Range	-65 to +150 °C
Maximum Junction Temperature	+150 °C

Exceeding any one or a combination of the Absolute Maximum Rating conditions may cause permanent damage to the device. Extended application of Absolute Maximum Rating conditions to the device may reduce device reliability.

Electrical Specifications (Downstream)

Parameter	Test Condition	Min	Typ	Max	Unit
Supply Voltage (V _{DD})			5/8		V
Supply Current (I _{DD})			125/135		mA
Frequency Range		50		1800	MHz
Gain			17.5		dB
Reverse Isolation			21		dB
Input Return Loss	50 – 1800MHz		-20		dB
Output Return Loss	50 – 1800MHz		-20		dB
CCN	+54dBmV @ 5V Total Composite Output power		51		
	258MHz to 1791MHz, 256 Ch, SC-QAM, 0dB tilt, 6dB Offset at 1023MHz				dB
Noise Figure	50 - 1800MHz		1.5		dB
OIP2L	+5 dBm / tone output, Δf=53MHz, Full Band		70/69		dBm
OIP2U	+5 dBm / tone output, Δf=53MHz, Full Band		55/55		dBm
OIP3	+5 dBm / tone output, Δf=6MHz, Full Band		33/32		dBm
OP1dB	50-1800MHz		20/23		dBm
Thermal Resistance	ΘJC (Junction to Device Heat Slug)		27.5		°C/W

Note: Typical performance at these conditions: Temp = +25 °C, V_{DD} = +5 V, 75 Ω system, Full band unless otherwise noted

Evaluation Board Schematic 50 MHz – 1800 MHz (Downstream)

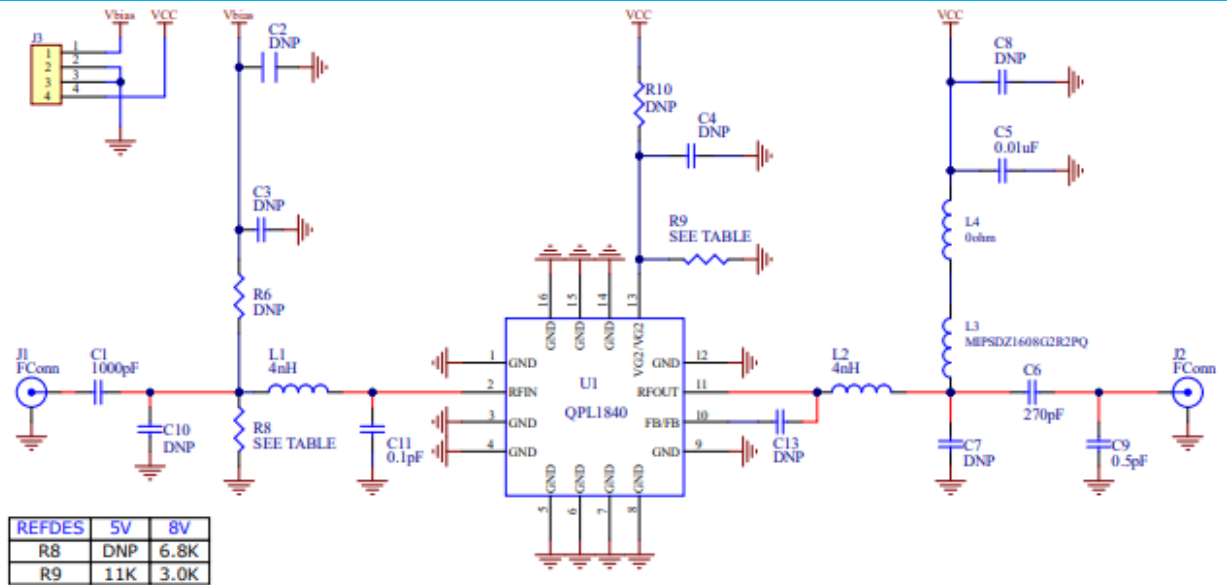

Evaluation Board Assembly Drawing (Downstream)

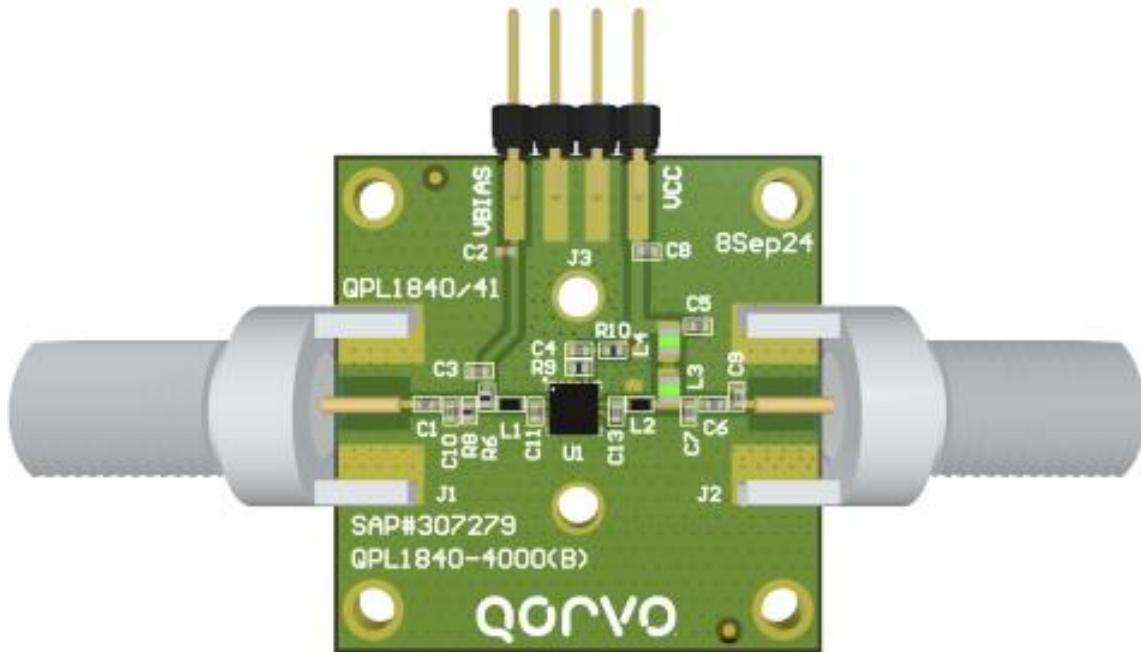

LAYER STACK LEGEND

Material	Layer	Thickness	Dielectric	Material	Type
	Top Overlay				Legend
Surface Material	Top Solder	0.0010in	SM-001		Solder Mask
Metal	Top Layer	0.0014in	10z		Signal
Core		0.0580in	FR408HR		Dielectric
Metal	Bottom Layer	0.0014in	10z		Signal
Total thickness: 0.0618					



Evaluation Board Bill of Materials for Downstream 5V

Ref Des	Description	Manufacturer	Part Number
PCB	PCB, QPL1840	Qorvo	QPL1840-4000(B)
U1	1.8GHz 5V, 17dB gain	Qorvo	QPL1840
C1	CAP, 1000pF, 5%, 50V, C0G, 0402	MURATA	GRM1555C1H102JA01D
C5	CAP, 0.01uF, 10%, 50V, X7R, 0402	MURATA	GCM155R71H103KA55D
C6	CAP, 270pF, 5%, 50V, C0G, 0402	MURATA	GCM1555C1H271JA16D
C9	CAP, 0.5pF, +/-0.25pF, 50V, HI-Q, 0402	MURATA	GJM1555C1HR50CB01D
C11	CAP, 0.1pF, +/-0.05pF, 50V, HI-Q, 0402	MURATA	GJM1555C1HR10WB01D
R9	RES, 11K OHM, 5%, 1/10W, 0402	Kamaya, Inc	RMC1/16S-113JTH
L4	RES, 0 OHM, JMPR, 1/3W, 0603	VISHAY AMERICAS	CRCW06030000Z0EAHP
L1, L2	IND, 4nH, ±0.1nH, W/W, HI-Q, 1950mA, 0402	MURATA	LQW15AN4N0B80D
L3	IND, 2.2uH, 20%, 0.36A, 0.7mm, W/W, 0603	TAIYO YUDEN	BRL1608T2R2M
J1, J2	CONN, F FEM EDGE MOUNT, 75R, 0.068"	Millimeter Wave	MW-846-C-DD-75
J3	CONN, HDR, ST, 4-PIN, 0.100"	SAMTEC INC.	TSW-104-08-S-S
C2,C3,C4,C7,C8, C10,C13,R6,R8,R10	NOT POPULATED ITEM		DUMMY PART

BOM Changes for Downstream 8V Operation

R8	6.8K OHM, 5%, 1/16W, 0402	KOA Speer Electronics, Inc	RK73B1ETTP682J
R9	RES, 3K OHM, 5%, 1/10W, 0402	Kamaya, Inc	RMC1/16S-302JTH

Performance Data, Downstream 5V

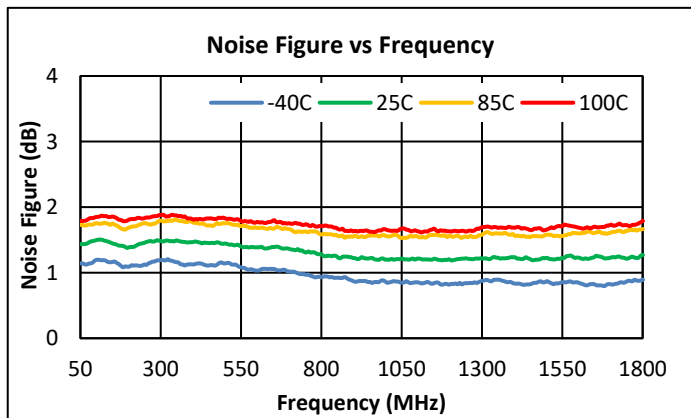
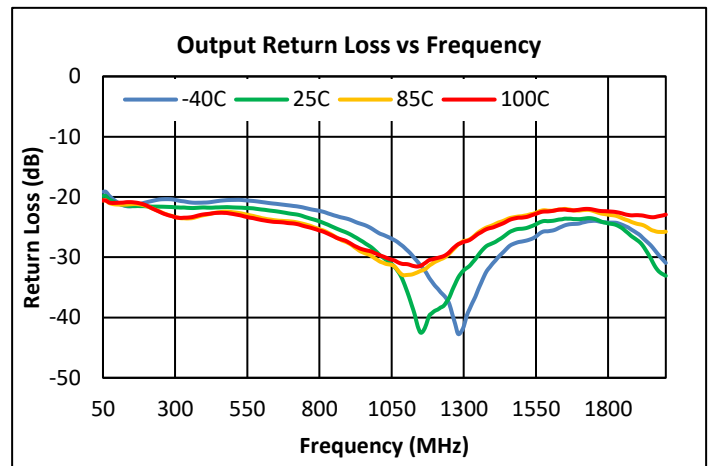
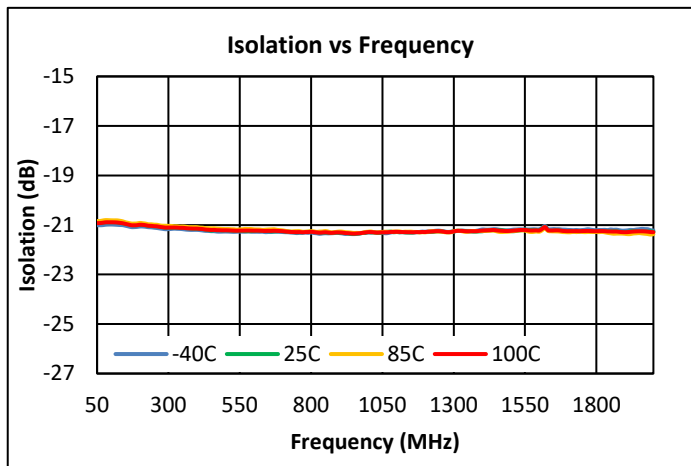
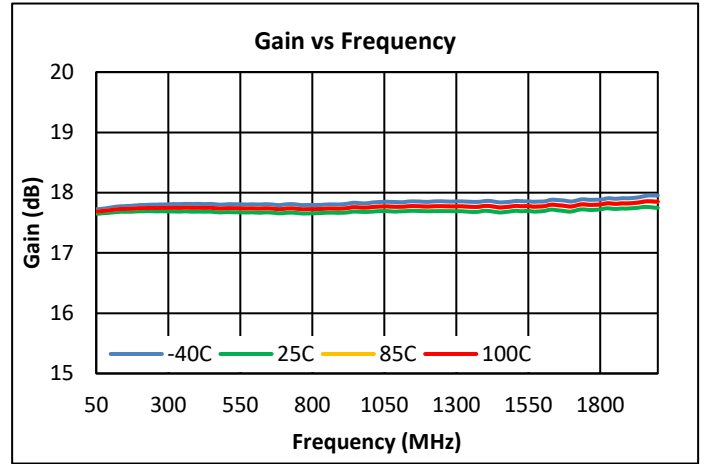
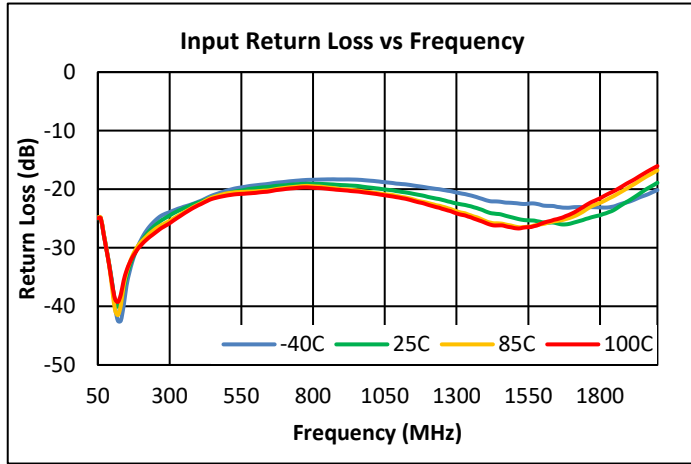

Performance Data, Downstream 5V (cont'd)

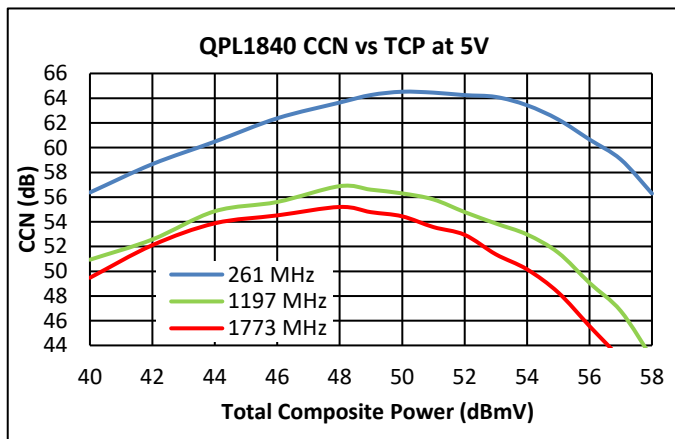
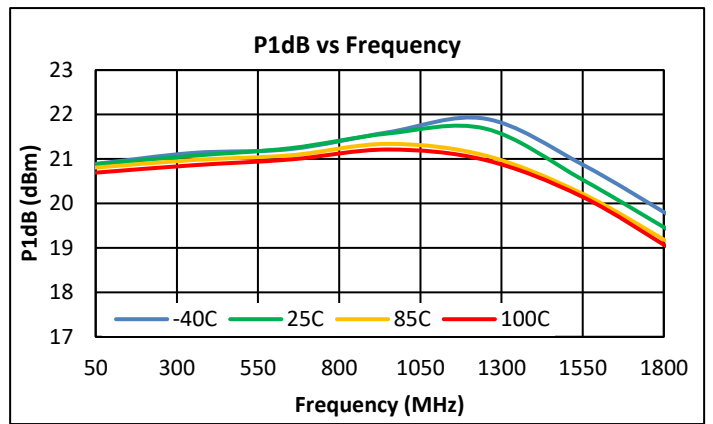
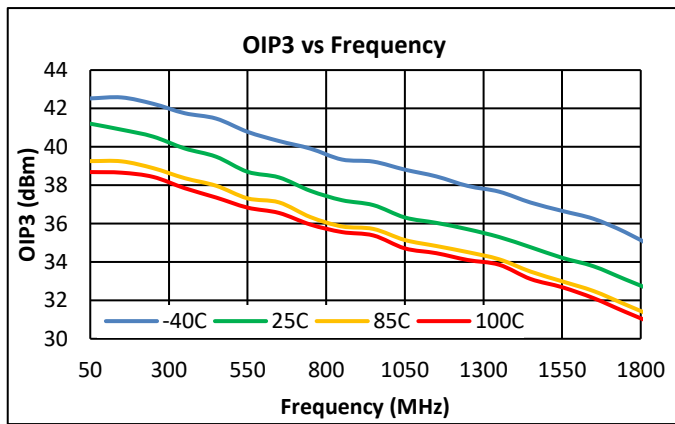
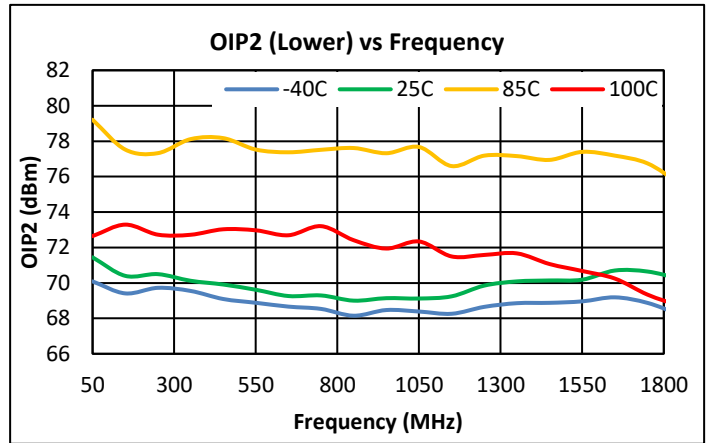
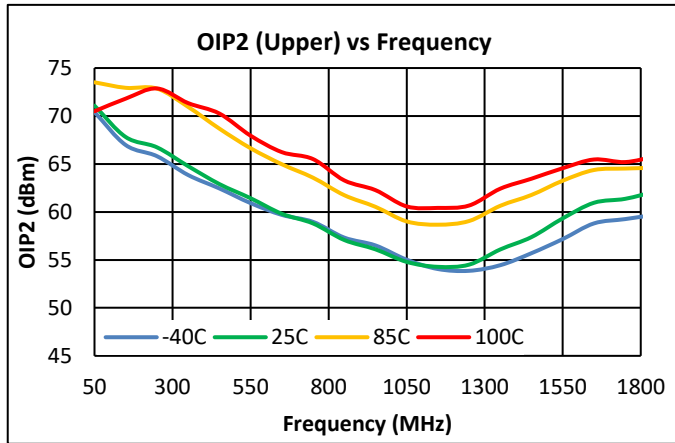

Notes:

- (1) 5V OIP2: +5Bm /tone output @ Δf = 53MHz
- (2) 5V OIP3: +5dBm /tone output @ Δf = 6MHz
- (3) CCN Test conditions: 0dB tilt, 6dB offset at 1023MHz, 258-1791MHz loading
- (4) BER Test Conditions: 258 – 1791 MHz, 256 Ch SC-QAM, 0dB tilt, 6dB offset

Performance Data, Downstream 8V

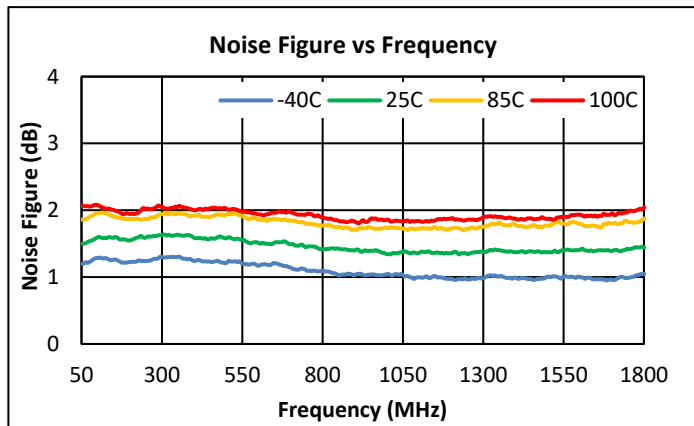
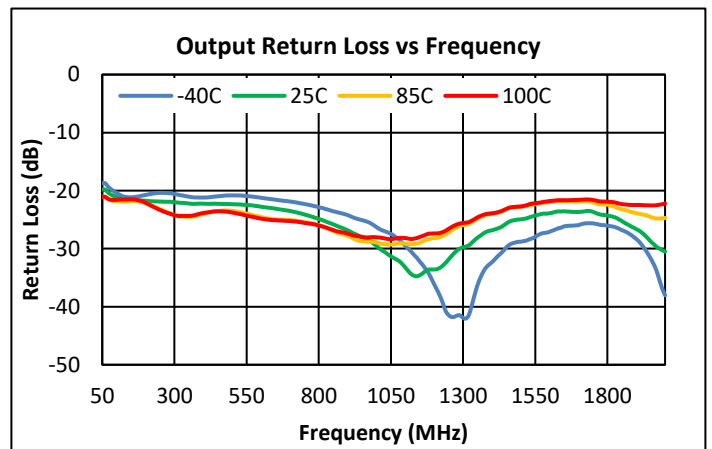
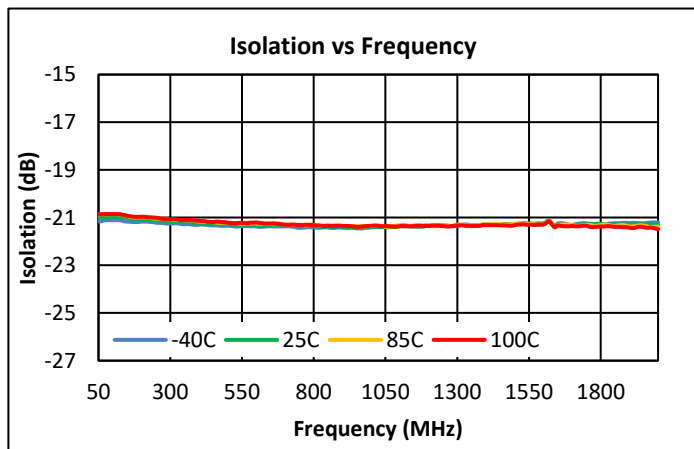
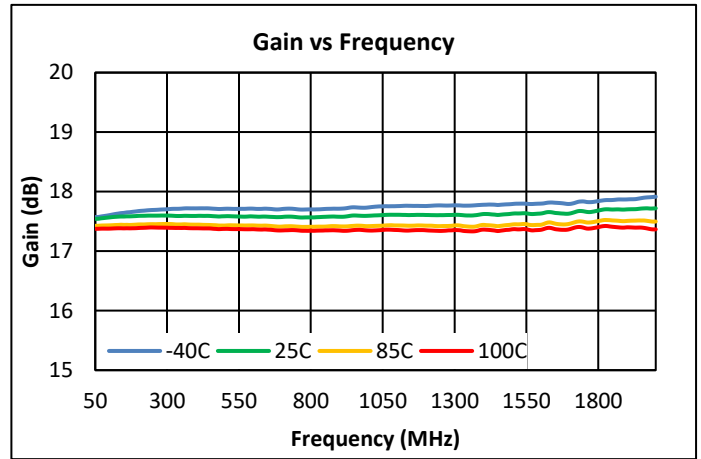
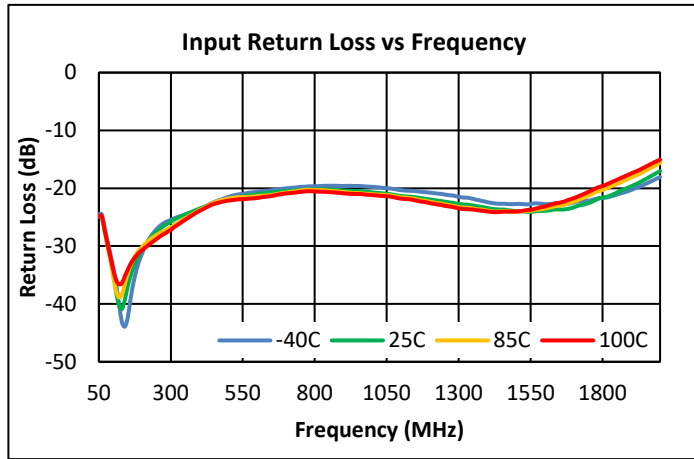

Performance Data, Downstream 8V (Cont'd)

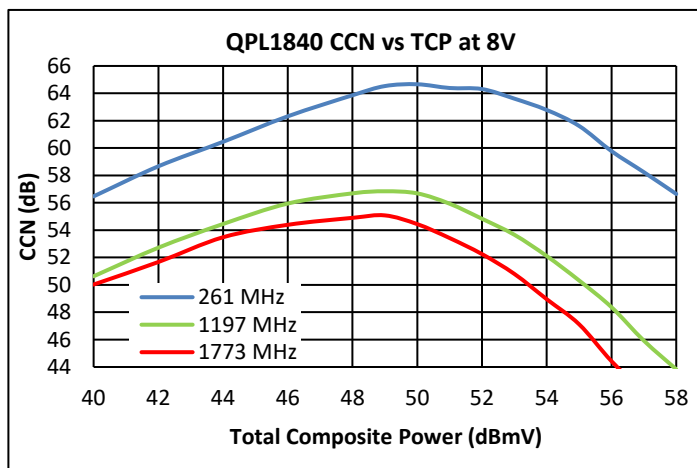
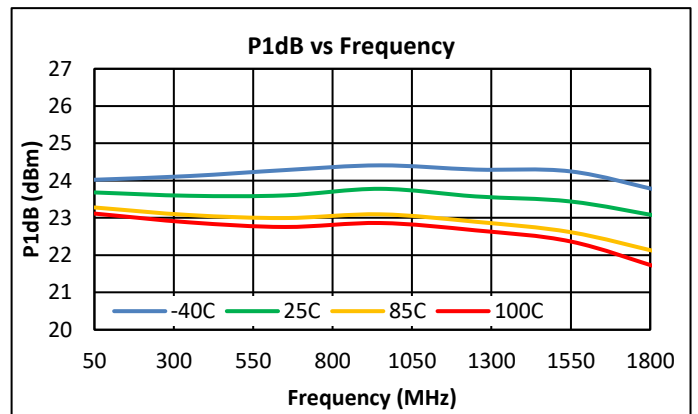
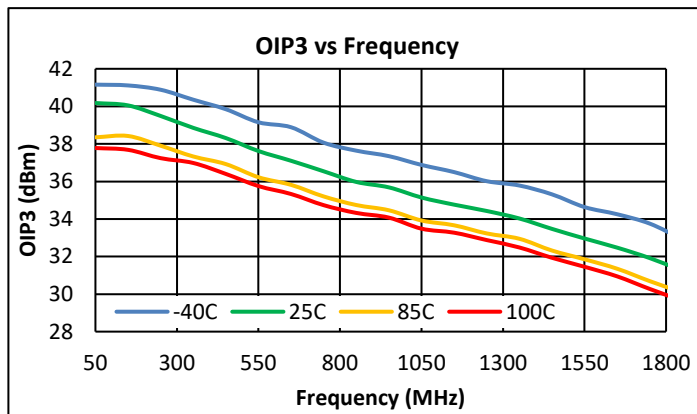
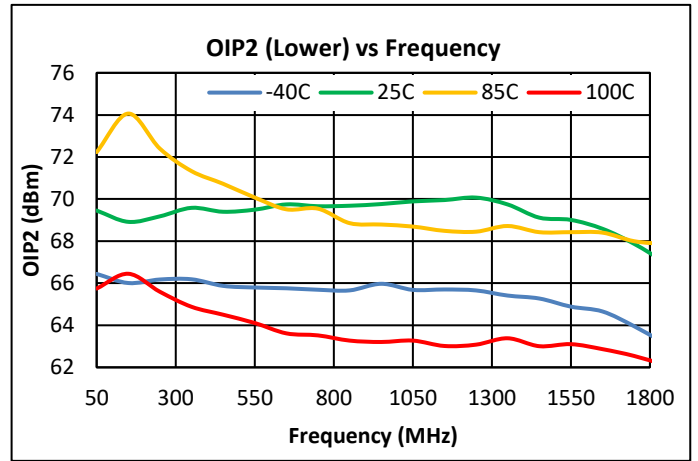
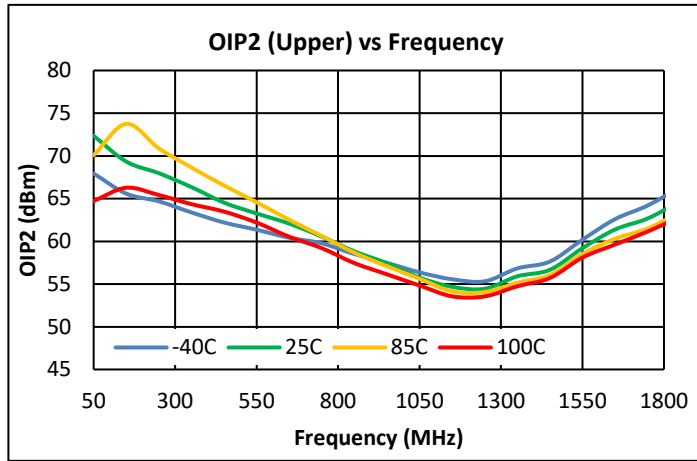

Notes:

- (1) 8V OIP2: +5dBm/tone output @ $\Delta f = 53\text{MHz}$
- (2) 8V OIP3: +5dBm /tone output @ $\Delta f = 6\text{MHz}$
- (3) CCN Test conditions: 0dB tilt, 6dB offset at 1023MHz, 258-1791MHz loading
- (4) BER Test Conditions: 258 – 1791 MHz, 256 Ch SC-QAM, 0dB tilt, 6dB offset

**Electrical Specifications (Upstream)**

Parameter	Test Condition	Min	Typ	Max	Unit
Supply Voltage (VDD)			5/8		V
Supply Current (IDD)			115/115		mA
Frequency Range		5		850	MHz
Gain			17.5		dB
Reverse Isolation			21		dB
Input Return Loss	5 – 700MHz		-20		dB
Input Return Loss	700 – 850MHz		-19		
Output Return Loss	5 – 850MHz		-20		dB
MER	At +53dBmV @ 5V and +55dBmV @ 8V Total Composite Output power. 5MHz to 850MHz, 113 Ch, SC-QAM, 0dB tilt, 0dB Offset (Source corrected)		51		dB
Noise Figure	5 - 15MHz		2.0/2.3		dB
Noise Figure	15 - 850		1.6/1.7		dB
OIP2L	+5 dBm / tone output, $\Delta f=53$ MHz, Full Band		65/62		dBm
OIP2U	+5 dBm / tone output, $\Delta f=53$ MHz, Full Band		51/50		dBm
OIP3	+5 dBm / tone output, $\Delta f=6$ MHz, Full Band		34.5/34		dBm
OP1dB	5-850MHz		20/22		dBm
Thermal Resistance	Θ_{JC} (Junction to Device Heat Slug)		27.5		$^{\circ}\text{C}/\text{W}$

Note: Typical performance at these conditions: Temp = +25 $^{\circ}\text{C}$, V_{DD} = +5 V, 75 Ω system, Full band unless otherwise noted

Evaluation Board Schematic 5 MHz – 850 MHz (Upstream)

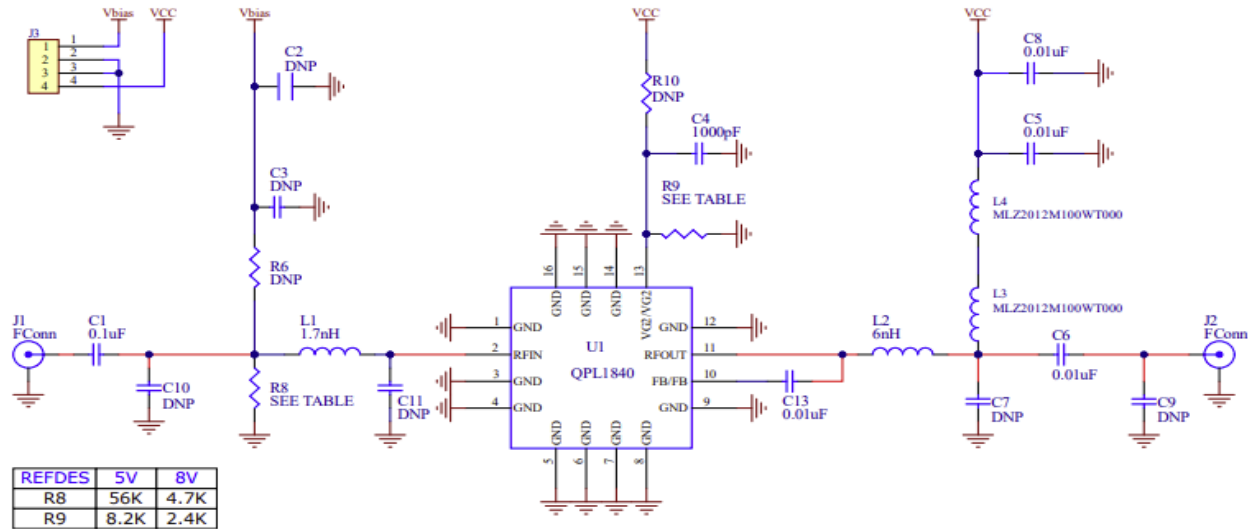

Evaluation Board Assembly Drawing (Upstream)



LAYER STACK LEGEND

Material	Layer	Thickness	Dielectric Material	Type
	Top Overlay			Legend
Surface Material	Top Solder	0.0010in	SM-001	Solder Mask
Metal	Top Layer	0.0014in	10z	Signal
Core		0.0580in	FR408HR	Dielectric
Metal	Bottom Layer	0.0014in	10z	Signal
Total thickness: 0.0618				



Evaluation Board Bill of Materials for Upstream 5V

PCB	PCB, QPL1840	Qorvo	QPL1840-4000(B)
U1	1.8GHz 5V, 17dB gain	Qorvo	QPL1840
C1	CAP, 0.1uF, 10%, 50V, X5R, 0402	MURATA	04025D104KAT2A
C4	CAP, 1000pF, 10%, 50V, X7R, AEC200 0402	TDK	CGA2B2X7R1H102K050BA
C5,C6,C8,C13	CAP, 0.01uF, 10%, 50V, X7R, 0402	MURATA	GCM155R71H103KA55D
R8	RES, 56K OHM, 5%, 1/10W, 0402	Panasonic	ERJ-2GEJ563X
R9	RES, 8.2K OHM, 5%, 1/10W, 0402	Kamaya, Inc	RMC1/16S-822JTH
L1	IND, 1.7nH, ±0.2nH, W/W,HIQ,1150mA,0402	MURATA	LQW15AN1N7C80D
L2	IND, 6nH, ±0.1nH, W/W, HI-Q, 1600mA,0402	MURATA	LQW15AN6N0B80D
L3,L4	IND, 10uH, 20%, 350mA, M/L, 0805	TDK	MLZ2012M100WT000
J1,J2	CONN, F FEM EDGE MOUNT, 75R, 0.068"	Millimeter Wave	MW-846-C-DD-75
J3	CONN, HDR, ST, 4-PIN, 0.100"	SAMTEC INC.	TSW-104-08-S-S
C2,C3,C7,C9 C10,C11,R6,R10	NOT POPULATED ITEM		DUMMY PART

BOM Changes for Upstream 8V Operation

R8	RES, 4.7K OHM, 5%, 1/10W, 0402	Kamaya, Inc	RMC1/16S-472JTH
R9	RES, 2.4K OHM, 5%, 1/10W, 0402	Kamaya, Inc	RMC1/16S-242JTH

Performance Data, Upstream 5V

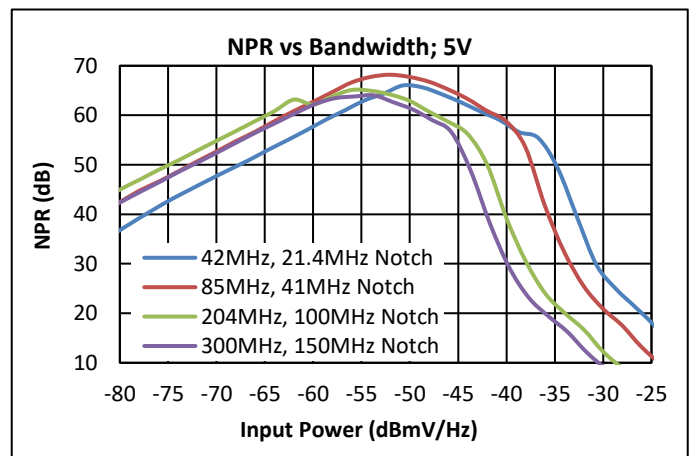
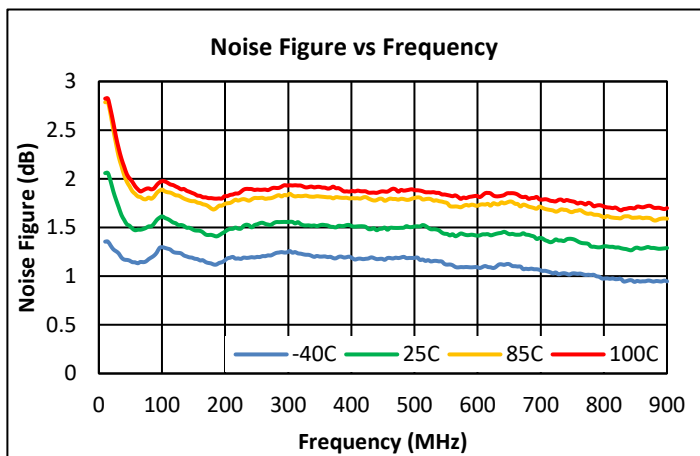
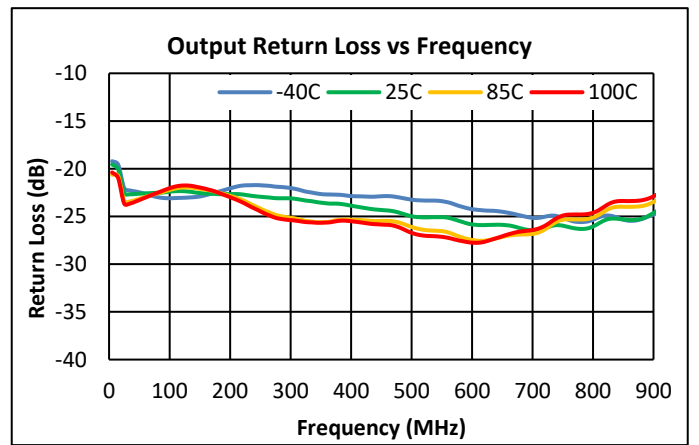
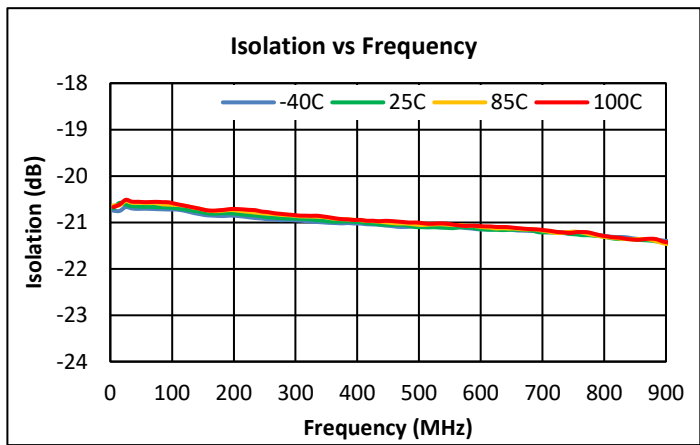
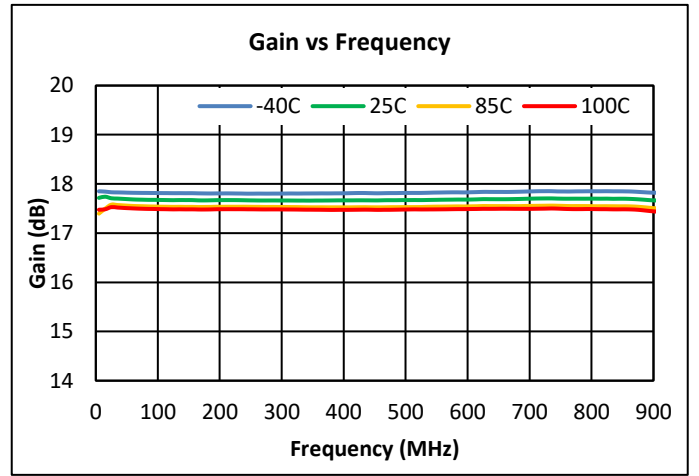
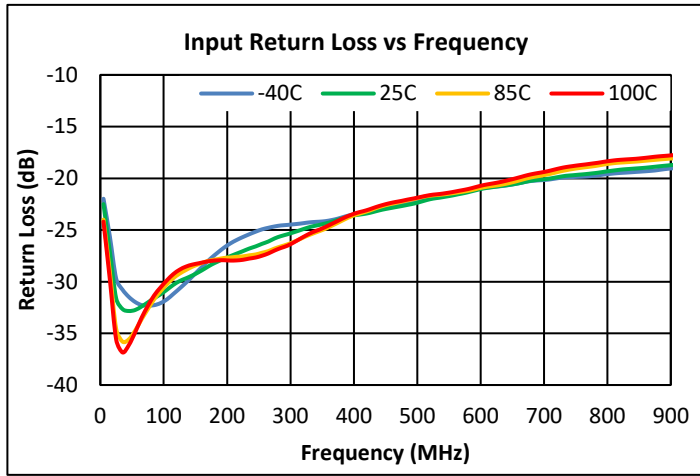

Performance Data, Upstream 5V (Cont'd)

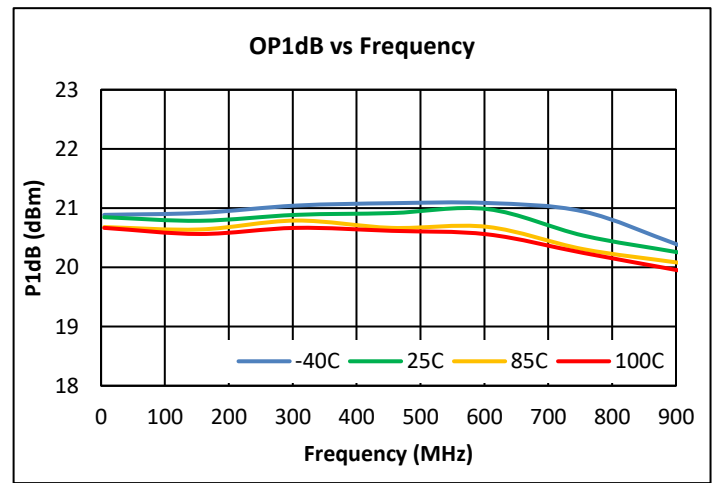
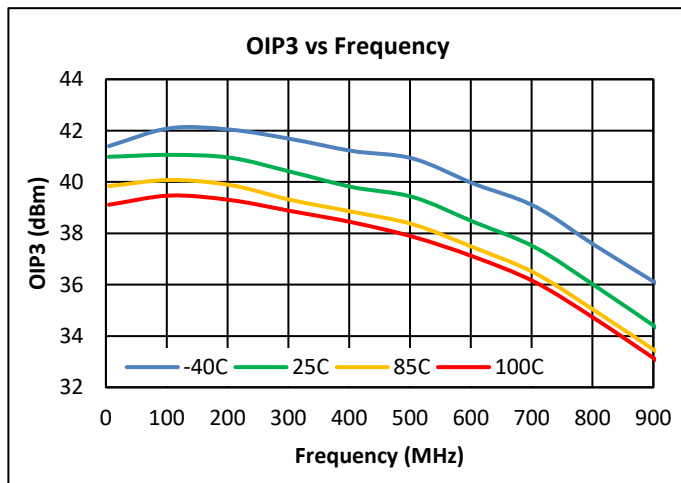
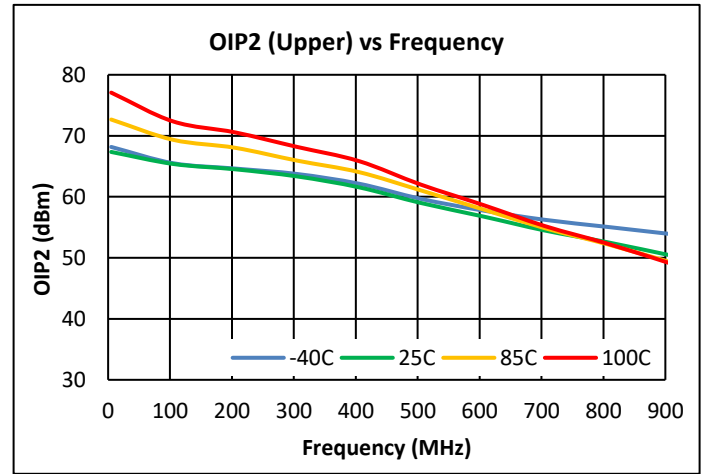
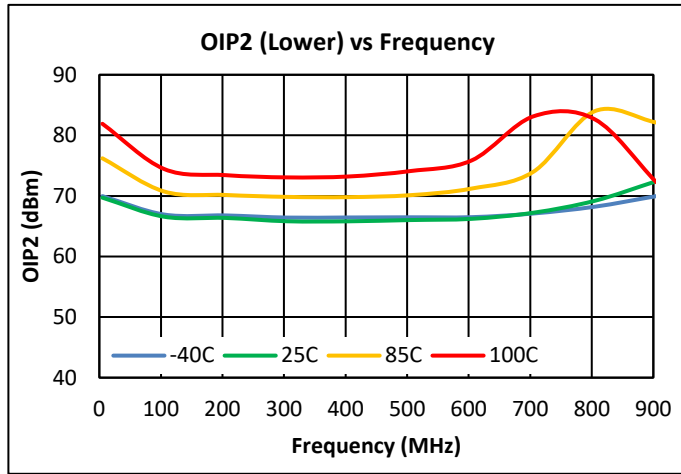

Notes:

- (1) 5V OIP2: +5dBm/ tone output @ $\Delta f = 6\text{MHz}$
- (2) 5V OIP3: +5dBm/ tone output @ $\Delta f = 6\text{MHz}$

Performance Data, Upstream 5V

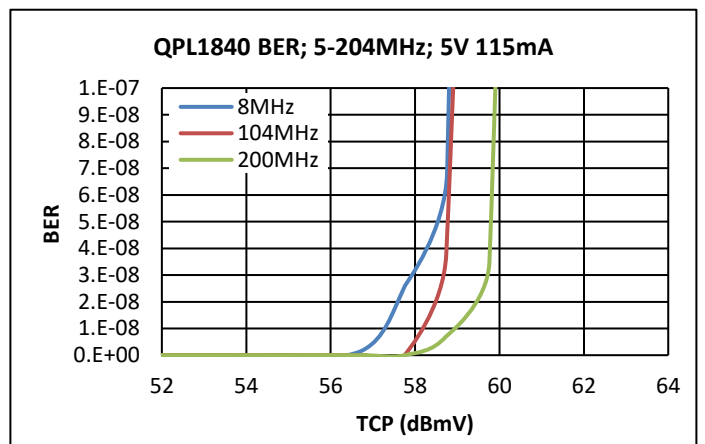
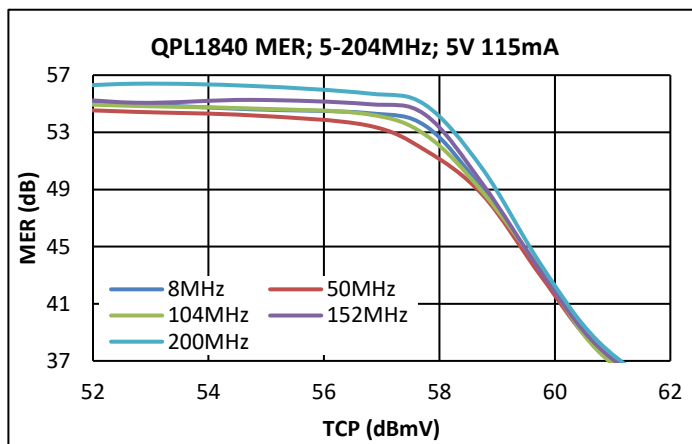
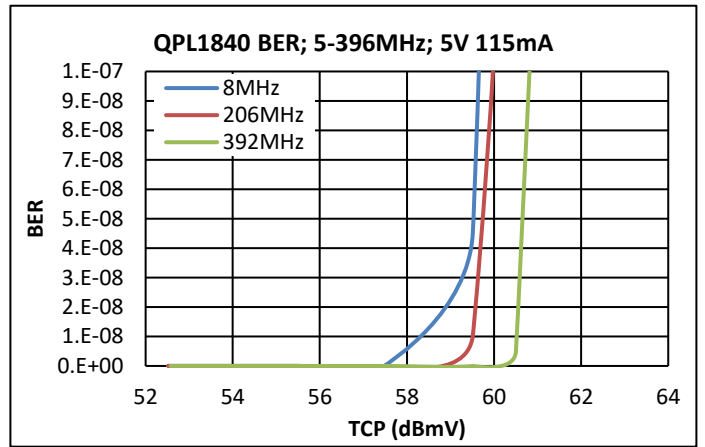
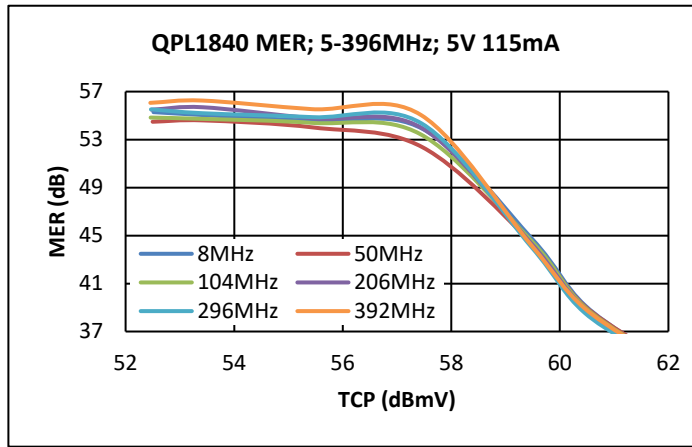
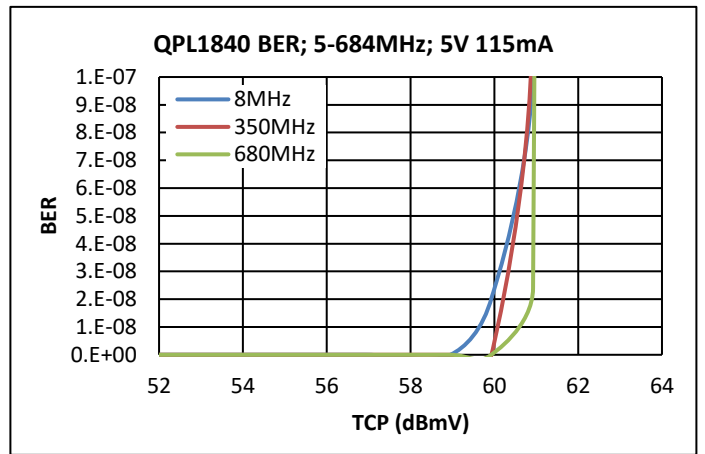
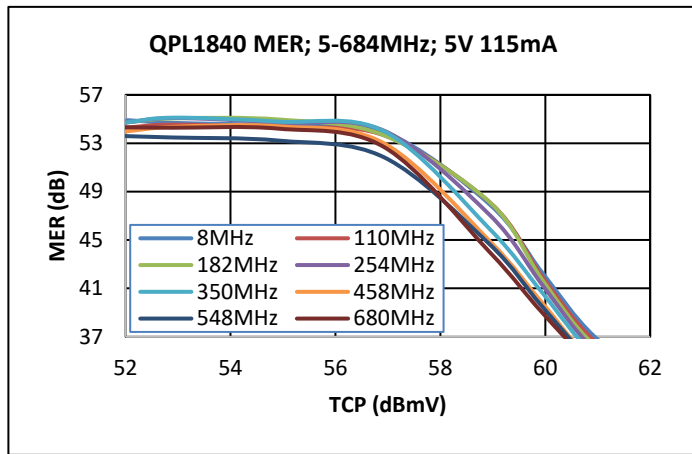

Notes:

- (1.) BER & MER Test Conditions: 5-684MHz, 113 Ch SC-QAM, 0dB Tilt
- (2.) BER & MER Test Conditions: 5-396MHz, 65 Ch SC-QAM, 0dB Tilt
- (3.) BER & MER Test Conditions: 5-204MHz, 33 Ch SC-QAM, 0dB Tilt
- (4.) Source corrected

Performance Data, Upstream 8V

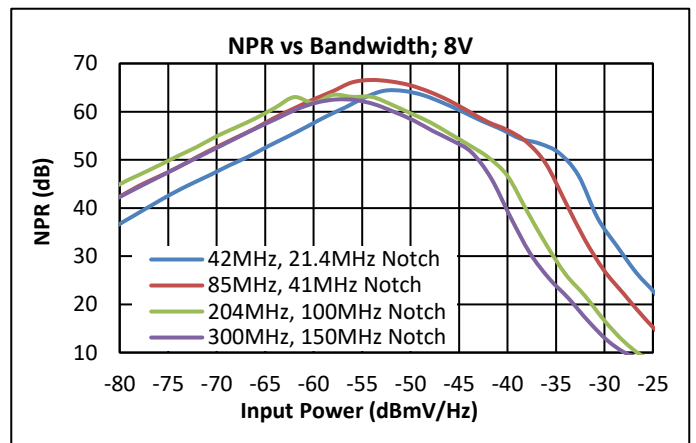
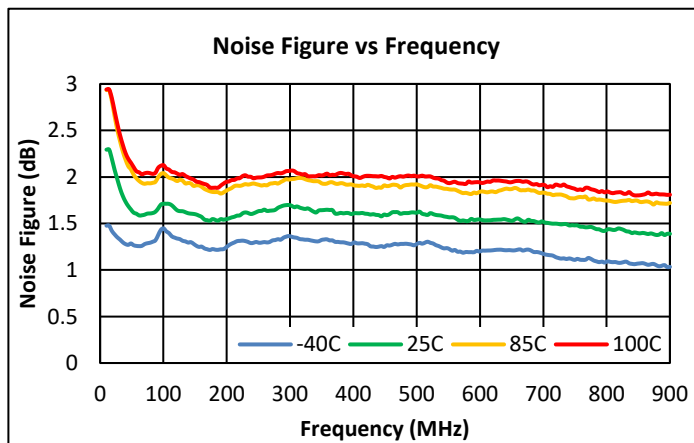
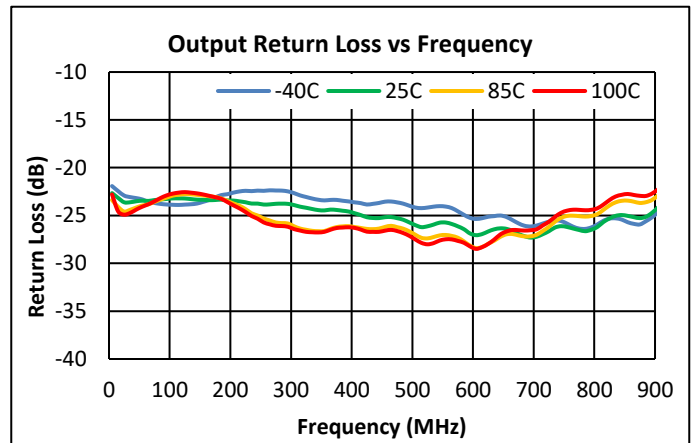
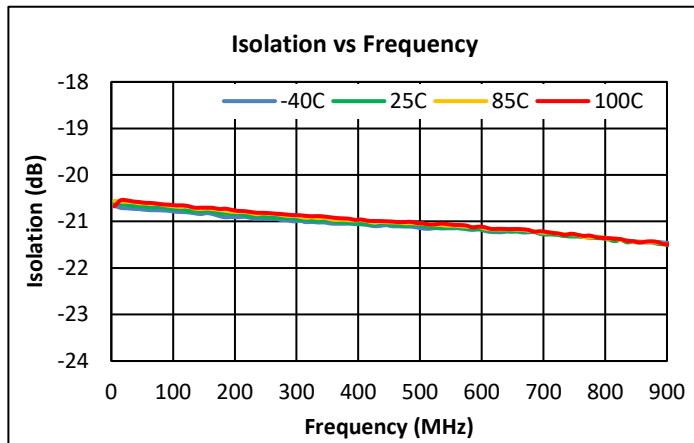
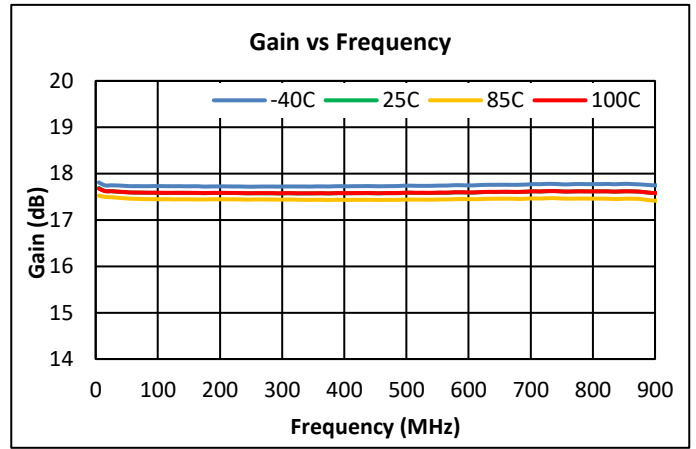
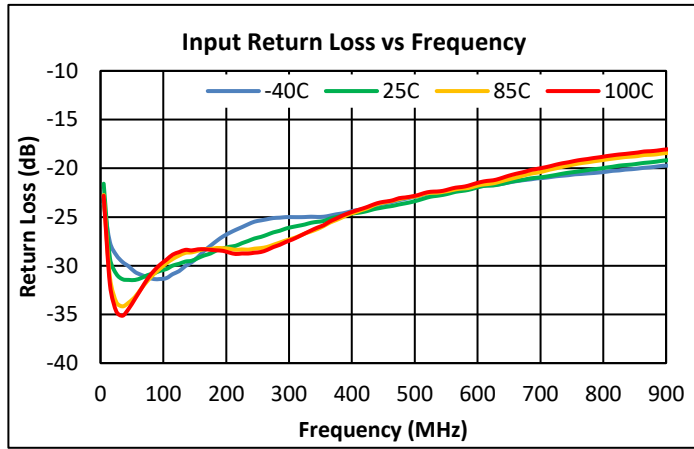

Performance Data, Upstream 8V (Cont'd)

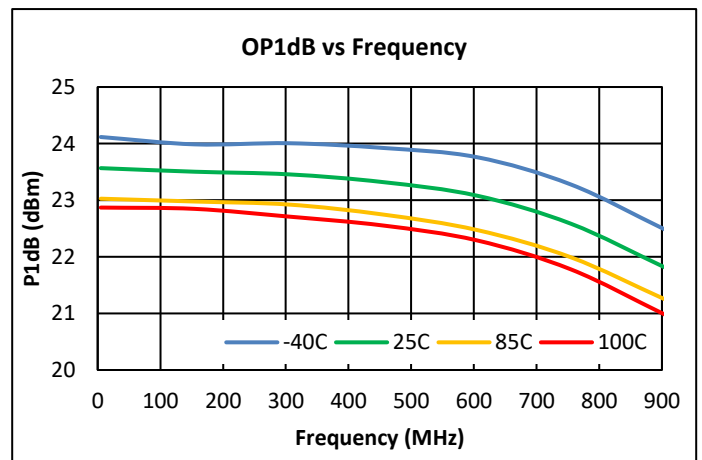
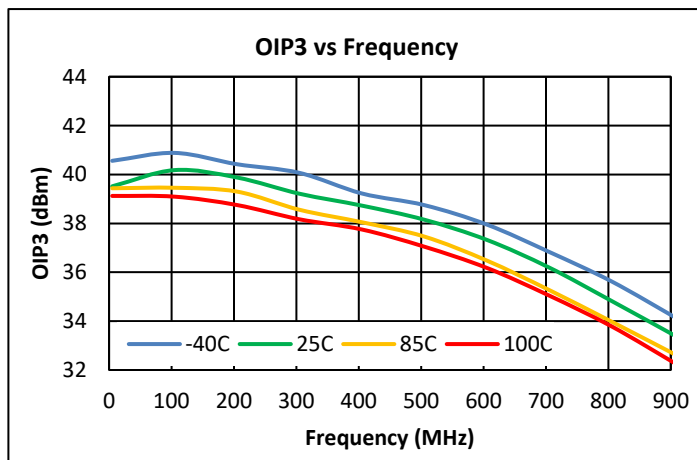
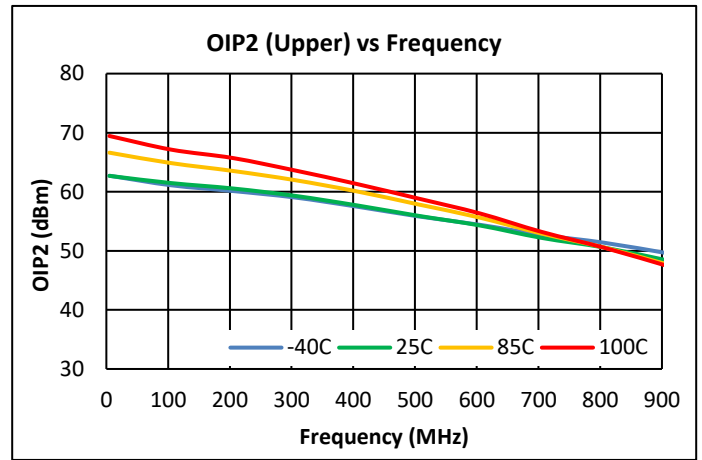
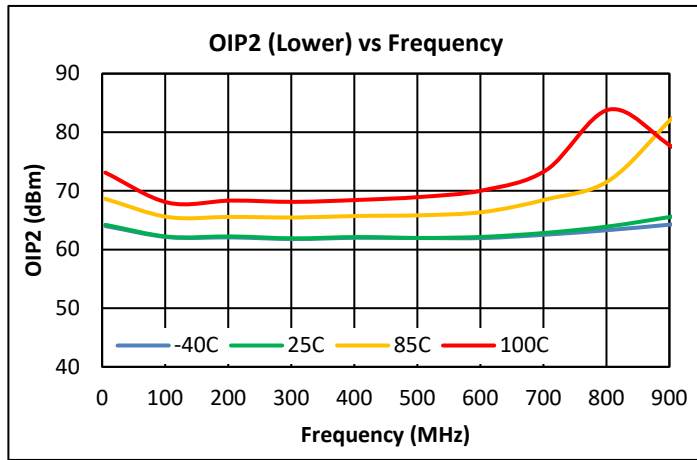

Notes:

- (1) 8V OIP2: +5dBm/tone output @ $\Delta f = 6\text{MHz}$
- (2) 8V OIP3: +5dBm/tone output @ $\Delta f = 6\text{MHz}$

Performance Data, Upstream 8V

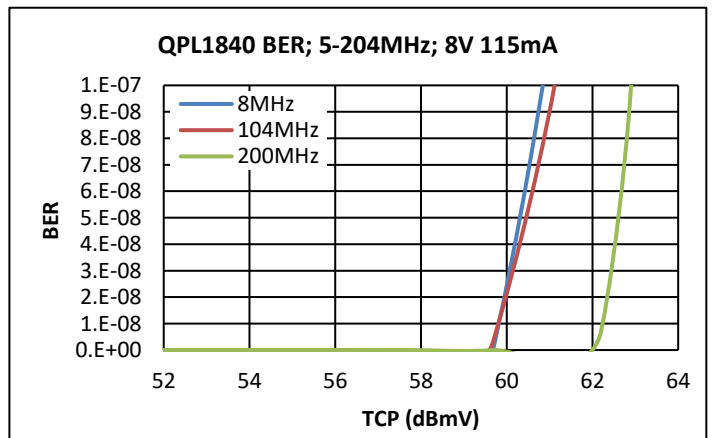
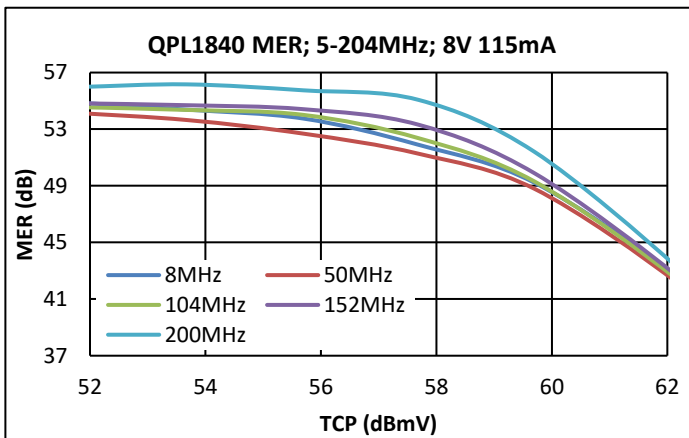
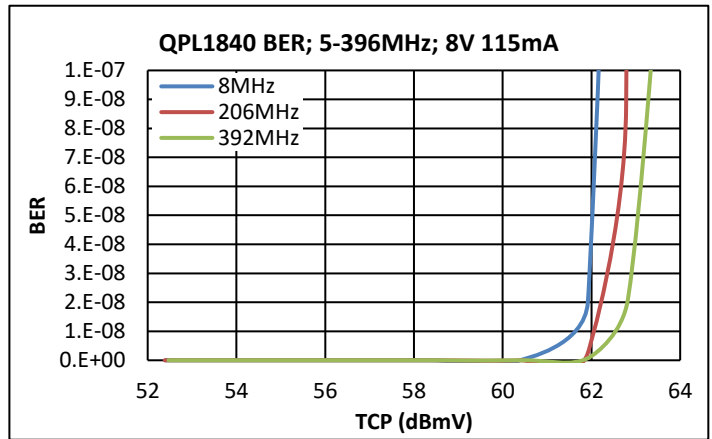
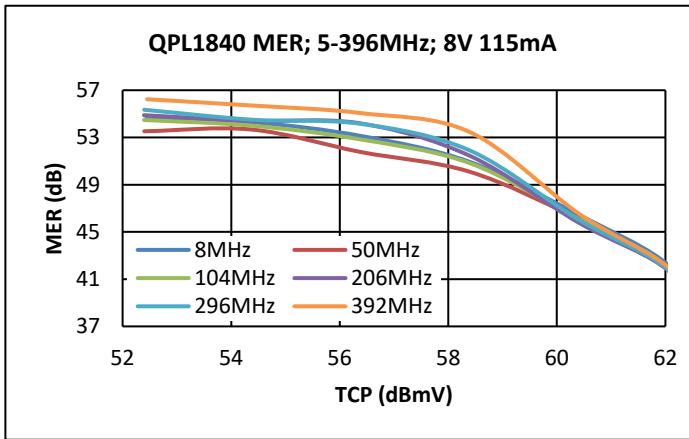
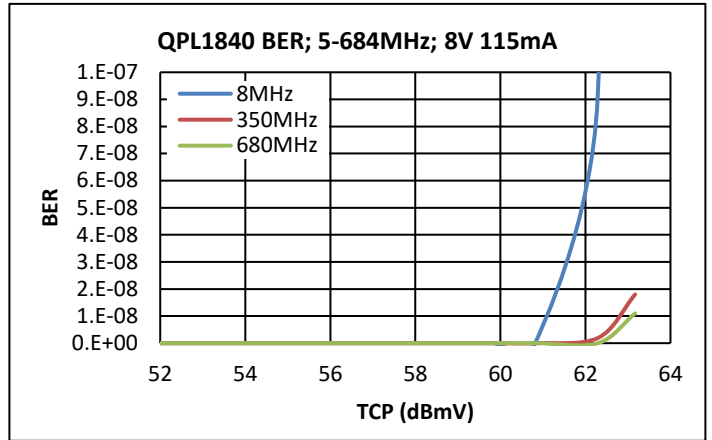
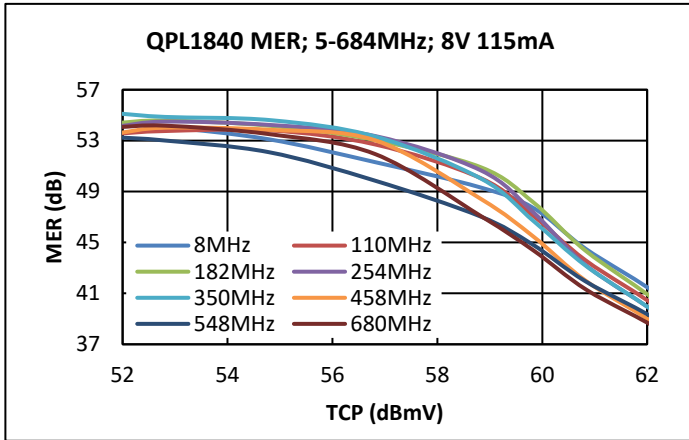

Notes:

- (1.) BER & MER Test Conditions: 5-684MHz, 113 Ch SC-QAM, 0dB Tilt
- (2.) BER & MER Test Conditions: 5-396MHz, 65 Ch SC-QAM, 0dB Tilt
- (3.) BER & MER Test Conditions: 5-204MHz, 33 Ch SC-QAM, 0dB Tilt
- (4.) Source corrected

Pin Configuration and Description

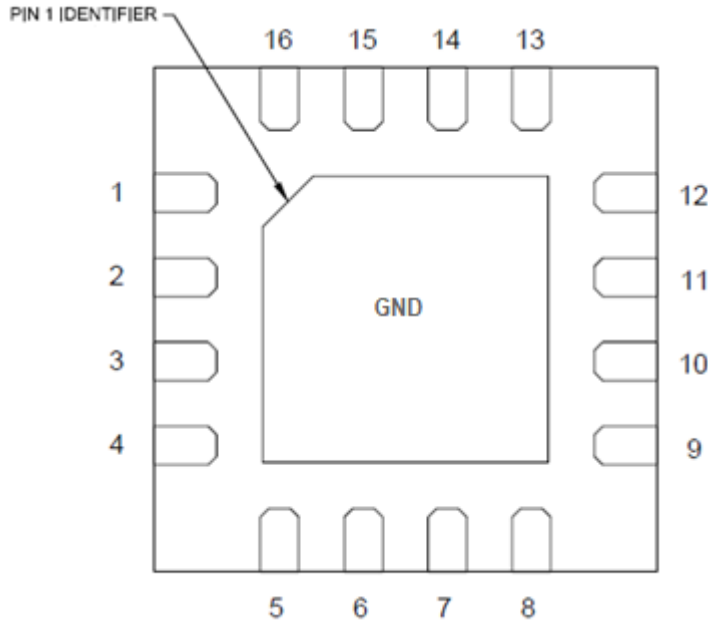

Pin Number	Label	Description
1,3,4,5,6,7,8,9,12,14,15,16	NC	Not connected internally. It may be left floating or connected to ground (preferred).
2	RFin	RF input. External DC blocking capacitor required.
10	CFB	Feedback capacitor
11	RFout/VDD	RF output. External bias choke to VDD required. External DC blocking capacitor required.
13	VG2	VG2 bias adjust. Set by resistor (R9) to ground.
Paddle	GND	DC/RF/Thermal/GND. (Maximize vias in this area)

Package Outline

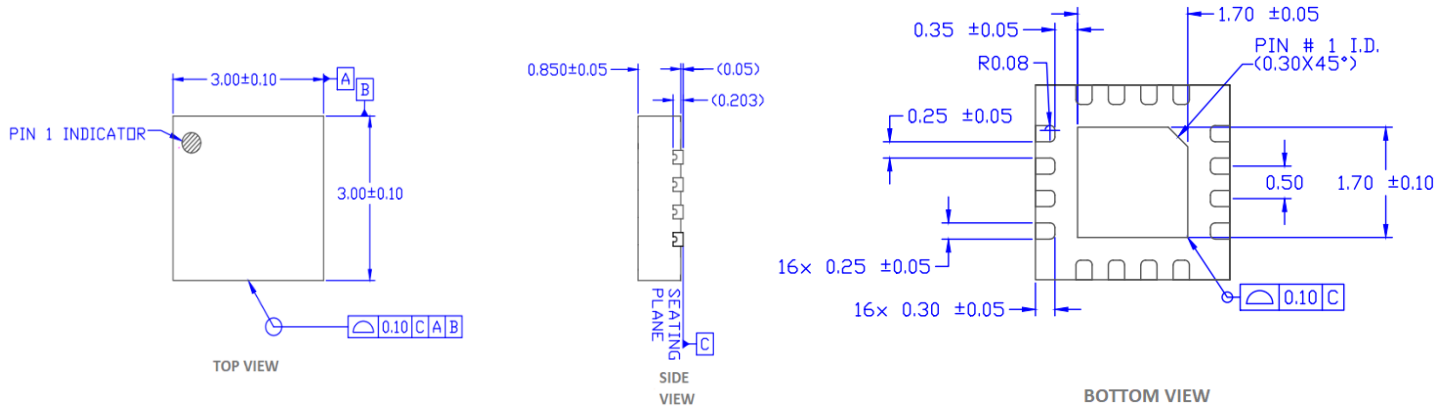

Recommended PCB Land Pattern

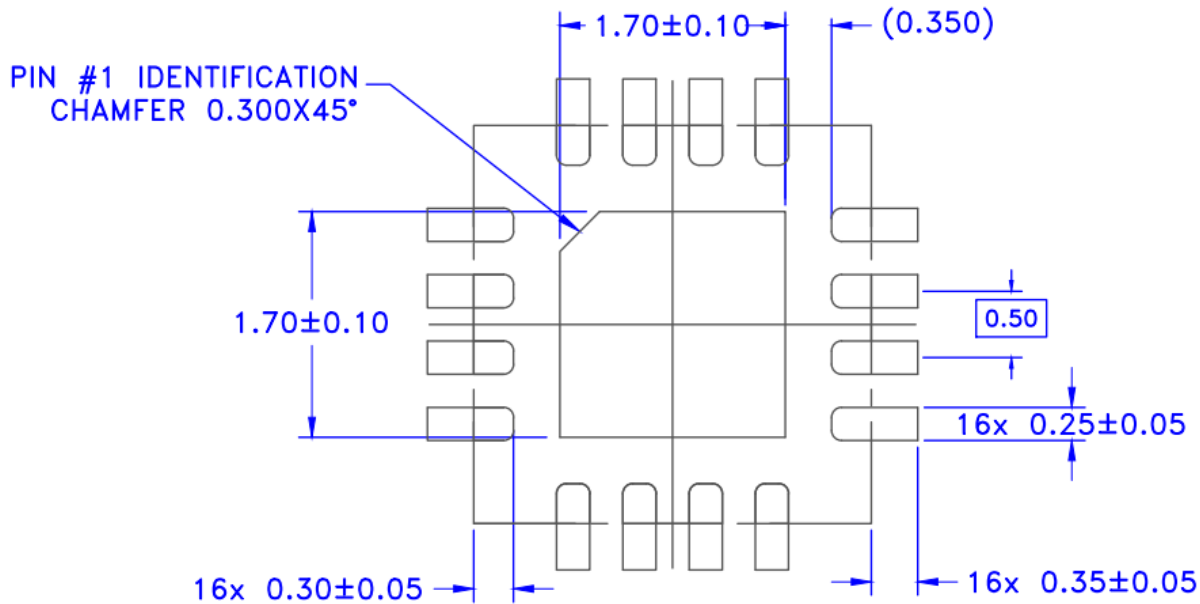

Package Marking

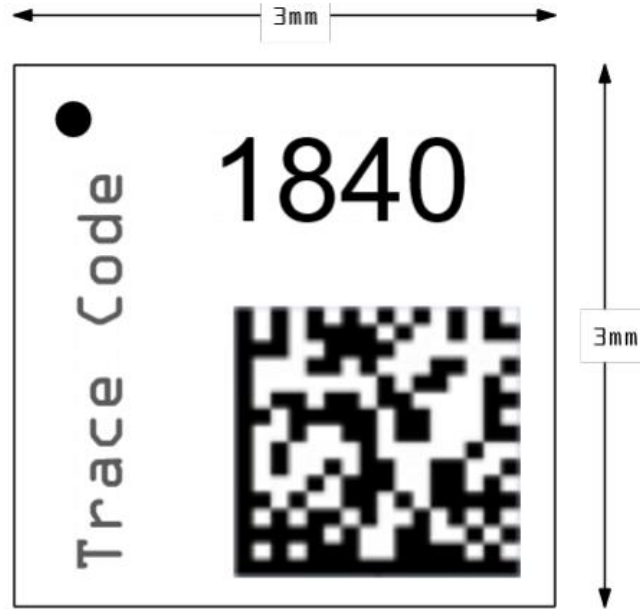

- Pin 1 Indicator
Trace Code to be assigned by SubCon

Tape and Reel

Table 1. Tape and Reel

Qorvo Part Number	Reel Diameter Inch (mm)	Hub Diameter Inch (mm)	Width (mm)	Pocket Pitch (mm)	Feed	Units Per Reel
QPL184018TR7	7 (178)	2.4 (61)	12	4	Single	2500

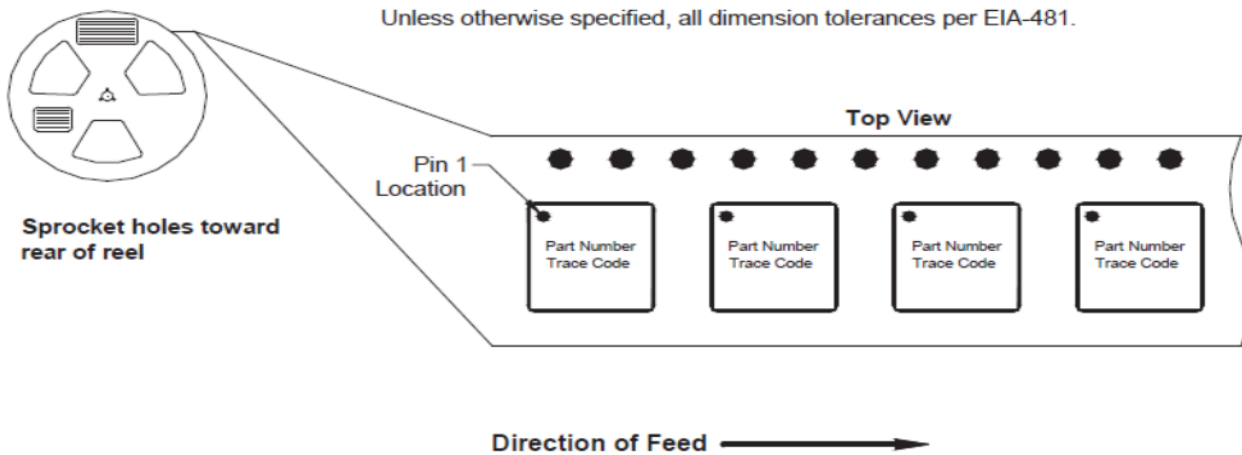

Handling Precautions

Parameter	Rating	Standard	 Caution! ESD Sensitive Device
ESD – Human Body Model (HBM)	Class 1B (500V to <1000V)	ANSI / ESDA / JEDEC JS-001	
ESD – Charged Device Model (CDM)	Class C3 (\geq 1000V)	ANSI / ESDA / JEDEC JS-002	
MSL – Moisture Sensitivity Level	MSL2	IPC / JEDEC J-STD-020	

Solderability

Compatible with both lead-free (260 °C max. reflow temp.) and tin / lead (245 °C max. reflow temp.) soldering processes. Solder profiles available upon request.

Contact plating: NiPdAu

RoHS Compliance

This part is compliant with 2011/65/EU RoHS directive (Restrictions on the Use of Certain Hazardous Substances in Electrical and Electronic Equipment) as amended by Directive 2015/863/EU.

This product also has the following attributes:

- PFOS Free
- Halogen Free (Chlorine, Bromine)
- Antimony Free
- TBBP-A (C₁₅H₁₂Br₄O₂) Free
- SVHC Free

Contact Information

For the latest specifications, additional product information, worldwide sales and distribution locations:

Web: www.qorvo.com

Tel: +1 844-890-8163

Email: customer.support@qorvo.com



Important Notice

The information contained in this Data Sheet and any associated documents (“Data Sheet Information”) is believed to be reliable; however, Qorvo makes no warranties regarding the Data Sheet Information and assumes no responsibility or liability whatsoever for the use of or reliance on said information. All Data Sheet Information is subject to change without notice. Customers should obtain and verify the latest relevant Data Sheet Information before placing orders for Qorvo® products. Information concerning Qorvo’s product life cycles is available at <https://www.qorvo.com/support/product-lifecycle-information>. Data Sheet Information or the use thereof does not grant, explicitly, implicitly or otherwise any rights or licenses with respect to patents or any other intellectual property whether with regard to such Data Sheet Information itself or anything described by such information.

Qorvo grants you permission to use this Data Sheet and any associated resources only to develop an application that uses the Qorvo products described in the Data Sheet and any associated resources. Other reproduction and display of this Data Sheet and any associated resources is prohibited.

Qorvo’s products are provided subject to Qorvo’s [Terms of Sale](#) or provided in conjunction with such Qorvo products. Qorvo objects to and rejects any additional or different terms customer may have proposed regarding the purchase of Qorvo products.

DATA SHEET INFORMATION DOES NOT CONSTITUTE A WARRANTY WITH RESPECT TO THE PRODUCTS DESCRIBED HEREIN, AND QORVO HEREBY DISCLAIMS ANY AND ALL WARRANTIES WITH RESPECT TO SUCH PRODUCTS WHETHER EXPRESS OR IMPLIED BY LAW, COURSE OF DEALING, COURSE OF PERFORMANCE, USAGE OF TRADE OR OTHERWISE, INCLUDING THE IMPLIED WARRANTIES OF MERCHANTABILITY AND FITNESS FOR A PARTICULAR PURPOSE. Without limiting the generality of the foregoing, Qorvo® products are not warranted or authorized for use as critical components in medical, life-saving, or life-sustaining applications, or other applications where a failure would reasonably be expected to cause severe personal injury or death. Applications described in the Data Sheet Information are for illustrative purposes only. Customers are responsible for validating that a particular product described in the Data Sheet Information is suitable for use in a particular application.

© 2025 Qorvo US, Inc. All rights reserved. This document is subject to copyright laws in various jurisdictions worldwide and may not be reproduced or distributed, in whole or in part, without the express written consent of Qorvo US, Inc.

QORVO® is a registered trademark of Qorvo US, Inc. All other trademarks and trade names are property of their respective owners.

Looking for pricing, stock, or lifecycle information?

Click below to explore more details on WIN SOURCE:

 [View QPL1840TR7 on WIN SOURCE](#)

 [Qorvo US Inc. Information](#)

Optimize Your Supply Chain with WIN SOURCE Solutions

-  Global Sourcing Solution
-  Obsolete Management
-  Cost Control Management
-  Shortage Management
-  Alternative Solution
-  Excess Inventory Management