



## MMIC SURFACE MOUNT

# Low Noise Amplifier

## TSS-14252LN+

50Ω 1427 to 2570 MHz Shutdown Feature

### THE BIG DEAL

- Ultra-Low Noise Figure, Typ. 0.8 dB
- High P1dB, Typ. +15.8 dBm
- High OIP3, Typ. +27.9 dBm
- High Input Power Handling, Max +21 dBm
- Shutdown Feature
- Single Supply Voltage, +3.3 V
- 3x3 mm 12-Lead QFN-Style Package

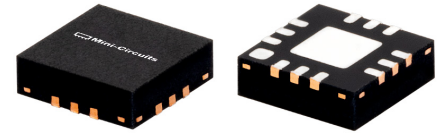

Generic photo used for illustration purposes only

### APPLICATIONS

- 5G MIMO Radio Systems
- Satellite Communications
- Radar, EW, and ECM Defense Systems

### FUNCTIONAL DIAGRAM

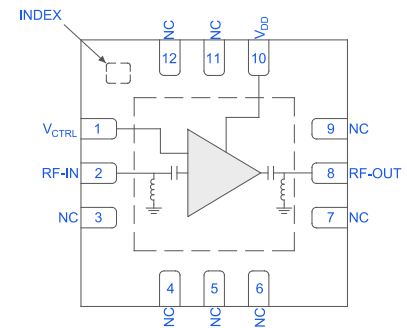

### PRODUCT OVERVIEW

The TSS-14252LN+ is a pHEMT-based wideband, ultra-low noise MMIC amplifier with high IP3, flat gain, and voltage-controlled shutdown capability. Operating from 1427 to 2570 MHz, this amplifier features typical 0.8 dB noise figure, 35.1 dB gain, +15.8 dBm P1dB, and +27.9 dBm OIP3. This combination of characteristics makes it ideal for sensitive receiver applications. The device is internally DC blocked and a DC path to ground is present at the RF input and output ports for ESD protection. TSS-14252LN+ operates on a single +3.3 V supply and comes in a small, low profile, 3x3 mm QFN-style package for ease of integration into dense circuit board layouts.

### KEY FEATURES

Features	Advantages
Ultra-Low Noise Figure, Typ. 0.8 dB	Operating from a single supply, this ultra-low noise MMIC enables low system noise figure performance, without the need for complicated discrete-based solutions.
High Gain, Typ. 35.1 dB	The MMIC amplifier's high gain enables fewer system components in receiver signal chains.
Shutdown Feature	A voltage-controlled shutdown feature allows the part to be quickly disabled to conserve power when not in use.
3x3 mm 12-Lead QFN-Style Package	Small footprint saves space in dense layouts while providing low inductance, repeatable transitions, and excellent thermal contact to the PCB. Industry standard packaging allows for ease of assembly in high volume manufacturing processes.



MMIC SURFACE MOUNT

## Low Noise Amplifier

TSS-14252LN+

Mini-Circuits

50Ω 1427 to 2570 MHz Shutdown Feature

ELECTRICAL SPECIFICATIONS<sup>1</sup> AT 25°C, V<sub>DD</sub> = +3.3 V

Parameter	Condition (MHz)	Amplifier - ON (V <sub>CTRL</sub> = 0 V)			Amplifier - OFF (V <sub>CTRL</sub> = +1.5 V)	Units
		Min.	Typ.	Max.	Typ.	
Frequency Range		1427		2570	1427 - 2570	MHz
Gain	1427	34.8	36.7		-46.5	dB
	2020	33.2	35.1		-34.4	
	2570	32.0	33.7		-29.0	
Input Return Loss	1427		19			dB
	2020		20			
	2570		20			
Output Return Loss	1427		20			dB
	2020		15			
	2570		18			
Isolation	1427-2570		53		35	dB
Output Power at 1dB Compression (P1dB)	1427		+15.1			dBm
	2020		+15.8			
	2570		+14.9			
Output Third-Order Intercept Point (P <sub>OUT</sub> = 0dBm/Tone)	1427		+27.6			dBm
	2020		+27.9			
	2570		+26.7			
Noise Figure	1427		0.9			dB
	2020		0.8			
	2570		0.9			
ON Time (50% V <sub>CTRL</sub> to 90% RF)			100.4			ns
RISE Time (10% RF to 90% RF)			52.8			ns
FALL Time (90% RF to 10% RF)			16.6			ns
OFF Time (50% V <sub>CTRL</sub> to 10% RF)			22.6			ns
Device Operating Voltage (V <sub>DD</sub> )		+3	+3.3	+3.5	+3.3	V
Device Operating Current (I <sub>DD</sub> ) <sup>2</sup>			64	75	0	mA
Device Control Voltage (V <sub>CTRL</sub> )			0		+1.5	V
Device Control Current (I <sub>CTRL</sub> )			3		4	mA
DC Current Variation vs. Temperature <sup>3</sup>			-16.7			μA/°C
DC Current Variation vs. Voltage <sup>4</sup>			41.2			μA/mV

1. Tested on Mini-Circuits Characterization Test Board TB-TSS14252C+. See Figure 2. Board loss de-embedded to the device.

2. Current at P<sub>IN</sub> = -35 dBm.

3. (Current at +105°C - Current at -45°C) / (+150°C)

4. (Current at +3.5 V - Current at +3.0 V) / (+0.5 V)





### TYPICAL PERFORMANCE GRAPHS

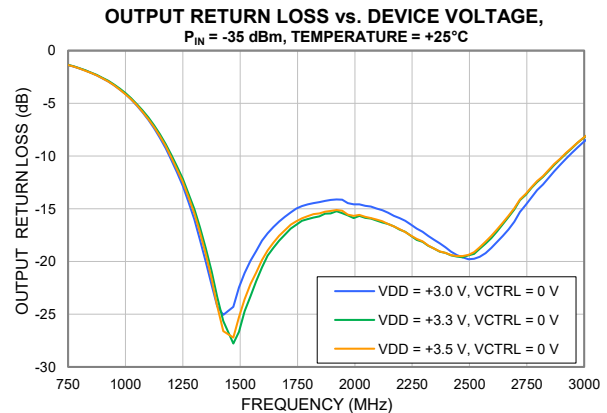
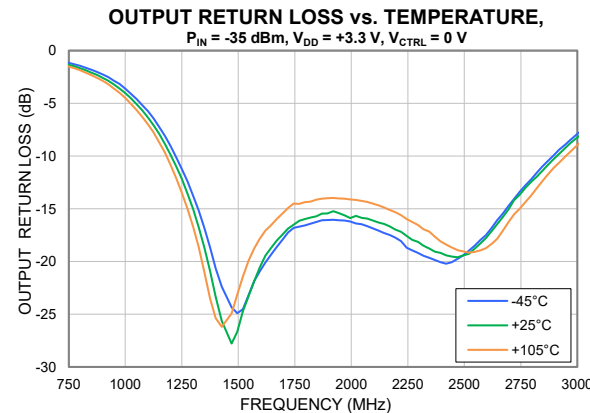
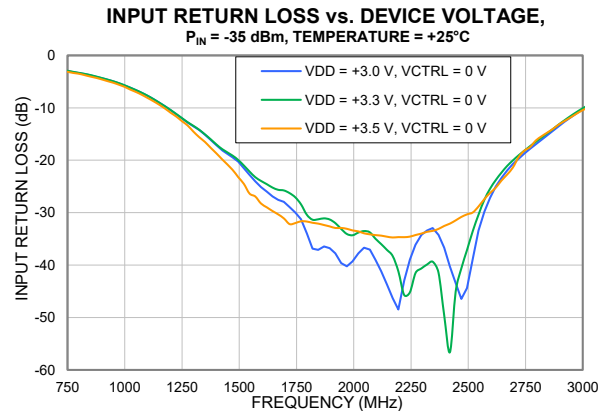
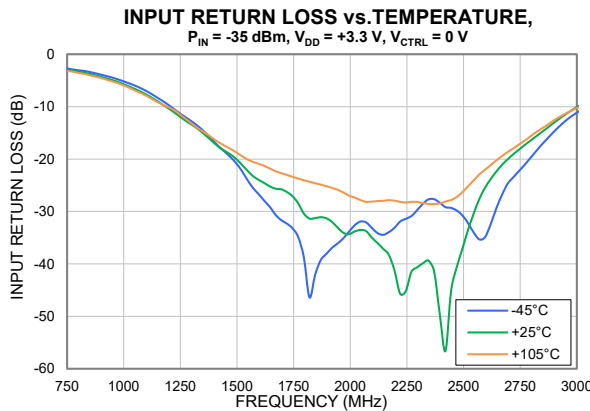
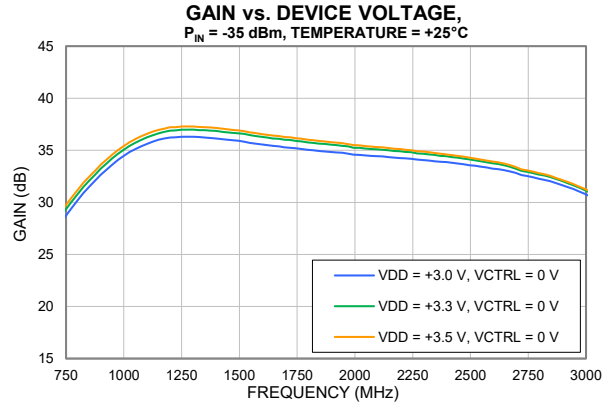
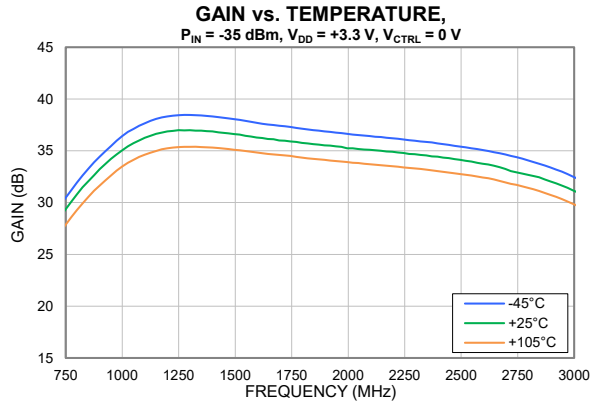



### TYPICAL PERFORMANCE GRAPHS

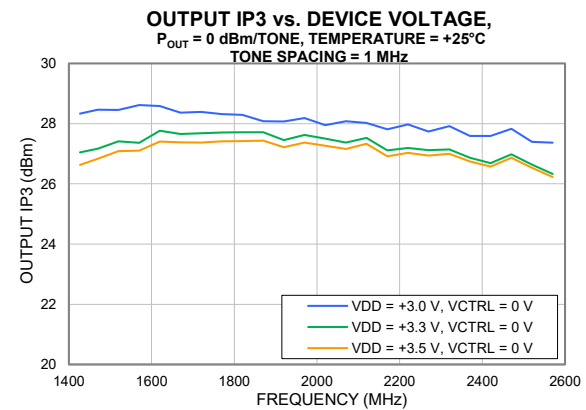
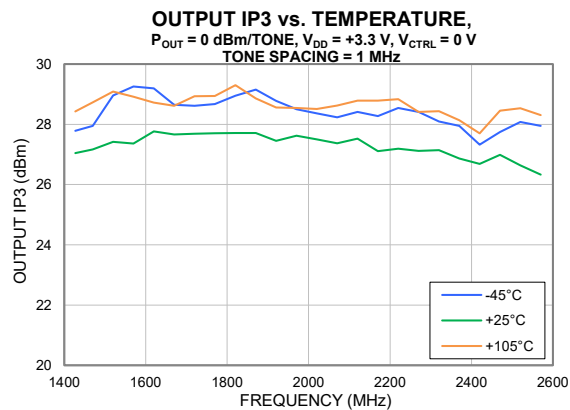
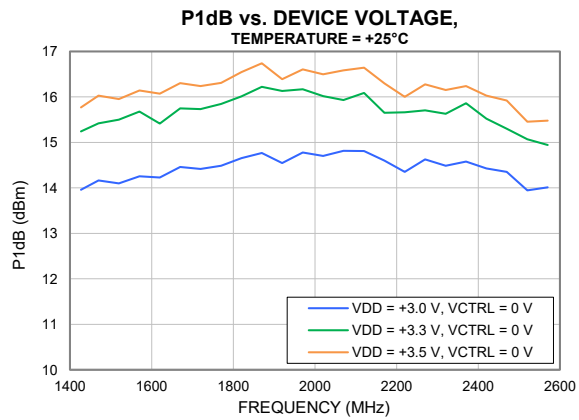
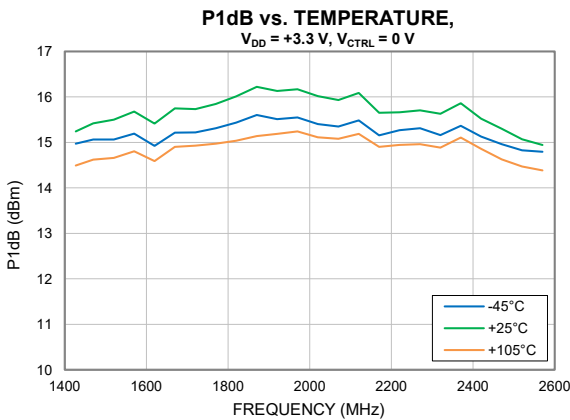
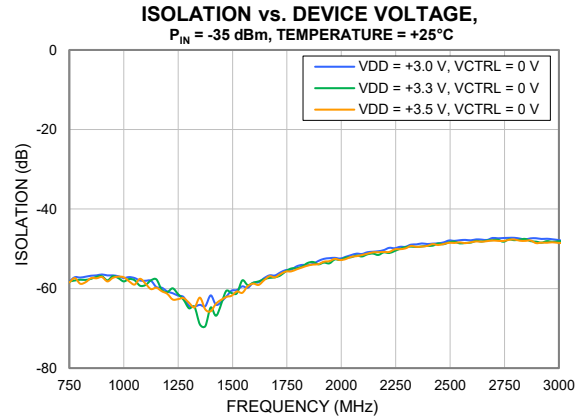
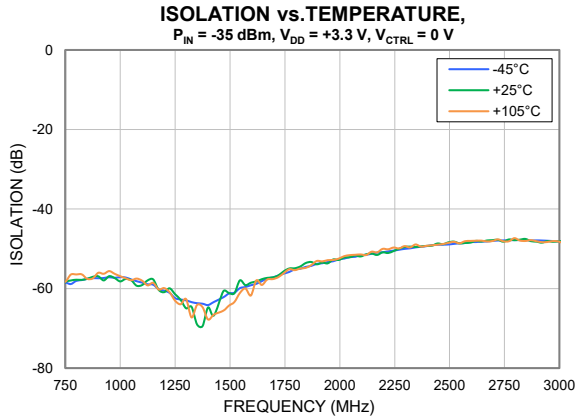



### TYPICAL PERFORMANCE GRAPHS

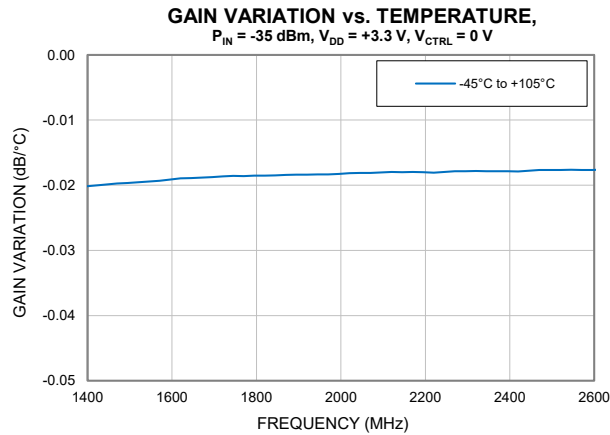
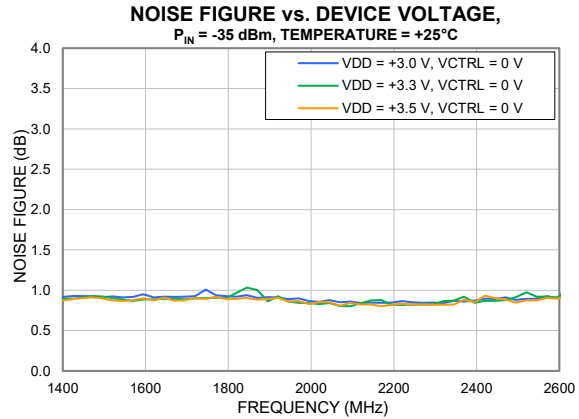
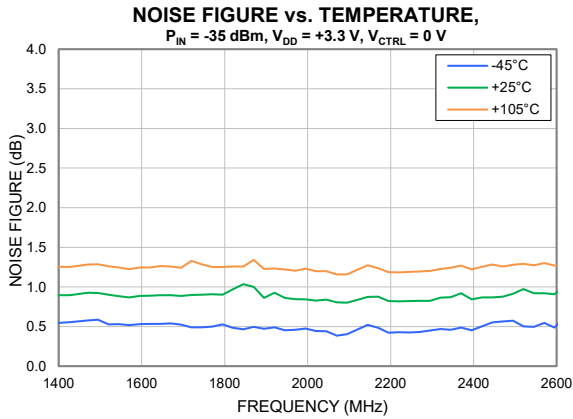



MMIC SURFACE MOUNT

# Low Noise Amplifier

## TSS-14252LN+

Mini-Circuits

50Ω 1427 to 2570 MHz Shutdown Feature

### ABSOLUTE MAXIMUM RATINGS<sup>5</sup>

Parameter	Ratings
Operating Temperature	-45°C to +105°C
Storage Temperature	-65°C to +150°C
Junction Temperature <sup>6</sup>	+150°C
Total Power Dissipation	0.63 W
Input Power (CW), $V_{DD} = +3.3\text{ V}$ $V_{CTRL} = 0\text{ V}$ :	+21 dBm
DC Voltage at $V_{DD}$ $V_{CTRL} = 0\text{ V}$ :	+5 V
$V_{CTRL} = +1.5\text{ V}$ :	+5 V
DC Current $I_{DD}$ $V_{CTRL} = 0\text{ V}$ :	150 mA
$V_{CTRL} = +1.5\text{ V}$ :	20 mA
DC Voltage at $V_{CTRL}$ $V_{DD} = +3.3\text{ V}$ :	+5 V
DC Current $I_{CTRL}$ $V_{DD} = +3.3\text{ V}$ :	10 mA

5. Permanent damage may occur if any of these limits are exceeded. Maximum ratings are not intended for continuous normal operation.

6. Peak temperature on top of Die.

### CONTROL VOLTAGE ( $V_{CTRL}$ )

Amplifier State	Min.	Typ.	Max.	Units
Amplifier – ON	0	0	+0.2	V
Amplifier – OFF	+1	+1.5	+5	V

### THERMAL RESISTANCE

Parameter	Ratings
Thermal Resistance ( $\theta_{JC}$ ) <sup>7</sup>	71.9°C/W

7.  $\theta_{JC}$  = (Hot Spot Temperature on Die - Temperature at Ground Lead)/Dissipated Power

### ESD RATING

	Class	Voltage Range	Reference Standard
HBM	1A	250 V to < 500 V	ANSI/ESDA/JEDEC JS-001-2023
CDM	C3	≥ 1000 V	ANSI/ESDA/JEDEC JS-002-2022



ESD HANDLING PRECAUTION: This device is designed to be Class 1A for HBM. Static charges may easily produce potentials higher than this with improper handling and can discharge into DUT and damage it. As a preventive measure Industry standard ESD handling precautions should be used at all times to protect the device from ESD damage.

### MSL RATING

Moisture Sensitivity: MSL1 in accordance with IPC/JEDEC J-STD-020E /JEDEC J-STD-033C





### FUNCTIONAL DIAGRAM

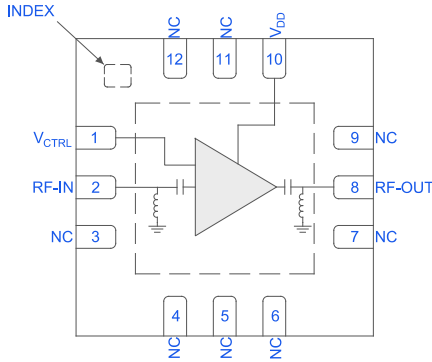

Figure 1. TSS-14252LN+ Functional Diagram

### PAD DESCRIPTION

Function	Pad Number	Application Description (Refer to Figure 2)
V <sub>CTRL</sub>	1	DC Input Pad connects to control voltage port V <sub>CTRL</sub> .
RF-IN	2	RF-IN Pad connects to RF Input port.
RF-OUT	8	RF-OUT Pad connects to RF Output port.
V <sub>DD</sub>	10	DC Input Pad connects to voltage input port V <sub>DD</sub> .
NC	3-7,9,11	Not used internally. Connected to ground on test board.
NC <sup>s</sup>	12	Do not connect to ground on PCB. Pad is used internally.
GND	Paddle, INDEX	Connects to ground.

8. Pin 12 is used internally within the package. Connecting this Pin externally can cause permanent damage to the device.

### CHARACTERIZATION TEST BOARD

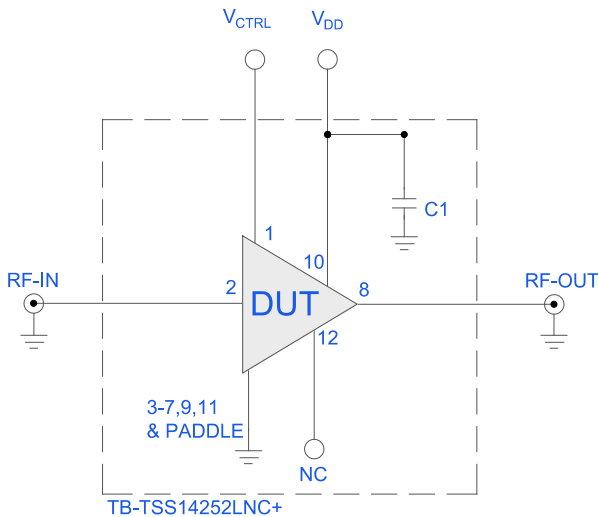

Figure 2. TSS-14252LN+ Characterization and Application Circuit.

### Electrical Parameters and Conditions

Gain, Return Loss, Output Power at 1dB Compression (P1dB), Output IP3 (OIP3), and Noise Figure measured using N5242A PNA-X microwave network analyzer.

Conditions:

- 1) Gain and Return Loss: P<sub>IN</sub> = -35 dBm
- 2) Output IP3 (OIP3): Two tones, spaced 1 MHz apart, 0 dBm/Tone at output.
- 3) V<sub>DD</sub> = +3.3 V

Component	Value	Size	Part Number	Manufacturer
C1	1 μF	0402	GRM155C81E105KE11D	Murata

Power ON/Power OFF Sequence:

Caution: Permanent damage to the device will occur if the Power ON and Power OFF sequences are not followed.

POWER ON:

- 1) Set V<sub>DD</sub> to +3.3 V
- 2) Turn on V<sub>DD</sub>
- 3) Set V<sub>CTRL</sub> to 0 V
- 4) Turn on V<sub>CTRL</sub>
- 5) Apply RF Signal.

POWER OFF:

- 1) Turn off RF Signal.
- 2) Turn off V<sub>CTRL</sub>
- 3) Turn off V<sub>DD</sub>



### CASE STYLE DRAWING

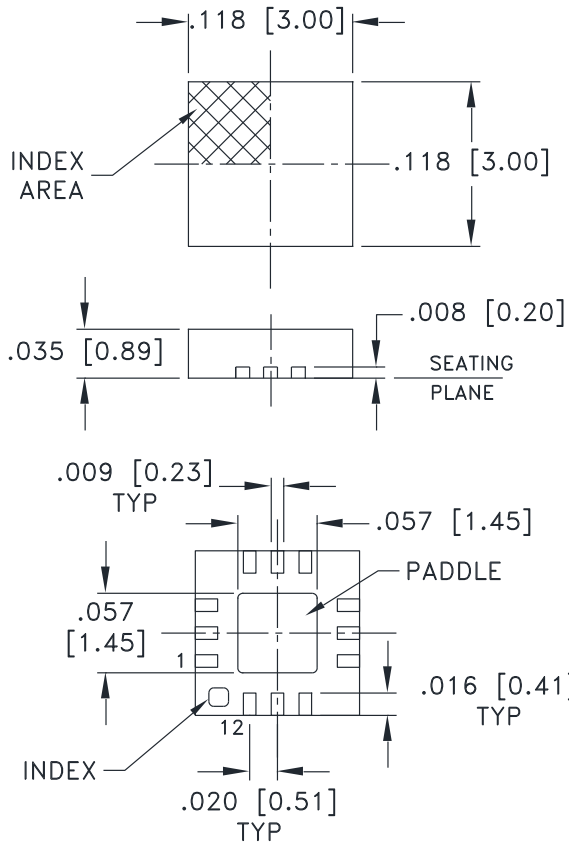

### PCB Land Pattern

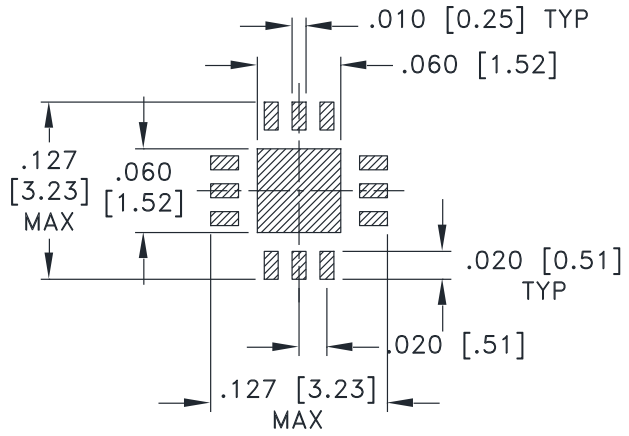

SUGGESTED LAYOUT,  
TOLERANCE TO BE WITHIN ±.002

Weight: .02 Grams

Dimensions are in inches [mm]. Tolerances in inches: 2 Pl. ±.01; 3 Pl.±.004 inches

### PRODUCT MARKING

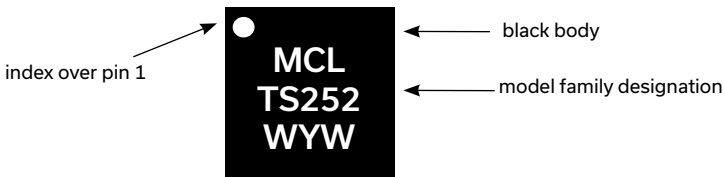

Marking may contain other features or characters for internal lot control



MMIC SURFACE MOUNT

# Low Noise Amplifier

## TSS-14252LN+

50Ω 1427 to 2570 MHz Shutdown Feature

ADDITIONAL DETAILED INFORMATION IS AVAILABLE ON OUR DASHBOARD

[CLICK HERE](#)

Performance Data & Graphs	Data Graphs S-Parameter (S2P Files) Data Set (.zip file)
Case Style	DQ1225 Plastic package, exposed paddle, Lead Finish: Matte-Tin
RoHS Status	Compliant
Tape & Reel Standard quantities available on reel	F66 7" reels with 20, 50, 100, 200, 500, 1K, 2K, or 3K devices
Suggested Layout for PCB Design	PL-806
Evaluation Board	TB-TSS14252LNC+ Gerber File
Environmental Ratings	ENV08T1

### NOTES

- A. Performance and quality attributes and conditions not expressly stated in this specification document are intended to be excluded and do not form a part of this specification document.
- B. Electrical specifications and performance data contained in this specification document are based on Mini-Circuits' applicable established test performance criteria and measurement instructions.
- C. The parts covered by this specification document are subject to Mini-Circuits standard limited warranty and terms and conditions (collectively, "Standard Terms"); Purchasers of this part are entitled to the rights and benefits contained therein. For a full statement of the standard terms and the exclusive rights and remedies thereunder, please visit Mini-Circuits' website at [www.minicircuits.com/terms/viewterm.html](http://www.minicircuits.com/terms/viewterm.html)



## Looking for pricing, stock, or lifecycle information?

Click below to explore more details on WIN SOURCE:

 [View TSS-14252LN+ on WIN SOURCE](#)

 [Mini-Circuits Information](#)

## Optimize Your Supply Chain with WIN SOURCE Solutions

-  Global Sourcing Solution
-  Obsolete Management
-  Cost Control Management
-  Shortage Management
-  Alternative Solution
-  Excess Inventory Management