

Product Overview

The QPL8831 is an ultra-linear GaAs pHEMT 75-Ohm RF balanced amplifier IC with 5 – 1218 MHz operating bandwidth, featuring high linearity, high gain and low noise for use as a post amplifier in optical receivers or as a low noise balanced preamp. This IC uses a 5V supply for applications requiring lower power dissipation or can operate from 8V supplies when higher output is needed. Due to its wide operational bandwidth, the QPL8831 can be used as a downstream amp in DOCSIS 3.1 as well as an upstream amplifier for DOCSIS 3.1 or DOCSIS 4.0 applications.



8-Pin SOIC Package

Functional Block Diagram

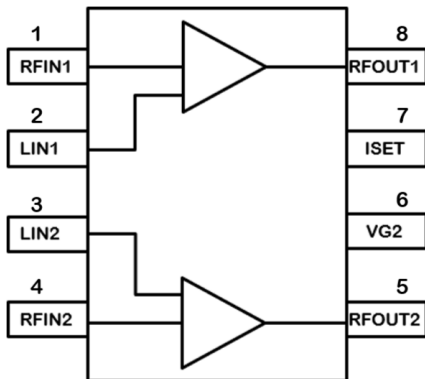

Key Features

- High Gain: 17dB at 1218 MHz
- 5 – 1218 MHz BW
- OIP3: +46 dBm, 50 – 1218 MHz
- OP1dB: +25 dBm, 50 – 1218 MHz
- Low Noise Figure: 3.1 dB, Full Band
- Excellent Composite Distortion
- pHEMT GaAs device technologies
- Compact Size: 8-pin SOIC
- Power Consumption:
 - 5 V, 280 mA (1.4 W)
 - 8 V, 360 mA (2.9 W)

Ordering Information

Part Number	Description
QPL8831SB	Sample bag with 5 pieces
QPL8831SR	7" Reel with 100 pieces
QPL8831TR13	13" Reel with 2500 pieces
QPL8831PCK-01	50 – 1218 MHz 5V Evaluation Board with 5 pc sample bag
QPL8831EVB-02	5 – 700 MHz Evaluation Board, 5 V
QPL8831EVB-03	50 – 1218 MHz Evaluation Board, 8 V
QPL8831EVB-04	5 – 700 MHz Evaluation Board, 8 V

Applications

- DOCSIS 3.1 Systems
- Balanced Antenna Applications
- HFC Optical Nodes
- 75 Ω Amplifiers
- Upstream Amplifier for DOCSIS 3.1 and DOCSIS 4.0 Applications

Absolute Maximum Ratings

Parameter	Rating
Supply Voltage (V_{DD})	+10 V
Supply Current (I_{DD})	400 mA
Maximum Input Level (single tone)	+15 dBm
Operating Temperature Range (Bottom of Case)	-40 to +100 °C
Storage Temperature Range	-40 to +150 °C
Maximum Junction Temperature	+150 °C

Exceeding any one or a combination of the Absolute Maximum Rating conditions may cause permanent damage to the device. Extended application of Absolute Maximum Rating conditions to the device may reduce device reliability.

Electrical Specifications; 50 – 1218MHz, 5V

Parameter	Condition ⁽¹⁾	Min	Typ	Max	Unit
Supply Voltage (V_{DD})			5		V
Supply Current (I_{DD})			280		mA
Frequency Range		5		1218	MHz
Gain			17		dB
Gain Flatness			±0.5		dB
Input Return Loss			18		dB
Output Return Loss			20		dB
Noise Figure			3.1		dB
OIP2L	+13 dBm / tone, $\Delta f = 50$ MHz		73		dBm
OIP2H	+13 dBm / tone, $\Delta f = 50$ MHz		59		dBm
OIP3	+13 dBm / tone, $\Delta f = 6$ MHz		46		dBm
Output P1dB			25.1		dBm
MER	$V_o = 65.2$ dBmV Total Composite Output Power 54-1218 MHz 195Ch 256QAM, 0 dB Tilt, ITU-T J.83/B		45		dB
Thermal Resistance	Bottom of Case		13		°C/W

Notes:

1. Typical performance at these conditions: Temp = +25 °C, $V_{DD} = +5$ V, 75 Ω system, Full band unless otherwise noted.

Electrical Specifications; 50 – 1218MHz, 8V

Parameter	Condition ⁽¹⁾	Min	Typ	Max	Unit
Supply Voltage (V _{DD})			8		V
Supply Current (I _{DD})			360		mA
Frequency Range		5		1218	MHz
Gain			17.2		dB
Gain Flatness			±0.5		dB
Input Return Loss			19		dB
Output Return Loss			18		dB
Noise Figure			3.3		dB
OIP2L	+13 dBm / tone, Δf = 50 MHz		76		dBm
OIP2H	+13 dBm / tone, Δf = 50 MHz		59		dBm
OIP3	+13 dBm / tone, Δf = 6 MHz		45		dBm
Output P1dB			28.7		dBm
MER	V _o = 69.1 dBmV Total Composite Output Power 54-1218 MHz 195Ch 256QAM, 0 dB Tilt, ITU-T J.83/B		45		dB
Thermal Resistance	Bottom of Case		13		°C/W

Notes:

1. Typical performance at these conditions: Temp = +25 °C, V_{DD} = +8V, 75 Ω system, Full band unless otherwise noted.

Evaluation Board Schematic; 50 – 1218 MHz, 5V

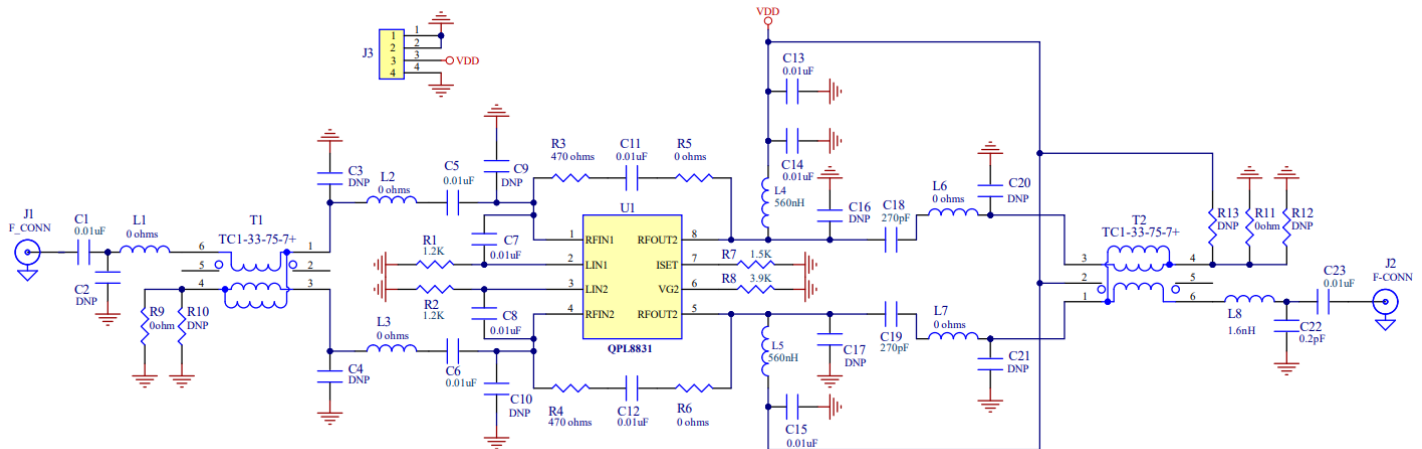

Bill of Material of Evaluation Board: 50 – 1218 MHz, 5V

Reference Designator	Description	Manufacturer	Part Number
U1	5 - 1218 MHz, 17 dB Push-Pull Amp	Qorvo	QPL8831SB
PCB	EVB PCB, QPL8831	Qorvo	QPL883x-4001
C22	CAP, 0.2pF, +/-0.1pF, 50V, HI-Q, 0402	Murata	GJM1555C1HR20B01D
C1,C5,C6,C7,C8,C11,C12,C13,C14,C15,C23	CAP, 0.01uF, 10%, 50V, X7R, 0402	Murata	GCM155R71H103KA55D
C18, C19	CAP, 270pF, 5%, 50V, C0G, 0402	Murata	GCM1555C1H271JA16D
L1, L2, L3, L6, L7, R5, R6, R9, R11	RES, 0 OHM, 1/10W, 0402	Kamaya	RMC1/16SJPTH
R7	RES, 1.5K, 5%, 1/16W, 0402	Kamaya	RMC1/16S-152JTH
R8	RES, 3.9K, 5%, 1/16W, 0402	Kamaya	RMC1/16S-392JTH
R3, R4	RES, 470 OHM, 5%, 1/16W, 0402	Kamaya	RMC1/16S-471JTH
R1, R2	RES, 1.2K, 5%, 1/16W, 0402	Kamaya	RMC1/16S-122JTH
L4, L5	IND, 560nH, 5%, 550mA, W/W, 0603	Coilcraft	0603LS-561XJRC
L8	IND, 1.6nH, ±0.1nH, 1000mA, M/L, 0402	Murata	LQG15HS1N6B02D
T1, T2	TRANSFORMER, 1:1	Mini Circuits	TC1-33-75-7+
J3	CONN, HDR	Samtec	TSW-104-08-S-S
J1, J2	CONN, F FEM, 75OHM	MM Wave	MW-846-C-DD-75
HS	HEATSINK BLOCK, 1.5 X 2.0 IN	Shenzhen Minxingda	EEF-105441
S1-4	SCREW, 2-56X3/16"	McMaster-Carr	92196A076
C2, C3, C4, C9, C10, C16, C17, C20, C21, R10, R12, R13	DNP		

8V BOM Changes:

Reference Designator	Description	Manufacturer	Part Number
R1, R2	RES, 2K, 5%, 1/16W, 0402	Kamaya	RMC1/16S-202JTH
R7	RES, 768 OHM, 1%, 1/16W, 0402	Vishay	CRCW0402768RFKED

Evaluation Board Layout

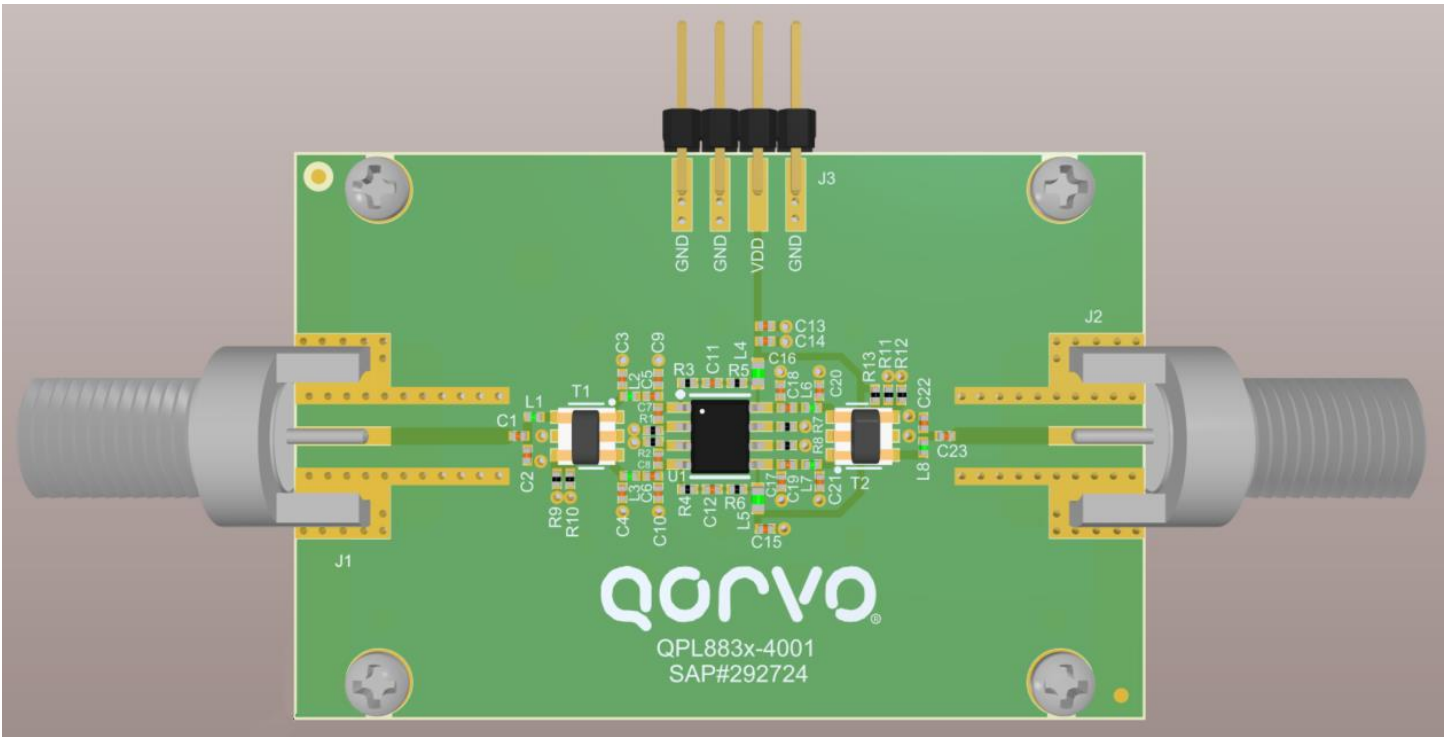

EVB PCB Material and Stack-up

Board Material: 59.8mil FR4, $\epsilon_r=4.3$
 Plating: 1/2 oz plus final plating
 Board Dimension: 2.250" x 1.500"

Layer	Name	Material	Thickness	Constant	Board Layer Stack
	Top Overlay				
	Top Solder	SM-001	0.40mil	3.5	
1	Top Layer	CF-004	0.70mil		
	Dielectric 1	FR4	58.00mil	4.3	
2	Bottom Layer	CF-004	0.70mil		

Total Thickness: 61.2mil

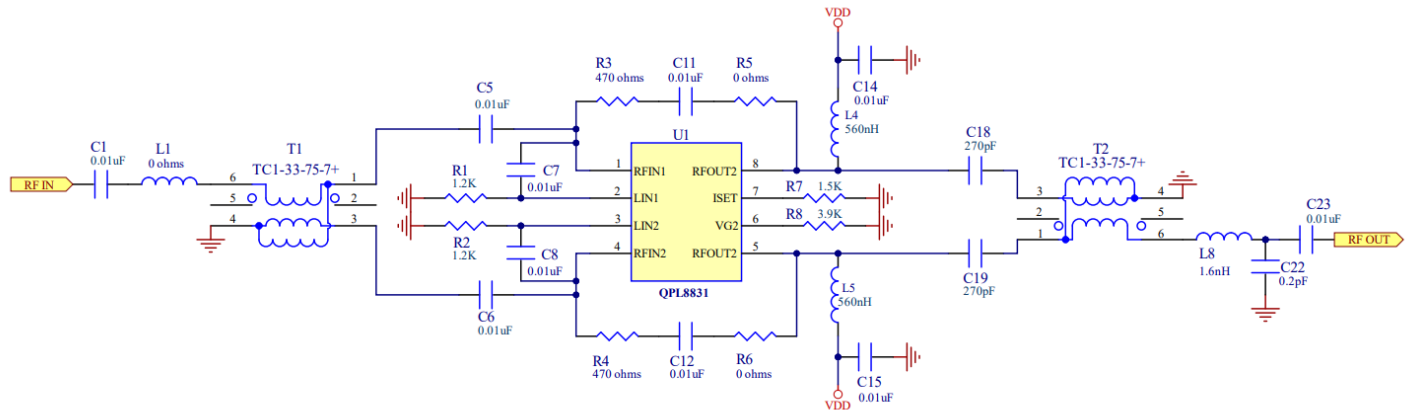
Typical Application Schematic; 50 – 1218 MHz, 5V

R3, R5 and R4, R6 form the feedback along with the DC blocking caps, C11 and C12. Increasing resistance increases gain while decreasing resistance will reduce gain. Changes to the total feedback resistance will impact return loss and may require retuning the match. L4, L5 are bias chokes for RF decoupling to the power supply. C1, C2 (DNP), and L1 affect the input match, as well as L2 and L3 (DNP). L8 and C22 are used for output matching. C18 and C19 are DC blocking caps, but are also tuned to improve low end return loss. T1 and T2 are 1:1 tertiary baluns suitable for downstream or upstream use. R1, R2, C7 and C8 form the Linearizer bias circuit and are described in more detail on pg 25. R7 sets the device current, while R8 sets the gate voltage of the output stage (refer to pg 25 for further details).

Pin Configuration and Description

Pin	Name	Description
1	RFIN1	RF input for plus side of amplifier
2	LIN1	Linearizer current set for plus side of amplifier
3	LIN2	Linearizer current set for minus side of amplifier
4	RFIN2	RF input for minus side of amplifier
5	RFOUT2	RF output for minus side of amplifier; DC bias required
6	VG2	Output stage gate voltage adjust
7	ISET	IDD Adjust
8	RFOUT1	RF output for plus side of amplifier; DC bias required
9	GND	Exposed bottom of part, device ground

Performance Data; 50 – 1218 MHz, 5V

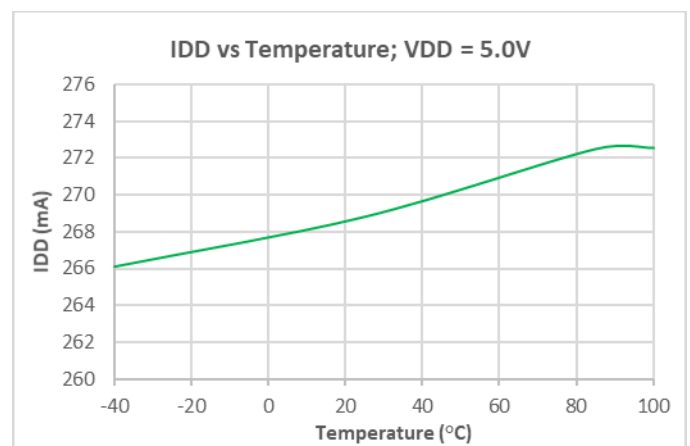
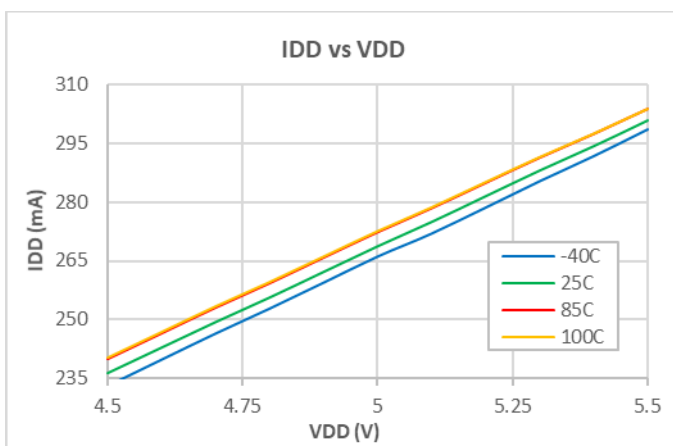
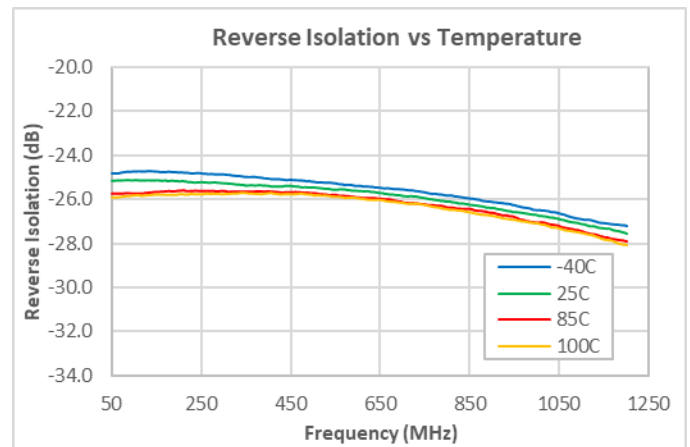
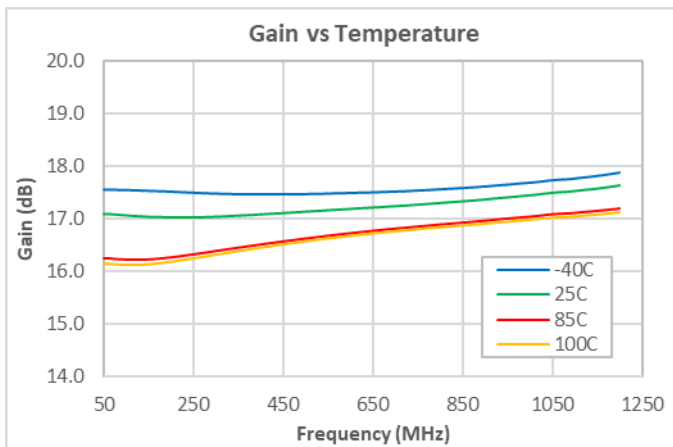
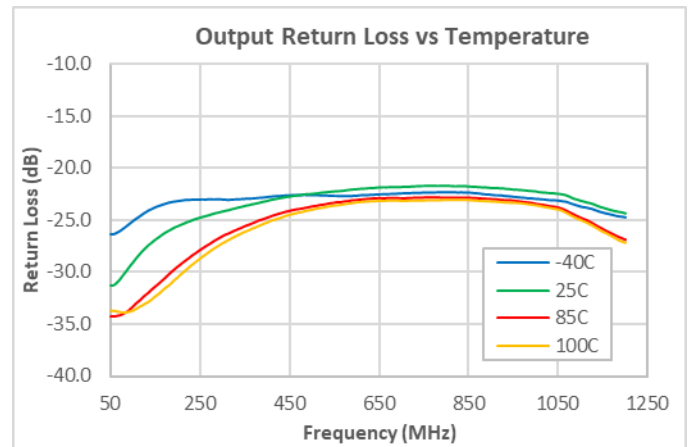
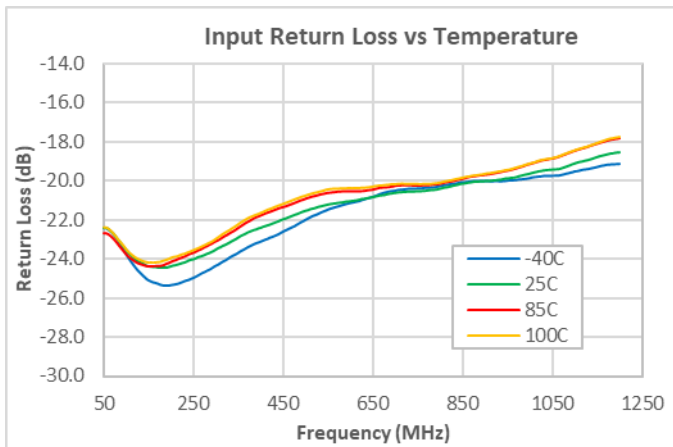

Notes:

1. Test conditions unless otherwise noted: VDD: 5V, Zo = 75Ω.

Performance Data; 50 – 1218 MHz, 5V

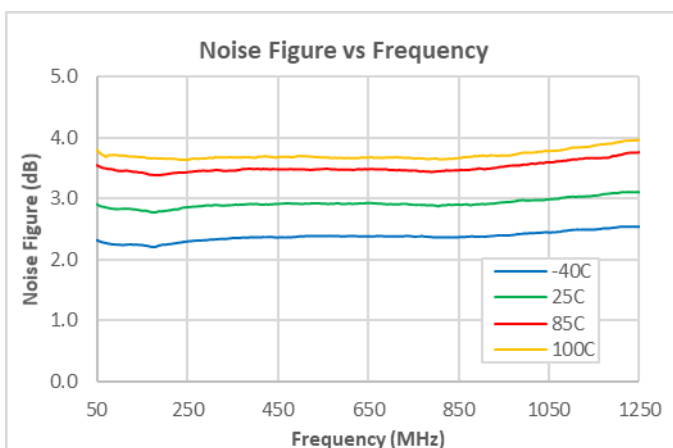
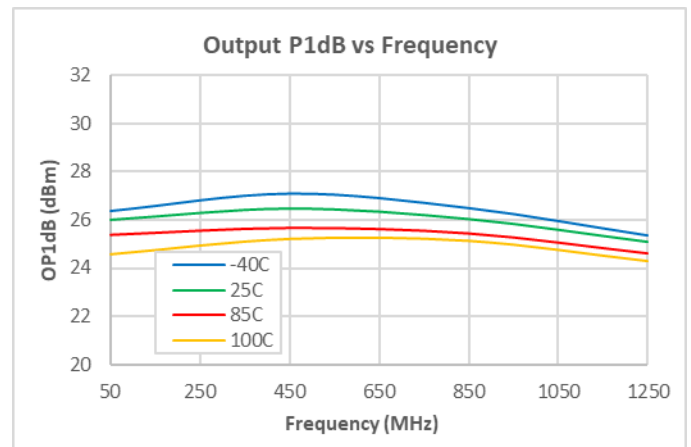
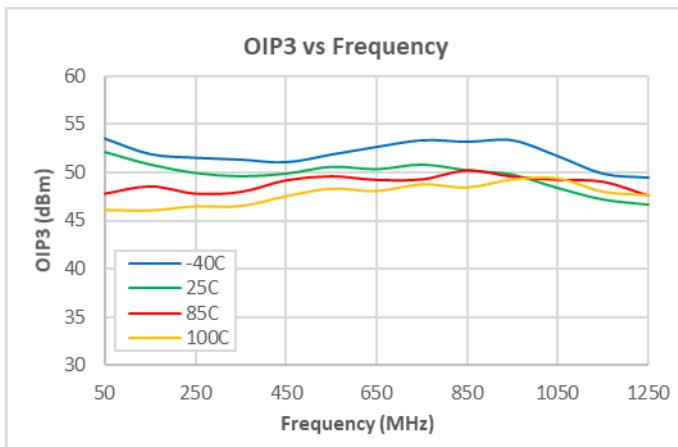
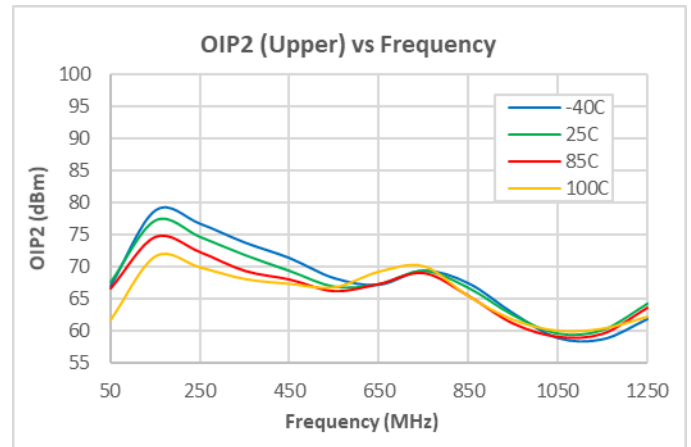
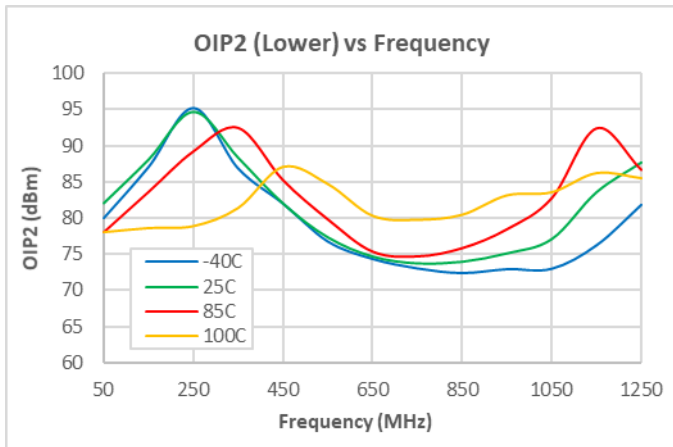

Notes:

1. Test conditions unless otherwise noted: VDD: 5V, $Z_o = 75\Omega$.
2. OIP2: 13 dBm / tone output, $\Delta f = 50$ MHz, 50-1218 MHz.
3. OIP3: 13 dBm / tone output, $\Delta f = 6$ MHz, 50-1218 MHz.

Performance Data; 50 – 1218 MHz, 0dB Tilt, 5V

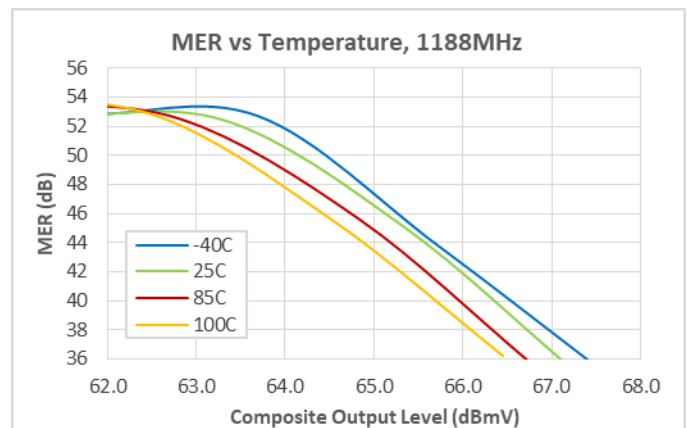
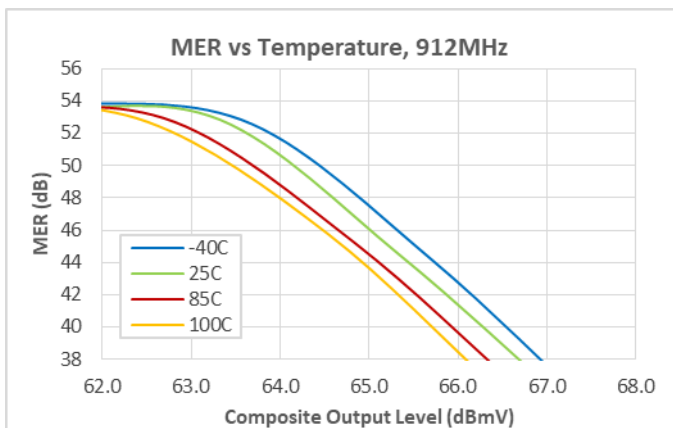
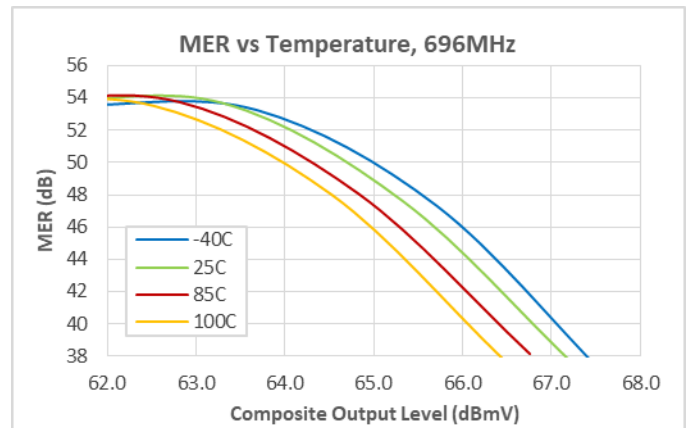
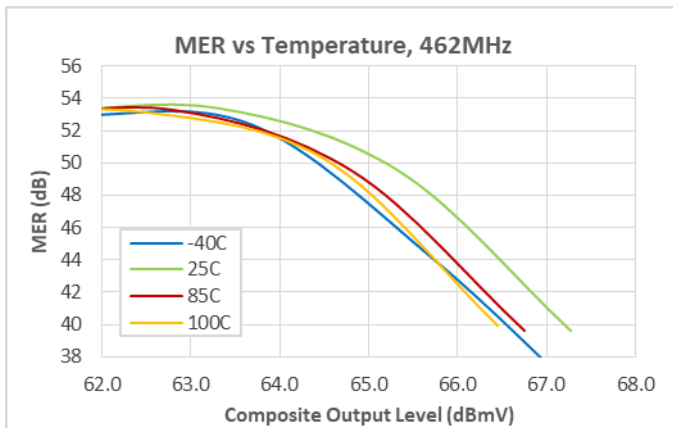
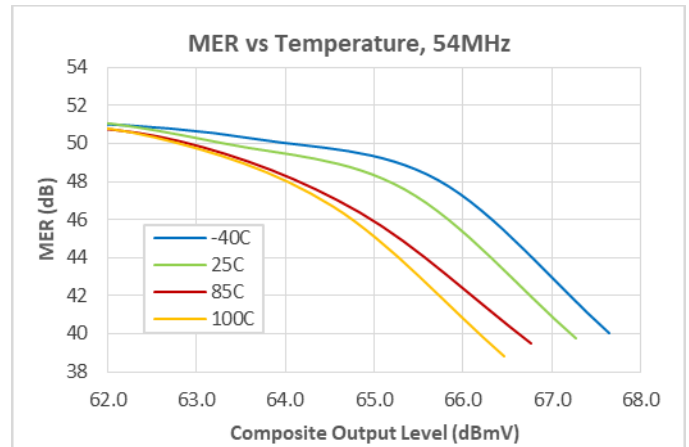
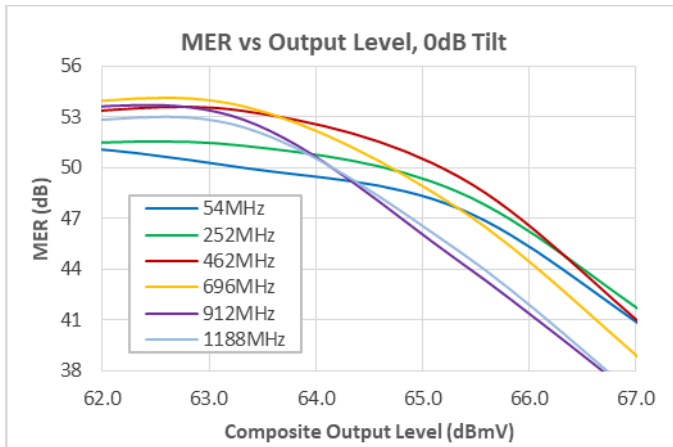

Notes:

1. Test conditions unless otherwise noted: VDD: 5V, $Z_o = 75\Omega$.
2. MER, Source Corrected, Maximum Correction 4.3dB, 54-1218MHz 256QAM, ITU-T J.83, Annex B

Performance Data; 50 – 1218 MHz, 10dB Tilt, 5V

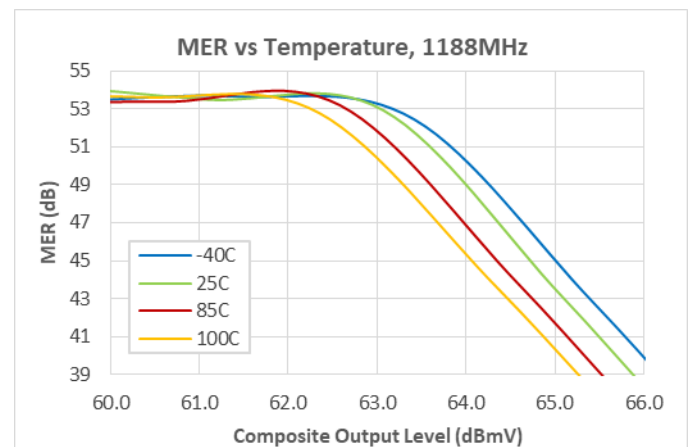
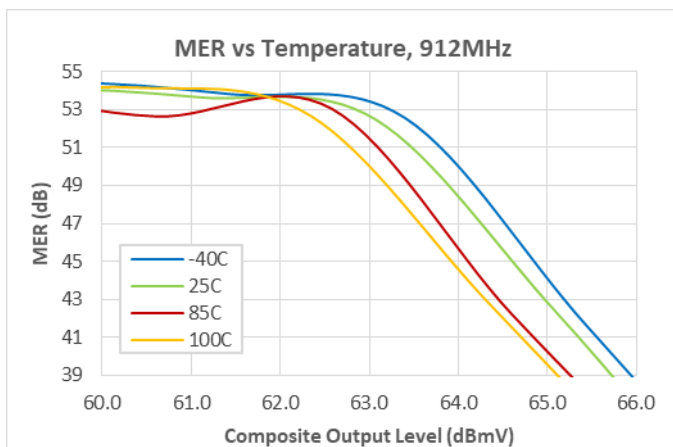
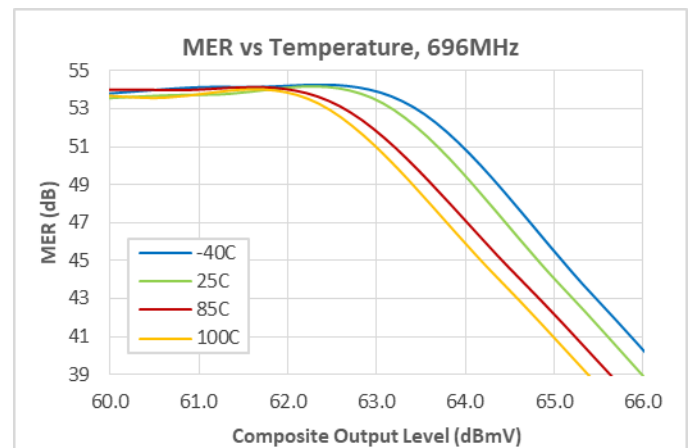
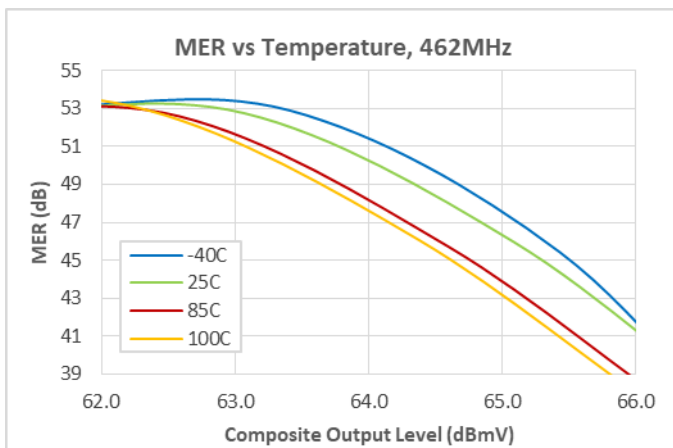
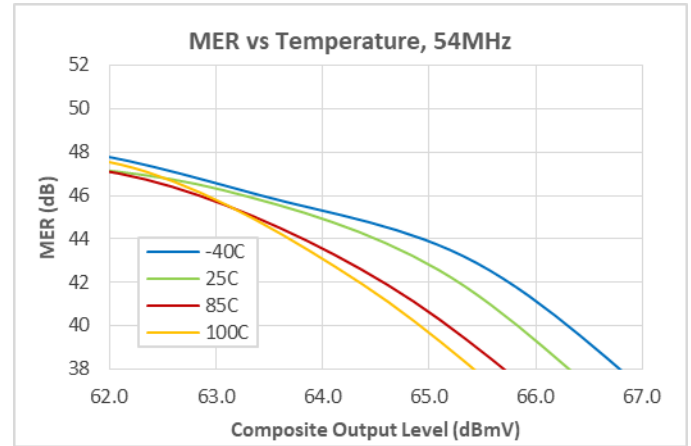
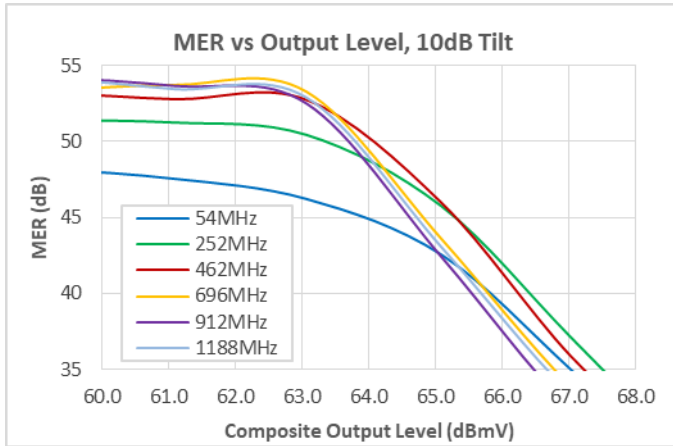

Notes:

1. Test conditions unless otherwise noted: VDD: 5V, Zo = 75Ω.
2. MER, Source Corrected, Maximum Correction 4.3dB, 54-1218MHz 256QAM, ITU-T J.83, Annex B

Performance Data; 50 – 1218 MHz, 8V

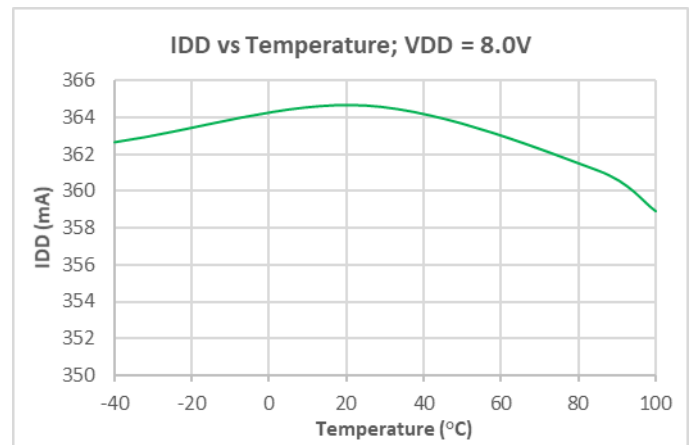
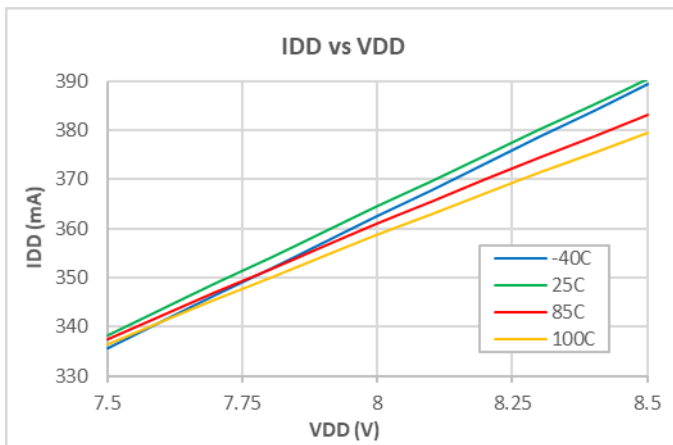
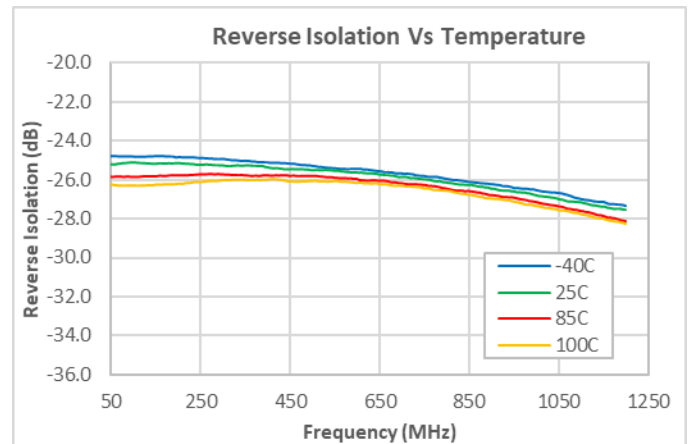
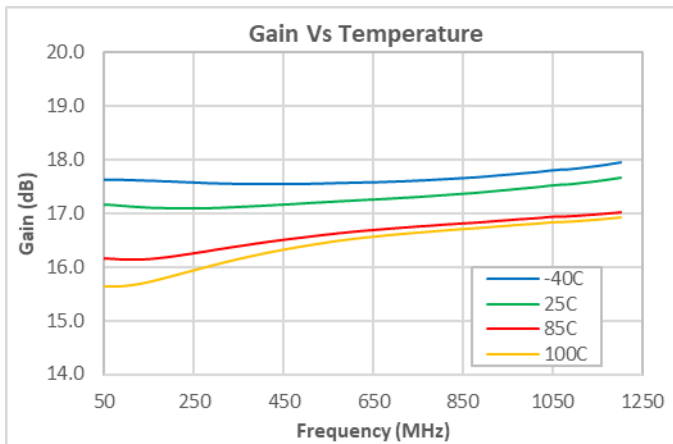
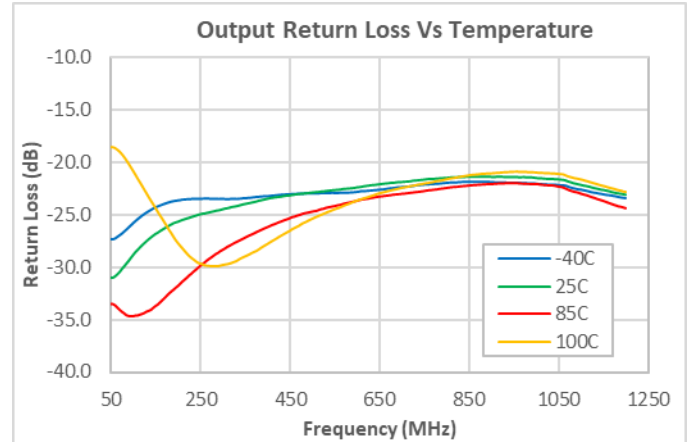
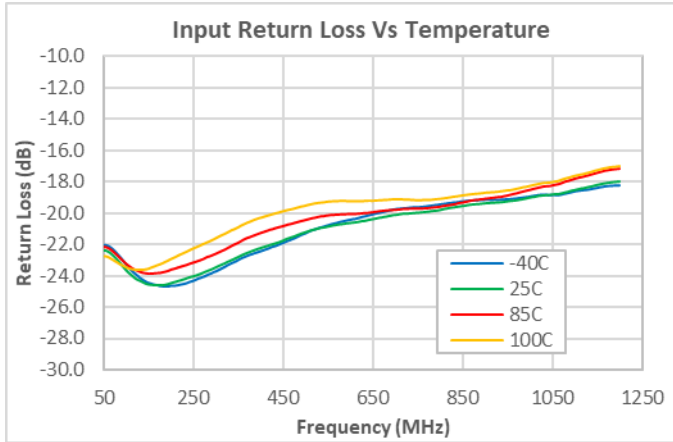

Notes:

1. Test conditions unless otherwise noted: VDD: 8V, Zo = 75Ω.

Performance Data; 50 – 1218 MHz, 8V

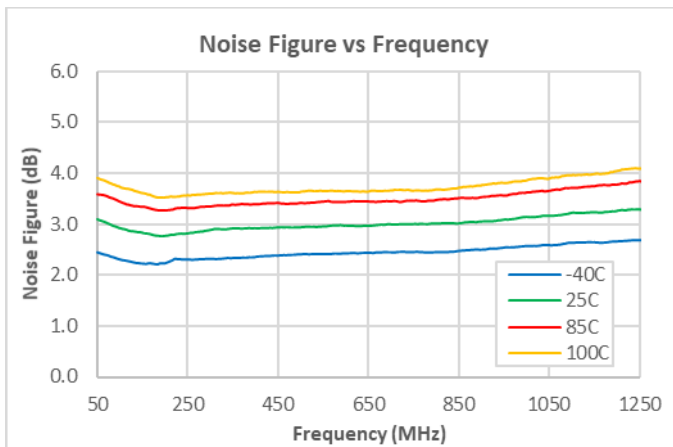
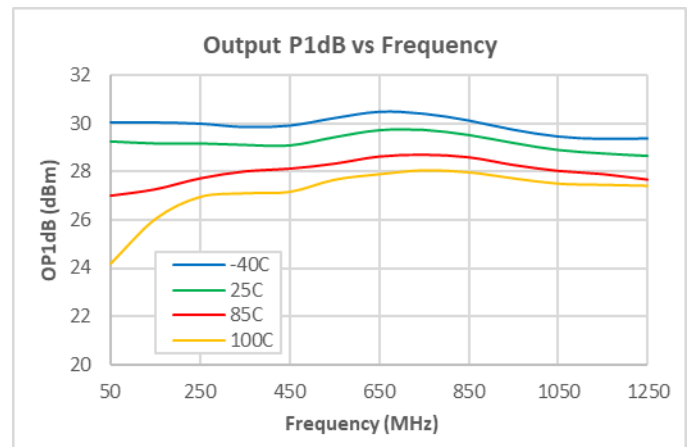
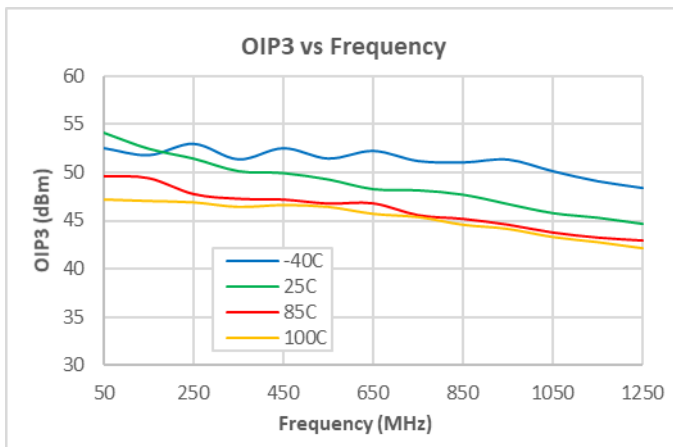
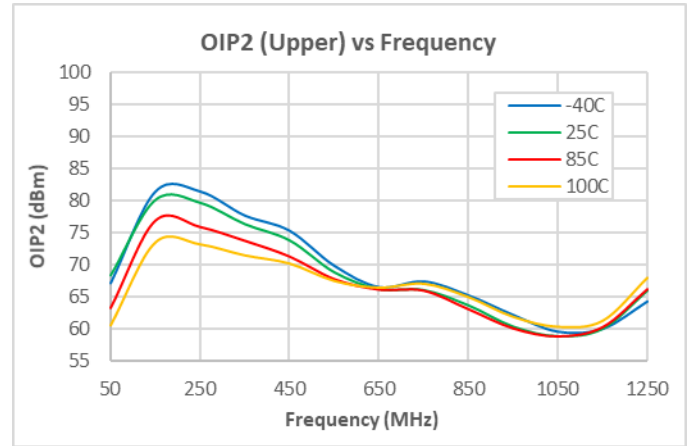
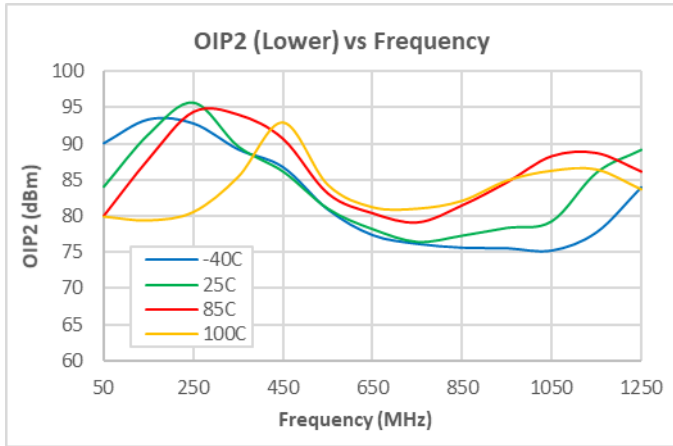

Notes:

1. Test conditions unless otherwise noted: VDD: 8V, Zo = 75Ω.
2. OIP2: 13 dBm / tone output, Δf = 50 MHz, 50-1218 MHz.
3. OIP3: 13 dBm / tone output, Δf = 6 MHz, 50-1218 MHz.
4. MER, Source Corrected, Maximum Correction 4.3dB, 54-1218MHz 256QAM, ITU-T J.83, Annex B.

Performance Data; 50 – 1218 MHz, 0dB Tilt, 8V

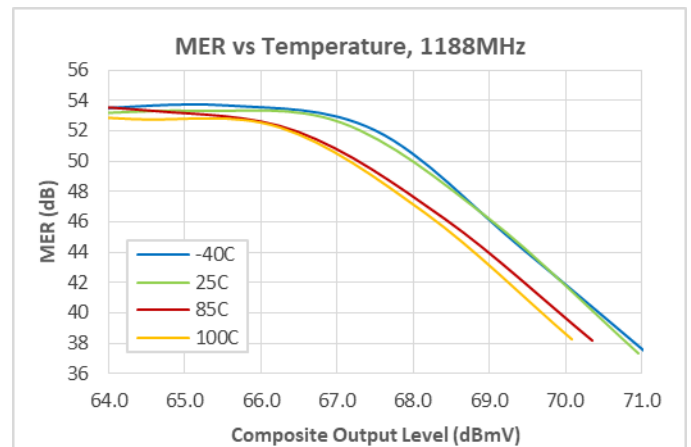
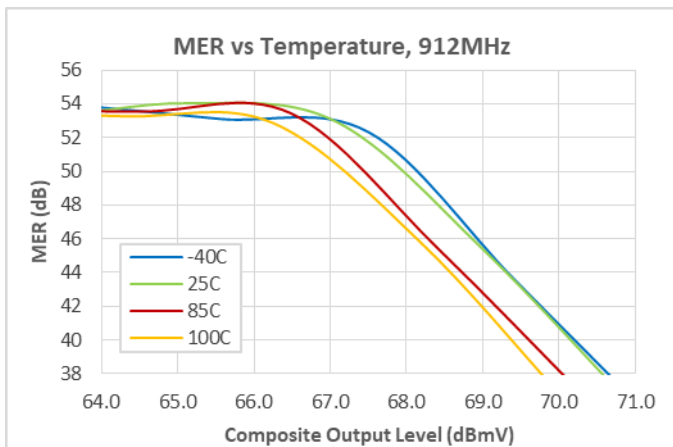
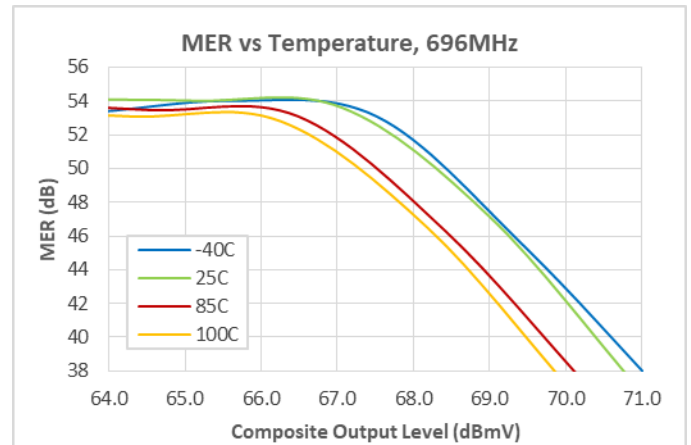
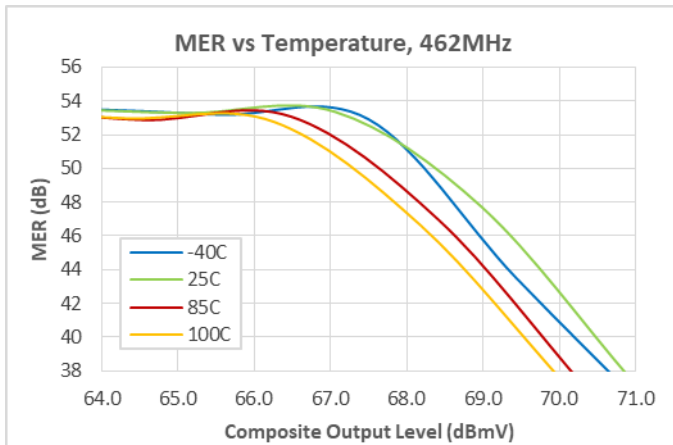
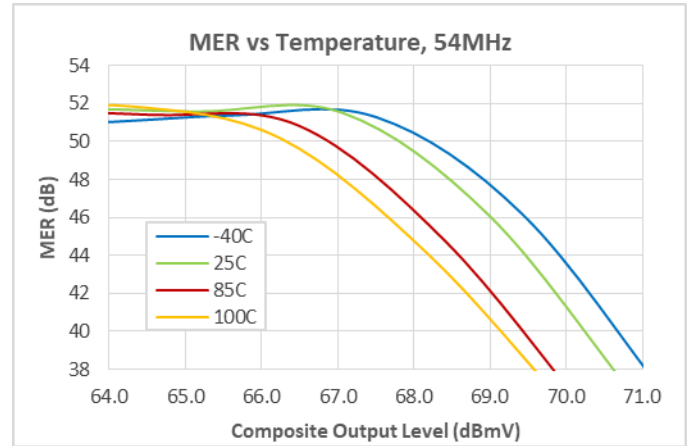
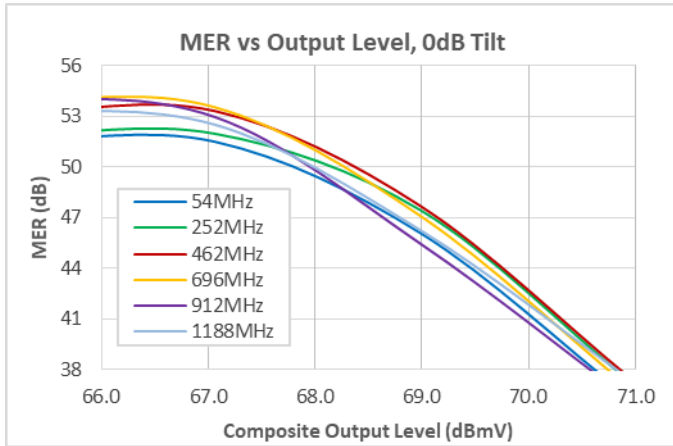

Notes:

1. Test conditions unless otherwise noted: VDD: 8V, $Z_o = 75\Omega$.
2. MER, Source Corrected, Maximum Correction 4.3dB, 54-1218MHz 256QAM, ITU-T J.83, Annex B.

Performance Data; 50 – 1218 MHz, 10dB Tilt, 8V

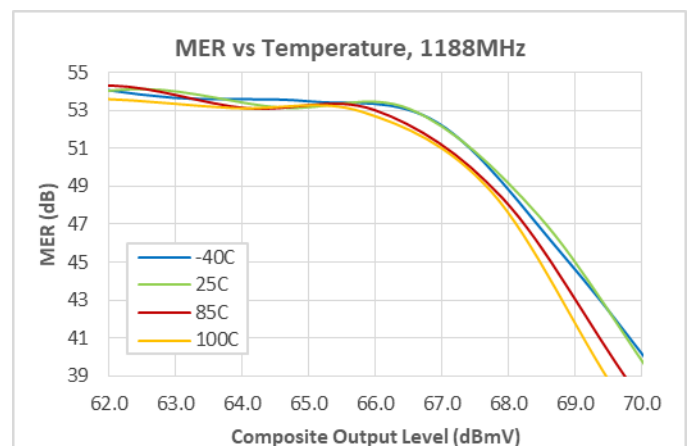
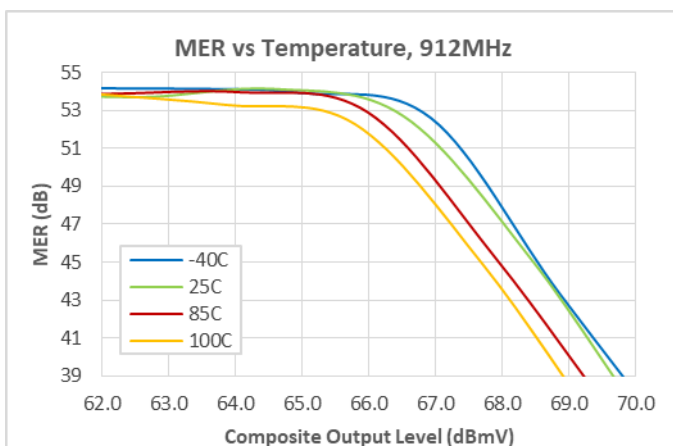
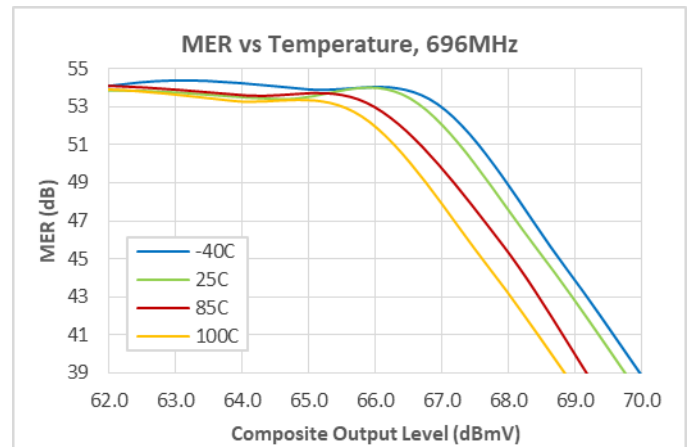
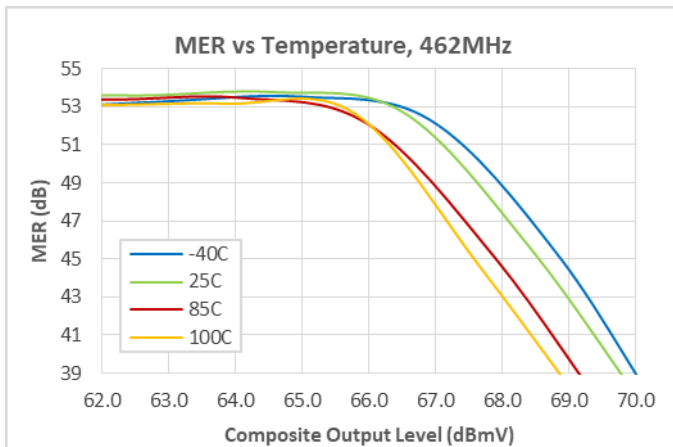
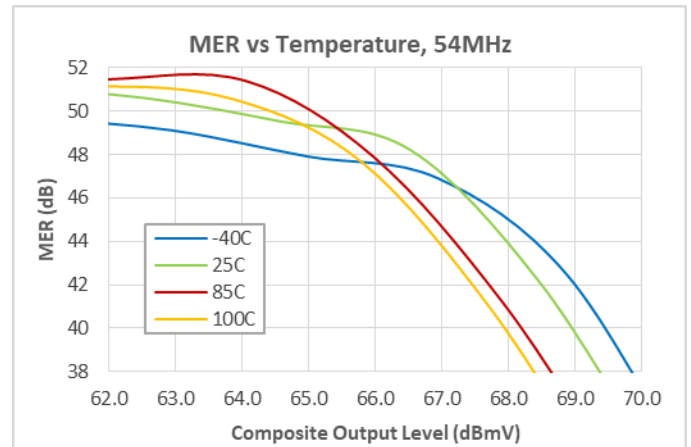
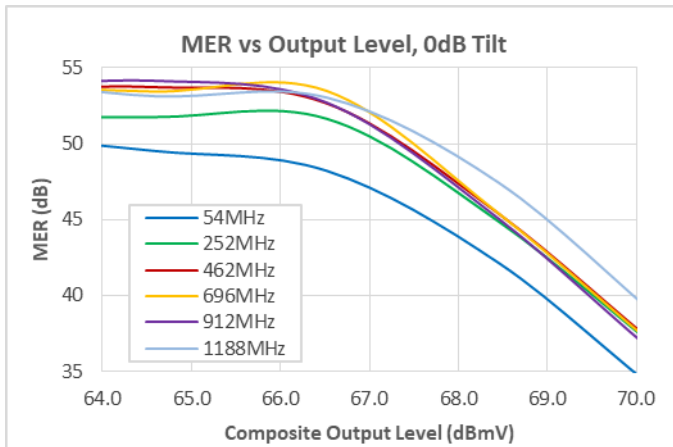

Notes:

1. Test conditions unless otherwise noted: VDD: 8V, Zo = 75Ω.
2. MER, Source Corrected, Maximum Correction 4.3dB, 54-1218MHz 256QAM, ITU-T J.83, Annex B.

Electrical Specifications; 5 – 684MHz, 5V

Parameter	Condition ⁽¹⁾	Min	Typ	Max	Unit
Supply Voltage (V _{DD})			5		V
Supply Current (I _{DD})			280		mA
Frequency Range		5		684	MHz
Gain			17		dB
Gain Flatness			±0.5		dB
Input Return Loss			20		dB
Output Return Loss			19		dB
Noise Figure			2.9		dB
OIP2L	+13 dBm / tone, Δf = 6 MHz		73		dBm
OIP2H	+13 dBm / tone, Δf = 6 MHz		68		dBm
OIP3	+13 dBm / tone, Δf = 6 MHz		49		dBm
Output P1dB			26		dBm
NPR	50dB Dynamic Range; 204MHz Bandwidth, 100MHz Notch		38.2		dB
MER	V _o = 65.8 dBmV Total Composite Output Power 5-204 MHz 33 Ch 256QAM, 0 dB Tilt, ITU-T J.83/B		45		dB
	V _o = 64.9 dBmV Total Composite Output Power 5-684 MHz 113 Ch 256QAM, 0 dB Tilt, ITU-T J.83/B				
Thermal Resistance	Bottom of Case		13		°C/W

Notes:

1. Typical performance at these conditions: Temp = +25 °C, V_{DD} = +5V, 75 Ω system, Full band unless otherwise noted.

Electrical Specifications; 5 – 684MHz, 8V

Parameter	Condition ⁽¹⁾	Min	Typ	Max	Unit
Supply Voltage (V _{DD})			8		V
Supply Current (I _{DD})			360		mA
Frequency Range		5		684	MHz
Gain			16.8		dB
Gain Flatness			±0.5		dB
Input Return Loss			20		dB
Output Return Loss			21		dB
Noise Figure			2.9		dB
OIPL	+13 dBm / tone, Δf = 6 MHz		80		dBm
OIP2H	+13 dBm / tone, Δf = 6 MHz		70		dBm
OIP3	+13 dBm / tone, Δf = 6 MHz, 5-700 MHz		48		dBm
Output P1dB			28		dBm
NPR	50dB Dynamic Range; 204MHz Bandwidth, 100MHz Notch		41.5		dB
MER	Vo = 69.1 dBmV Total Composite Output Power 5-204MHz 33 Ch 256QAM, 0 dB Tilt, ITU-T J.83/B		45		dB
	Vo = 68.7 dBmV Total Composite Output Power 5-684MHz 113 Ch 256QAM, 0 dB Tilt, ITU-T J.83/B				
Thermal Resistance	Bottom of Case		13		°C/W

Notes:

1. Typical performance at these conditions: Temp = +25 °C, V_{DD} = +5V, 75 Ω system, Full band unless otherwise noted.

Evaluation Board Schematic; 5 – 684 MHz, 5V

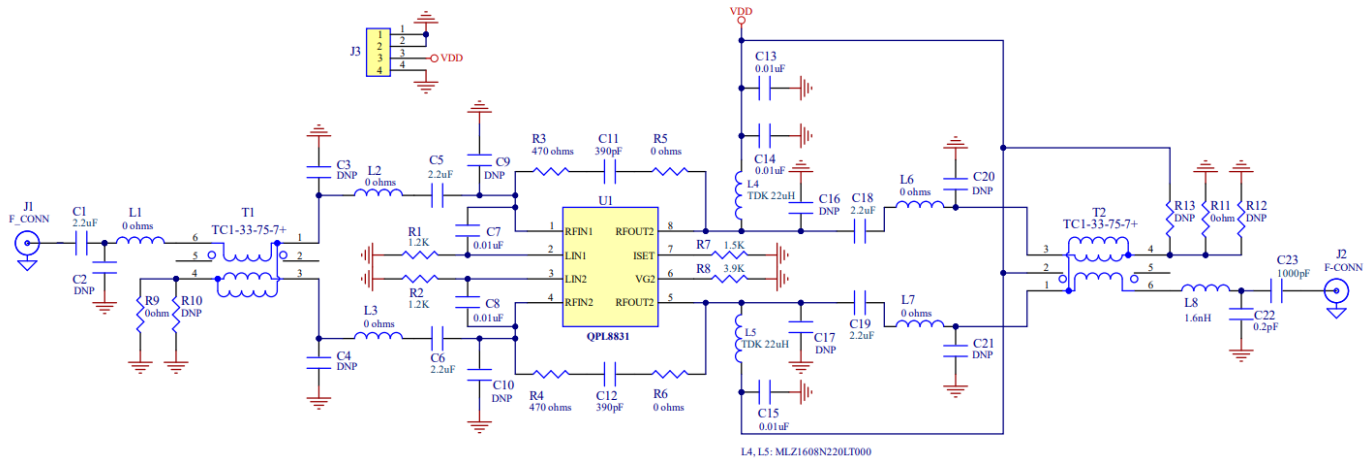

Bill of Material of Evaluation Board: 5 – 684 MHz, 5V

Reference Designator	Description	Manufacturer	Part Number
U1	5 - 1218 MHz, 21 dB Push-Pull Amp	Qorvo	QPL8831SB
PCB	EVB PCB, QPL8831	Qorvo	QPL883x-4001
C23	CAP, 1000pF, 5%, 50V, C0G, 0402	Murata	GRM1555C1H102JA01D
C1, C5, C6, C18, C19	CAP, 2.2uF, 10%, 16V, X5R, 0402	Murata	GRM155R61C225KE11D
C22	CAP, 0.2pF, +/-0.1pF, 50V, HI-Q, 0402	Murata	GJM1555C1HR20BB01D
C7, C8, C13, C14, C15	CAP, 0.01uF, 10%, 50V, X7R, 0402	Murata	GCM155R71H103KA55D
C11, C12	CAP, 390pF, 2%, 50V, C0G, 0402	Murata	GCM1555C1H391GA16D
L1, L2, L3, L6, L7, R5, R6, R9, R11	RES, 0 OHM, 1/10W, 0402	Kamaya	RMC1/16SJPTH
R7	RES, 1.5K, 5%, 1/16W, 0402	Kamaya	RMC1/16S-152JTH
R8	RES, 3.9K, 5%, 1/16W, 0402	Kamaya	RMC1/16S-392JTH
R1, R2	RES, 1.2K, 5%, 1/16W, 0402	Kamaya	RMC1/16S-122JTH
R3, R4	RES, 470 OHM, 5%, 1/16W, 0402	Kamaya	RMC1/16S-471JTH
L4, L5	IND, 22uH, 20%, 190mA, M/L, 0603	TDK	MLZ1608N220LT000
L8	IND, 1.6nH, ±0.1nH, 1000mA, M/L, 0402	Murata	LQG15HS1N6B02D
T1, T2	TRANSFORMER, 1:1	Mini Circuits	TC1-33-75-7+
J3	CONN, HDR	Samtec	TSW-104-08-S-S
J1, J2	CONN, F FEM, 75OHM	MM Wave	MW-846-C-DD-75
HS	HEATSINK BLOCK, 1.5 X 2.0 IN	Shenzhen Minxingda	EEF-105441
S1-S4	SCREW, 2-56X3/16"	McMaster-Carr	92196A076
C2, C3, C4, C9, C10, C16, C17, C20, C21, R10, R12, R13	DNP		

8V BOM Changes:

Reference Designator	Description	Manufacturer	Part Number
R1, R2	RES, 2K, 5%, 1/16W, 0402	Kamaya	RMC1/16S-202JTH
R7	RES, 768 OHM, 1%, 1/16W, 0402	Vishay	CRCW0402768RFKED

Typical Application Schematic; 5 – 684 MHz, 5V

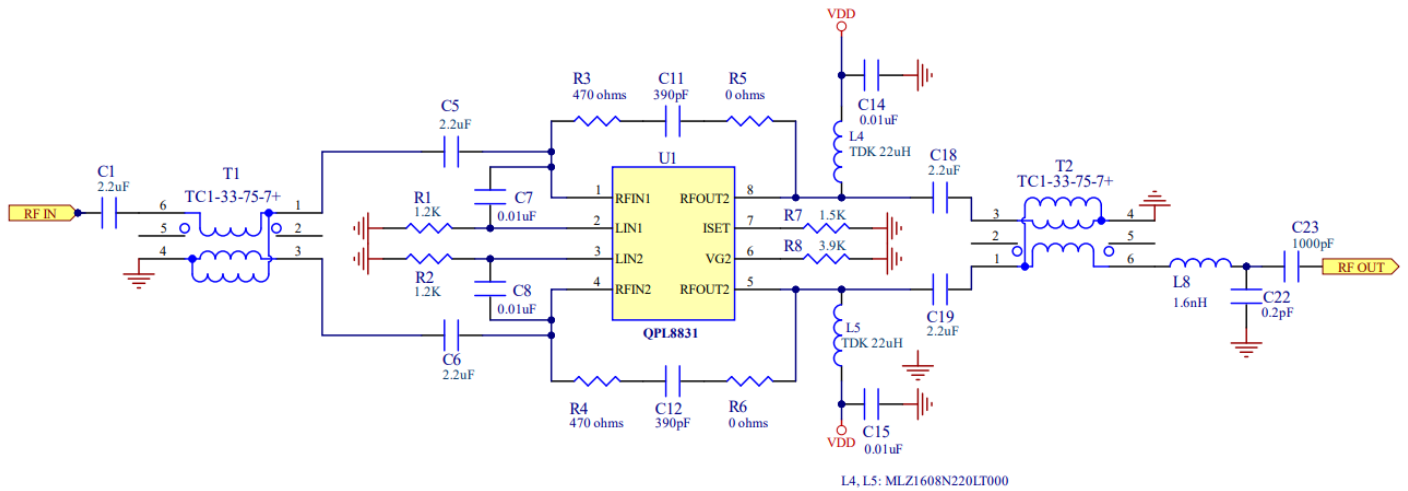

L4, L5: MLZ1608N220LT000

R3, R5 and R4, R6 form the feedback along with the DC blocking caps, C11 and C12. C11, C12 are tuned to improve 5MHz flatness. Increasing resistance increases gain and while decreasing resistance will reduce gain. Changes to the feedback resistance will impact return loss and may require retuning the match. L4, L5 are bias chokes for RF decoupling to the power supply. Other inductors may be used that provide greater than 5.6uH of effective inductance at 5MHz with low DC resistance. C2 and L1 (DNP) tune the input match. L8, C22, C23 are used for output matching. T1 and T2 are 1:1 tertiary baluns suitable for downstream or upstream use. R1, R2, C7 and C8 form the Linearizer bias circuit and are described in more detail on pg 25. R7 sets the device current, while R8 sets the gate voltage of the output stage (refer to pg 25 for further details). 2.2uF blocking capacitors minimize impedance at 5MHz. Lower values may be employed as long as sufficient performance in the application is maintained.

Performance Data; 5 – 684 MHz, 5V

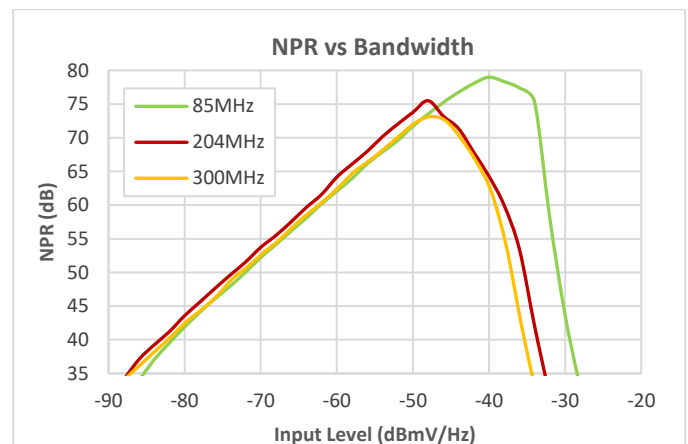
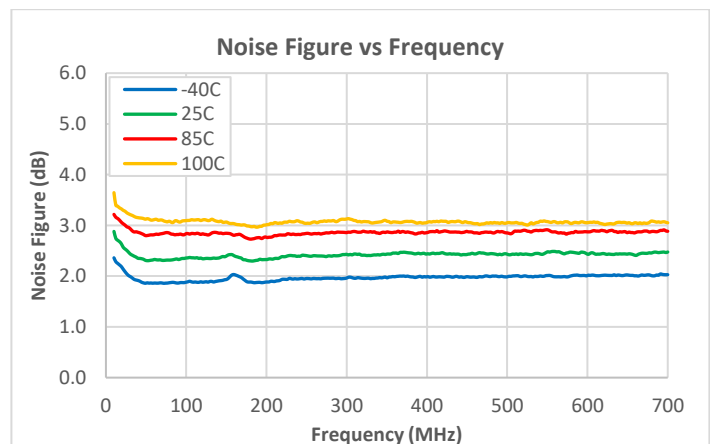
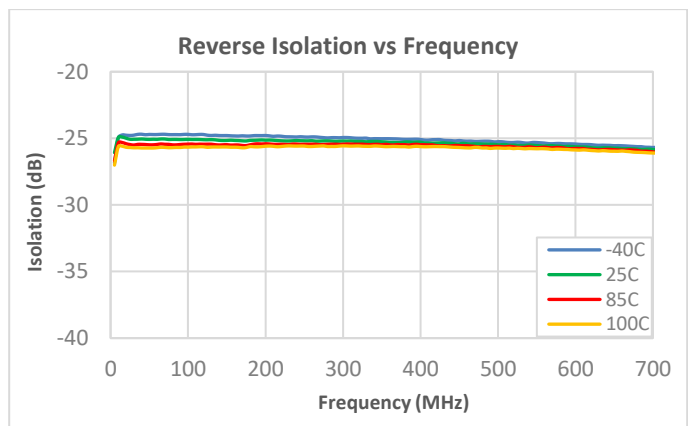
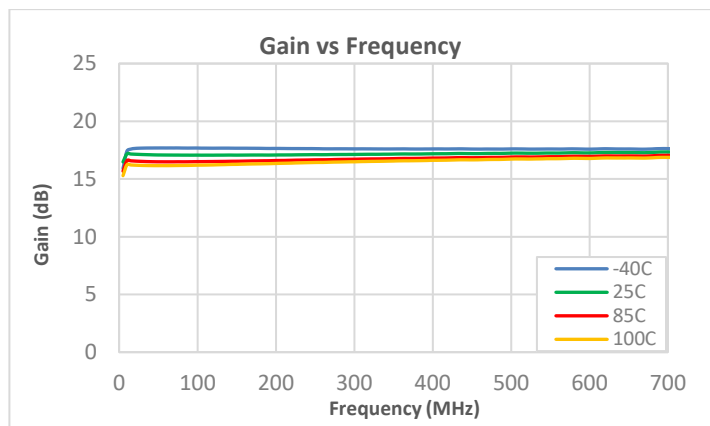
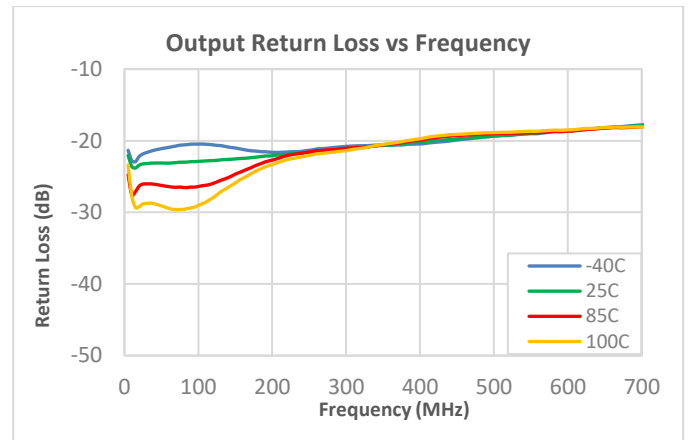
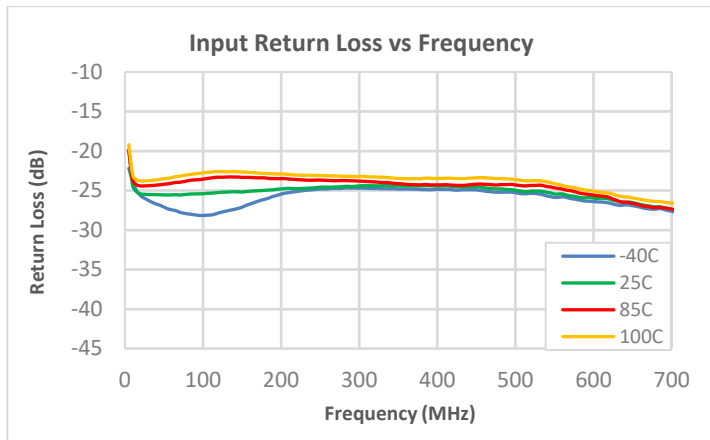

Notes:

1. Test conditions unless otherwise noted: VDD: 5V, Zo = 75Ω.
2. NPR:
 - a. 42MHz Bandwidth, 21.4MHz Notch
 - b. 85MHz Bandwidth, 41MHz Notch
 - c. 204MHz Bandwidth, 100MHz Notch
 - d. 300MHz Bandwidth, 150MHz Notch

Performance Data; 5 – 684 MHz, 5V

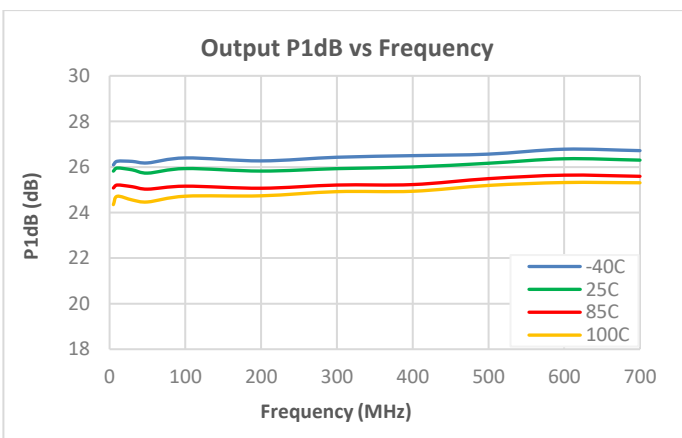
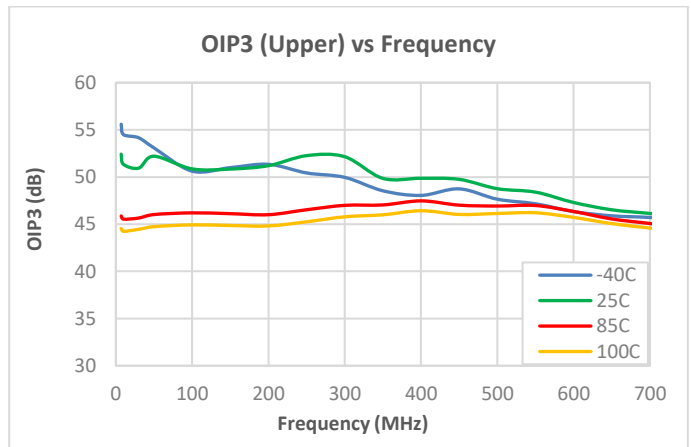
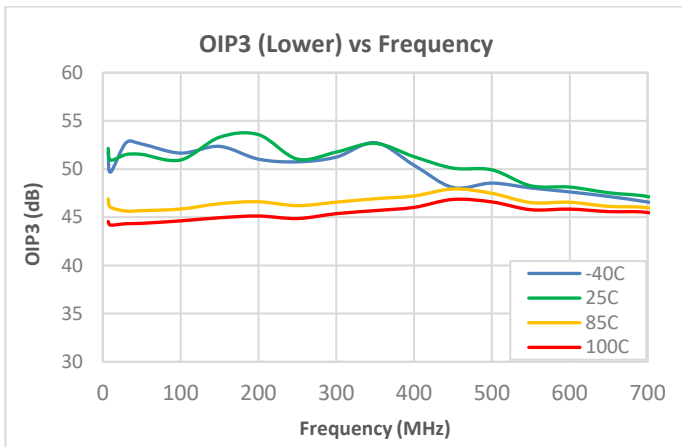
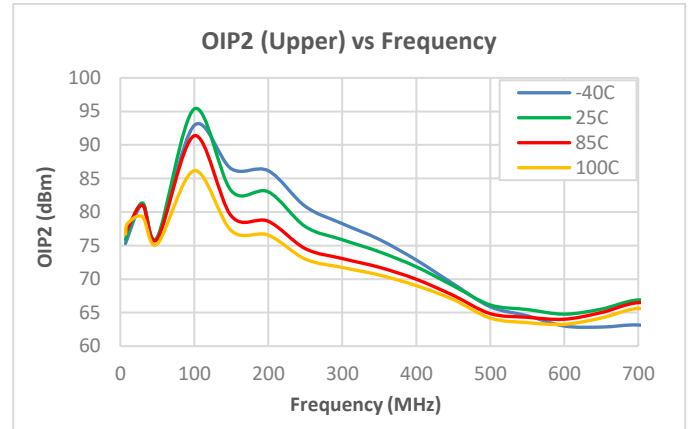
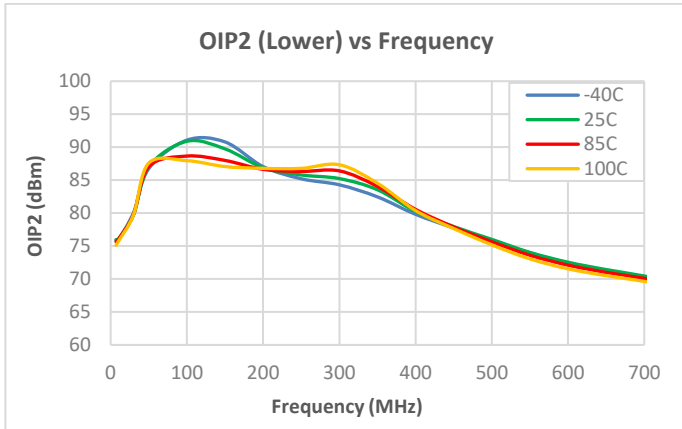

Notes:

1. Test conditions unless otherwise noted: VDD: 5V, $Z_o = 75\Omega$.
2. OIP2: 13 dBm / tone output, $\Delta f = 6$ MHz, 5-700 MHz.
3. OIP3: 13 dBm / tone output, $\Delta f = 6$ MHz, 5-700 MHz.

Performance Data; 5 – 684 MHz, 5V

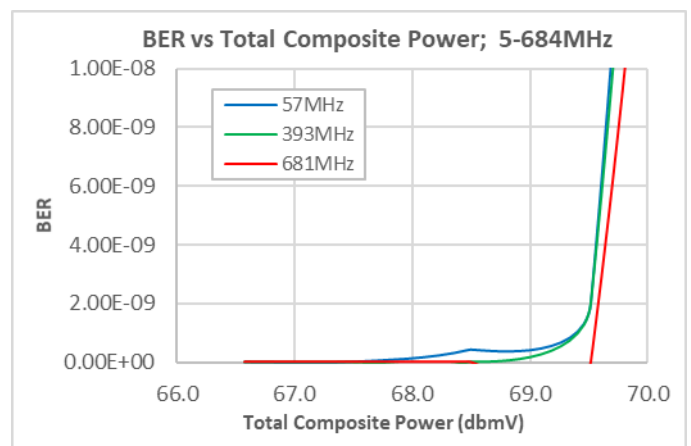
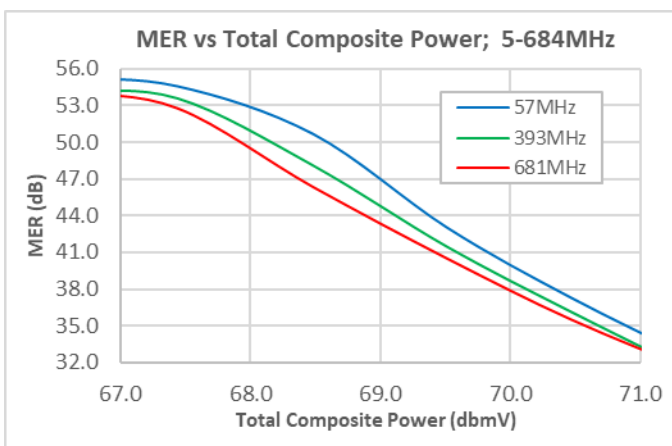
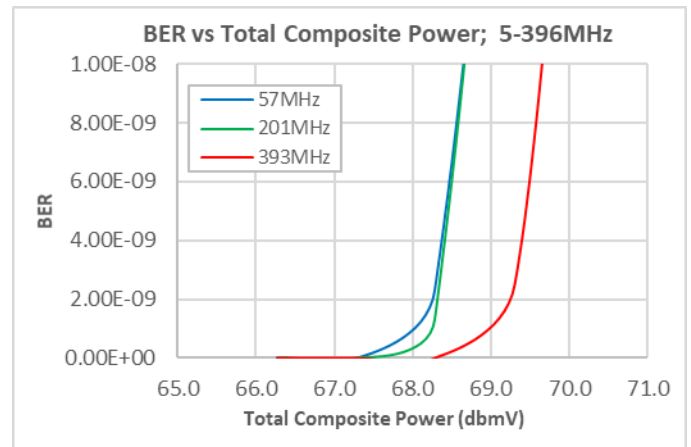
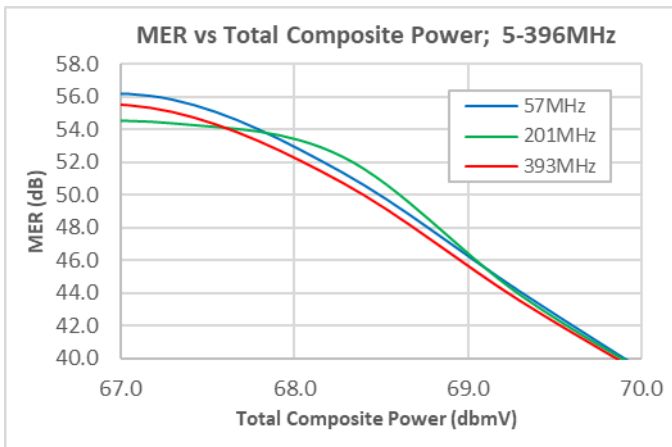
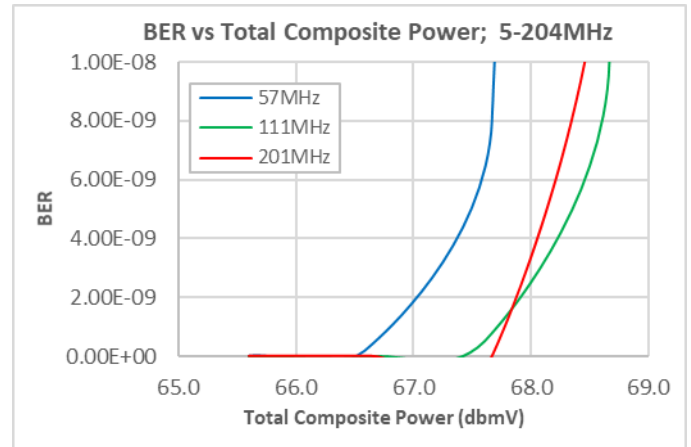
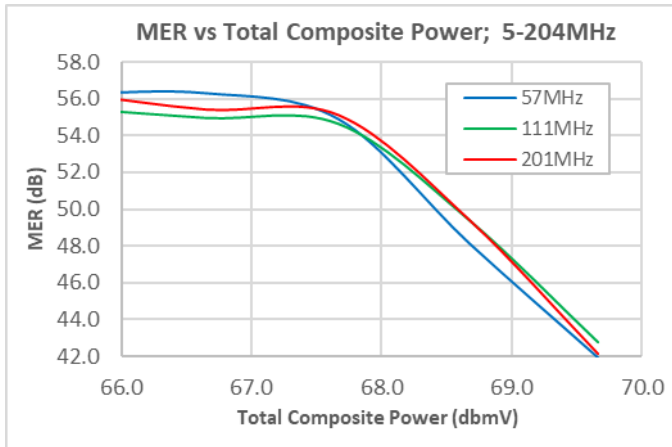

Notes:

1. Test conditions unless otherwise noted: VDD: 5V, $Z_o = 75\Omega$.
2. MER, Source Corrected, Maximum Correction 4.3dB, 256 QAM, ITU-T J.83, Annex B

Performance Data; 5 – 684 MHz, 8V

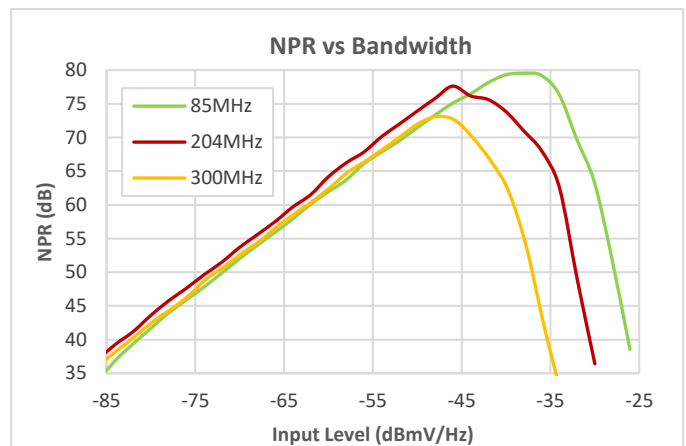
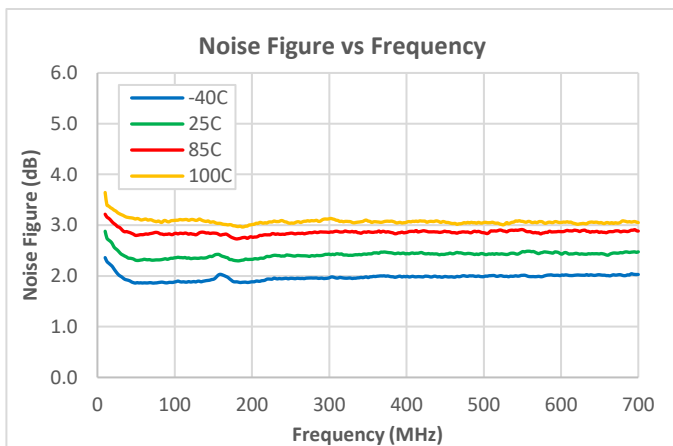
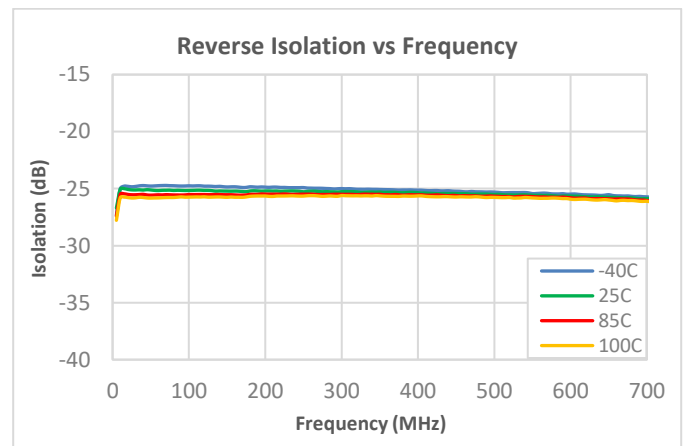
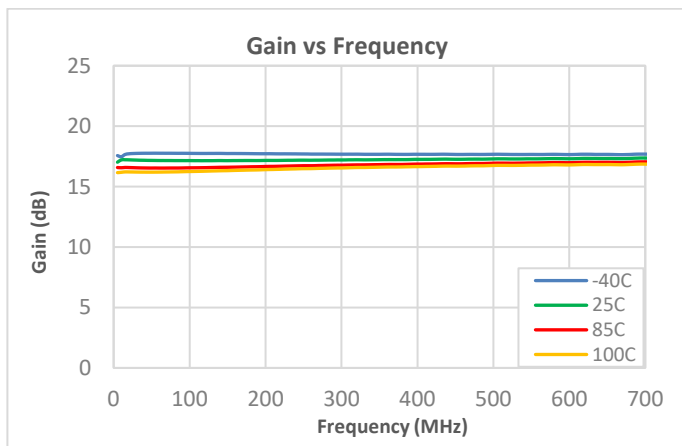
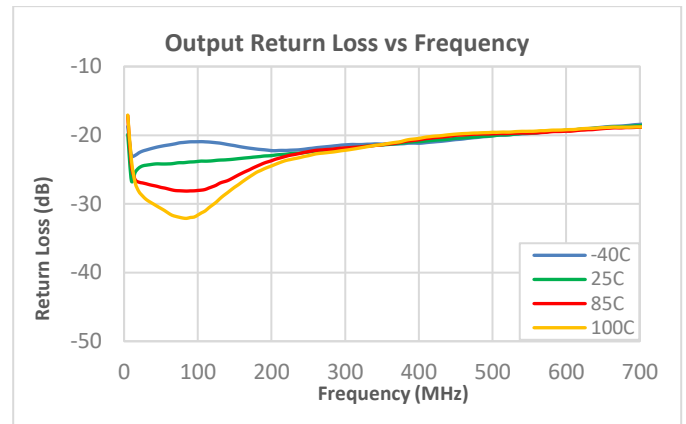
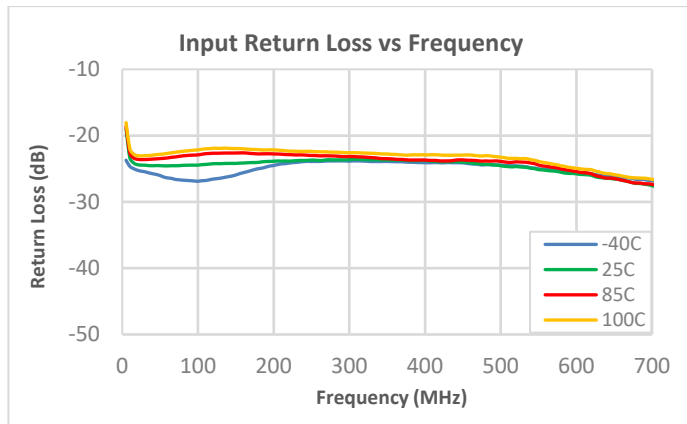

Notes:

1. Test conditions unless otherwise noted: VDD: 8V, Zo = 75Ω.
2. NPR:
 - a. 42MHz Bandwidth, 21.4MHz Notch
 - b. 85MHz Bandwidth, 41MHz Notch
 - c. 204MHz Bandwidth, 100MHz Notch
 - d. 300MHz Bandwidth, 150MHz Notch

Performance Data; 5 – 684 MHz, 8V

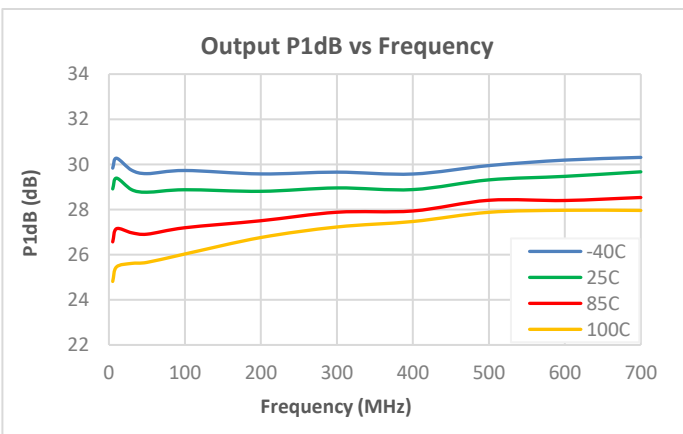
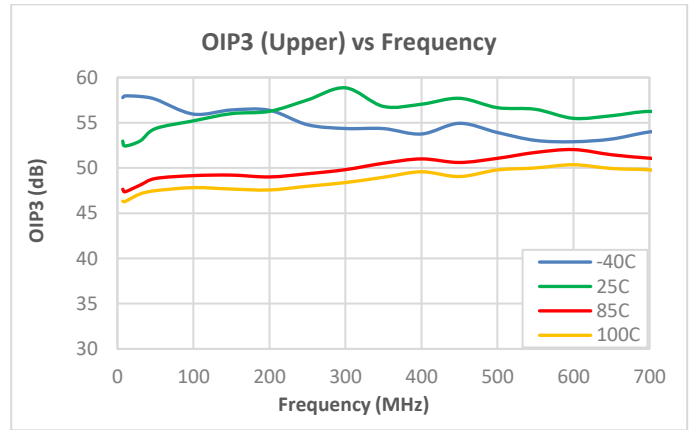
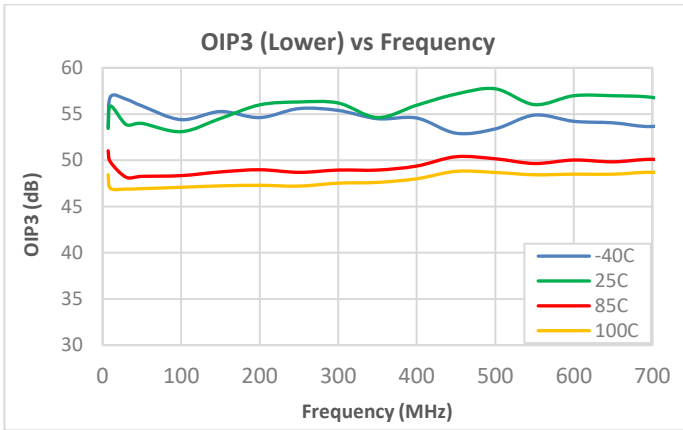
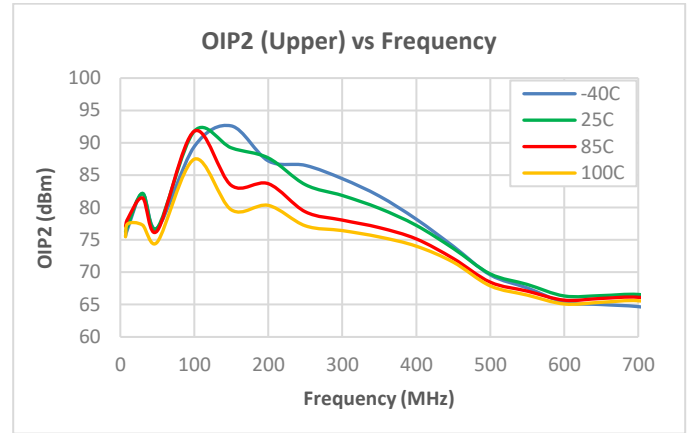
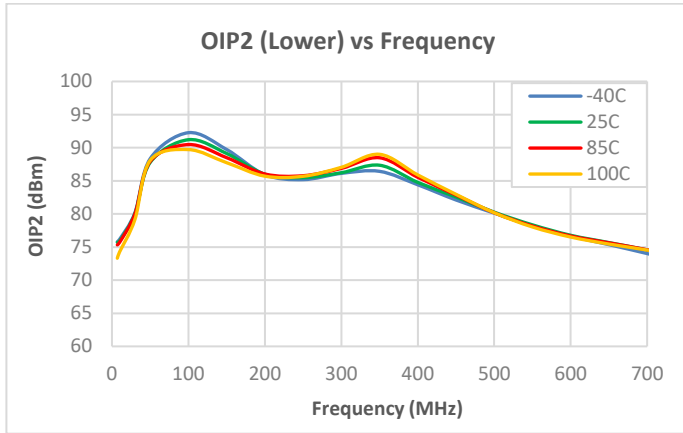

Notes:

1. Test conditions unless otherwise noted: VDD: 8V, Zo = 75Ω.
2. OIP2: 13 dBm / tone output, Δf = 6 MHz, 5-700 MHz.
3. OIP3: 13 dBm / tone output, Δf = 6 MHz, 5-700 MHz.

Performance Data; 5 – 684 MHz, 8V

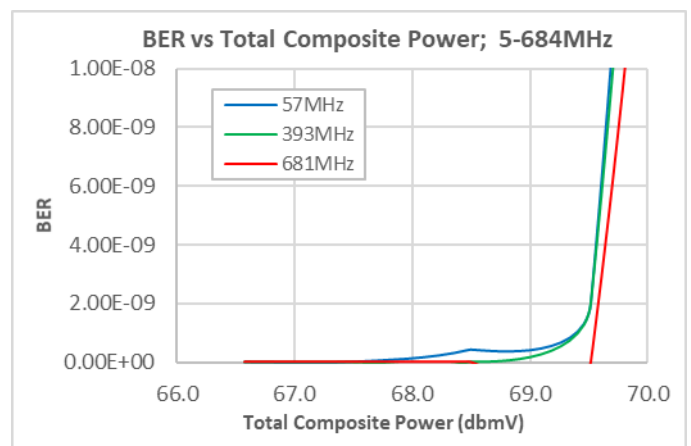
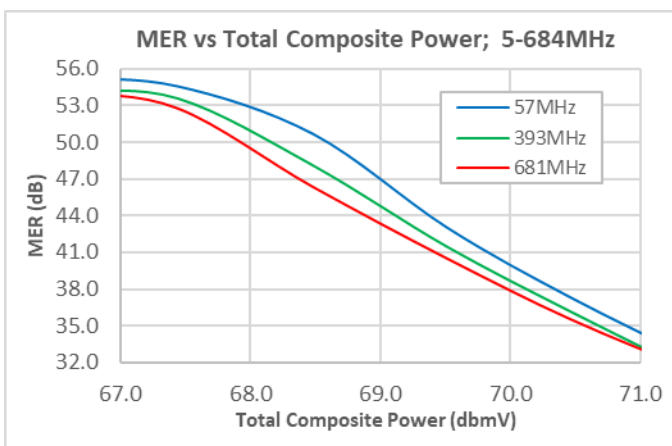
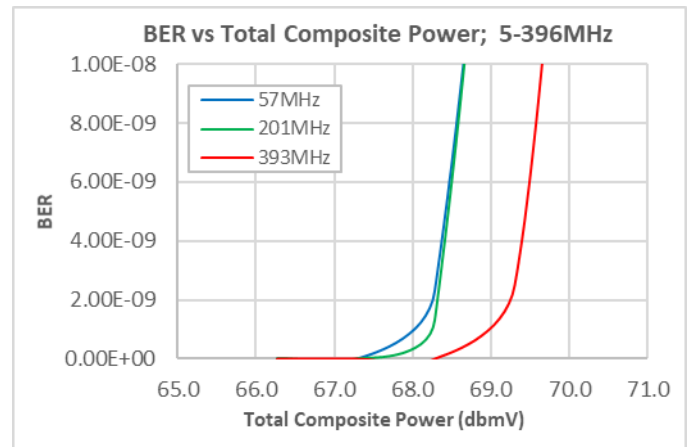
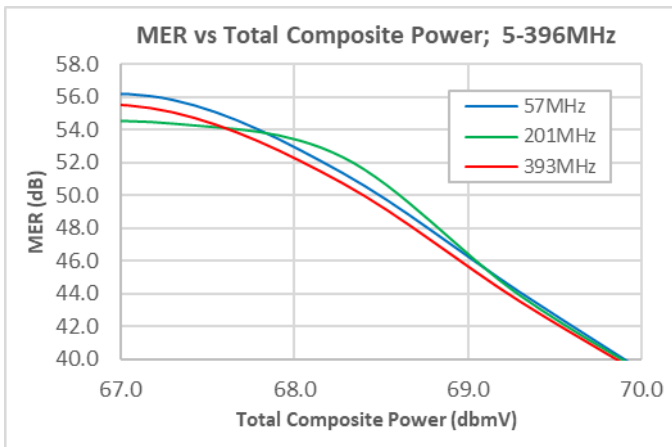
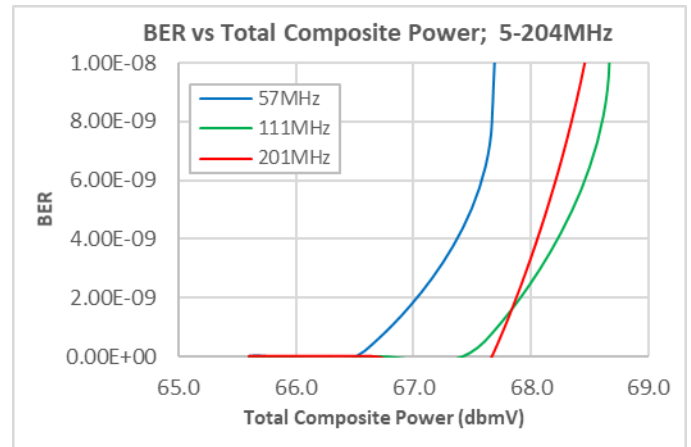
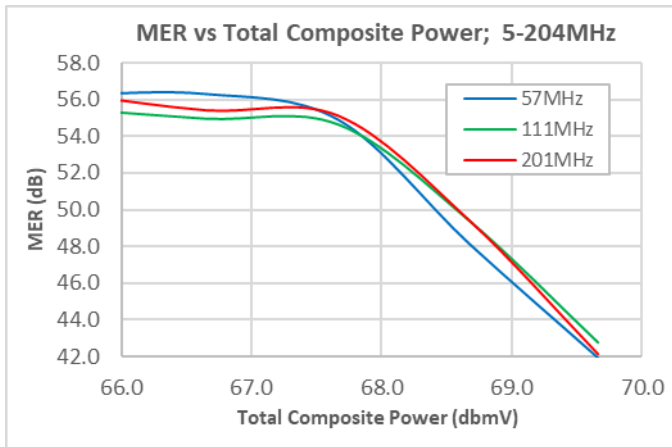

Notes:

1. Test conditions unless otherwise noted: VDD: 8V, Zo = 75Ω.
2. MER, Source Corrected, Maximum Correction 4.3dB, 256 QAM, ITU-T J.83, Annex B

Linearizer Current Settings

The linearizer is a fixed pre-distortion circuit that can correct for 3rd order non-linearity. The amount of pre-distortion correction is set by the linearizer bias current, ILIN. The linearizer circuit is coupled to the RF path through C7 and C8. Disconnecting C7 and C8 will disable the linearizer which causes the gain to increase slightly (~0.5dB) but will also degrade S11 and OIP3.

In the application circuit, R1 and R2 are used to set ILIN to a value optimized for the desired operating conditions. ILIN can be calculated using the equation below.

$$ILIN = 2 \cdot (V_{dd} - 1.6V) / (R1 + 1125)$$

The value of ILIN has been optimized for QPL8831 for 5V, 280mA. In applications with alternate values of VDD or IDD, ILIN can be reoptimized to improve linearity by checking for best MER at several frequencies across the desired operating conditions (flat, tilt, etc).

The graph on the right-hand side shows the change in ILIN vs. R1, R2 for 5V VDD.

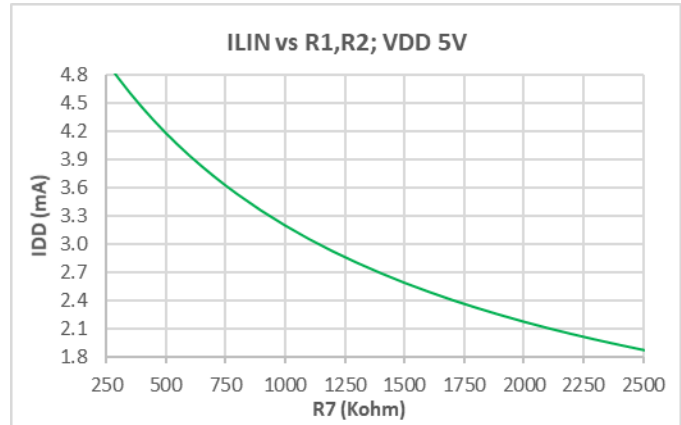

ISET Resistor Value

R7 is used to set the device current. In the QPL8831 application circuit, the value of R7 is set for an IDD of 280mA for 5V and 360mA for 8V to optimize MER. In applications where reduced linearity is acceptable, IDD can be reduced lowering the value of R7 (see graphs below).

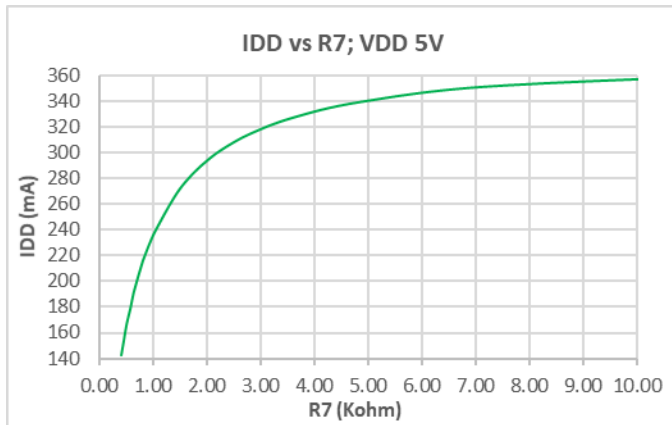

VG2 Resistor Value Settings

VG2 (pin 6) is connected to the gate of the output device. Resistor R8 is used to fine tune VG2 for best linearity. It is not normally necessary or recommended to tune VG2.

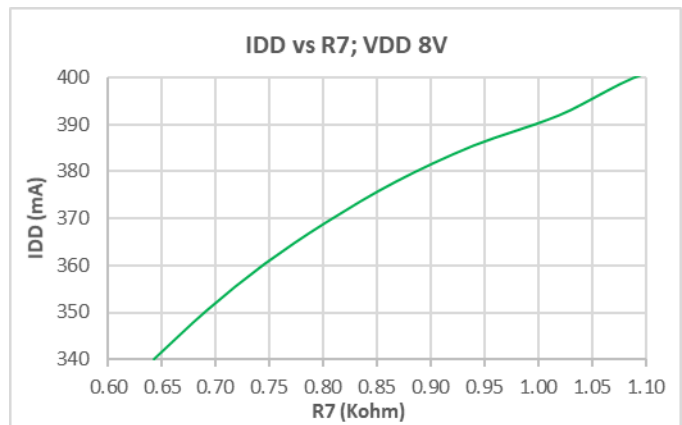

Package Marking

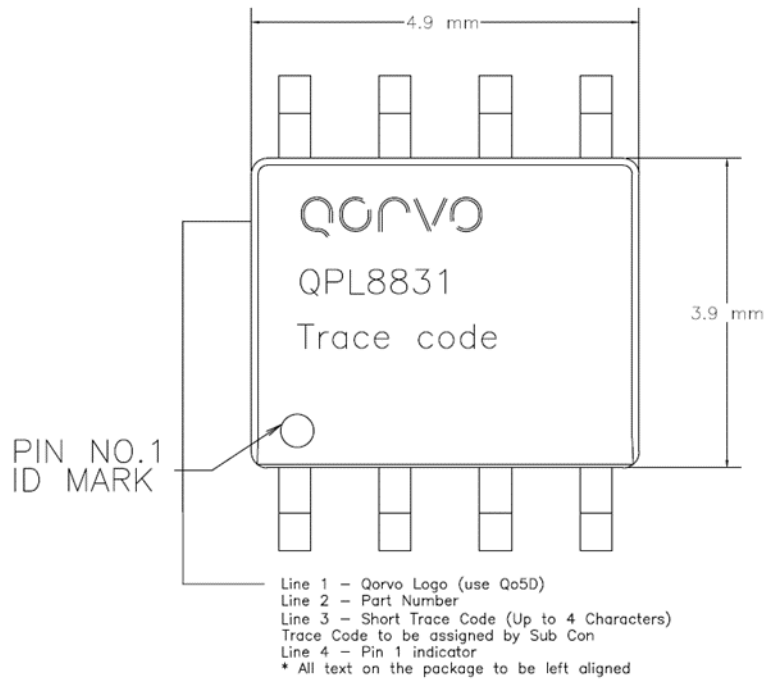

Package Outline

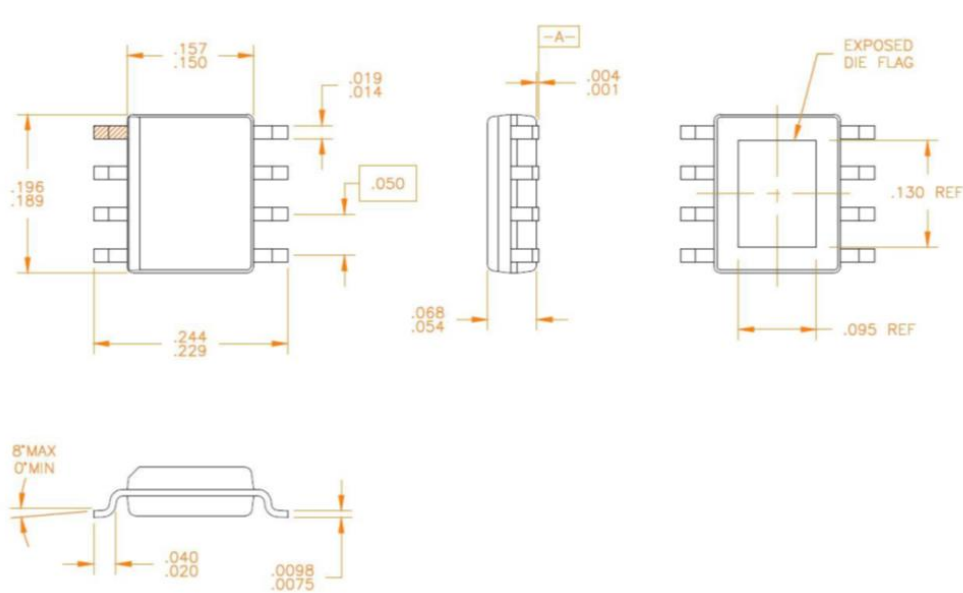

1. All dimensions are in inches. Angles are in degrees.

Notes:

1. All Dimensions are in inches.
2. Angles are in degrees.

Notes: All dimensions are in millimeters. Angles are in degrees.

Recommended Mounting Pattern

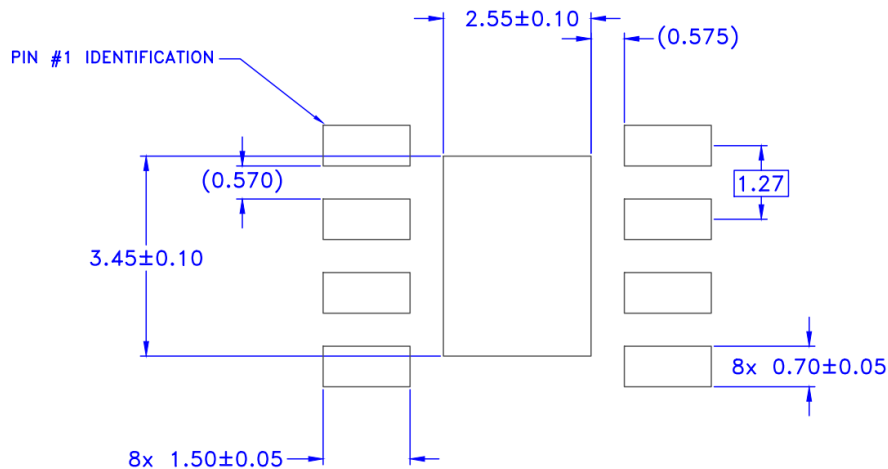

1. Use 1 oz. copper minimum for top and bottom layer metal.
2. Vias are required under the backside paddle for proper RF/DC grounding and thermal dissipation.
3. Recommend a 0.35 mm diameter bit for drilling via holes and a final plated thru diameter of 0.25 mm (10mils).

Handling Precautions

Parameter	Rating	Standard
ESD – Human Body Model (HBM)	Class 1B (500V to <1000V)	ESDA/JEDEC JS-001
ESD – Charged Device Model (CDM)	Class C3 (≥1000V)	ESDA/JEDEC JS-002
MSL – Moisture Sensitivity Level	Level 3	IPC/JEDEC J-STD-020



Caution!
ESD-Sensitive
Device

Solderability

Compatible with both lead-free (260 °C max. reflow temp.) and tin/lead (245 °C max. reflow temp.) soldering processes. Solder profiles available upon request.

Contact plating: NiPdAu

RoHS Compliance

This part is compliant with 2011/65/EU RoHS directive (Restrictions on the Use of Certain Hazardous Substances in Electrical and Electronic Equipment) as amended by Directive 2015/863/EU.

This product also has the following attributes:

- Lead Free
- Halogen Free (Chlorine, Bromine)
- Antimony Free
- TBBP-A (C₁₅H₁₂Br₄O₂) Free
- PFOS Free
- SVHC Free



Contact Information

For the latest specifications, additional product information, worldwide sales and distribution locations:

Tel: 1-844-890-8163

Web: www.qorvo.com

Email: customer.support@qorvo.com

Important Notice

The information contained in this Data Sheet and any associated documents (“Data Sheet Information”) is believed to be reliable; however, Qorvo makes no warranties regarding the Data Sheet Information and assumes no responsibility or liability whatsoever for the use of said information. All Data Sheet Information is subject to change without notice. Customers should obtain and verify the latest relevant Data Sheet Information before placing orders for Qorvo® products. Data Sheet Information or the use thereof does not grant, explicitly, implicitly or otherwise any rights or licenses to any third party with respect to patents or any other intellectual property whether with regard to such Data Sheet Information itself or anything described by such information.

DATA SHEET INFORMATION DOES NOT CONSTITUTE A WARRANTY WITH RESPECT TO THE PRODUCTS DESCRIBED HEREIN, AND QORVO HEREBY DISCLAIMS ANY AND ALL WARRANTIES WITH RESPECT TO SUCH PRODUCTS WHETHER EXPRESS OR IMPLIED BY LAW, COURSE OF DEALING, COURSE OF PERFORMANCE, USAGE OF TRADE OR OTHERWISE, INCLUDING THE IMPLIED WARRANTIES OF MERCHANTABILITY AND FITNESS FOR A PARTICULAR PURPOSE. Without limiting the generality of the foregoing, Qorvo® products are not warranted or authorized for use as critical components in medical, life-saving, or life-sustaining applications, or other applications where a failure would reasonably be expected to cause severe personal injury or death. Applications described in the Data Sheet Information are for illustrative purposes only. Customers are responsible for validating that a particular product described in the Data Sheet Information is suitable for use in a particular application.

© 2023 Qorvo US, Inc. All rights reserved. This document is subject to copyright laws in various jurisdictions worldwide and may not be reproduced or distributed, in whole or in part, without the express written consent of Qorvo US, Inc. | QORVO® is a registered trademark of Qorvo US, Inc.

Looking for pricing, stock, or lifecycle information?

Click below to explore more details on WIN SOURCE:

 [View QPL8831TR13 on WIN SOURCE](#)

 [Qorvo US Inc. Information](#)

Optimize Your Supply Chain with WIN SOURCE Solutions

-  Global Sourcing Solution
-  Obsolete Management
-  Cost Control Management
-  Shortage Management
-  Alternative Solution
-  Excess Inventory Management