

Wide Band Low Noise Amplifier with Auto Gain Control Function

FEATURES

- High gain 18 dB typ. @ 40 to 780 MHz
- Low noise figure 0.9 dB typ. @ 174 to 780 MHz
- Auto gain control (AGC) function with hysteresis
- Integrated signal detector with thermal compensation
- Package size 3.4 x 2.6 mm², 26-pin
- RoHS compliant and Halogen Free, MSL1

APPLICATION

- Digital TV, DAB, FM, terrestrial broadcast applications
- Active antenna, digital video recorder, set top box, tuner module applications

BLOCK DIAGRAM (EQFN26-HH) (Top view)

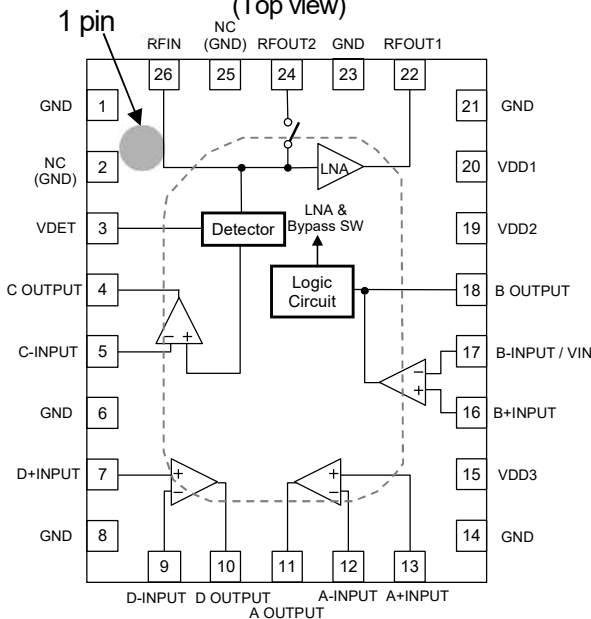

GENERAL DESCRIPTION

The NJG1740MHH is a wideband low noise amplifier with AGC function for DAB, DTV and FM applications.

This LNA has LNA mode and bypass mode switched by AGC function which features temperature compensation and hysteresis performance to avoid excessively frequent switching (chattering). AGC function is suitable for active antennas whose gain can't be controlled externally.

Its integrated ESD protection circuits bring high ESD tolerance.

The small and thin EQFN26-HH package is adopted.

PIN CONFIGURATION

PIN NO.	SYMBOL	DESCRIPTION
1	GND	Ground
2	NC(GND)	No Connection
3	VDET	Detector signal output
4	C OUTPUT	Output C
5	C -INPUT	Inverting input C
6	GND	Ground
7	D +INPUT	Noninverting input D
8	GND	Ground
9	D -INPUT	Inverting input D
10	D OUTPUT	Output D
11	A OUTPUT	Output A
12	A -INPUT	Inverting input A
13	A +INPUT	Noninverting input A
14	GND	Ground
15	VDD3	Power supply 3
16	B +INPUT	Noninverting input B
17	B -INPUT / VIN	Inverting input B / Manual inspection
18	B OUTPUT	Output B
19	VDD2	Power supply 2
20	VDD1	Power supply 1
21	GND	Ground
22	RFOUT1	RF output 1 (LNA mode)
23	GND	Ground
24	RFOUT2	RF output 2 (bypass mode)
25	NC(GND)	No Connection
26	RFIN	RF input
Exposed pad	GND	Ground

MARK INFORMATION

NJG1740 MHH (TE1)
 | | |
 Part number Package Taping form

ORDERING INFORMATION

PART NUMBER	PACKAGE OUTLINE	RoHS	HALOGEN-FREE	TERMINAL FINISH	MARKING	WEIGHT (mg)	MOQ (pcs.)
NJG1740MHH	EQFN26-HH	Yes	Yes	Sn-Bi	1740	1.89	1,500

ABSOLUTE MAXIMUM RATINGS

$T_a = 25^\circ\text{C}$, $Z_s = Z_l = 50 \Omega$

PARAMETER	SYMBOL	RATINGS	UNIT
Supply voltage	V_{DD}	6.0	V
Inspection voltage	$V_{in}^{(1)}$	$V_{DD} + 0.3$	V
Input power	P_{IN}	+15 ⁽²⁾	dBm
Power dissipation	P_D	2200 ⁽³⁾	mW
Operating temperature	T_{opr}	-40 to +105	$^\circ\text{C}$
Storage temperature	T_{stg}	-55 to +150	$^\circ\text{C}$

(1): V_{in} is only applied to select manually LNA active mode or bypass mode for inspection. Please refer APPLICATION CIRCUIT for detail.

(2): $V_{DD} = 5\text{ V}$

(3): Mounted on four-layer FR4 PCB with through-hole (114.5 × 101.5 mm), $T_j = 150^\circ\text{C}$

POWER DISSIPATION VS. AMBIENT TEMPERATURE

Please, refer to the following Power Dissipation and Ambient Temperature.

(Please note the surface mount package has a small maximum rating of Power Dissipation [P_D], a special attention should be paid in designing of thermal radiation.)

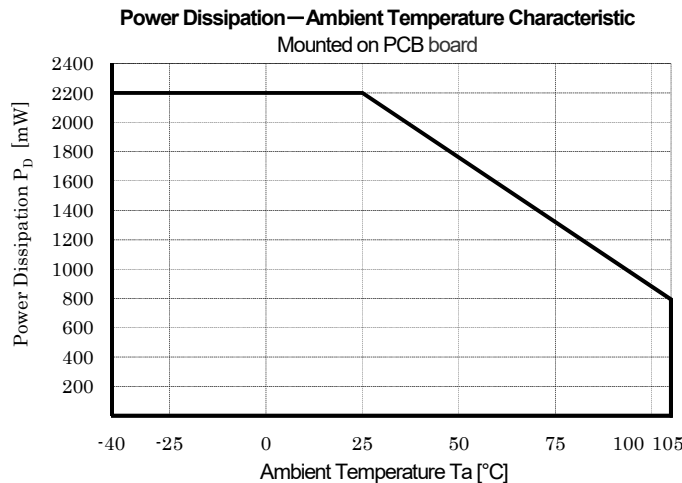

ELECTRICAL CHARACTERISTICS 1 (DC CHARACTERISTICS)

$T_a = 25^\circ\text{C}$, with application circuit

PARAMETER	SYMBOL	TEST CONDITION	MIN.	TYP.	MAX.	UNIT
Supply voltage	V_{DD}		4.7	5.0	5.5	V
Operating current 1	I_{DD1}	LNA active mode	-	40	100	mA
Operating current 2	I_{DD2}	Bypass mode	-	10	20	mA

■ ELECTRICAL CHARACTERISTICS 2 (LNA active mode)

$V_{DD} = 5V$, freq = 40 to 780 MHz, $T_a = 25^\circ C$, $Z_s = Z_l = 50 \Omega$, with application circuit

PARAMETER	SYMBOL	TEST CONDITION	MIN.	TYP.	MAX.	UNIT
Small signal gain	Gain	Exclude PCB & connector losses (Note1)	15.0	18.0	21.0	dB
Noise figure1_1	NF1_1	freq = 40 to 174 MHz, exclude PCB & connector losses (Note2)	-	1.2	2.0	dB
Noise figure 1_2	NF1_2	freq = 174 to 780 MHz, exclude PCB & connector losses (Note2)	-	0.9	1.3	dB
3rd order intermodulation distortion1	IM3_1	f1 = freq, f2 = freq + 100 kHz Pin = -60 dBm	-	-	-105	dBm
Input 3rd order intercept point1	IIP3_1	f1 = freq, f2 = freq + 100 kHz Pin = -45 dBm (Note 3)	-15	-5.0	-	dBm
RFIN port return loss1	RLi1		4.5	7.5	-	dB
RFOUT port return loss 1	RLo1		8.0	14.0	-	dB

■ ELECTRICAL CHARACTERISTICS 3 (Bypass mode)

$V_{DD} = 5V$, freq = 40 to 780 MHz, $T_a = 25^\circ C$, $Z_s = Z_l = 50\Omega$, with application circuit

PARAMETER	SYMBOL	TEST CONDITION	MIN.	TYP.	MAX.	UNIT
Insertion loss	Loss	Exclude PCB & connector losses (Note1)	-	1.0	3.0	dB
3rd order intermodulation distortion 2_1	IM3_2_1	f1 = 40 to 68 MHz, f2 = freq + 100 kHz, Pin = -34 dBm	-	-115	-100	dBm
3rd order intermodulation distortion 2_2	IM3_2_2	f1 = 68 to 240 MHz, f2 = freq + 100 kHz, Pin = -34 dBm	-	-105	-90	dBm
3rd order intermodulation distortion 2_3	IM3_2_3	f1 = 240 to 780 MHz, f2 = freq + 100 kHz, Pin = -34 dBm	-	-95	-80	dBm
Input 3rd order intercept point 2_1	IIP3_2_1	f1 = 40 to 68 MHz, f2 = freq + 100 kHz, Pin = -34 dBm (Note 3)	-2.0	+6.0	-	dBm
Input 3rd order intercept point 2_2	IIP3_2_2	f1 = 68 to 240 MHz, f2 = freq + 100 kHz, Pin = -34 dBm (Note 3)	-7.5	+1.0	-	dBm
Input 3rd order intercept point 2_3	IIP3_2_3	f1 = 240 to 780 MHz, f2 = freq + 100 kHz, Pin = -34 dBm (Note 3)	-12.5	-4.0	-	dBm
RFIN port return loss 2	RLi2		7.5	14.0	-	dB
RFOUT port return loss 2	RLo2		7.5	14.0	-	dB

(Note1) Input and output PCB, connector losses: 0.01 dB (40 MHz), 0.03 dB (174 MHz), 0.09 dB (620 MHz), 0.11 dB (780 MHz)

(Note2) Input PCB and connector losses: 0.01 dB (40 MHz), 0.02 dB (174 MHz), 0.04 dB (620 MHz), 0.05 dB (780 MHz)

(Note3) $IIP3 = OIP3 - \text{Gain}$, $OIP3 = (3 * P_{out} - IM3) / 2$

■ HYSTERESIS OPERATION IMAGE

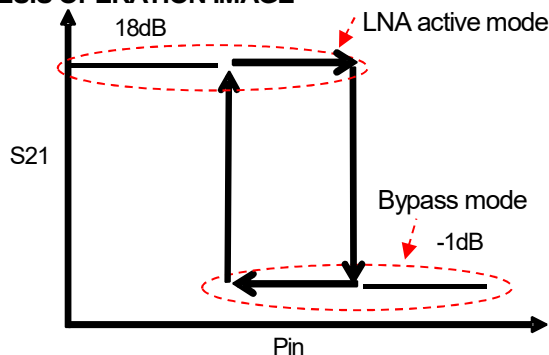

■ ELECTRICAL CHARACTERISTICS (LNA active mode)

General condition: $V_{DD} = 5.0\text{ V}$, $T_a = 25^\circ\text{C}$, $Z_s = Z_L = 50\ \Omega$, with application circuit

Gain, NF vs. Frequency

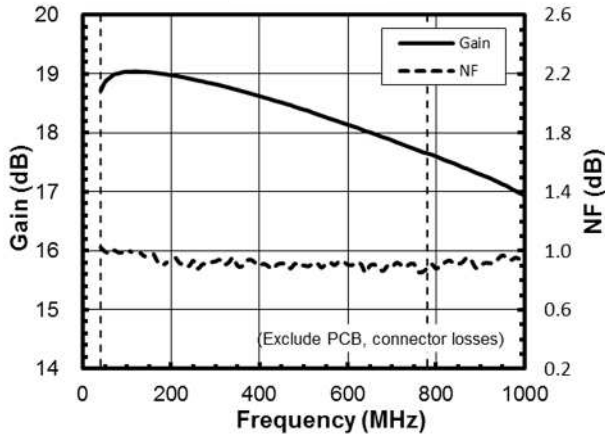

Reverse Isolation vs. Frequency

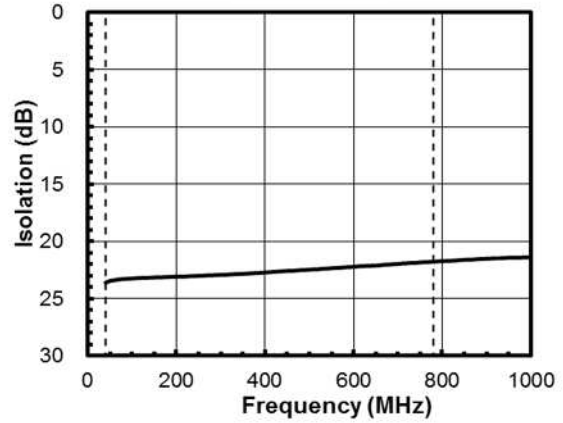

RFIN Return Loss vs. Frequency

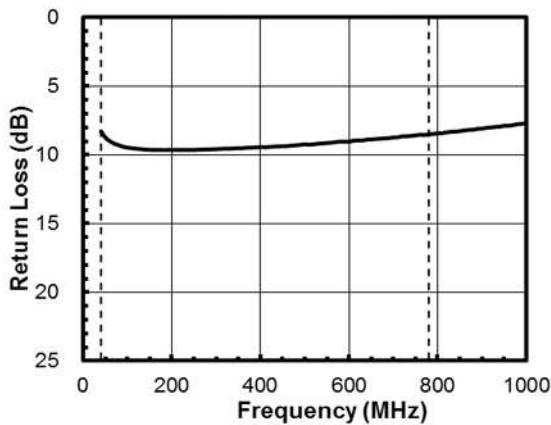

RFOUT Return Loss vs. Frequency

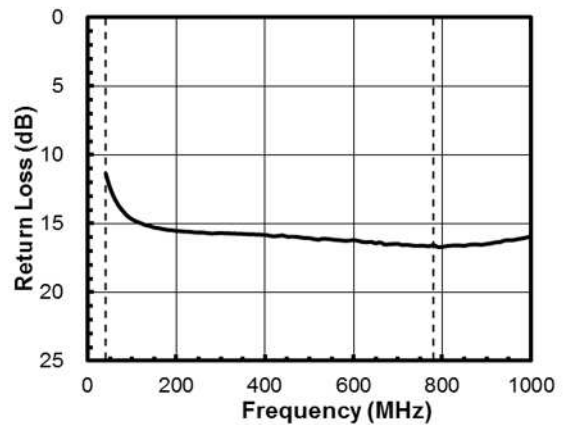

S11, S22 vs. Frequency

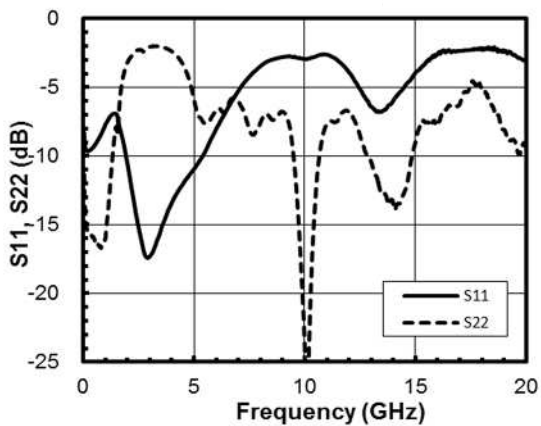

S21, S12 vs. Frequency

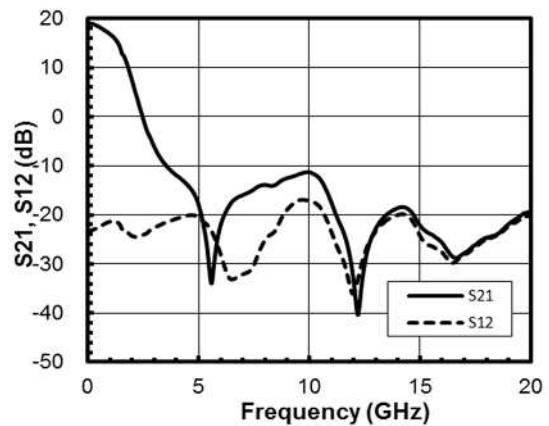

■ ELECTRICAL CHARACTERISTICS (LNA active mode)

General condition: $V_{DD} = 5.0\text{ V}$, $T_a = 25^\circ\text{C}$, $Z_s = Z_L = 50\ \Omega$, with application circuit

K factor vs. Frequency

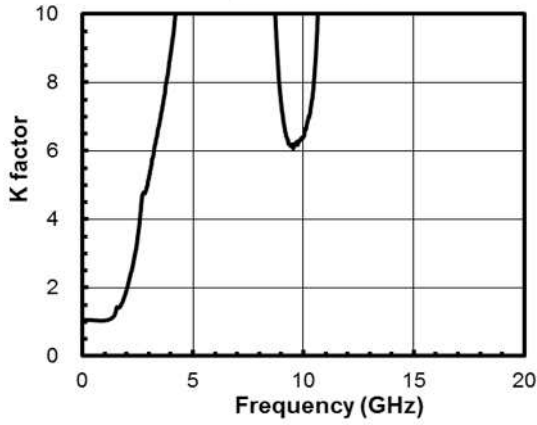

IM3 vs. Frequency

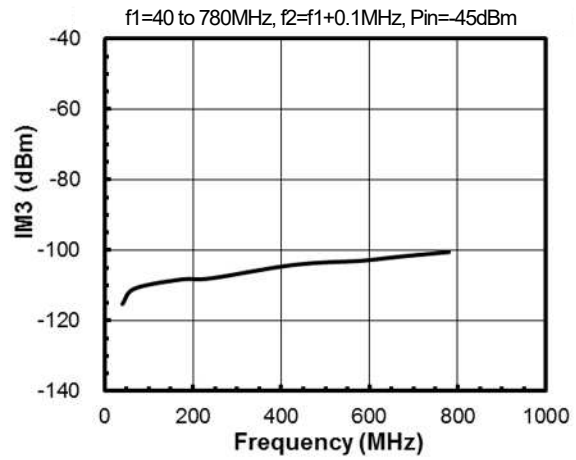

IIP3 vs. Frequency

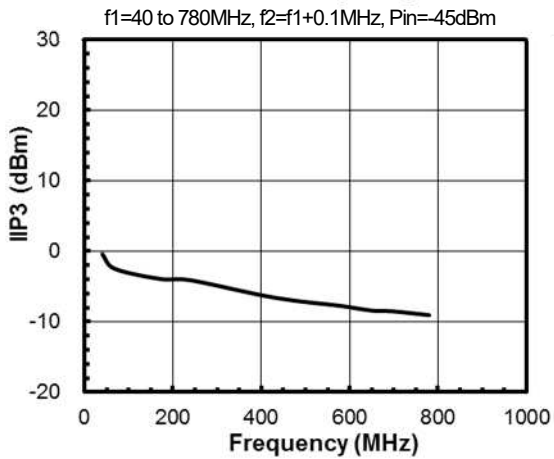

■ ELECTRICAL CHARACTERISTICS (Bypass mode)

General condition: $V_{DD} = 5.0\text{ V}$, $T_a = 25^\circ\text{C}$, $Z_s = Z_l = 50\ \Omega$, with application circuit

Loss vs. Frequency

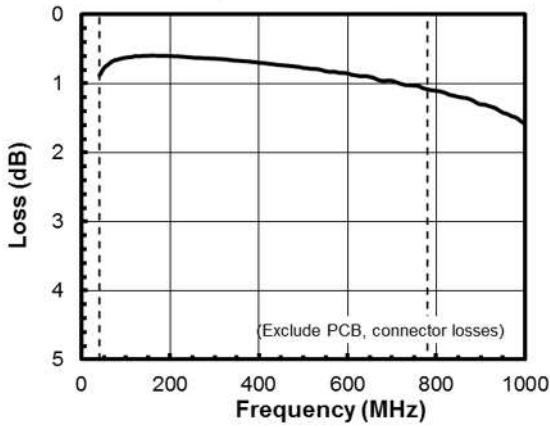

RFIN Return Loss vs. Frequency

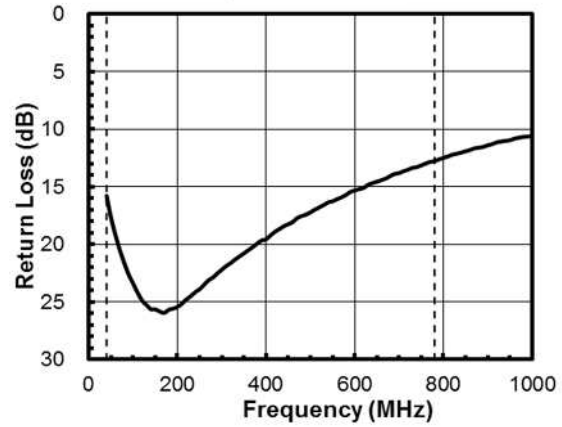

RFOUT Return Loss vs. Frequency

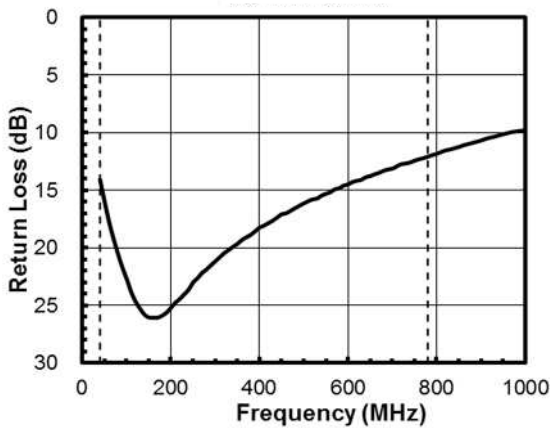

IM3 vs. Frequency

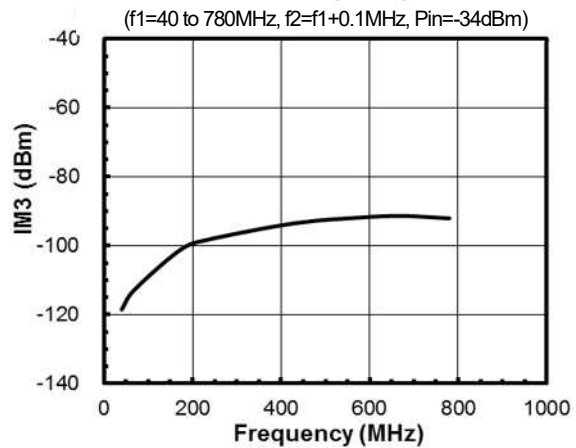

IIP3 vs. Frequency

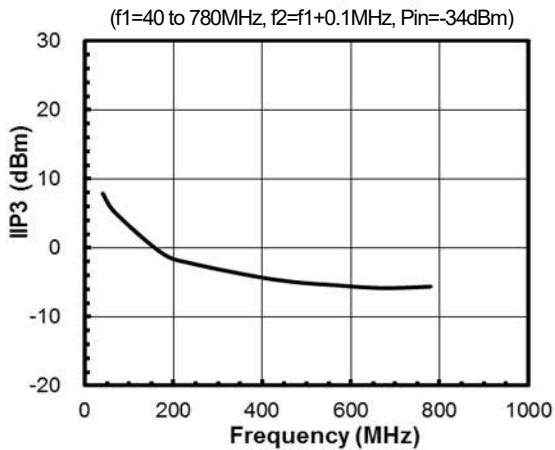

■ ELECTRICAL CHARACTERISTICS (LNA active mode)

General condition: $V_{DD} = 5.0\text{ V}$, $Z_s = Z_l = 50\ \Omega$, with application circuit

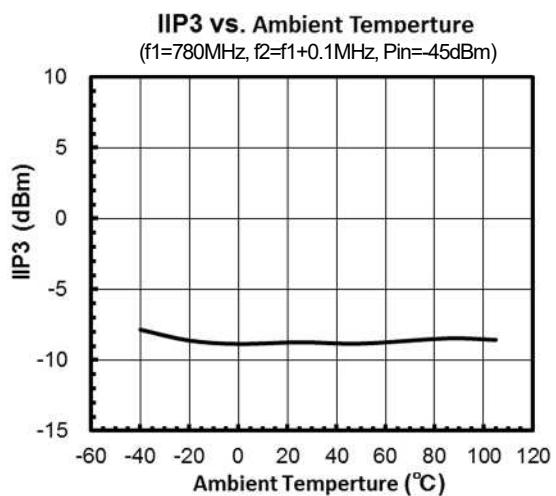
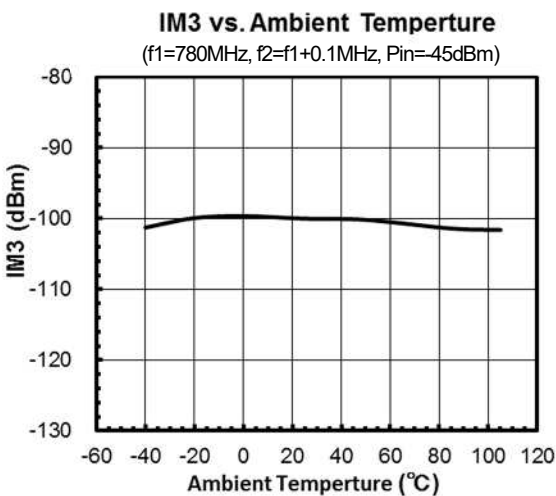
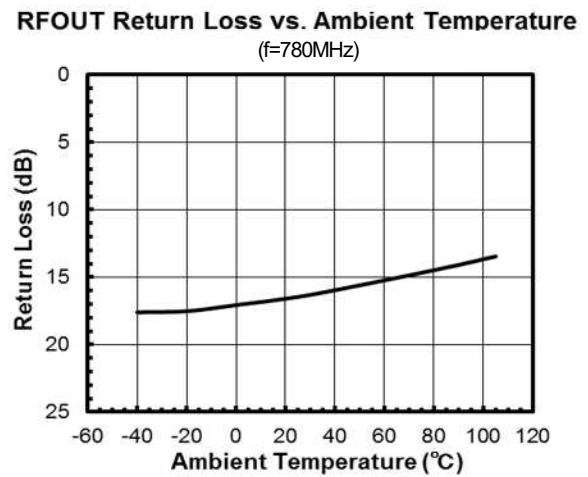
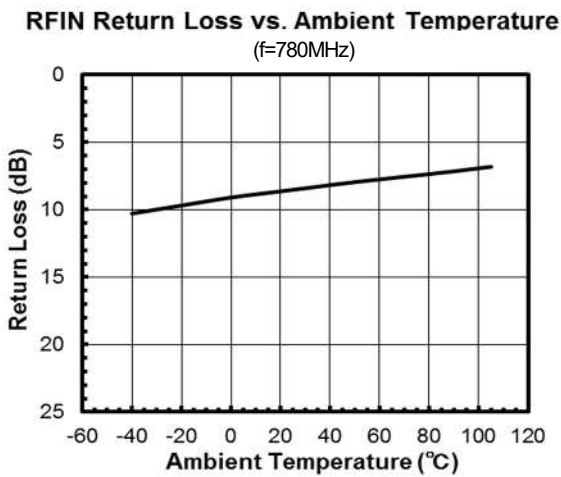
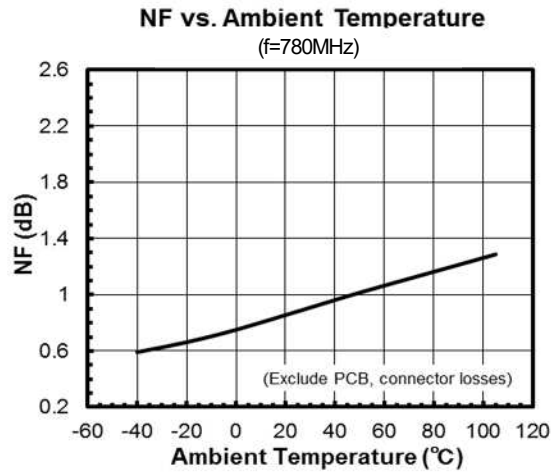
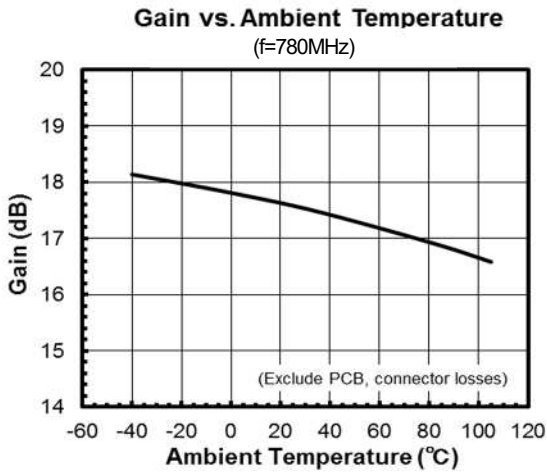

■ ELECTRICAL CHARACTERISTICS (Bypass mode)

General condition: $V_{DD} = 5.0\text{ V}$, $Z_s = Z_l = 50\ \Omega$, with application circuit

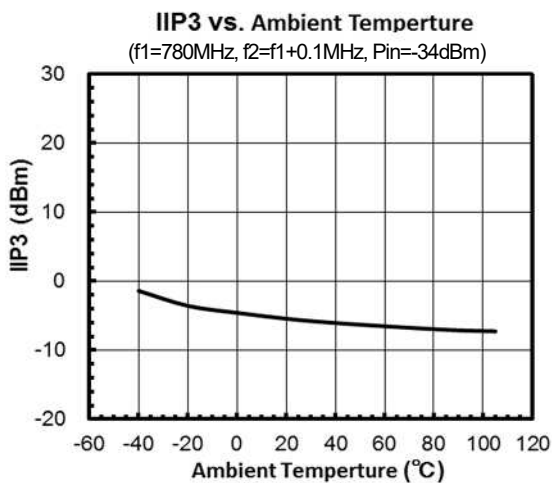
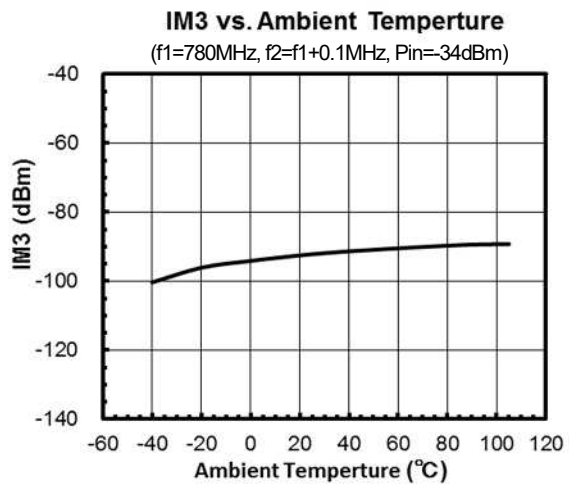
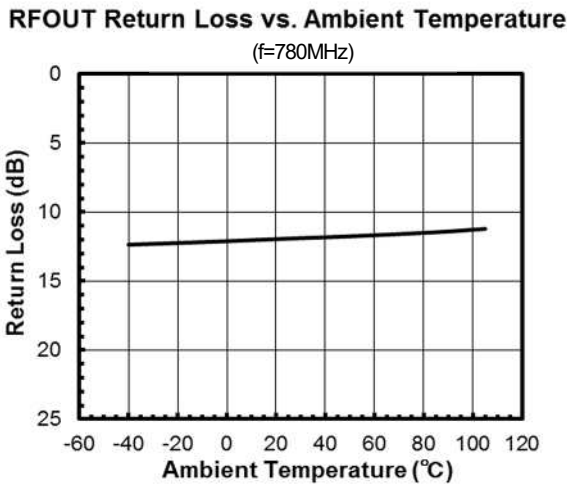
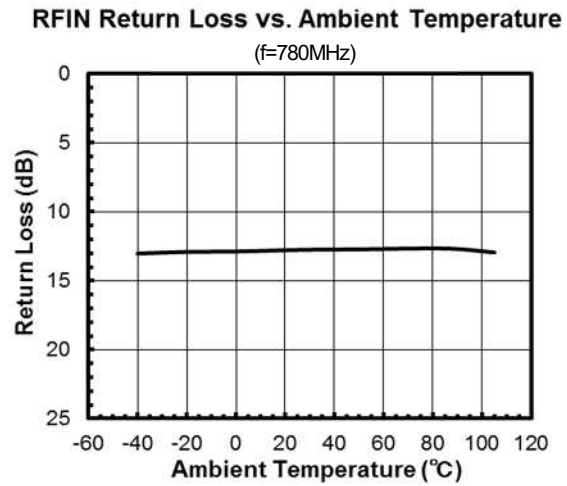
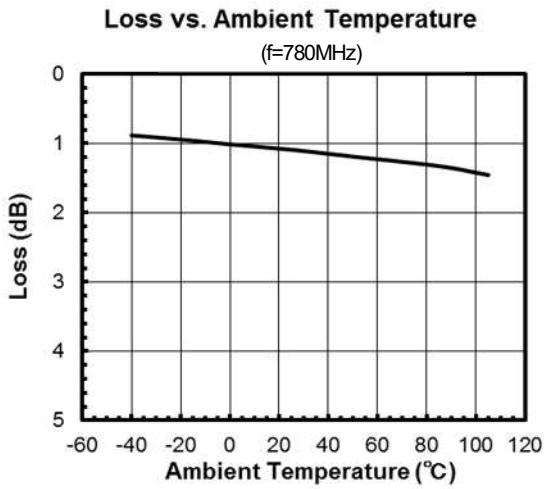

■ ELECTRICAL CHARACTERISTICS (LNA active mode)

General condition: $T_a = 25^\circ\text{C}$, $Z_s = Z_l = 50\ \Omega$, with application circuit

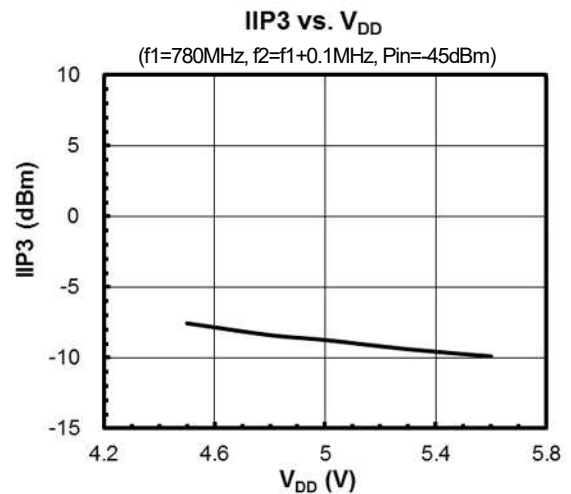
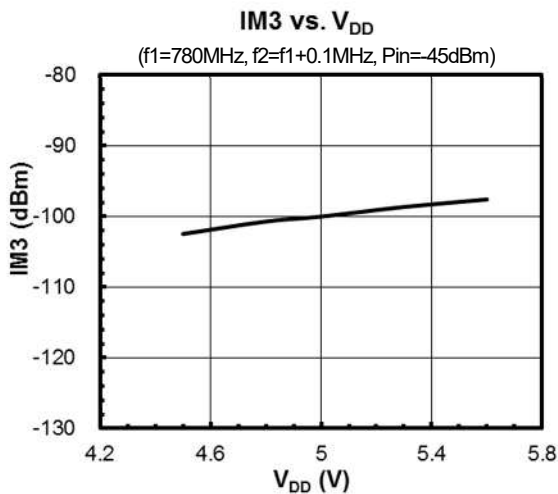
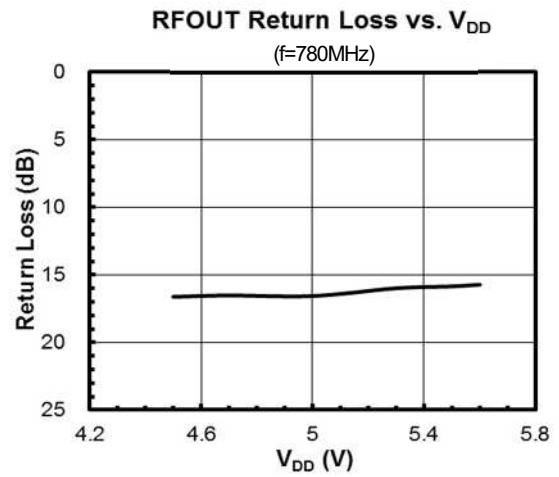
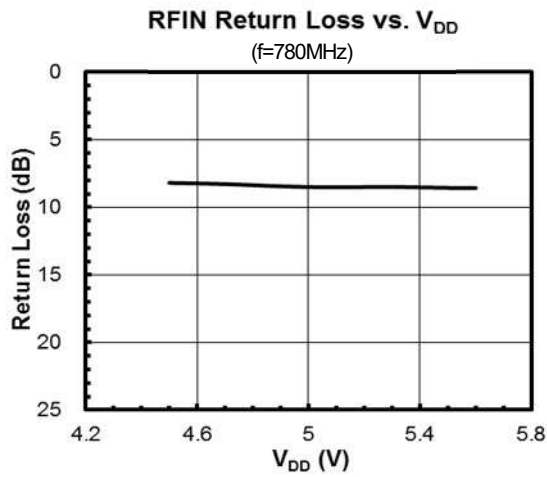
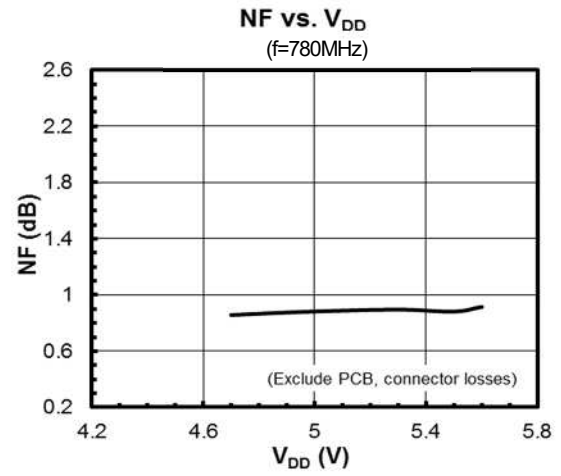
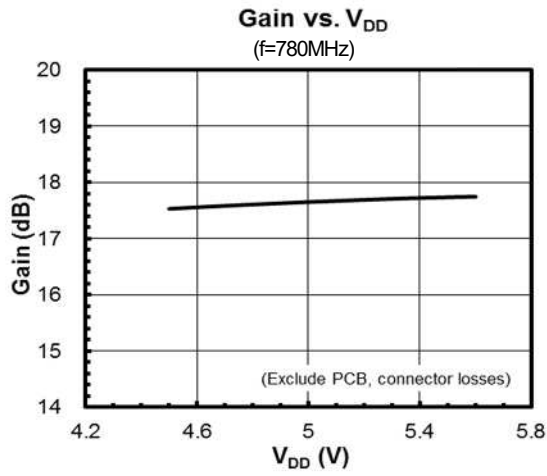

■ ELECTRICAL CHARACTERISTICS (Bypass mode)

General condition: $T_a = 25^\circ\text{C}$, $Z_s = Z_l = 50 \Omega$, with application circuit

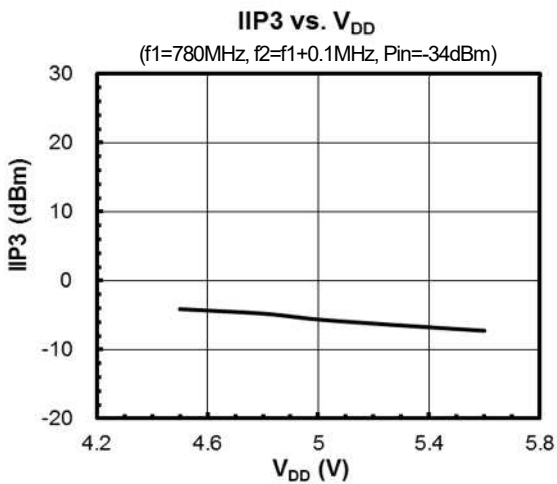
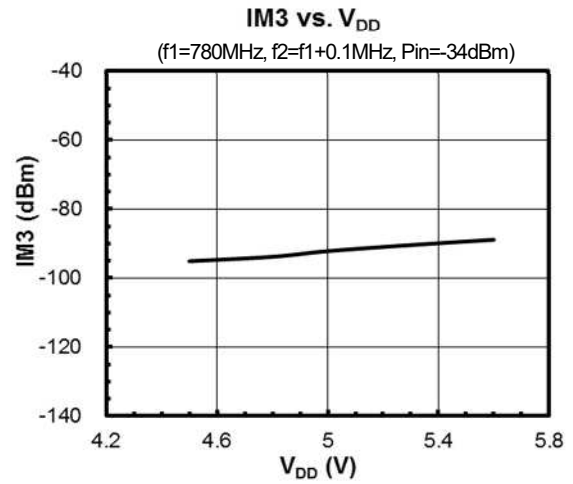
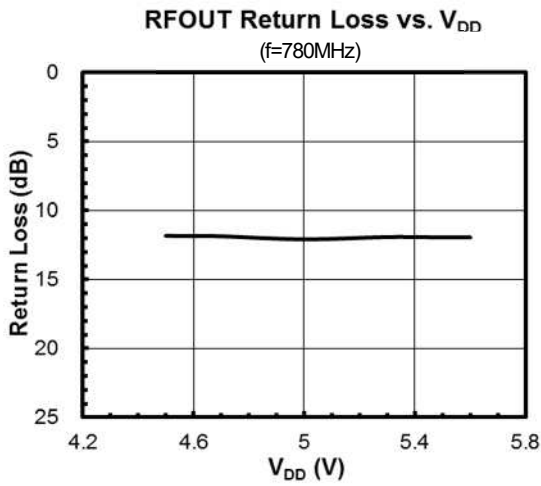
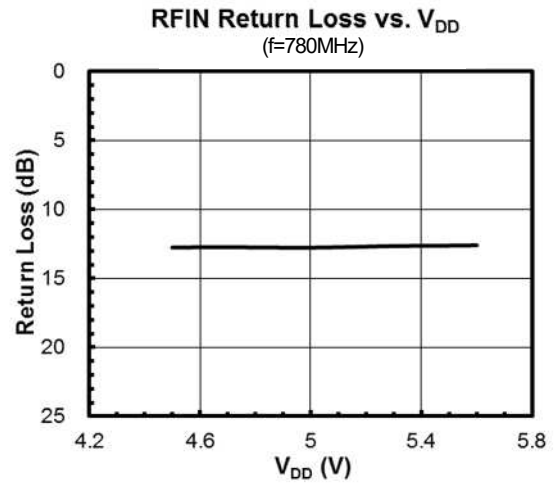
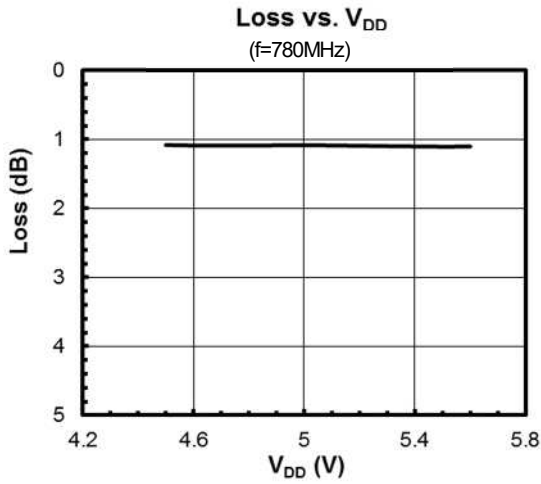

■ ELECTRICAL CHARACTERISTICS (Auto gain control)

General condition: $V_{DD} = 5.0V$, $T_a = 25^\circ C$, $Z_s = Z_l = 50 \Omega$, with application circuit

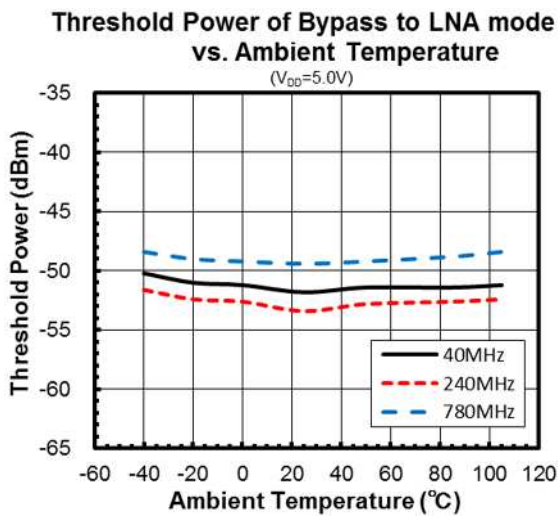
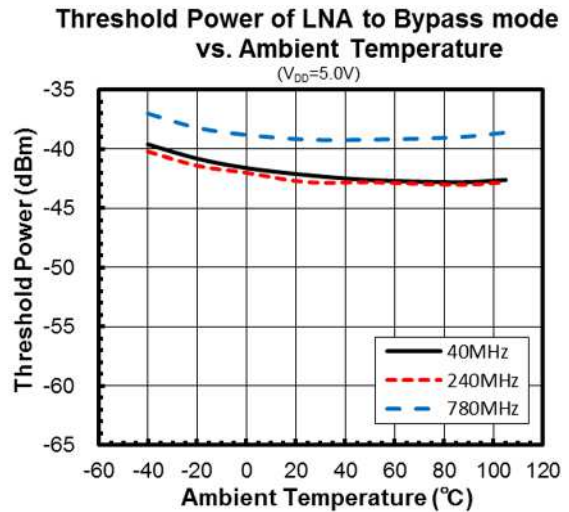
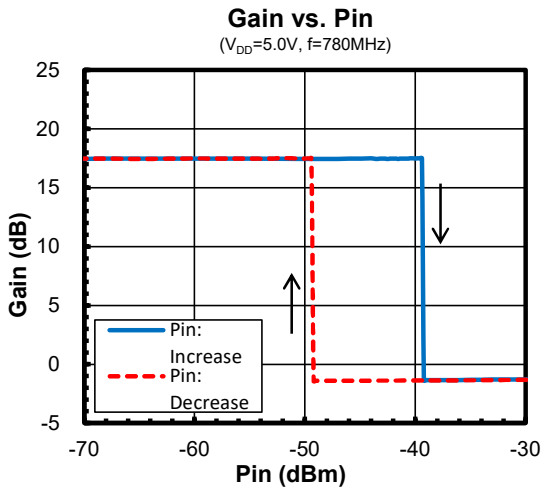
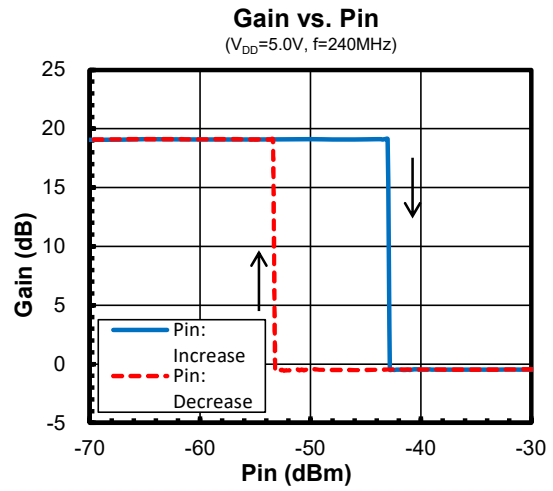
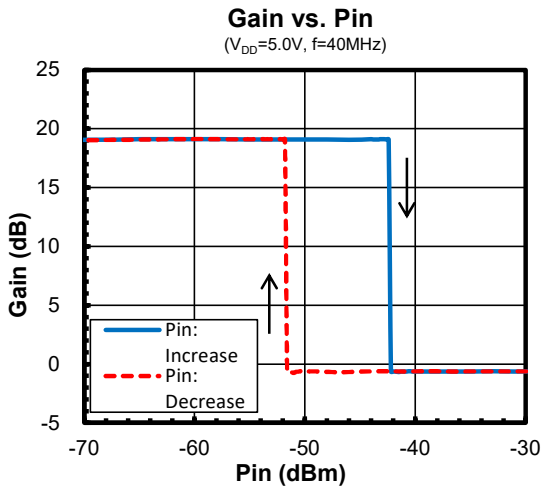

APPLICATION CIRCUIT

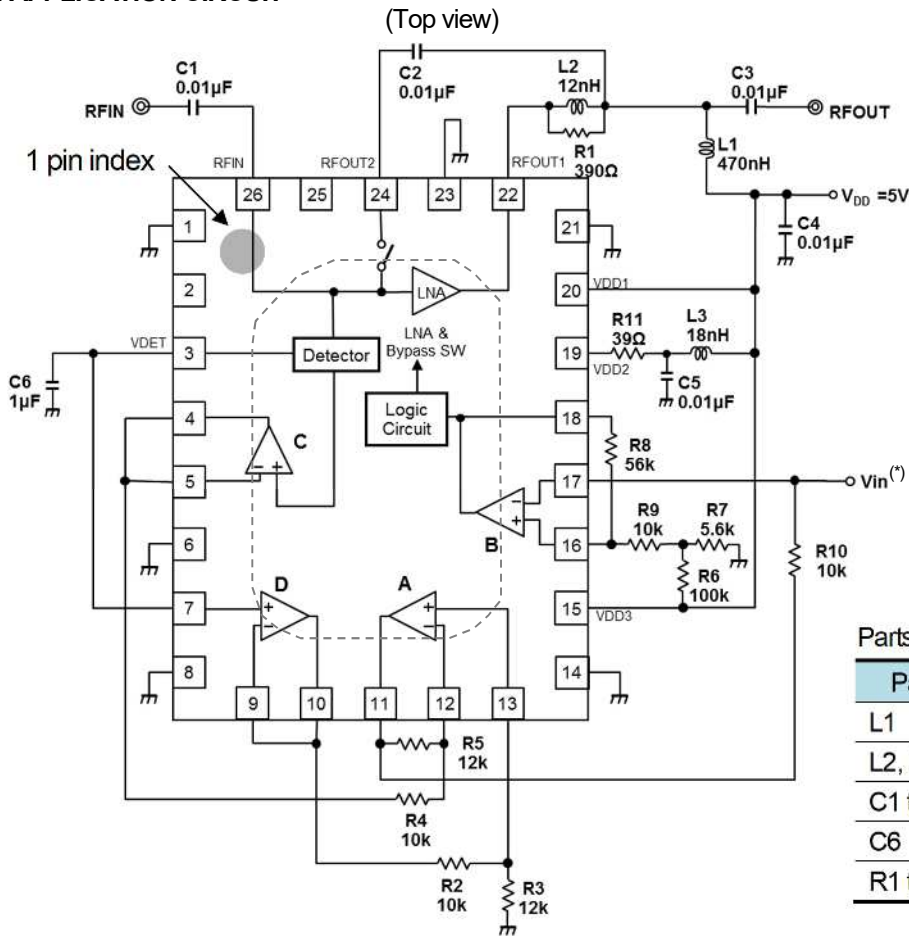

<Equivalent circuit>

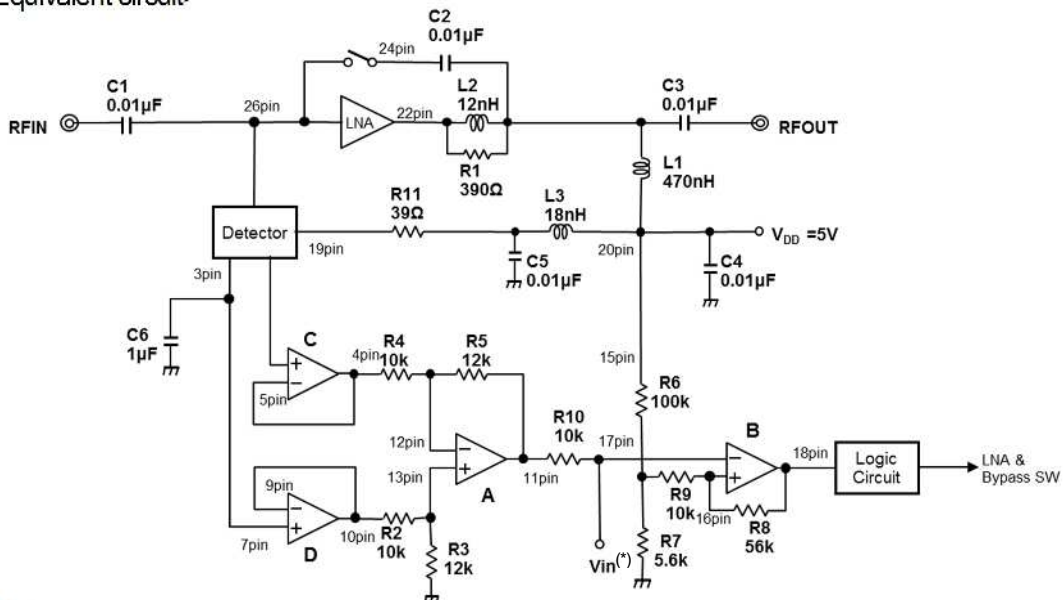

<Note>

* Regarding V_{in} , please keep open normally and not applying voltage externally when auto gain control function is used.

Applying voltage to V_{in} is only used to select manually and inspect performance of LNA active mode or bypass mode as below:

$V_{in} = 0V \rightarrow$ LNA active mode

$V_{in} = 5V \rightarrow$ Bypass mode

■NF MEASUREMENT BLOCK DIAGRAM

Measuring instruments

NF Analyzer : Keysight N8975A
 Noise Source : Keysight 346A

Setting the NF analyzer

Measurement mode form

Device under test : Amplifier
 System downconverter : off

Mode setup form

Sideband : LSB
 Averages : 4
 Average mode : Point
 Bandwidth : 4 MHz
 Loss comp : off
 Tcold : setting the temperature of noise source (303 K)

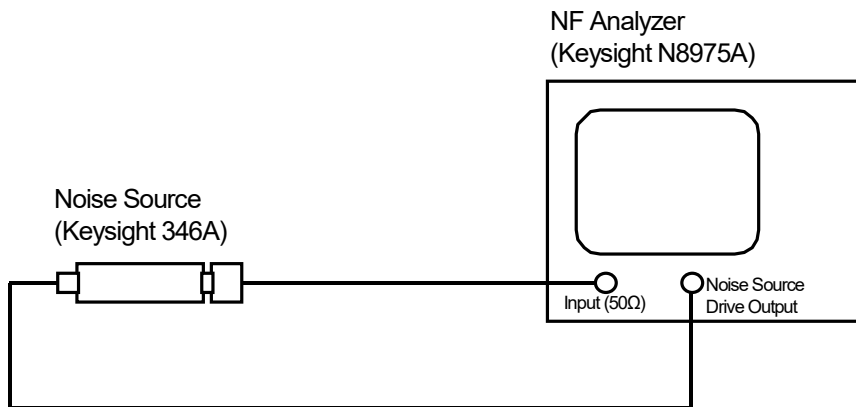

* Noise source and NF analyzer are connected directly.

Calibration Setup

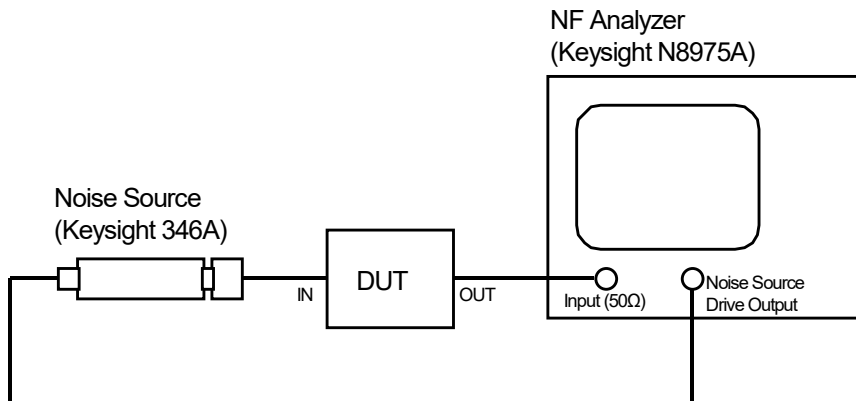

* Noise source and DUT, DUT and NF analyzer are connected directly.

Measurement Setup

■ EVALUATION BOARD

(Top View)

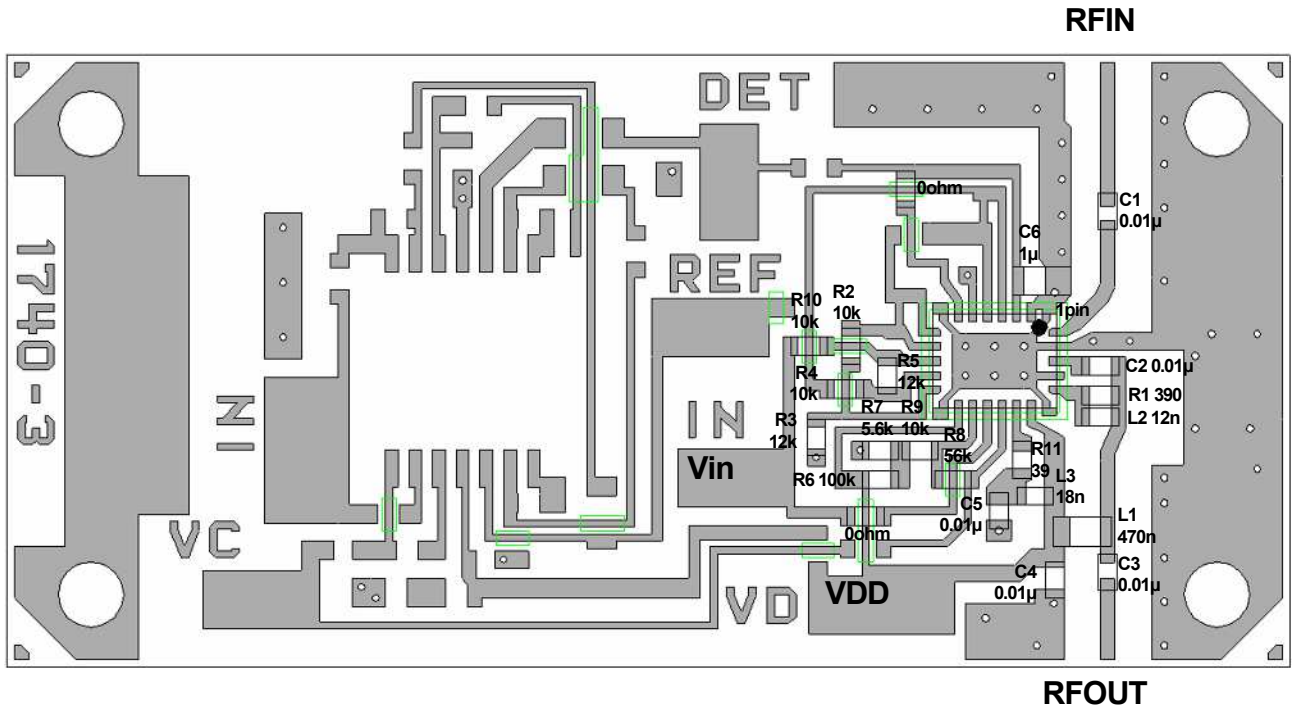



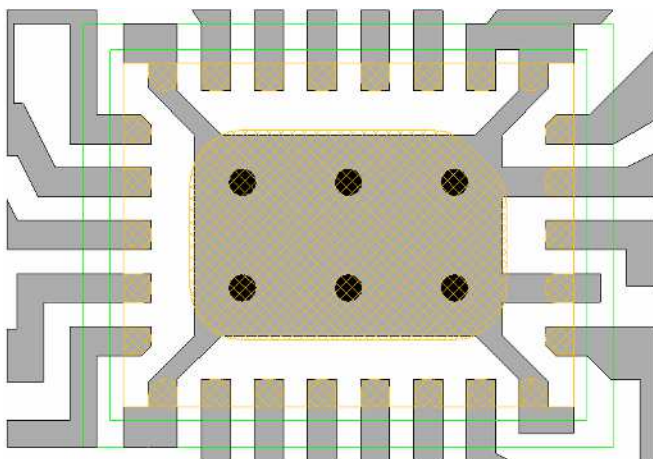

PCB Information

Substrate:	FR-4
Thickness:	0.2 mm
Micro strip line width:	0.4 mm ($Z_0 = 50 \Omega$)
Size:	35.2 mm x 16.8 mm

<PCB LAYOUT GUIDELINE>





-  PCB
-  PKG Terminal
-  PKG Outline
-  GND Via Hole
Diameter: $\phi = 0.2$ mm
-  Resist pattern

PRECAUTIONS

- All external parts should be placed as close as possible to the IC.
- For good RF performance, all GND terminals must be connected to PCB ground plane of substrate, and via-holes for GND should be placed near the IC.
- In order not to couple with terminal RFIN and RFOUT, please layout ground pattern between both terminals.

RECOMMENDED FOOTPRINT PATTERN (EQFN26-HH)

-  : Land
-  : Mask (Open area) *Metal mask thickness : 100 μm
-  : Resist (Open area)

PKG: 3.4 mm x 2.6 mm
Pin pitch: 0.4 mm

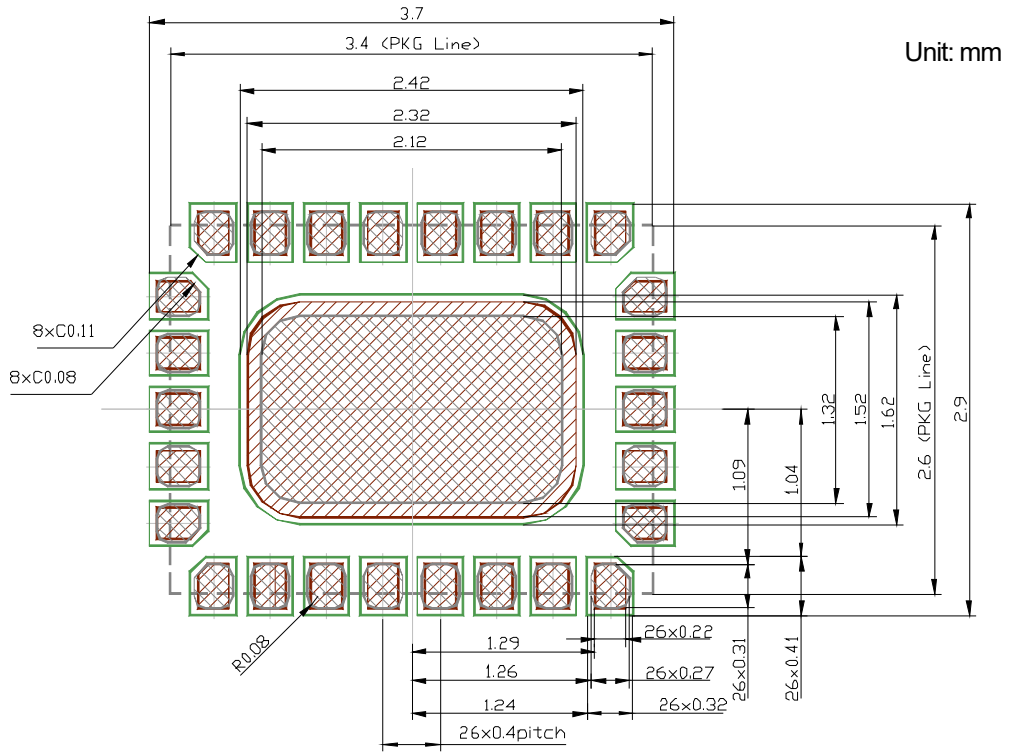

■ PACKAGE OUTLINE (EQFN26-HH)

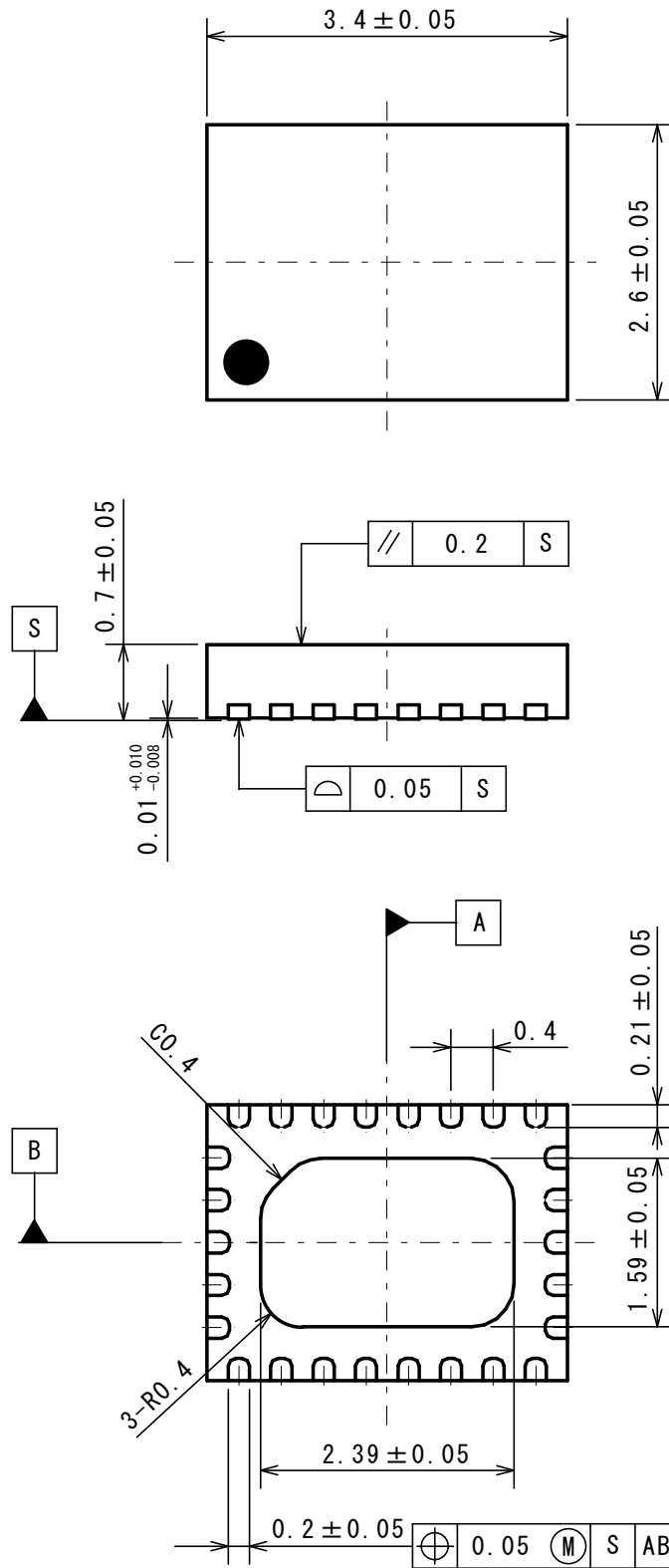

Units	: mm
Board	: Cu
Terminal treat	: SnBi
Molding material	: Epoxy resin
Weight	: 18 mg

PACKING SPECIFICATION (EQFN26-HH)

Unit: mm

TAPING DIMENSIONS

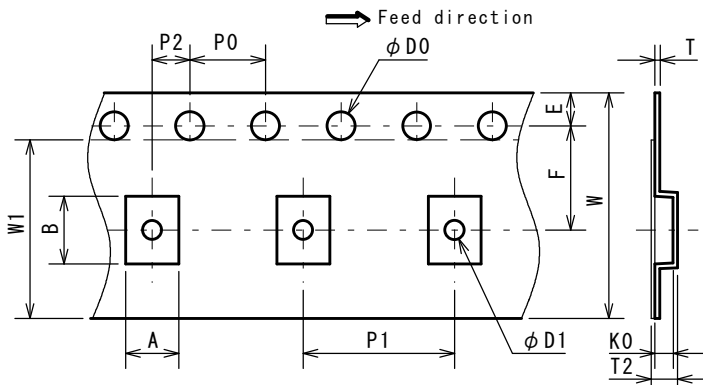

SYMBOL	DIMENSION	REMARKS
A	2.8±0.05	BOTTOM DIMENSION
B	3.6±0.05	BOTTOM DIMENSION
D0	1.5 ^{+0.1} ₀	
D1	1.0 ^{+0.1} ₀	
E	1.75±0.1	
F	5.5±0.05	
P0	4.0±0.1	
P1	8.0±0.1	
P2	2.0±0.05	
T	0.25±0.05	
T2	1.2	
K0	0.85±0.05	
W	12.0 ^{+0.3} _{-0.1}	
W1	9.5	THICKNESS 0.1max

REEL DIMENSIONS

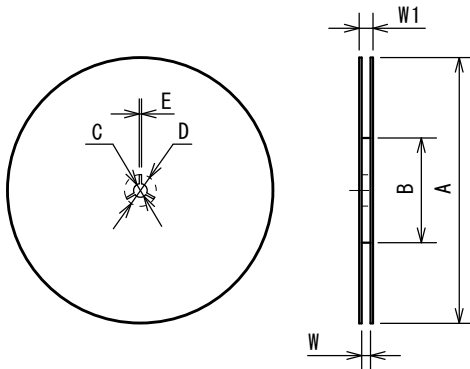

SYMBOL	DIMENSION
A	φ 180 ⁰ ₋₃
B	φ 60 ⁺¹ ₀
C	φ 13±0.2
D	φ 21±0.8
E	2±0.5
W	13 ^{+1.0} ₀
W1	15.4±1.0

TAPING STATE

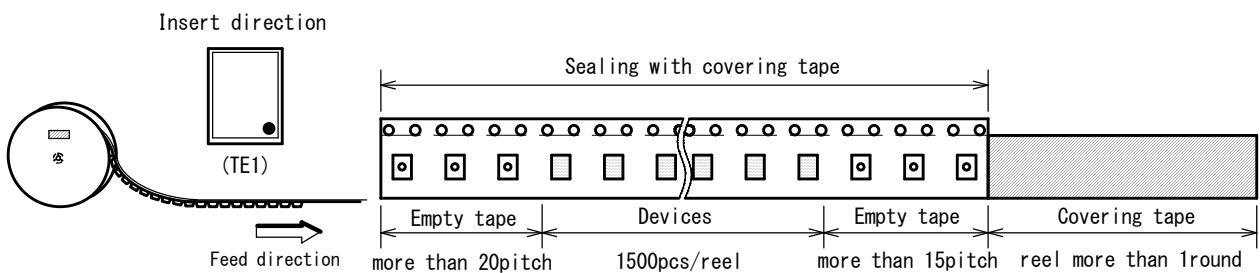

PACKING STATE

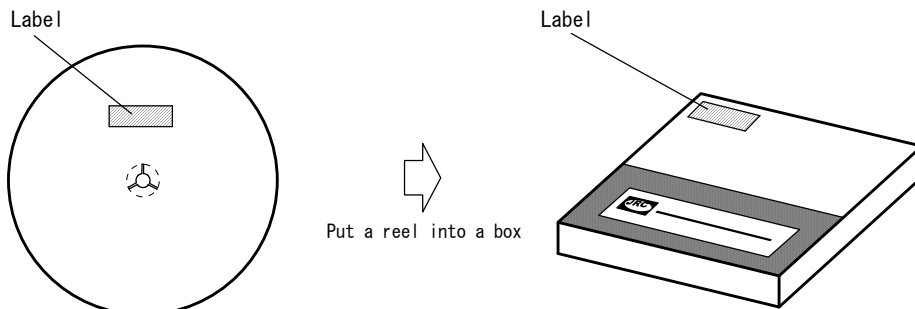

1. The products and the product specifications described in this document are subject to change or discontinuation of production without notice for reasons such as improvement. Therefore, before deciding to use the products, please refer to our sales representatives for the latest information thereon.
2. The materials in this document may not be copied or otherwise reproduced in whole or in part without the prior written consent of us.
3. This product and any technical information relating thereto are subject to complementary export controls (so-called KNOW controls) under the Foreign Exchange and Foreign Trade Law, and related politics ministerial ordinance of the law. (Note that the complementary export controls are inapplicable to any application-specific products, except rockets and pilotless aircraft, that are insusceptible to design or program changes.) Accordingly, when exporting or carrying abroad this product, follow the Foreign Exchange and Foreign Trade Control Law and its related regulations with respect to the complementary export controls.
4. The technical information described in this document shows typical characteristics and example application circuits for the products. The release of such information is not to be construed as a warranty of or a grant of license under our or any third party's intellectual property rights or any other rights.
5. The products listed in this document are intended and designed for use as general electronic components in standard applications (office equipment, telecommunication equipment, measuring instruments, consumer electronic products, amusement equipment etc.). Those customers intending to use a product in an application requiring extreme quality and reliability, for example, in a highly specific application where the failure or misoperation of the product could result in human injury or death should first contact us.
 - Aerospace Equipment
 - Equipment Used in the Deep Sea
 - Power Generator Control Equipment (nuclear, steam, hydraulic, etc.)
 - Life Maintenance Medical Equipment
 - Fire Alarms / Intruder Detectors
 - Vehicle Control Equipment (automotive, airplane, railroad, ship, etc.)
 - Various Safety Devices
 - Traffic control system
 - Combustion equipment

In case your company desires to use this product for any applications other than general electronic equipment mentioned above, make sure to contact our company in advance. Note that the important requirements mentioned in this section are not applicable to cases where operation requirements such as application conditions are confirmed by our company in writing after consultation with your company.

6. We are making our continuous effort to improve the quality and reliability of our products, but semiconductor products are likely to fail with certain probability. In order to prevent any injury to persons or damages to property resulting from such failure, customers should be careful enough to incorporate safety measures in their design, such as redundancy feature, fire containment feature and fail-safe feature. We do not assume any liability or responsibility for any loss or damage arising from misuse or inappropriate use of the products.
7. The products have been designed and tested to function within controlled environmental conditions. Do not use products under conditions that deviate from methods or applications specified in this datasheet. Failure to employ the products in the proper applications can lead to deterioration, destruction or failure of the products. We shall not be responsible for any bodily injury, fires or accident, property damage or any consequential damages resulting from misuse or misapplication of the products.
8. **Quality Warranty**
 - 8-1. **Quality Warranty Period**

In the case of a product purchased through an authorized distributor or directly from us, the warranty period for this product shall be one (1) year after delivery to your company. For defective products that occurred during this period, we will take the quality warranty measures described in section 8-2. However, if there is an agreement on the warranty period in the basic transaction agreement, quality assurance agreement, delivery specifications, etc., it shall be followed.
 - 8-2. **Quality Warranty Remedies**

When it has been proved defective due to manufacturing factors as a result of defect analysis by us, we will either deliver a substitute for the defective product or refund the purchase price of the defective product.

Note that such delivery or refund is sole and exclusive remedies to your company for the defective product.
 - 8-3. **Remedies after Quality Warranty Period**

With respect to any defect of this product found after the quality warranty period, the defect will be analyzed by us. On the basis of the defect analysis results, the scope and amounts of damage shall be determined by mutual agreement of both parties. Then we will deal with upper limit in Section 8-2. This provision is not intended to limit any legal rights of your company.
9. Anti-radiation design is not implemented in the products described in this document.
10. The X-ray exposure can influence functions and characteristics of the products. Confirm the product functions and characteristics in the evaluation stage.
11. WLCSP products should be used in light shielded environments. The light exposure can influence functions and characteristics of the products under operation or storage.
12. Warning for handling Gallium and Arsenic (GaAs) products (Applying to GaAs MMIC, Photo Reflector). These products use Gallium (Ga) and Arsenic (As) which are specified as poisonous chemicals by law. For the prevention of a hazard, do not burn, destroy, or process chemically to make them as gas or power. When the product is disposed of, please follow the related regulation and do not mix this with general industrial waste or household waste.
13. Please contact our sales representatives should you have any questions or comments concerning the products or the technical information.



Nisshinbo Micro Devices Inc.

Official website

<https://www.nisshinbo-microdevices.co.jp/en/>

Purchase information

<https://www.nisshinbo-microdevices.co.jp/en/buy/>

Looking for pricing, stock, or lifecycle information?

Click below to explore more details on WIN SOURCE:

- ⊖ [View NJG1740MHH-TE1 on WIN SOURCE](#)
- ⊖ [Nisshinbo Micro Devices Inc. Information](#)

Optimize Your Supply Chain with WIN SOURCE Solutions

- ✓ Global Sourcing Solution
- ✓ Obsolete Management
- ✓ Cost Control Management
- ✓ Shortage Management
- ✓ Alternative Solution
- ✓ Excess Inventory Management