

### Product Overview

Qorvo's QPA0015 is a high power, packaged Ku-Band MMIC amplifier fabricated using Qorvo's production 0.15 um GaN-on-SiC process (QGaN15). The QPA0015 targets the 13.75-14.5 GHz Satcom band while providing 3-Watts of linear power with third-order intermodulation distortion products of 25 dBc. Furthermore, the QPA0015 can deliver output powers up to 8-Watts with 35 dB of small-signal gain and 32% power-added efficiency. The operating frequency can extend to 12.75-15.35 GHz if desired.

To simplify system integration, the QPA0015 is fully matched to 50 ohms with DC grounded I/O ports for optimum ESD performance. Also, there are on-chip blocking capacitors following the DC grounds on the input and output ports.

The QPA0015 is ideal for supporting communications and radar applications in both commercial and military markets.

The QPA0015 is 100% DC and RF tested to ensure compliance to electrical specifications.

Lead-free and RoHS compliant

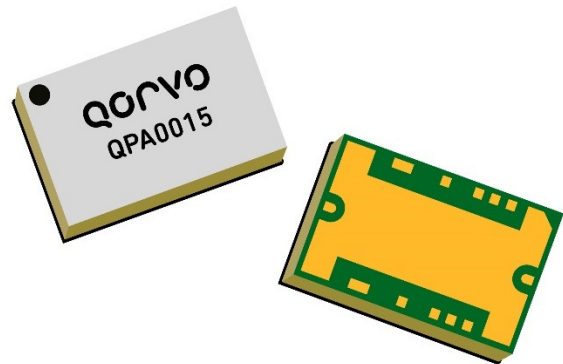

### Key Features

- Frequency Range: 13.75 – 14.5 GHz
- Extended Frequency Range: 12.75 – 15.35 GHz
- Linear P<sub>OUT</sub>: 35 dBm
- P<sub>OUT</sub> (P<sub>IN</sub> = 10 dBm): 39 dBm
- PAE (P<sub>IN</sub> = 10 dBm): 32 %
- IM3 (P<sub>OUT\_TOTAL</sub> = 35 dBm): -25 dBc
- Small Signal Gain: 35 dB
- Bias: V<sub>D</sub> = 24 V, I<sub>DQ</sub> = 195 mA, V<sub>G</sub> = -2.3 V typ. range
- Package Dimensions: 7.00 x 4.50 x 2.45 mm

*Performance is typical across frequency. Please reference electrical specification table and data plots for more details.*

### Functional Block Diagram

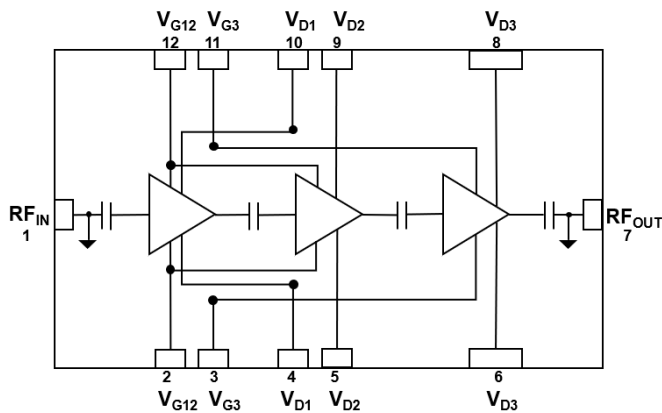

### Applications

- Satellite Communications
- Radar
- Datalinks

### Ordering Information

Part No.	Description
QPA0015	8 Watt GaN PA Package
QPA0015TR7	200 pieces on a 7" reel (standard)
QPA0015EVB	Evaluation Board



### Absolute Maximum Ratings

Parameter	Value / Range
Drain Voltage ( $V_D$ )	29.5 V
Gate Voltage Range ( $V_G$ )	-4 V to 0 V
Drain Current ( $I_{D12}$ ), 1-sided feed	885 mA
Drain Current ( $I_{D3}$ ), 1-sided feed	1700 mA
Drain Current Total ( $I_D$ ), 1-sided feed	2585 mA
Gate Current ( $I_G$ )	See p. 26
Power Dissipation ( $P_{DISS}$ ), CW, $T_{BASE} = 85\text{ }^\circ\text{C}$	30.5 W
Input Power ( $P_{IN}$ ), 50 $\Omega$ , CW, $V_D = 24\text{ V}$ , $I_{DQ} = 195\text{ mA}$ , $T_{BASE} = 85\text{ }^\circ\text{C}$	18 dBm
Input Power ( $P_{IN}$ ), 3:1 VSWR, CW, $V_D = 24\text{ V}$ , $I_{DQ} = 195\text{ mA}$ , $T_{BASE} = 85\text{ }^\circ\text{C}$	17 dBm
Mounting Temperature (30 seconds)	260 $^\circ\text{C}$
Storage Temperature	-55 to +150 $^\circ\text{C}$

Operation of this device outside the parameter ranges given above may cause permanent damage. These are stress ratings only, and functional operation of the device at these conditions is not implied.

### Recommended Operating Conditions

Parameter	Min	Typ.	Max	Unit
Drain Voltage ( $V_D$ ) – CW		24		V
Drain Current, Quiescent ( $I_{D12}$ )		131		mA
Drain Current, Quiescent ( $I_{D3}$ )		64		mA
Drain Current Total, Quiescent ( $I_{DQ} = I_{D12} + I_{D3}$ )		195		mA
Drain Current Total, RF ( $I_{D\_Drive}$ )	See plot page 5, 6, 10, 13, 16			mA
Gate Voltage Typ. Range ( $V_G$ )	-1.6 to -3			V
Gate Current, RF ( $I_{G\_Drive}$ )	See plot page 6			mA
$P_{IN}^{(1)}$	$T_{BASE} = -40\text{ }^\circ\text{C}$	8		dBm
	$T_{BASE} = +25\text{ }^\circ\text{C}$	10		
	$T_{BASE} = +85\text{ }^\circ\text{C}$	14		
Operating Temp. ( $T_{BASE}$ ) <sup>(2)</sup>	-40		+85	$^\circ\text{C}$

1. Compression is varied due to thermal, see p. 7, 8
2.  $T_{BASE}$  is back side of QPA0015 (see p. 29, offset temperature based on Qorvo's EVB design for reference).

Electrical specifications are measured at specified test conditions. Specifications are not guaranteed over all recommended operating conditions.

## Electrical Specifications

Parameter	Conditions <sup>(1)</sup> <sup>(2)</sup>	Min	Typ.	Max	Units
Operational Frequency Range		13.75 <sup>(3)</sup>		14.5 <sup>(3)</sup>	GHz
Linear Output Power			35		dBm
Output Power, P <sub>OUT</sub>	P <sub>IN</sub> = 10 dBm		39		dBm
Power Added Efficiency, PAE	P <sub>IN</sub> = 10 dBm		32		%
3 <sup>RD</sup> Intermodulation Products, IM3	P <sub>OUT_TOTAL</sub> = 35 dBm (P <sub>OUT/TONE</sub> = 32 dBm)		-25		dBc
5 <sup>TH</sup> Intermodulation Products, IM5			-40		
Small Signal Gain, S <sub>21</sub>	P <sub>IN</sub> = -30 dBm		35		dB
Input Return Loss, IRL			15		
Output Return Loss, ORL			6		
P <sub>SAT</sub> Temperature Coefficient	T <sub>DIFF</sub> = 25 °C to 85 °C; P <sub>IN</sub> = 10 dBm		-0.03		dBm/°C
S <sub>21</sub> Temperature Coefficient	T <sub>DIFF</sub> = 25 °C to 85 °C		-0.20		dB/°C

**Notes:**

1. Test conditions unless otherwise noted: CW, V<sub>D</sub> = 24 V, I<sub>DQ</sub> = 195 mA (I<sub>D12</sub> = 131 mA, I<sub>D3</sub> = 64 mA), V<sub>G</sub> = -2.3 V +/- 0.7V typical, T<sub>BASE</sub> = +25°C, Z<sub>0</sub> = 50 Ω (reference planes are at QPA0015).
2. T<sub>BASE</sub> is back side of QPA0015 (see page 28, offset temperature based on Qorvo's EVB design for reference).
3. Extended frequency range: 12.75 – 15.35 GHz

Performance Plots – Large Signal (CW)

Test conditions, unless otherwise noted: CW,  $V_D = 24\text{ V}$ ,  $I_{DQ} = 195\text{ mA}$  ( $I_{D12} = 131\text{ mA}$ ,  $I_{D3} = 64\text{ mA}$ ),  $P_{IN} = 10\text{ dBm}$ ,  $T_{BASE} = +25\text{ }^\circ\text{C}$  ( $T_{BASE}$  is backside of QPA0015).

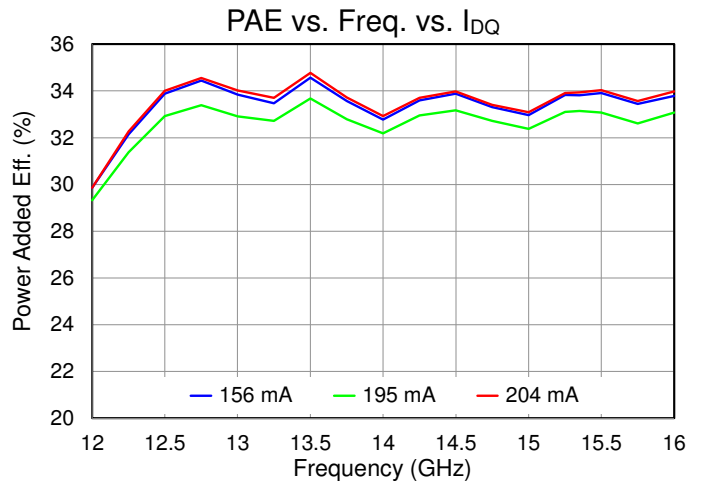
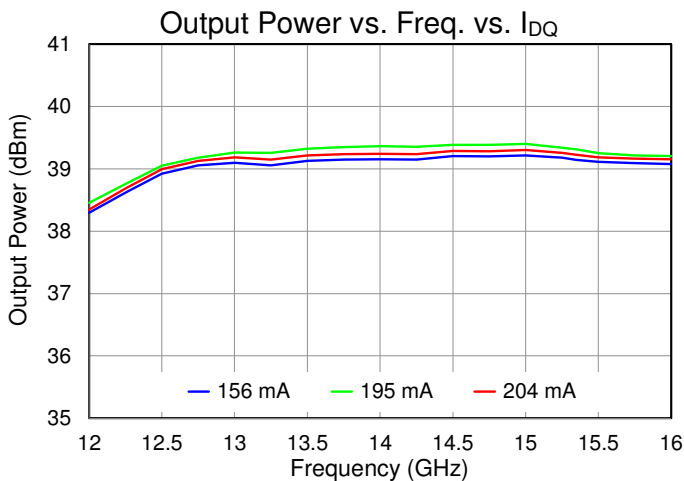
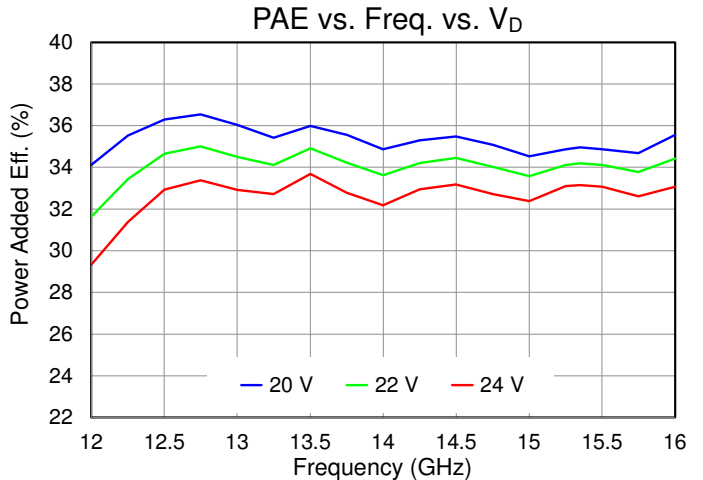
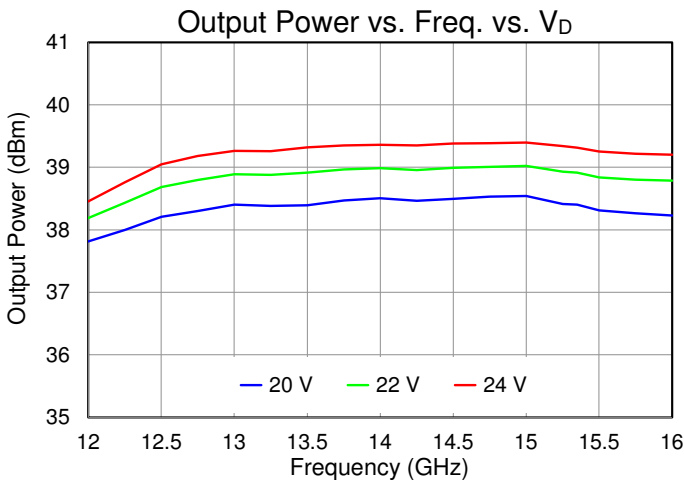
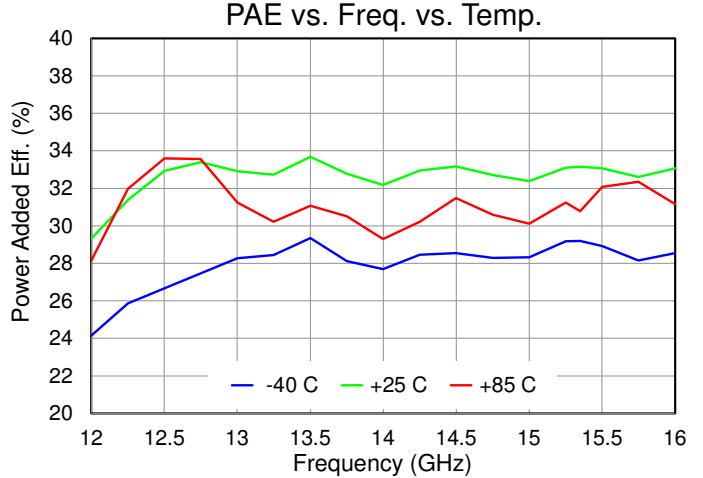
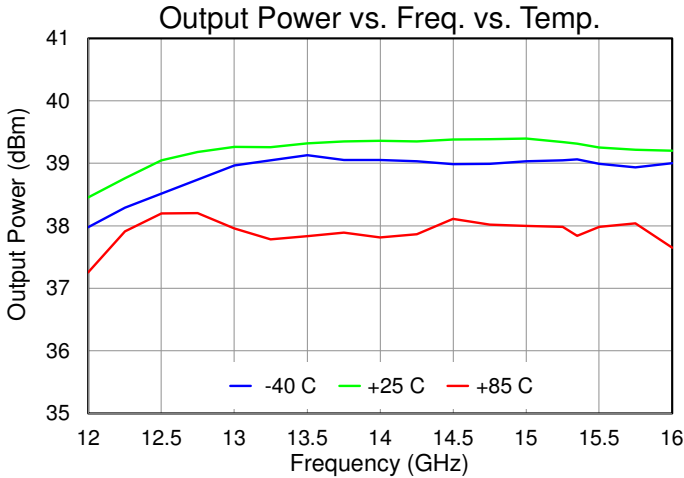

Performance Plots – Large Signal (CW)

Test conditions, unless otherwise noted: CW,  $V_D = 24\text{ V}$ ,  $I_{DQ} = 195\text{ mA}$  ( $I_{D12} = 131\text{ mA}$ ,  $I_{D3} = 64\text{ mA}$ ),  $P_{IN} = 10\text{ dBm}$ ,  $T_{BASE} = +25\text{ }^\circ\text{C}$  ( $T_{BASE}$  is backside of QPA0015).

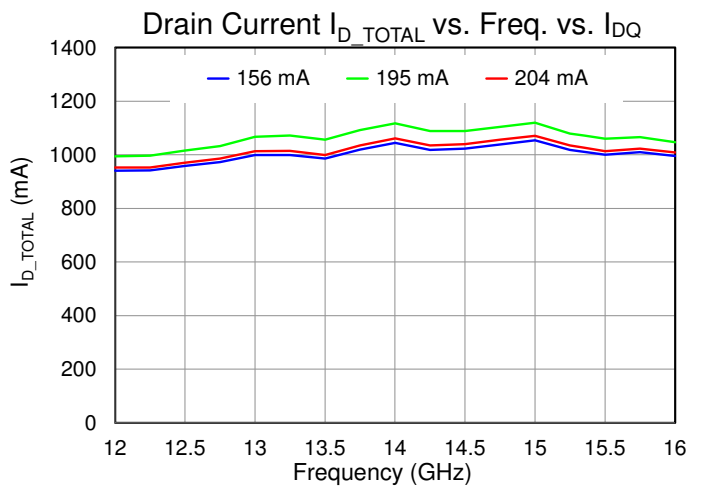
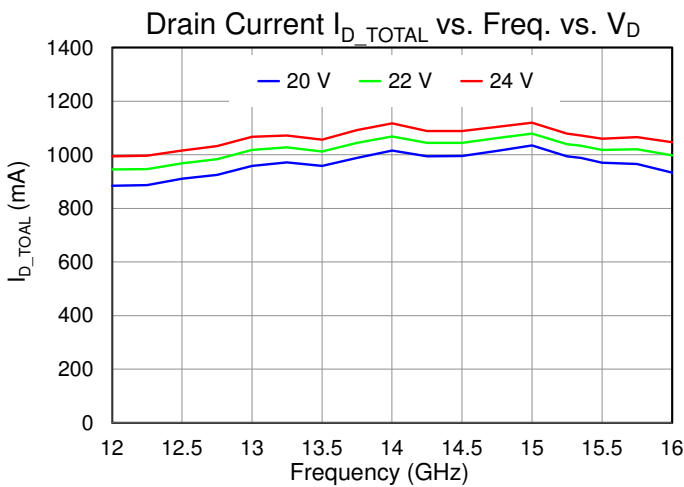
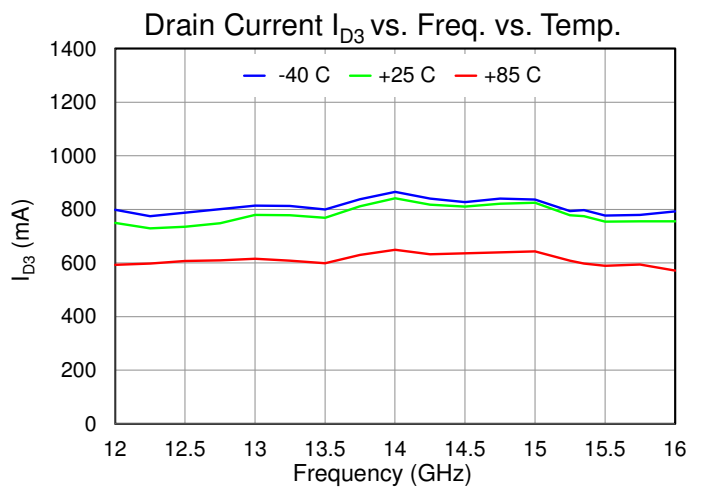
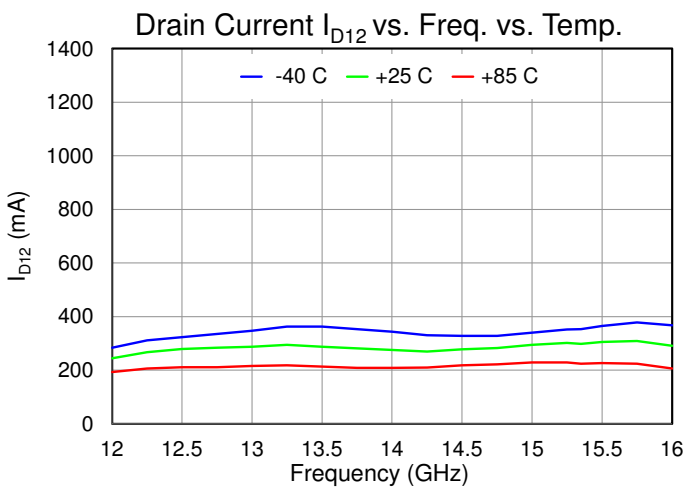
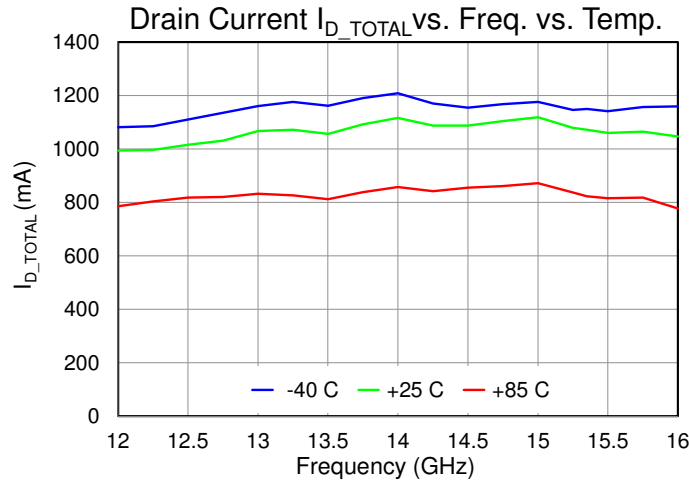

Performance Plots – Large Signal (CW)

Test conditions, unless otherwise noted: CW,  $V_D = 24\text{ V}$ ,  $I_{DQ} = 195\text{ mA}$  ( $I_{D12} = 131\text{ mA}$ ,  $I_{D3} = 64\text{ mA}$ ),  $P_{IN} = 10\text{ dBm}$ ,  $T_{BASE} = +25\text{ }^\circ\text{C}$  ( $T_{BASE}$  is backside of QPA0015).

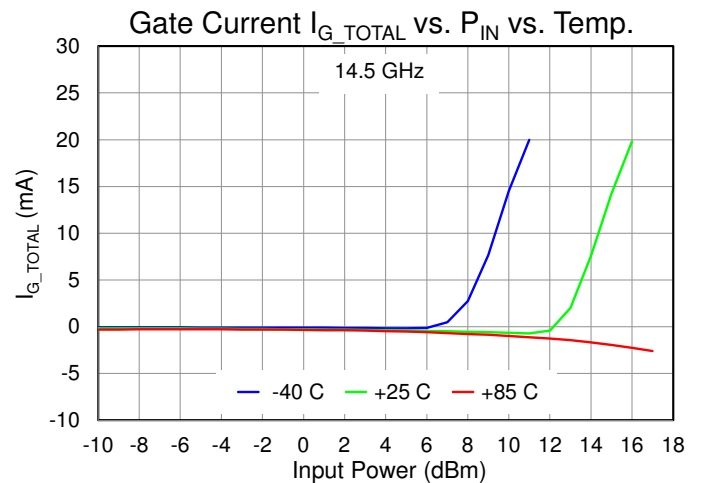
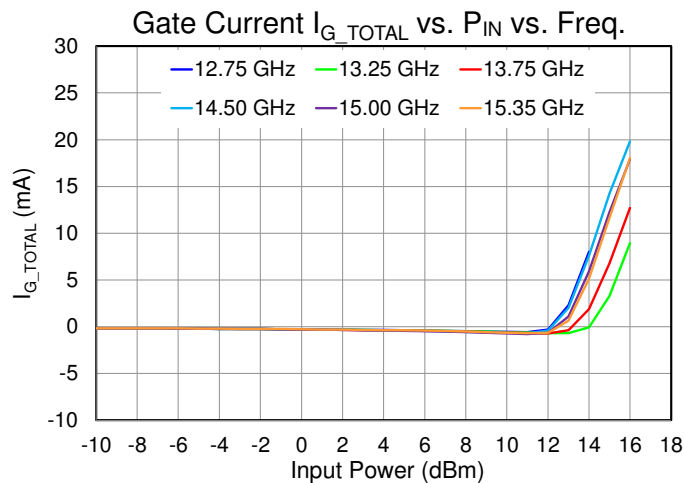
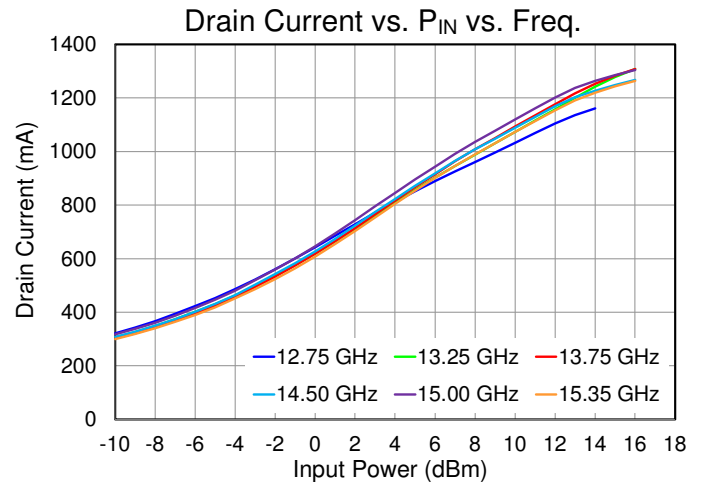
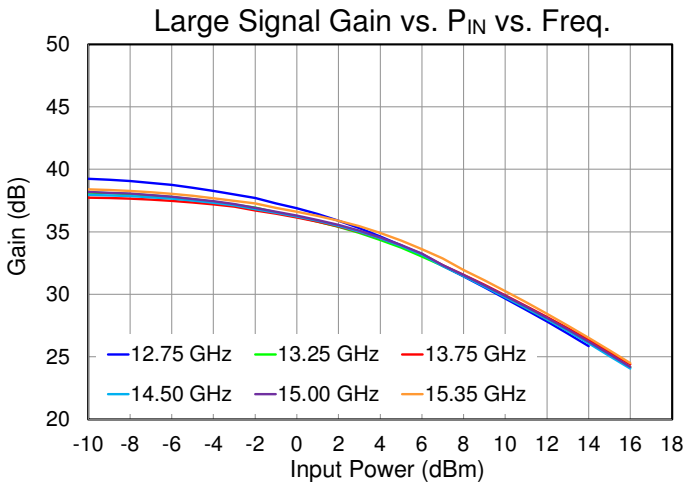
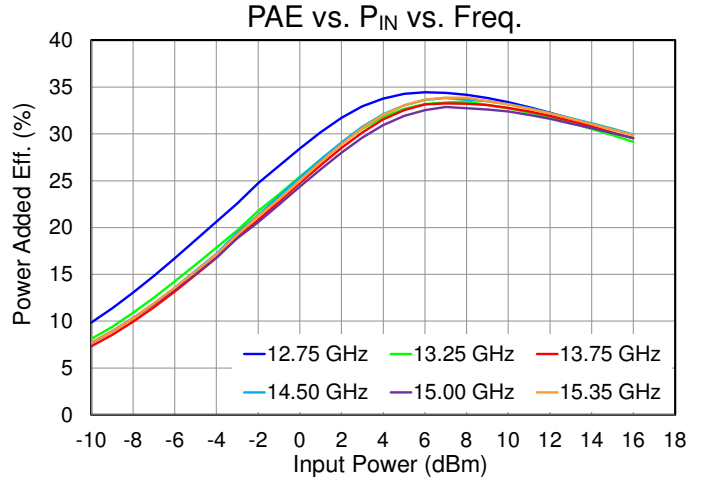
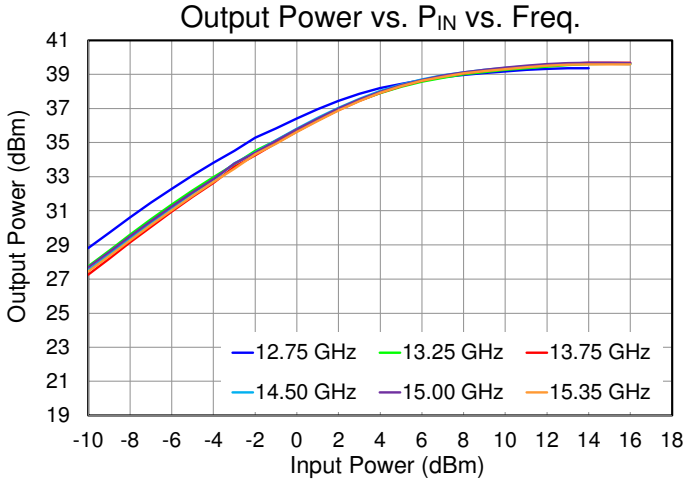

Performance Plots – Large Signal (CW)

Test conditions, unless otherwise noted: CW,  $V_D = 24\text{ V}$ ,  $I_{DQ} = 195\text{ mA}$  ( $I_{D12} = 131\text{ mA}$ ,  $I_{D3} = 64\text{ mA}$ ),  $P_{IN} = 10\text{ dBm}$ ,  $T_{BASE} = +25\text{ }^\circ\text{C}$  ( $T_{BASE}$  is backside of QPA0015).

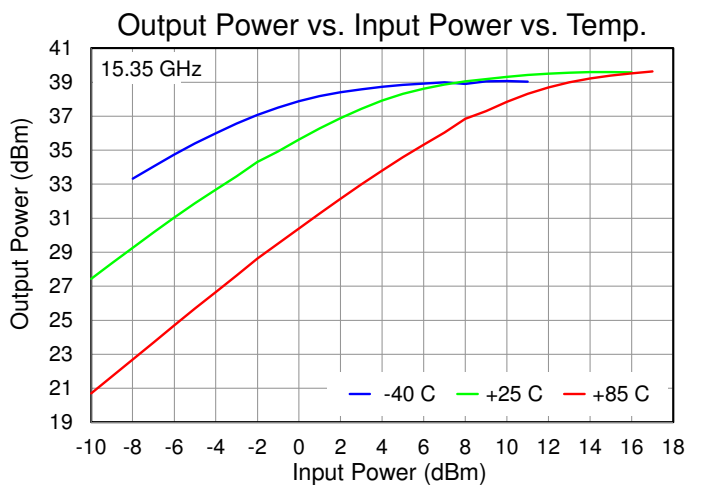
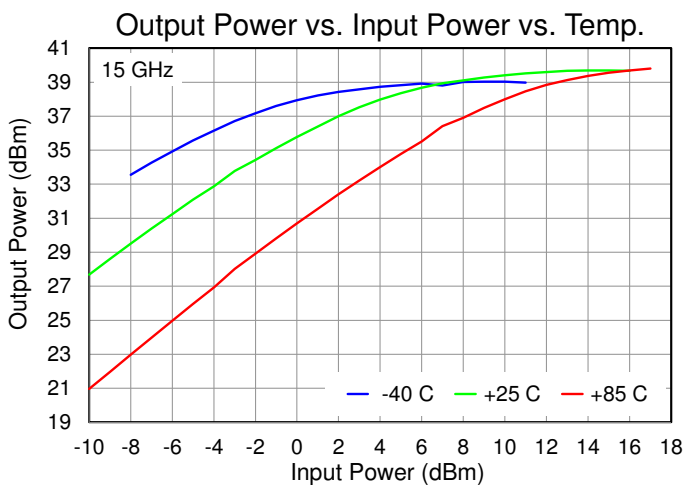
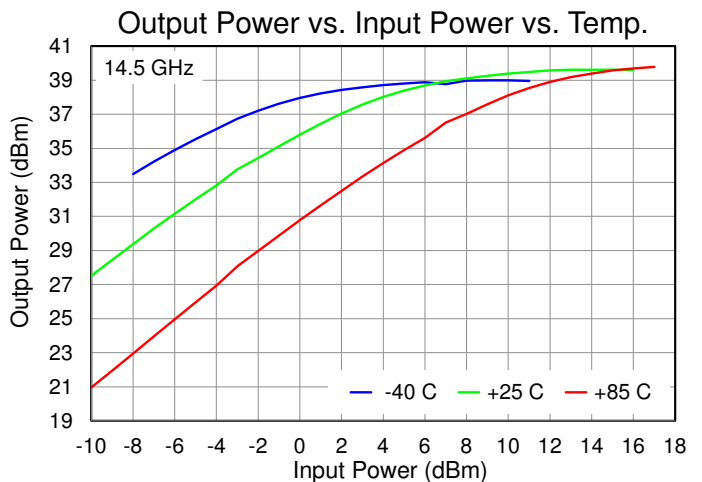
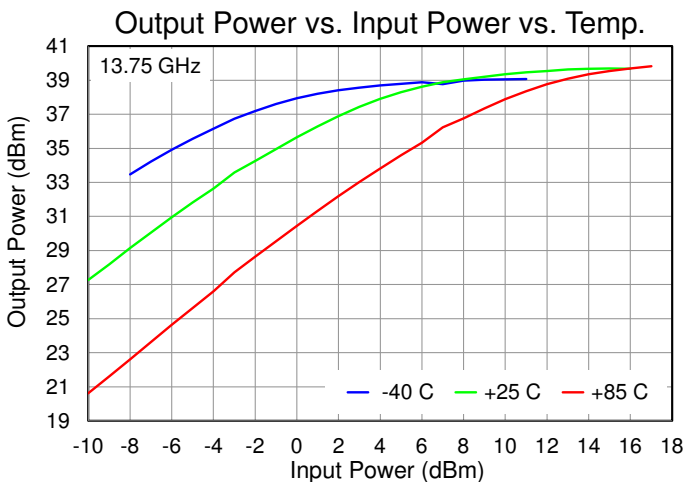
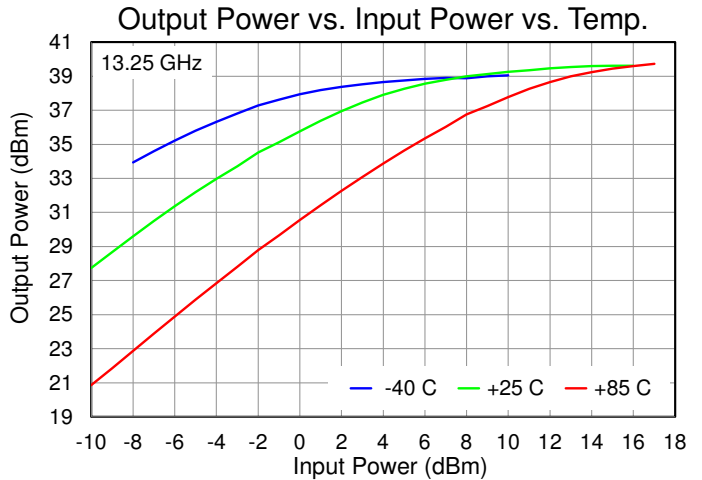
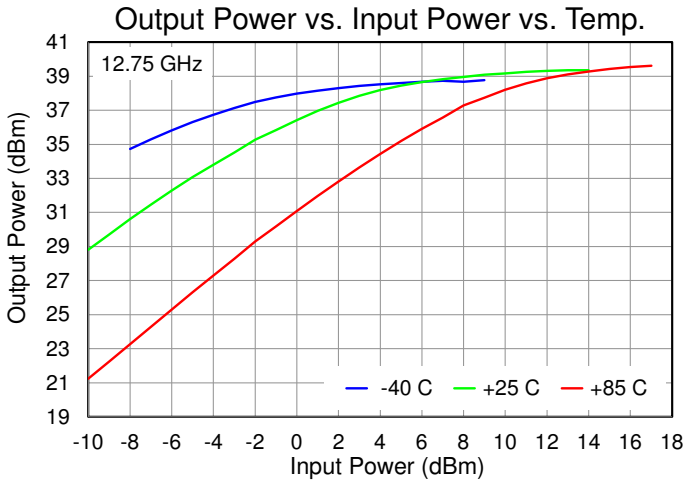

Performance Plots – Large Signal (CW)

Test conditions, unless otherwise noted: CW,  $V_D = 24\text{ V}$ ,  $I_{DQ} = 195\text{ mA}$  ( $I_{D12} = 131\text{ mA}$ ,  $I_{D3} = 64\text{ mA}$ ),  $P_{IN} = 10\text{ dBm}$ ,  $T_{BASE} = +25\text{ }^\circ\text{C}$  ( $T_{BASE}$  is backside of QPA0015).

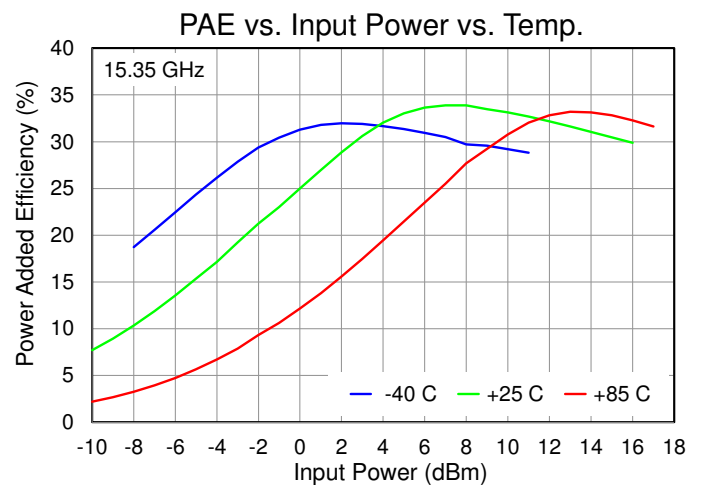
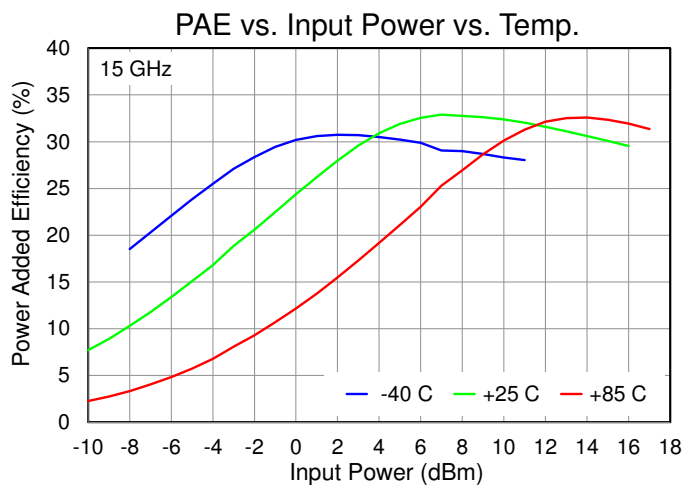
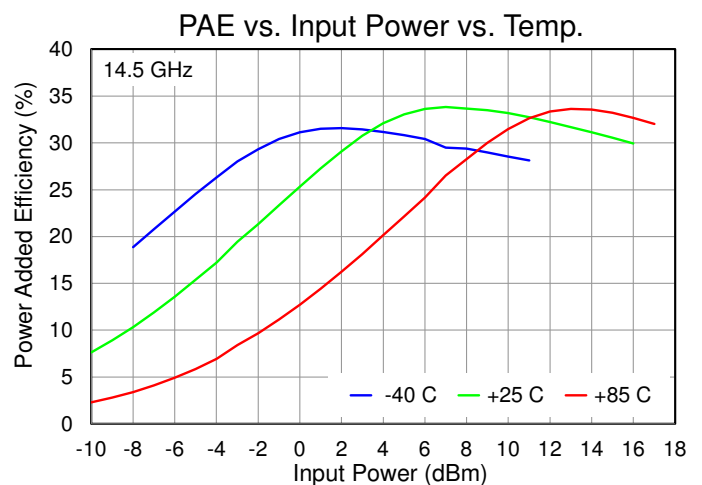
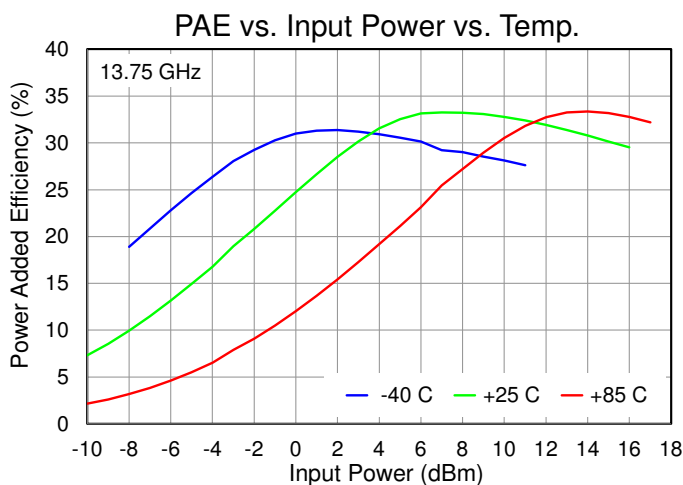
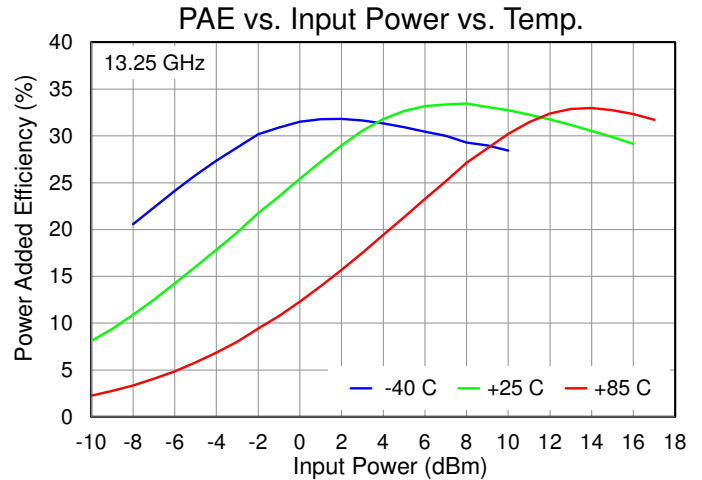
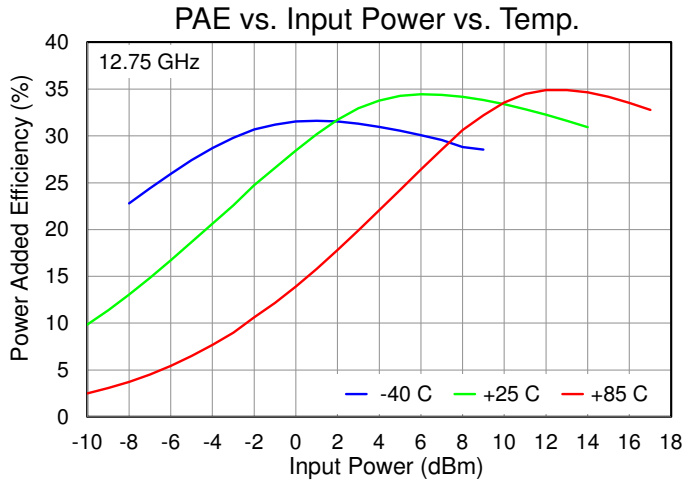

Performance Plots – Large Signal (CW)

Test conditions, unless otherwise noted: CW,  $V_D = 24\text{ V}$ ,  $I_{DQ} = 195\text{ mA}$  ( $I_{D12} = 131\text{ mA}$ ,  $I_{D3} = 64\text{ mA}$ ),  $P_{IN} = 10\text{ dBm}$ ,  $T_{BASE} = +25\text{ }^\circ\text{C}$  ( $T_{BASE}$  is backside of QPA0015).

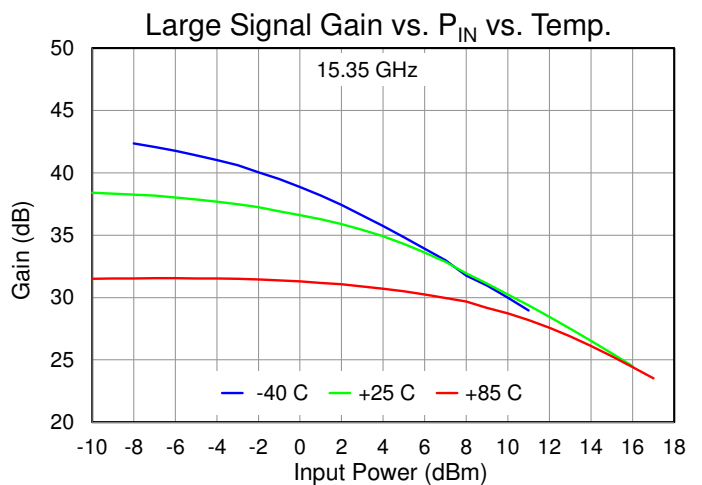
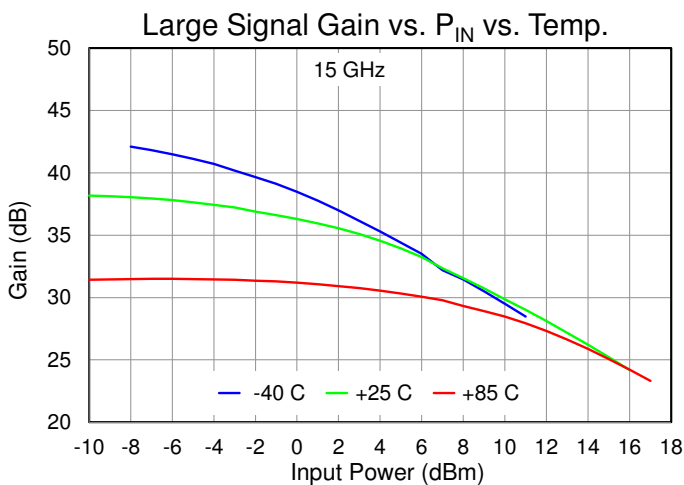
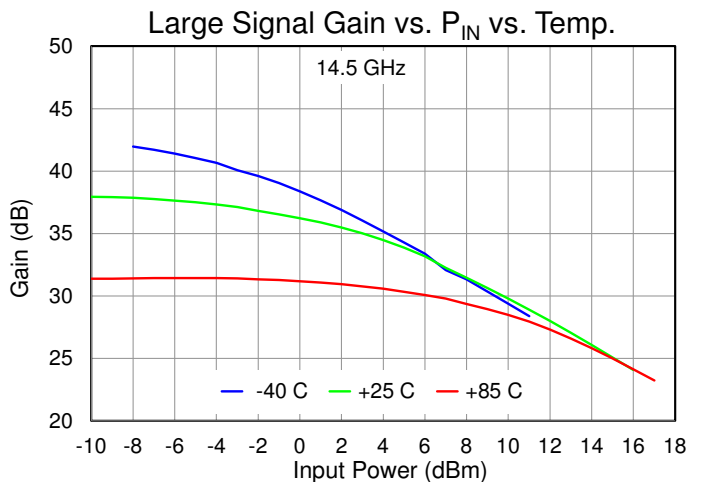
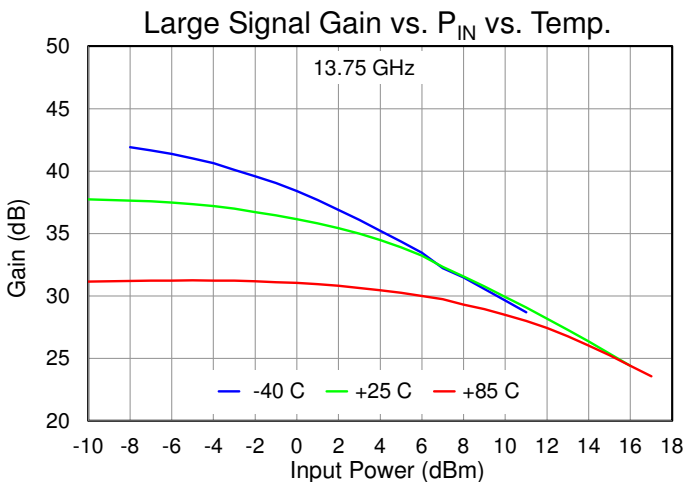
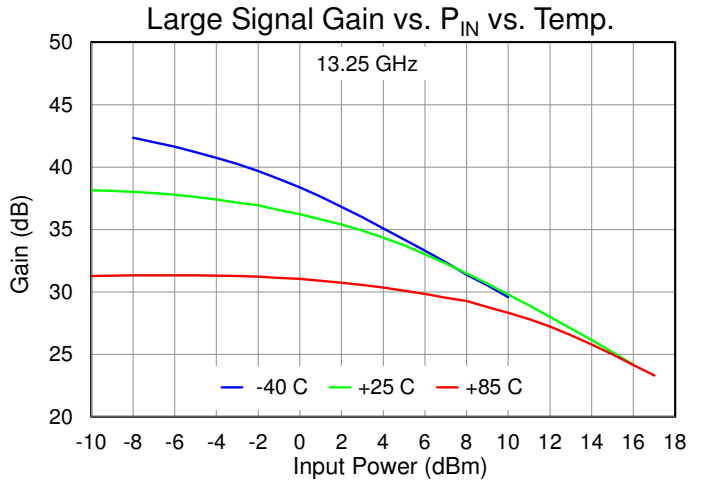
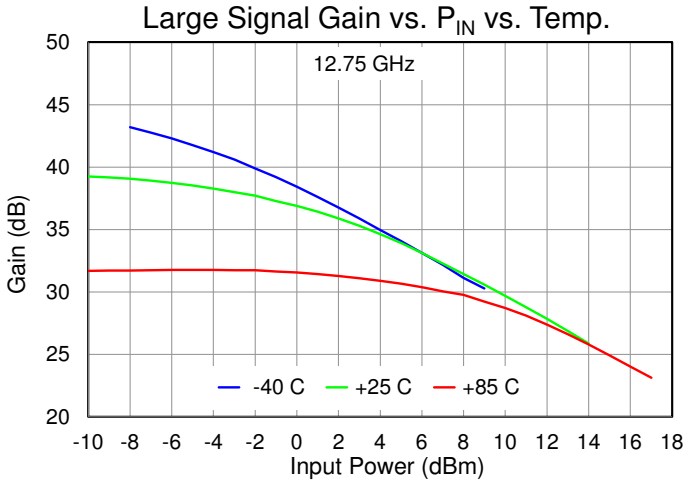

Performance Plots – Large Signal (CW)

Test conditions, unless otherwise noted: CW,  $V_D = 24\text{ V}$ ,  $I_{DQ} = 195\text{ mA}$  ( $I_{D12} = 131\text{ mA}$ ,  $I_{D3} = 64\text{ mA}$ ),  $P_{IN} = 10\text{ dBm}$ ,  $T_{BASE} = +25\text{ }^\circ\text{C}$  ( $T_{BASE}$  is backside of QPA0015).

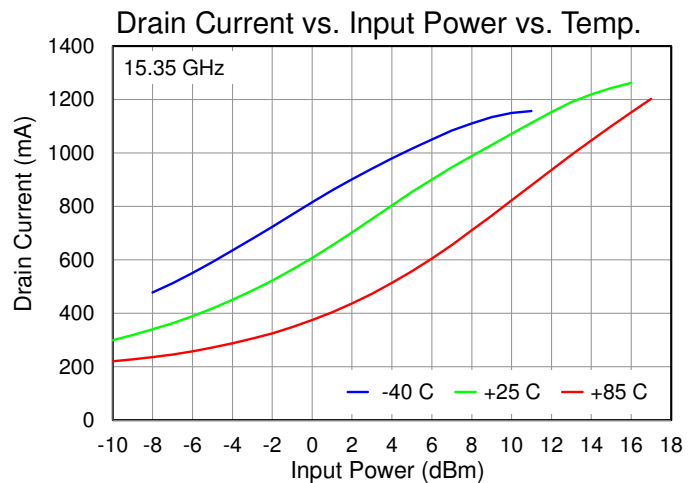
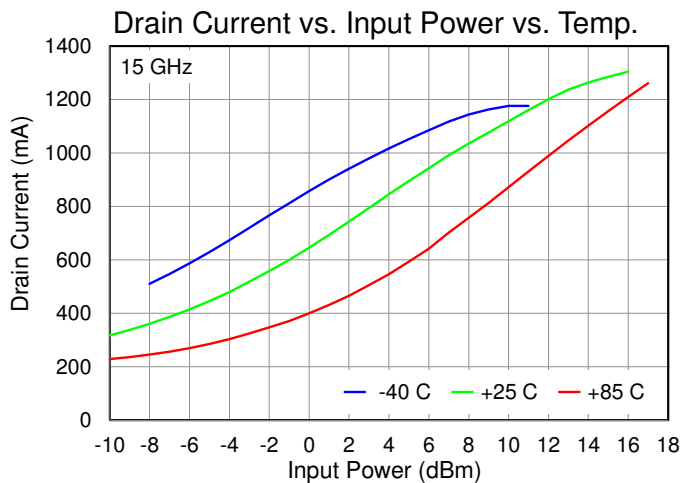
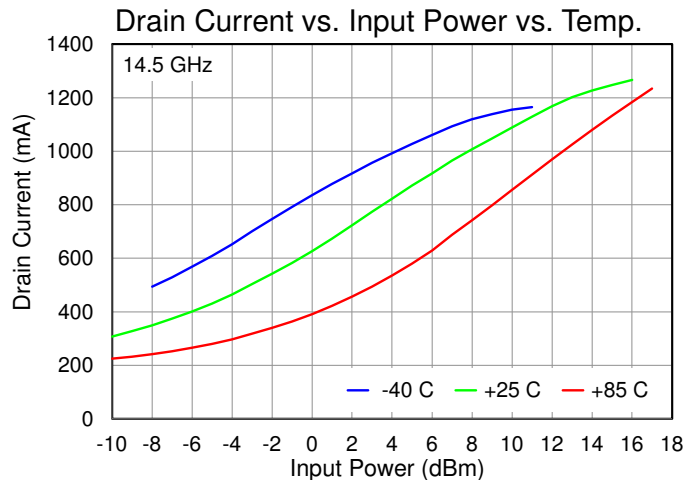
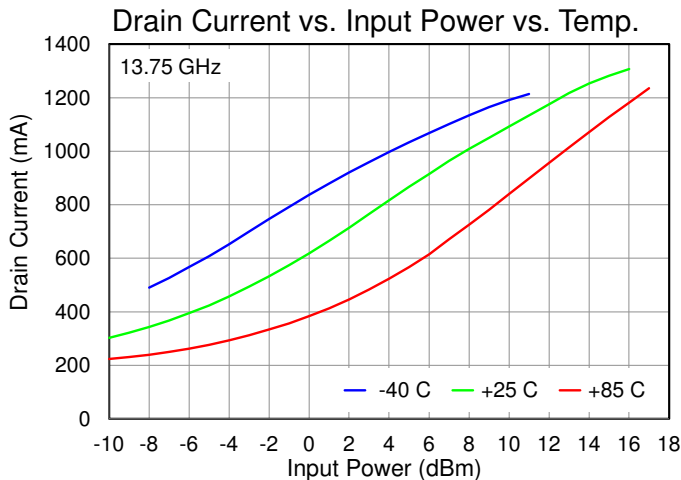
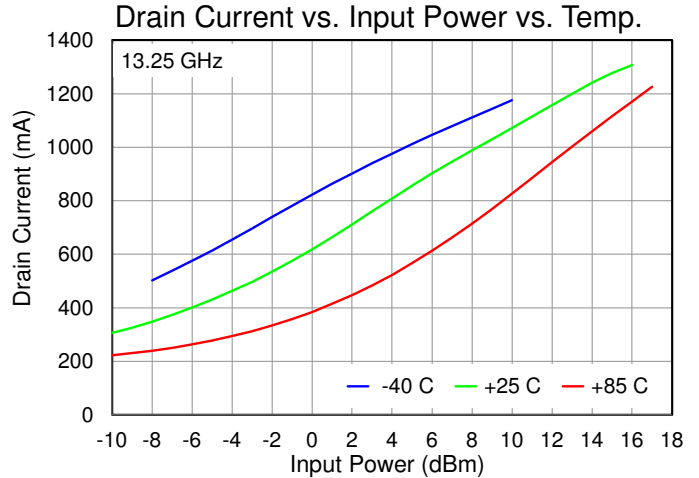
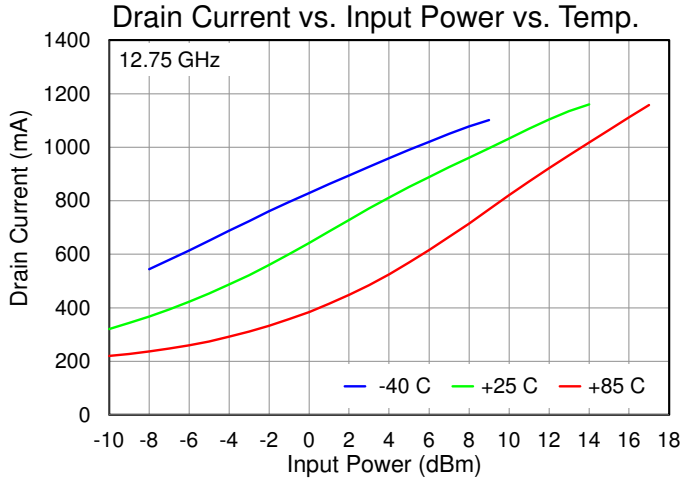

Performance Plots – Large Signal (CW)

Test conditions, unless otherwise noted: CW,  $V_D = 24\text{ V}$ ,  $I_{DQ} = 195\text{ mA}$  ( $I_{D12} = 131\text{ mA}$ ,  $I_{D3} = 64\text{ mA}$ ),  $P_{IN} = 10\text{ dBm}$ ,  $T_{BASE} = +25\text{ }^\circ\text{C}$  ( $T_{BASE}$  is backside of QPA0015).

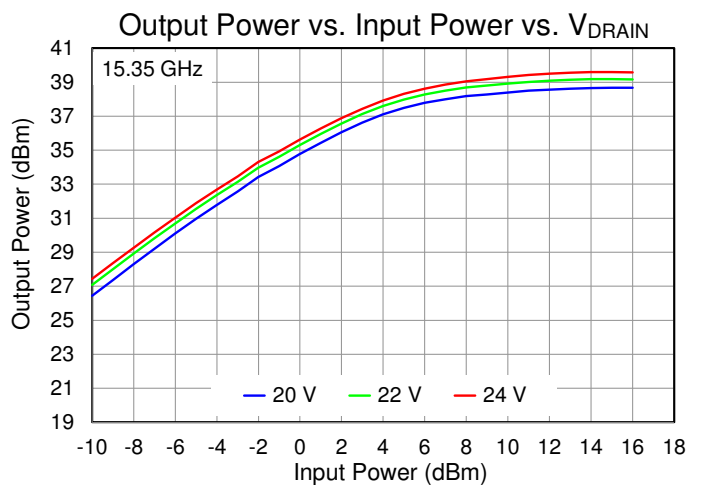
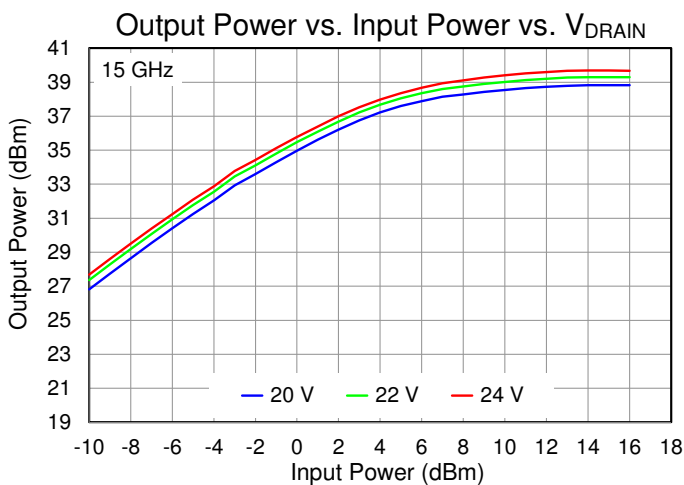
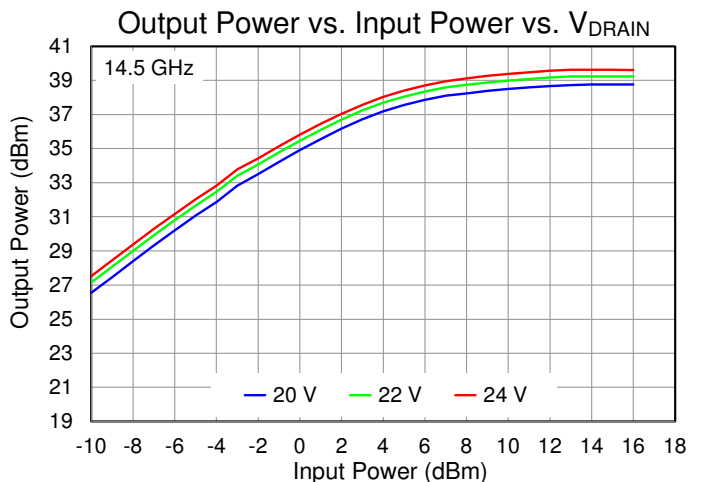
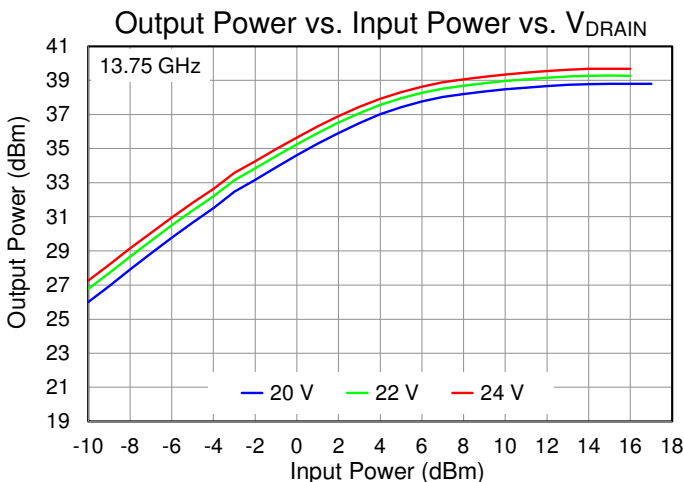
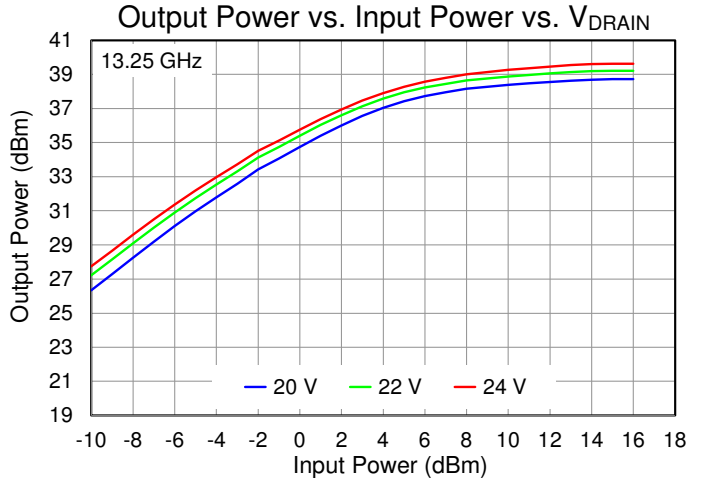
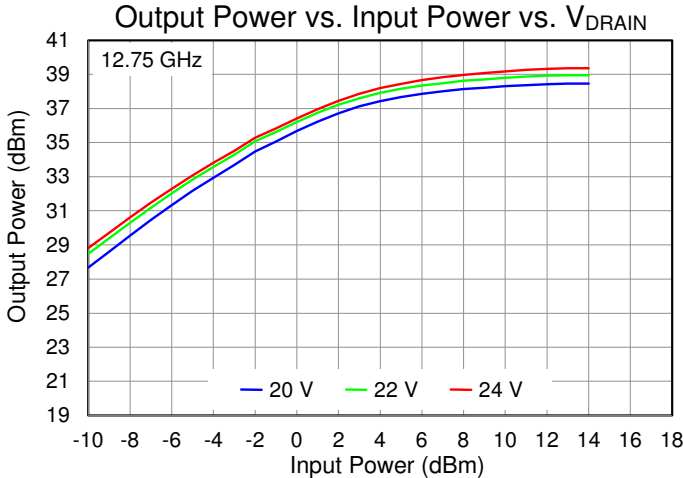

Performance Plots – Large Signal (CW)

Test conditions, unless otherwise noted: CW,  $V_D = 24\text{ V}$ ,  $I_{DQ} = 195\text{ mA}$  ( $I_{D12} = 131\text{ mA}$ ,  $I_{D3} = 64\text{ mA}$ ),  $P_{IN} = 10\text{ dBm}$ ,  $T_{BASE} = +25\text{ °C}$  ( $T_{BASE}$  is backside of QPA0015).

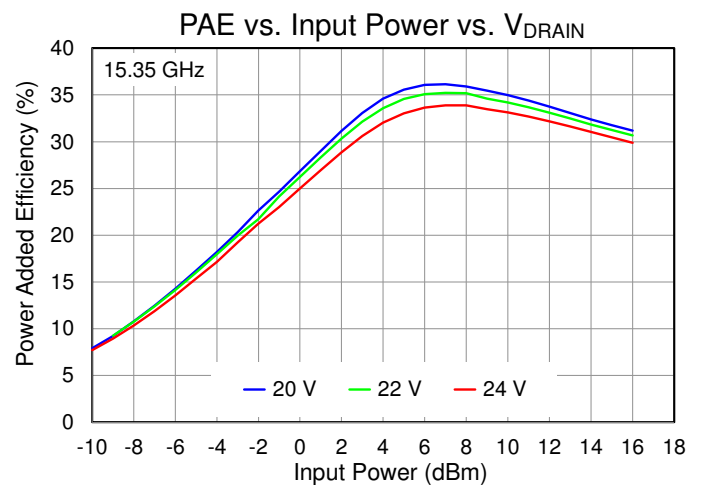
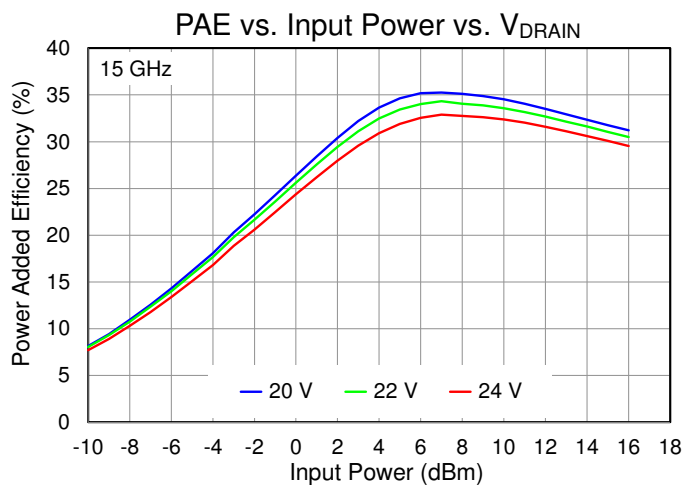
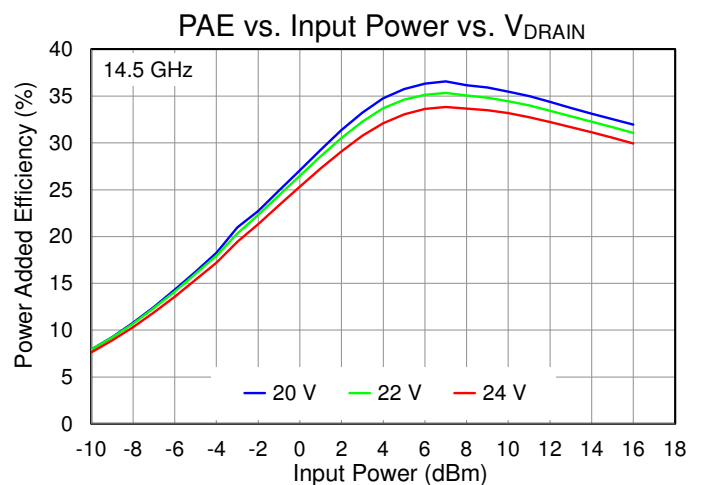
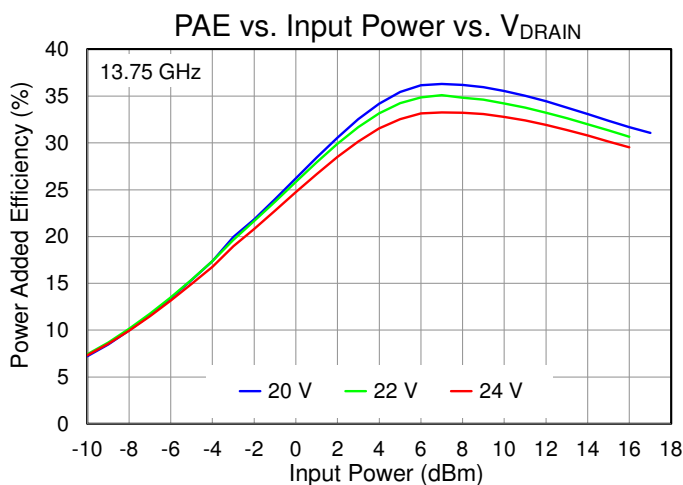
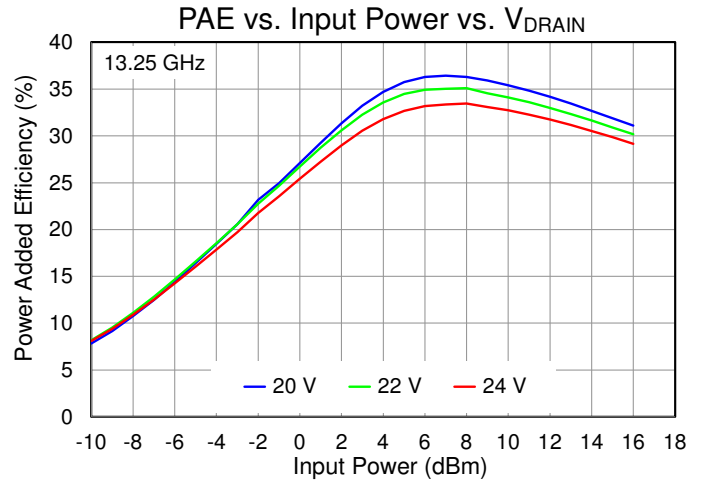
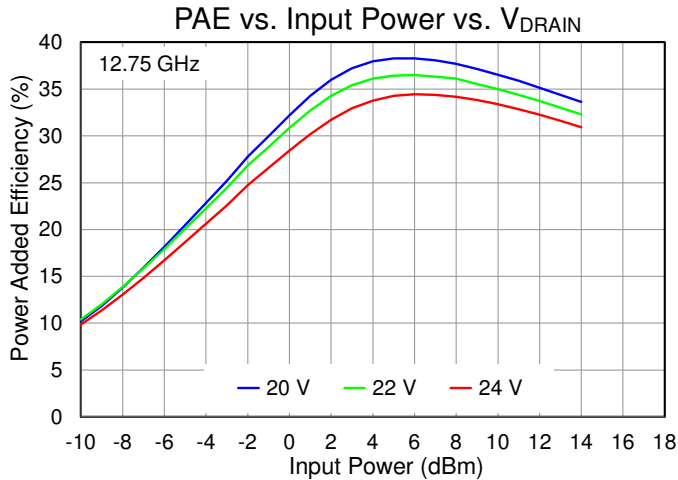

Performance Plots – Large Signal (CW)

Test conditions, unless otherwise noted: CW,  $V_D = 24\text{ V}$ ,  $I_{DQ} = 195\text{ mA}$  ( $I_{D12} = 131\text{ mA}$ ,  $I_{D3} = 64\text{ mA}$ ),  $P_{IN} = 10\text{ dBm}$ ,  $T_{BASE} = +25\text{ }^\circ\text{C}$  ( $T_{BASE}$  is backside of QPA0015).

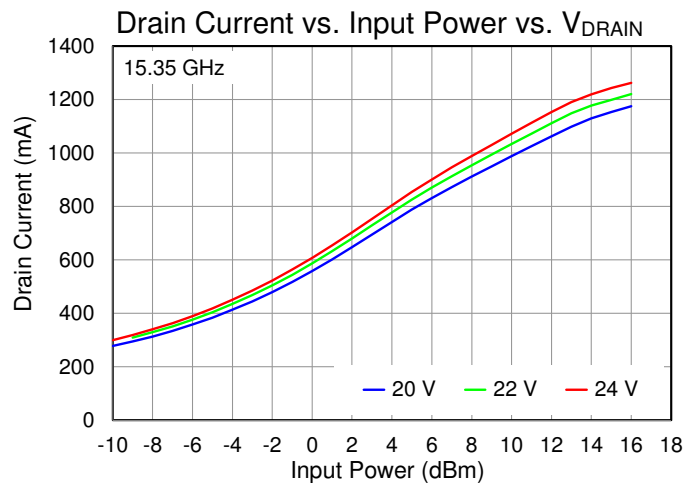
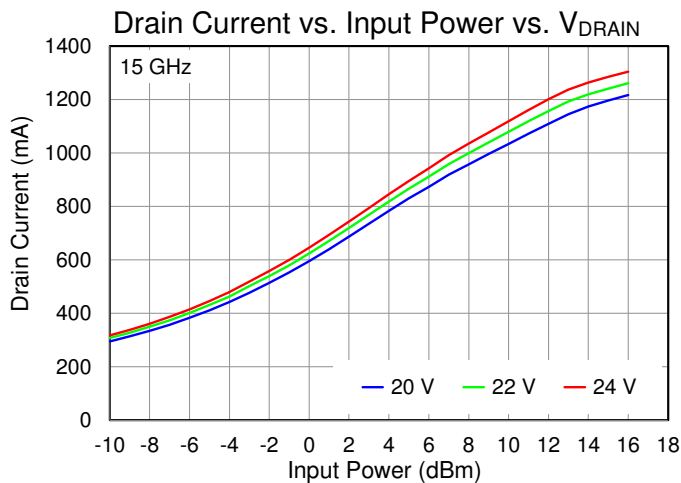
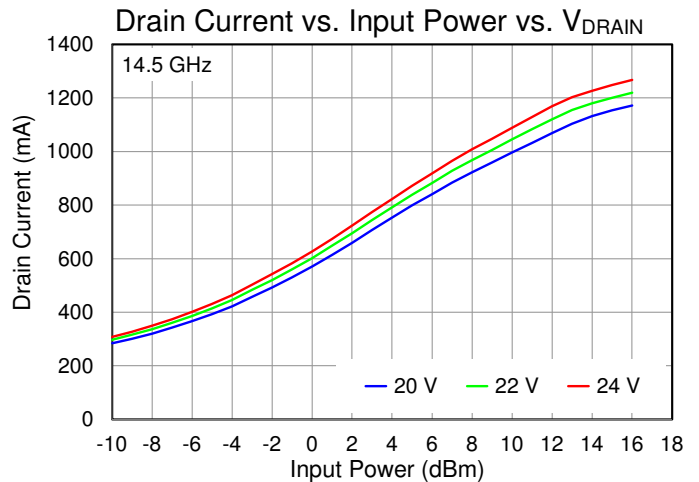
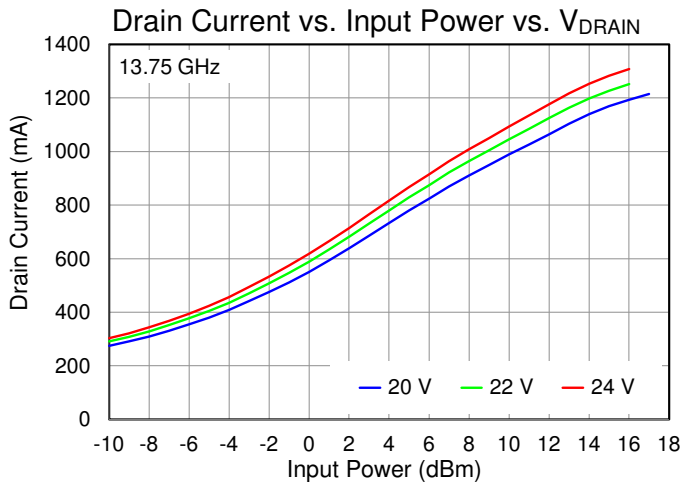
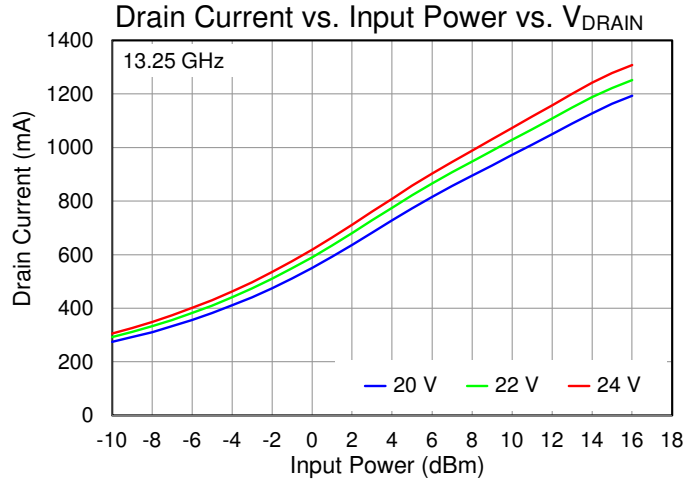
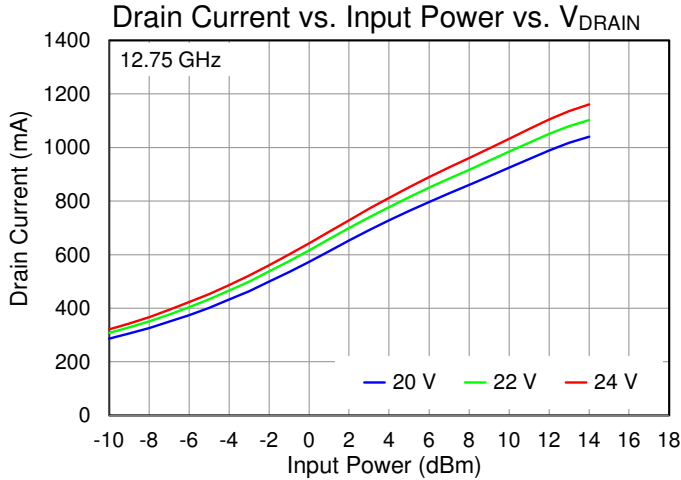

Performance Plots – Large Signal (CW)

Test conditions, unless otherwise noted: CW,  $V_D = 24\text{ V}$ ,  $I_{DQ} = 195\text{ mA}$  ( $I_{D12} = 131\text{ mA}$ ,  $I_{D3} = 64\text{ mA}$ ),  $P_{IN} = 10\text{ dBm}$ ,  $T_{BASE} = +25\text{ }^\circ\text{C}$  ( $T_{BASE}$  is backside of QPA0015).

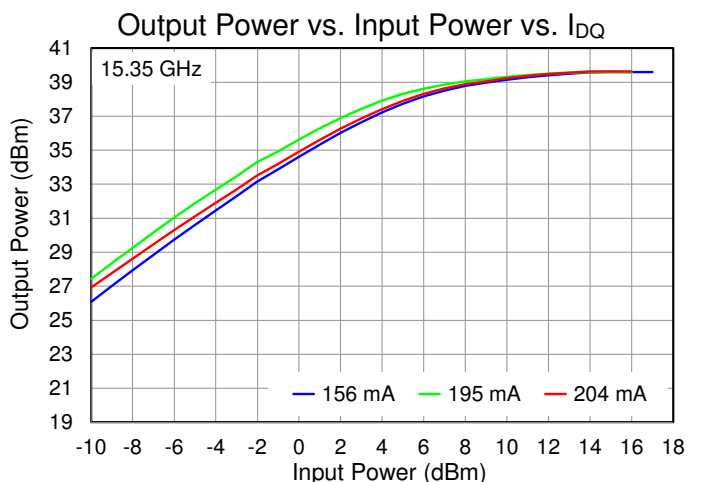
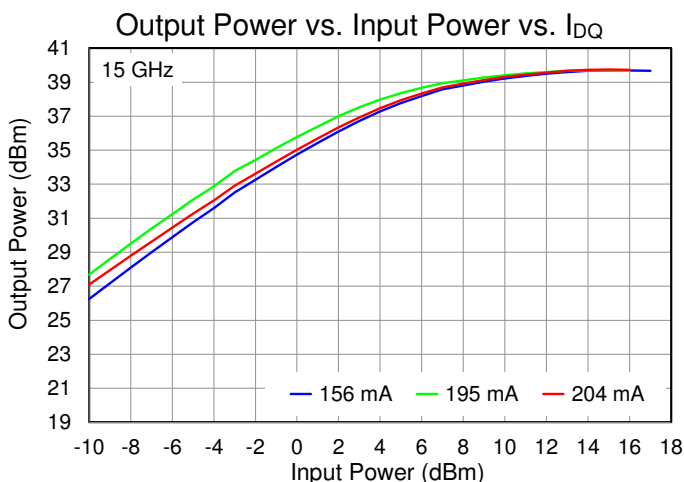
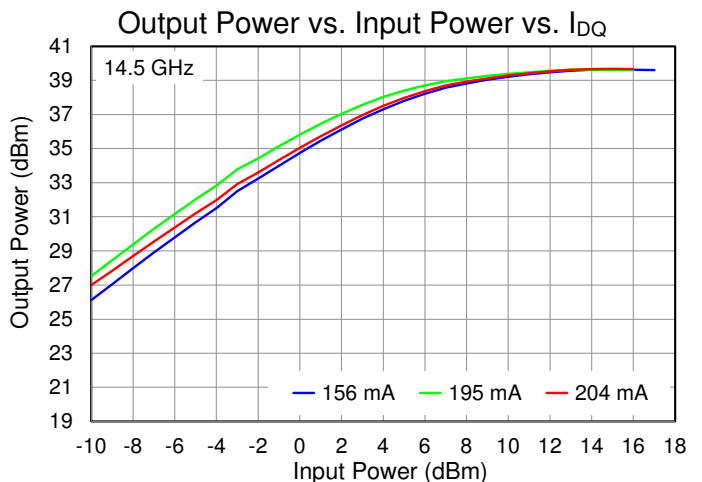
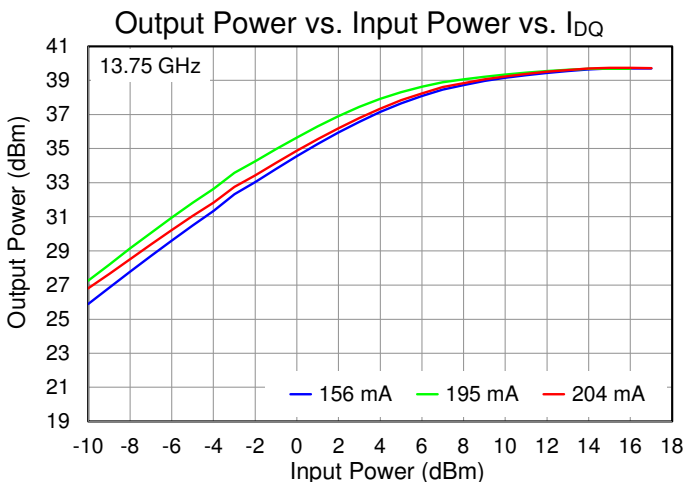
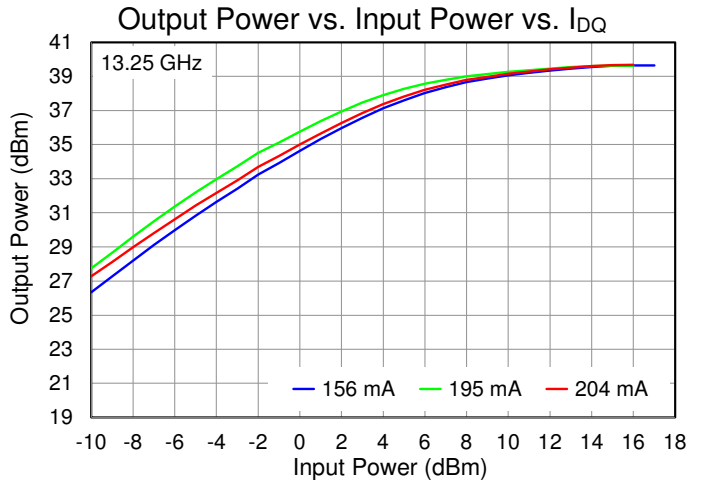
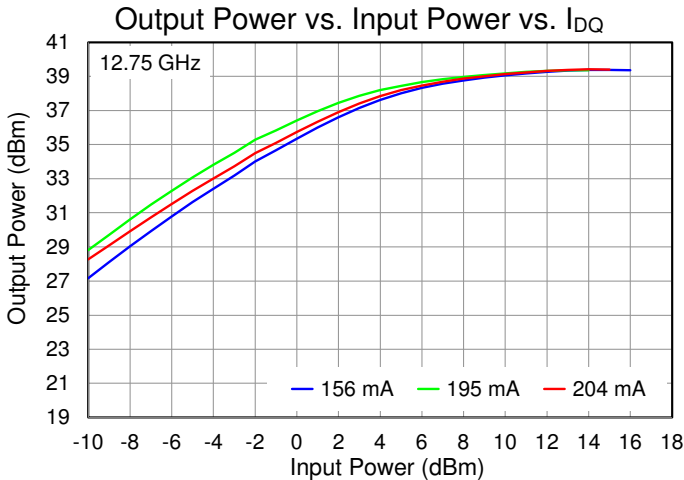

Performance Plots – Large Signal (CW)

Test conditions, unless otherwise noted: CW,  $V_D = 24\text{ V}$ ,  $I_{DQ} = 195\text{ mA}$  ( $I_{D12} = 131\text{ mA}$ ,  $I_{D3} = 64\text{ mA}$ ),  $P_{IN} = 10\text{ dBm}$ ,  $T_{BASE} = +25\text{ }^\circ\text{C}$  ( $T_{BASE}$  is backside of QPA0015).

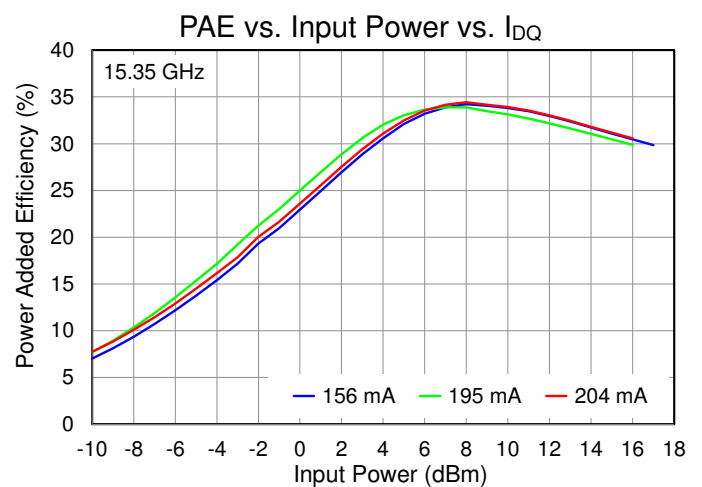
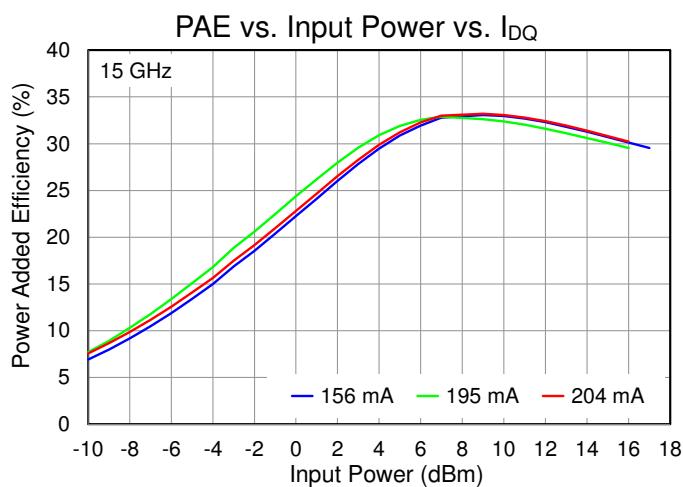
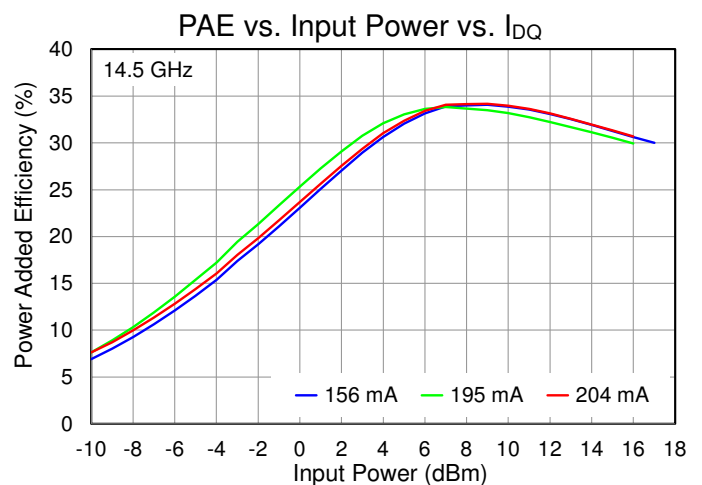
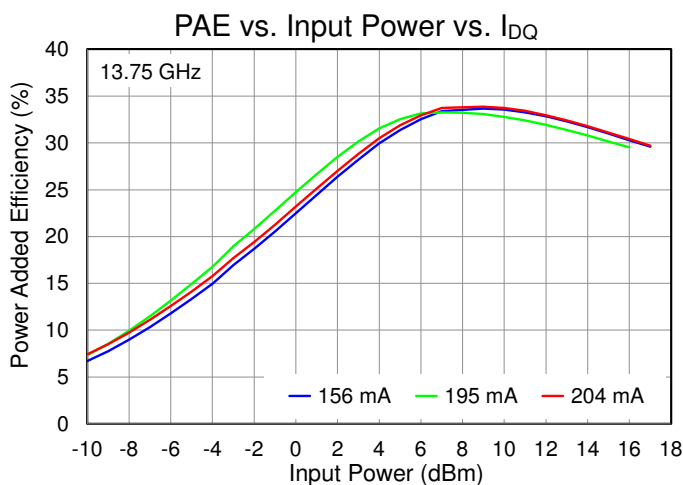
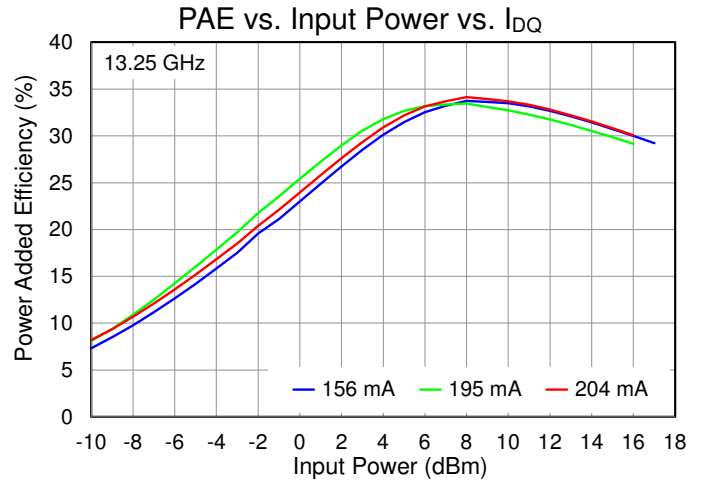
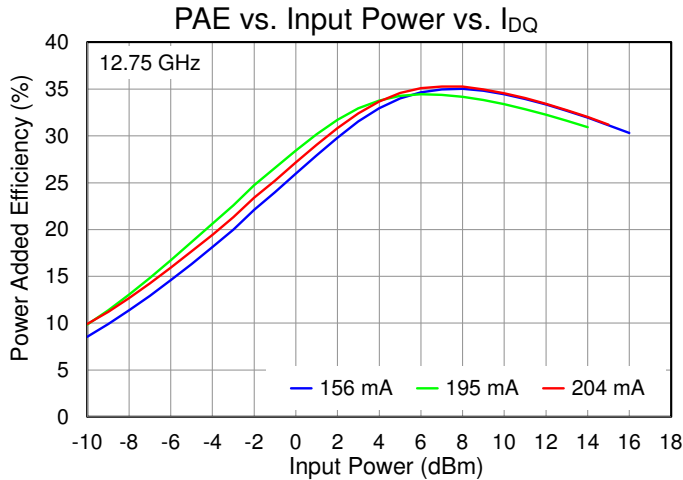

Performance Plots – Large Signal (CW)

Test conditions, unless otherwise noted: CW,  $V_D = 24\text{ V}$ ,  $I_{DQ} = 195\text{ mA}$  ( $I_{D12} = 131\text{ mA}$ ,  $I_{D3} = 64\text{ mA}$ ),  $P_{IN} = 10\text{ dBm}$ ,  $T_{BASE} = +25\text{ }^\circ\text{C}$  ( $T_{BASE}$  is backside of QPA0015).

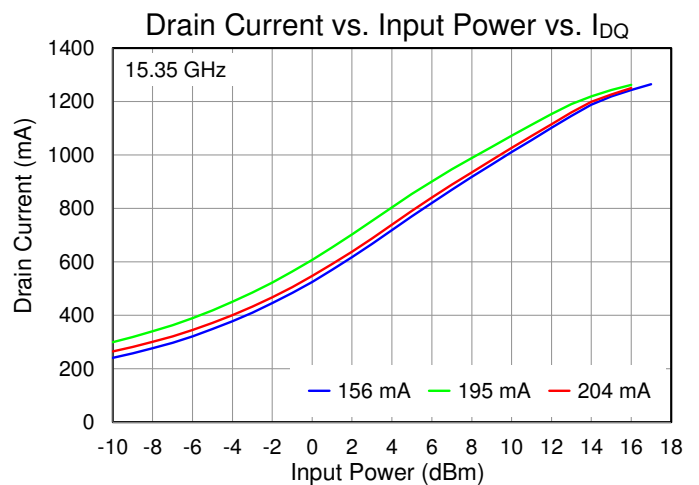
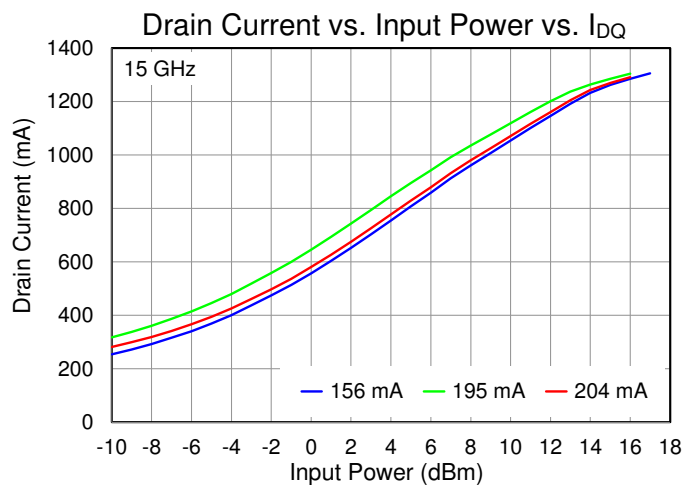
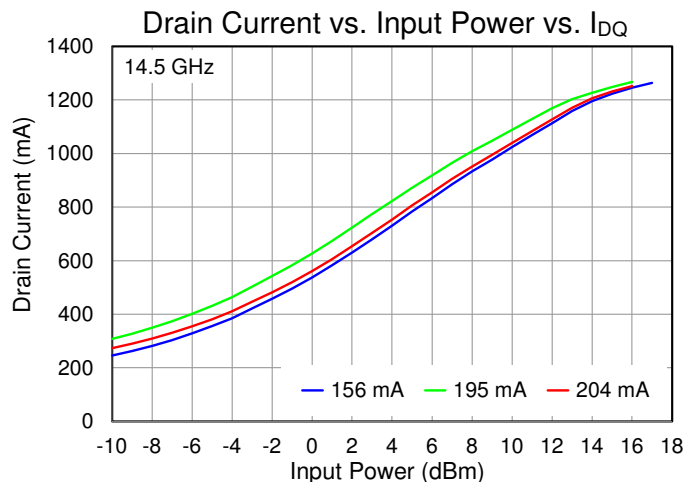
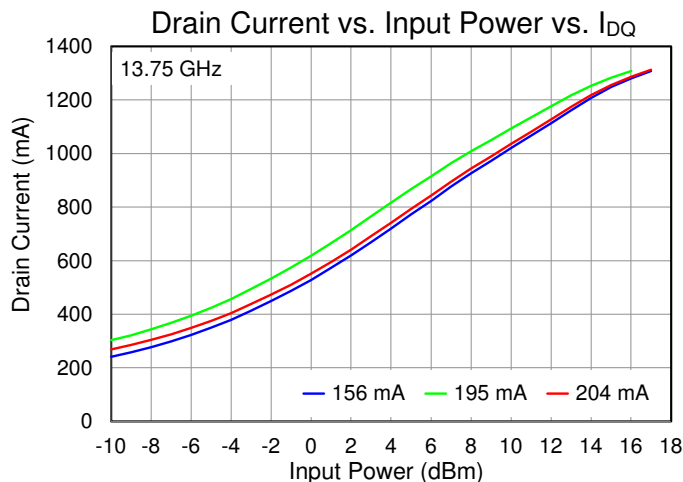
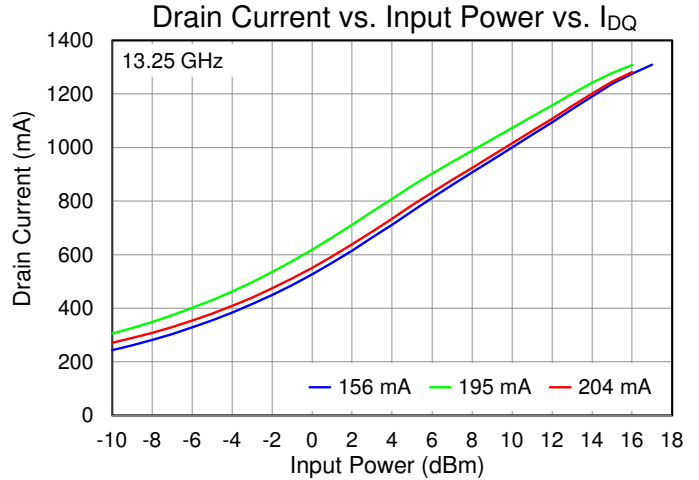
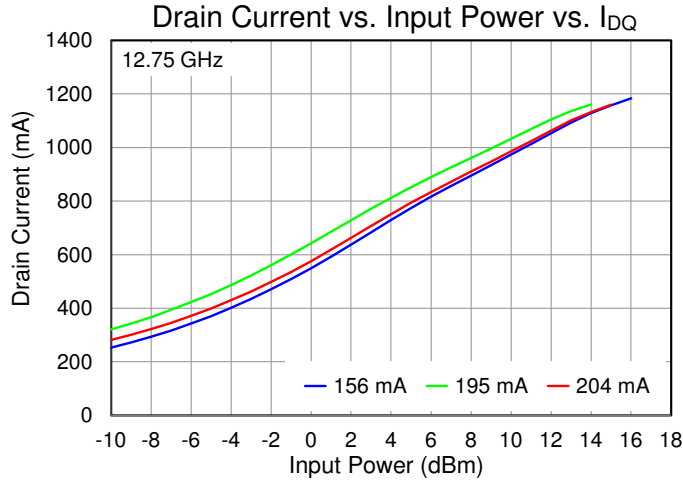

Performance Plots – Harmonics (CW)

Test conditions, unless otherwise noted: CW,  $V_D = 24\text{ V}$ ,  $I_{DQ} = 195\text{ mA}$  ( $I_{D12} = 131\text{ mA}$ ,  $I_{D3} = 64\text{ mA}$ ),  $T_{BASE} = +25\text{ }^\circ\text{C}$  ( $T_{BASE}$  is backside of QPA0015).

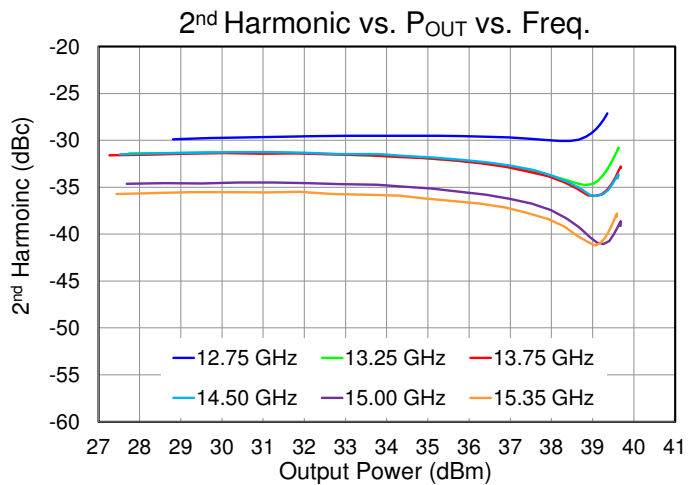
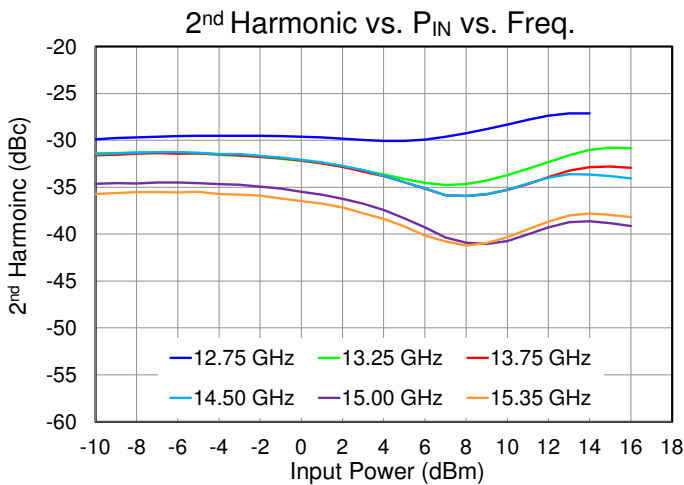
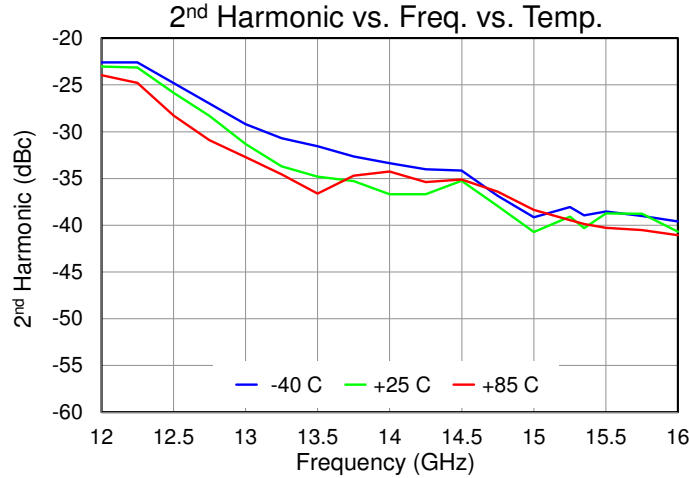

Performance Plots – Linearity (CW)

Test conditions, unless otherwise noted: CW,  $V_D = 24\text{ V}$ ,  $I_{DQ} = 195\text{ mA}$  ( $I_{D12} = 131\text{ mA}$ ,  $I_{D3} = 64\text{ mA}$ ), Tone Spacing = 20 MHz,  $T_{BASE} = +25\text{ }^\circ\text{C}$  ( $T_{BASE}$  is backside of QPA0015).

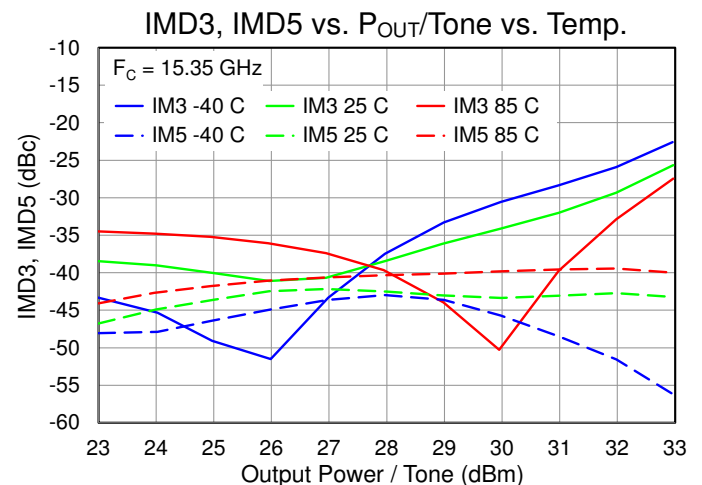
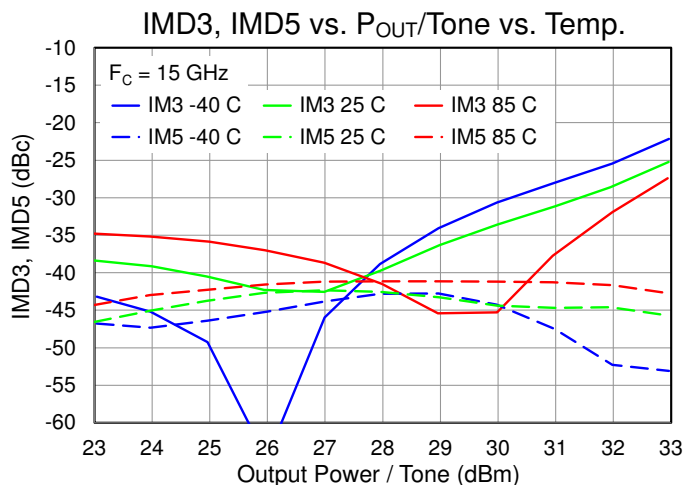
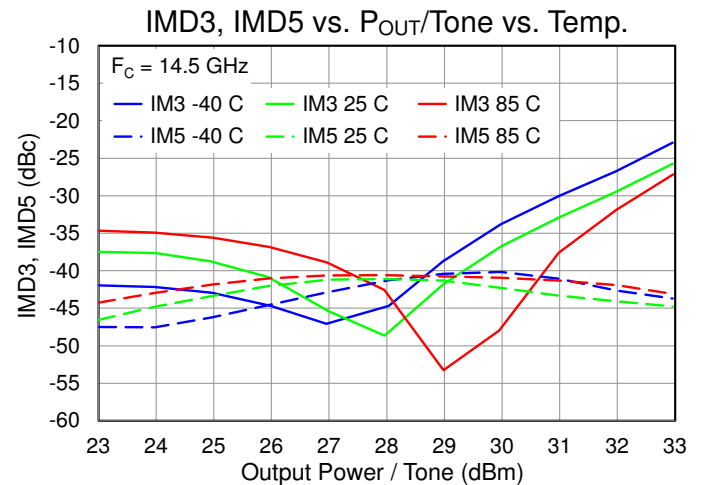
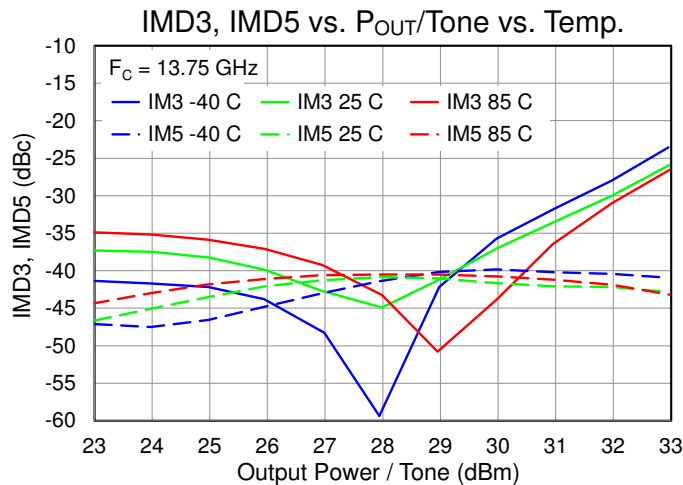
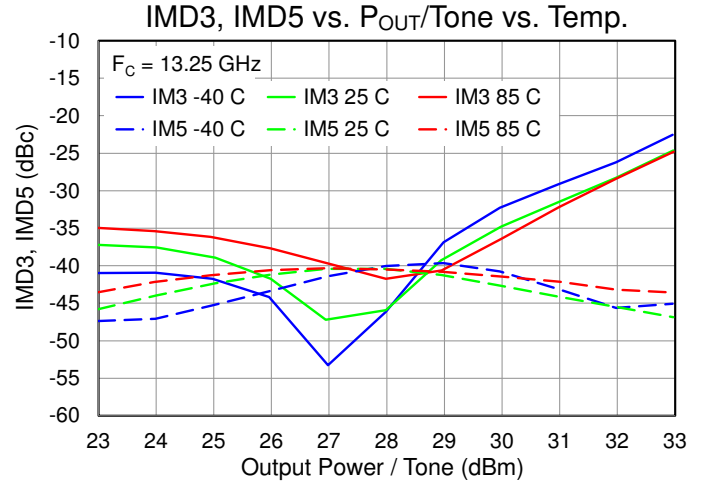
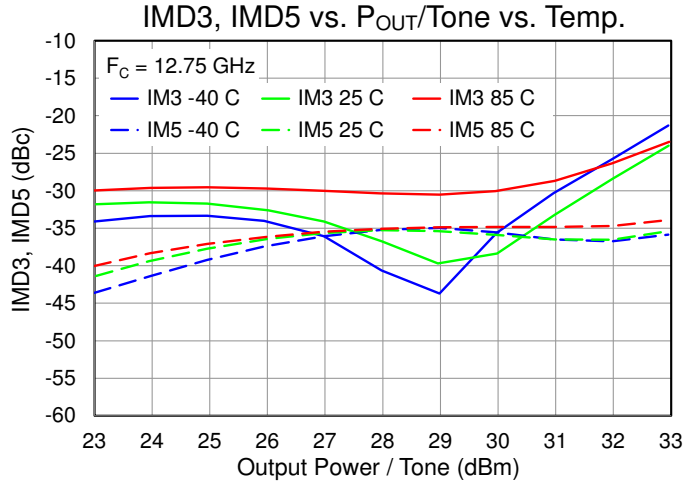

Performance Plots – Linearity (CW)

Test conditions, unless otherwise noted: CW,  $V_D = 24\text{ V}$ ,  $I_{DQ} = 195\text{ mA}$  ( $I_{D12} = 131\text{ mA}$ ,  $I_{D3} = 64\text{ mA}$ ), Tone Spacing = 20 MHz,  $T_{BASE} = +25\text{ }^\circ\text{C}$  ( $T_{BASE}$  is backside of QPA0015).

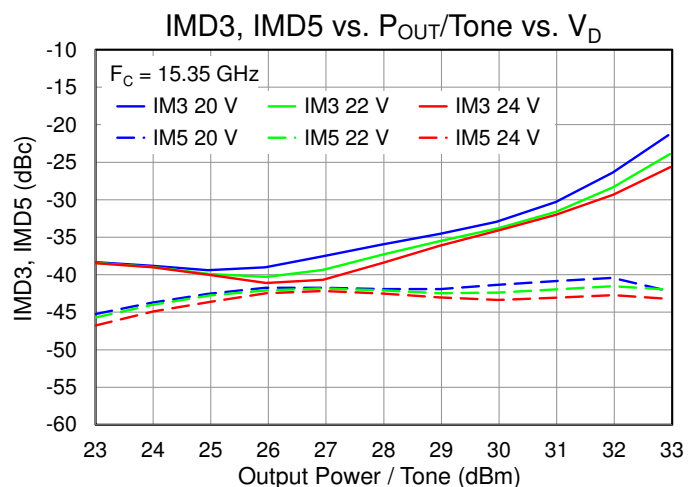
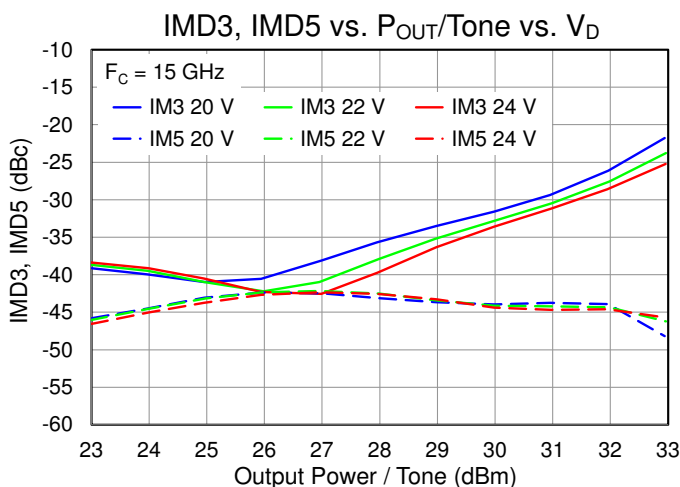
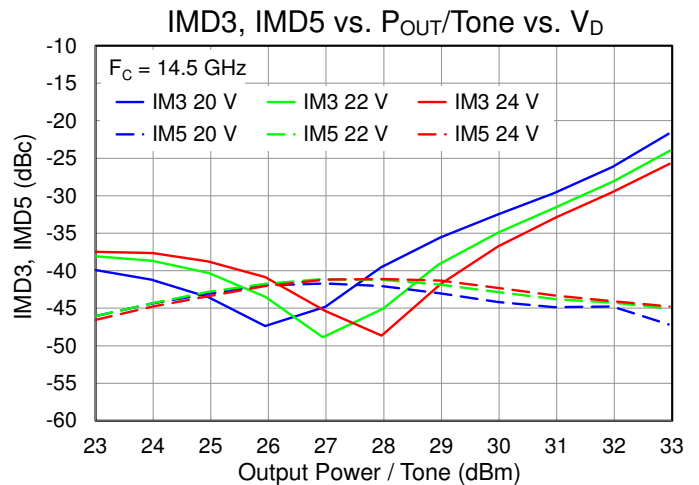
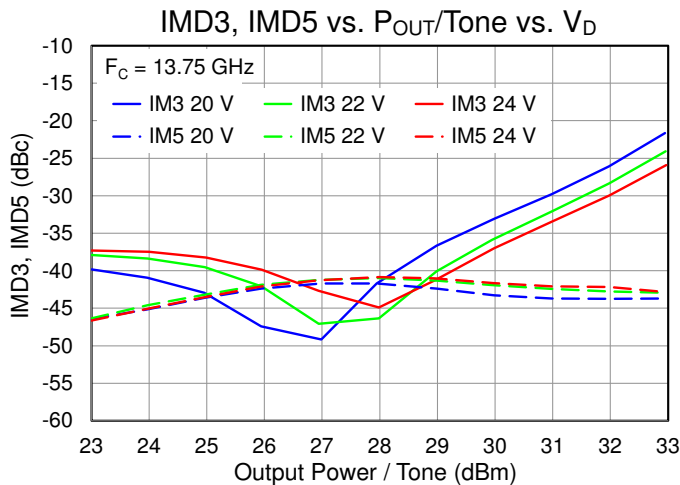
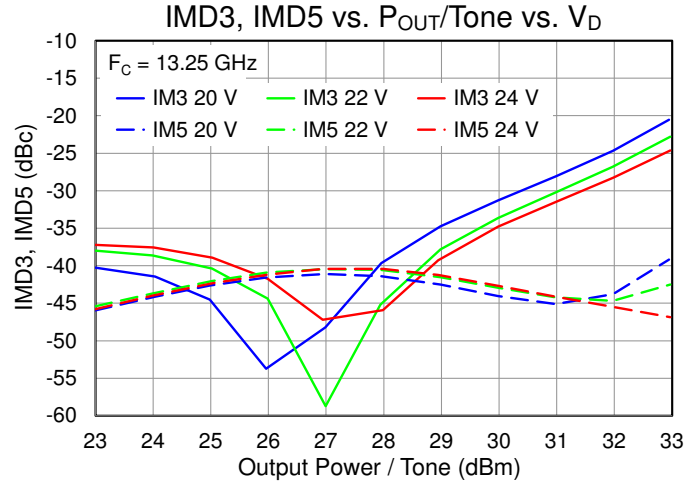
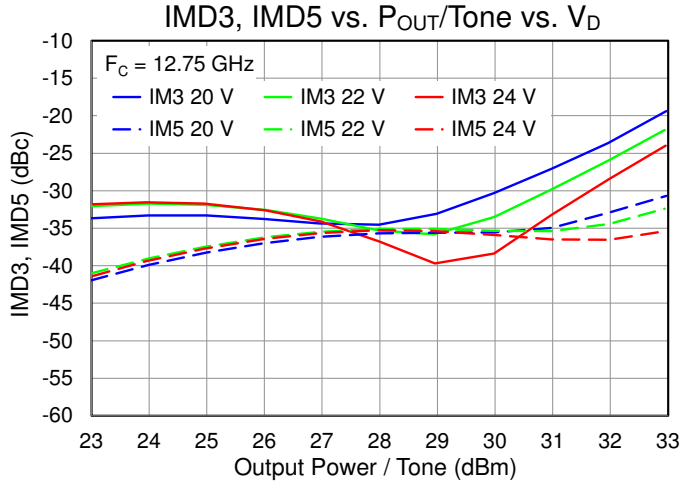

Performance Plots – Linearity (CW)

Test conditions, unless otherwise noted: CW,  $V_D = 24\text{ V}$ ,  $I_{DQ} = 195\text{ mA}$  ( $I_{D12} = 131\text{ mA}$ ,  $I_{D3} = 64\text{ mA}$ ), Tone Spacing = 20 MHz,  $T_{BASE} = +25\text{ }^\circ\text{C}$  ( $T_{BASE}$  is backside of QPA0015).

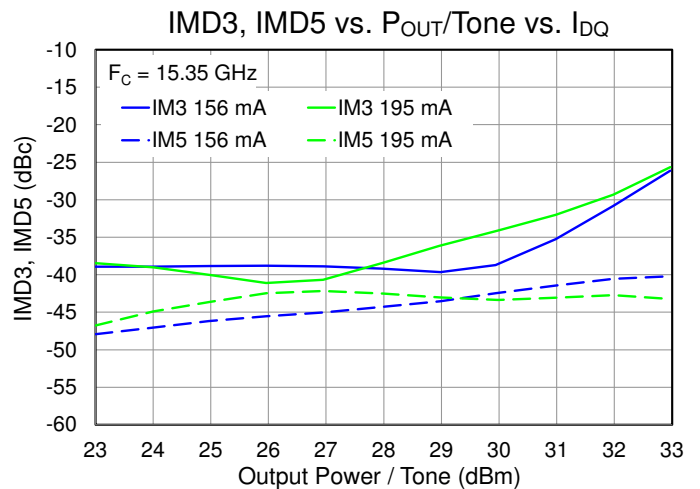
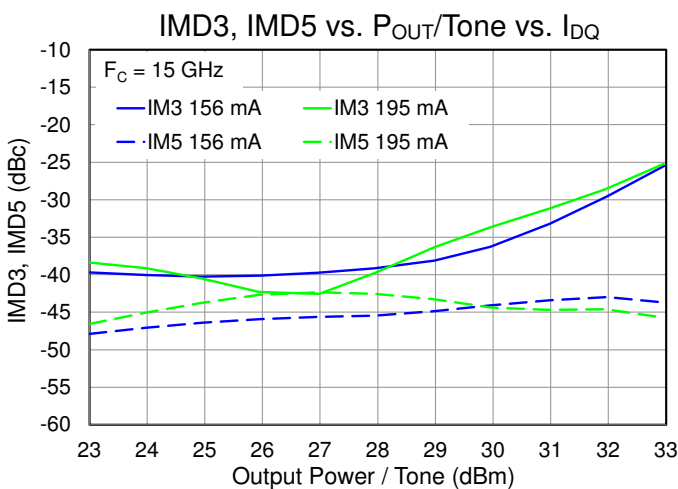
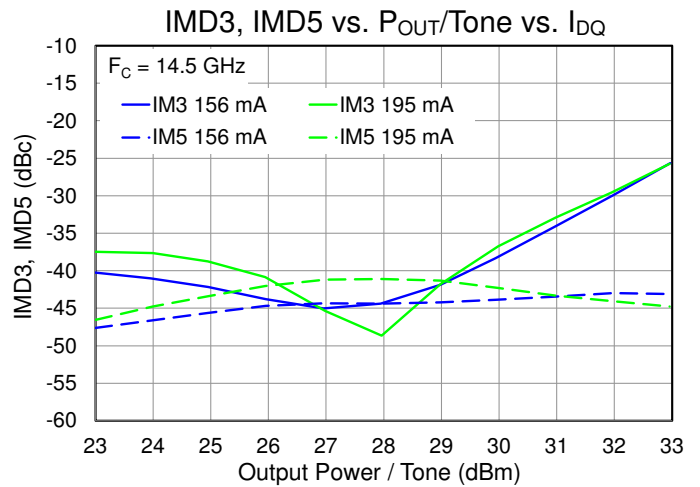
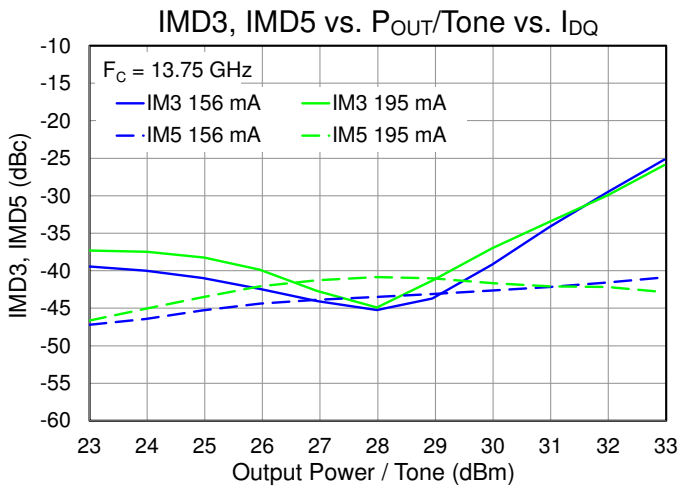
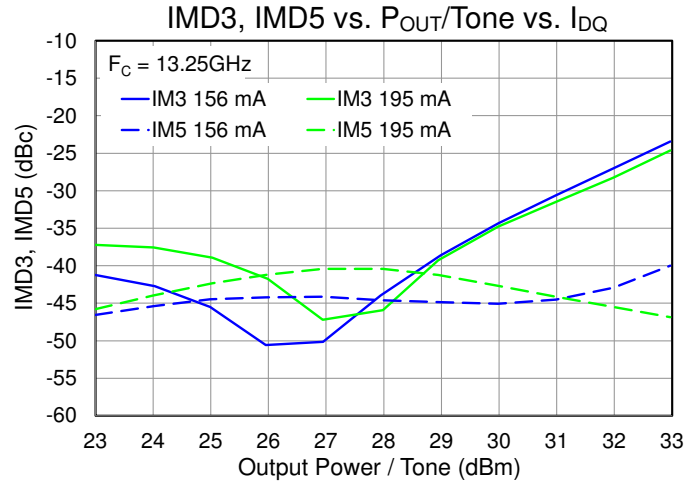
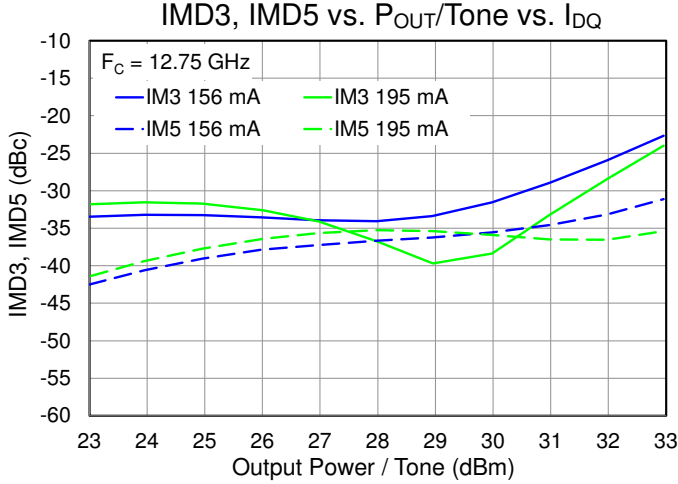

Performance Plots – Linearity (CW)

Test conditions, unless otherwise noted: CW,  $V_D = 24\text{ V}$ ,  $I_{DQ} = 195\text{ mA}$  ( $I_{D12} = 131\text{ mA}$ ,  $I_{D3} = 64\text{ mA}$ ),  $F_C = 14.125\text{ GHz}$ ,  $T_{BASE} = +25\text{ }^\circ\text{C}$  ( $T_{BASE}$  is backside of QPA0015).

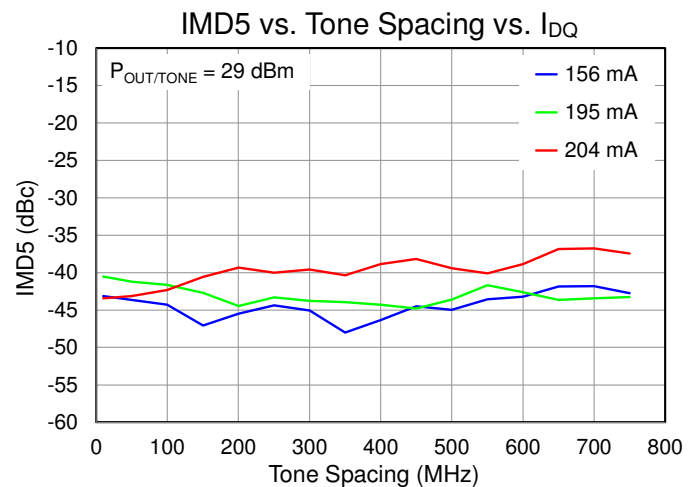
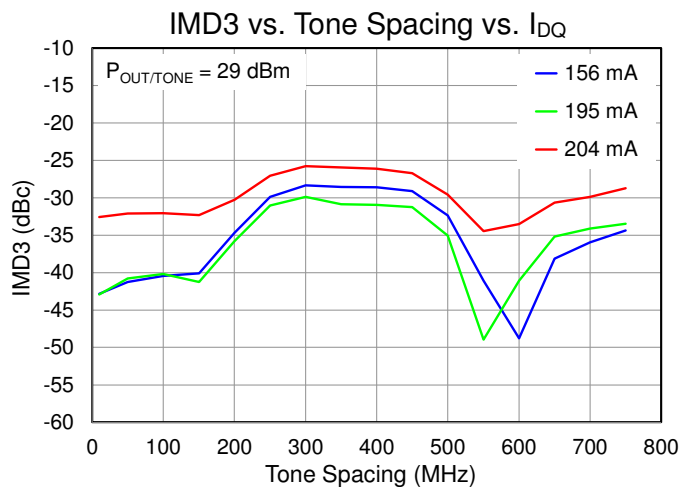
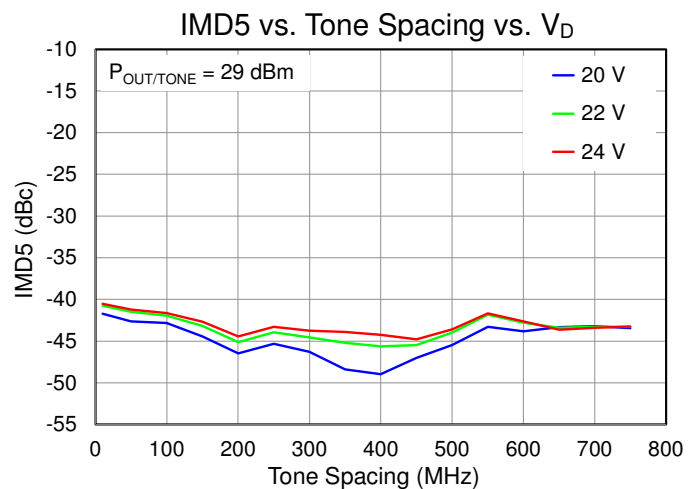
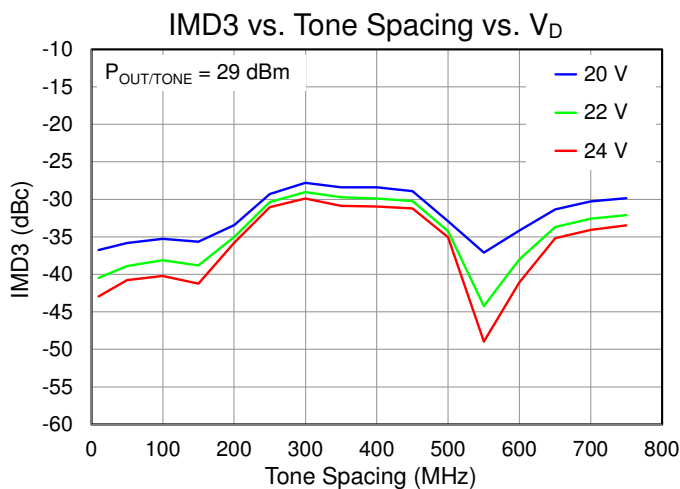
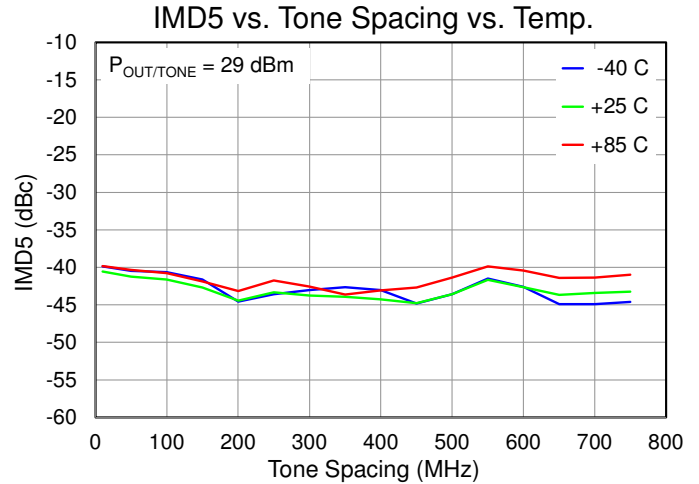
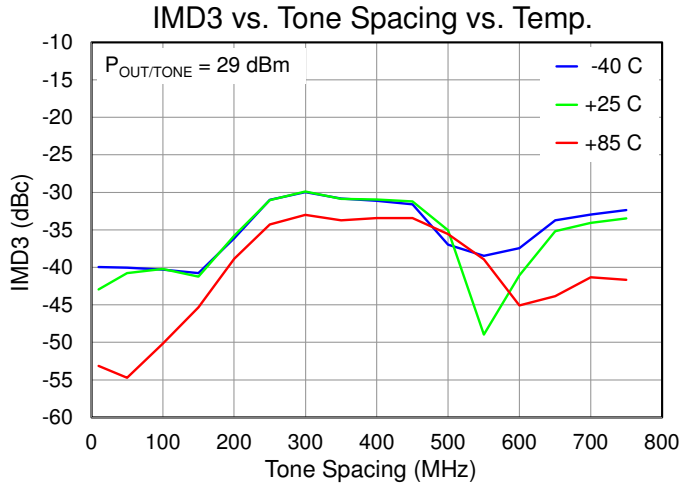

Performance Plots – Linearity (CW)

Test conditions, unless otherwise noted: CW,  $V_D = 24\text{ V}$ ,  $I_{DQ} = 195\text{ mA}$  ( $I_{D12} = 131\text{ mA}$ ,  $I_{D3} = 64\text{ mA}$ ),  $F_C = 14.125\text{ GHz}$ ,  $T_{BASE} = +25\text{ }^\circ\text{C}$  ( $T_{BASE}$  is backside of QPA0015).

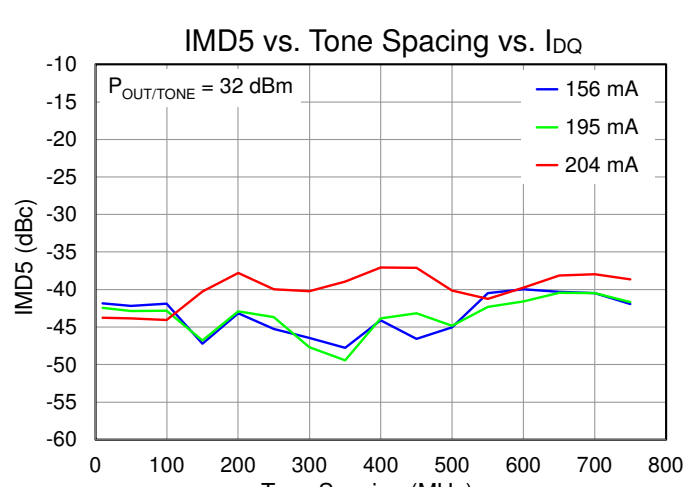
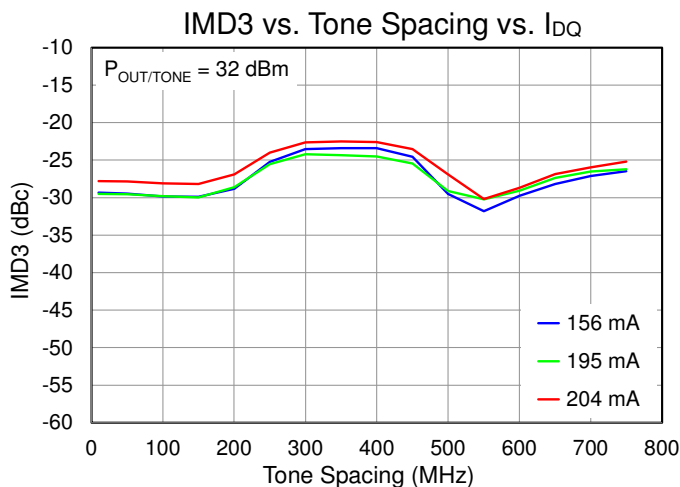
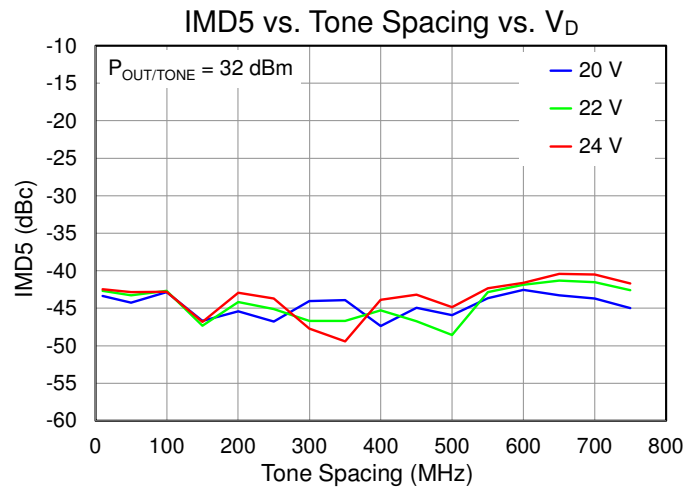
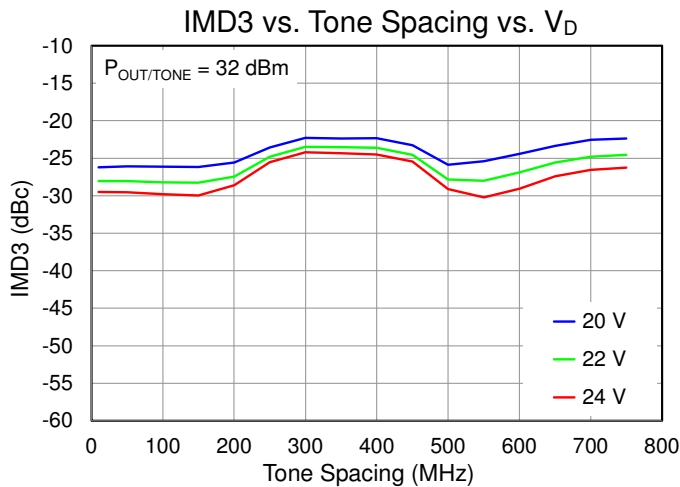
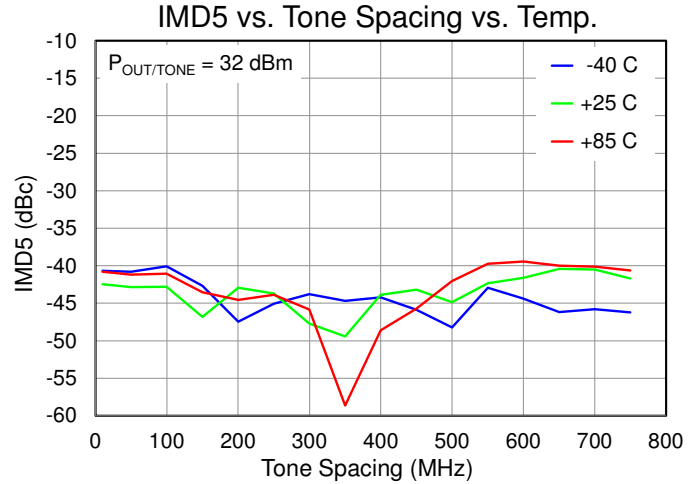
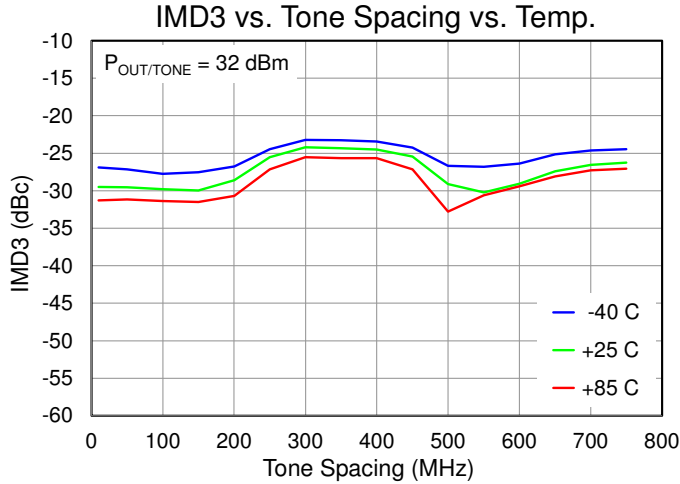

Performance Plots – Small Signal (CW)

Test conditions, unless otherwise noted: CW,  $V_D = 24\text{ V}$ ,  $I_{DQ} = 195\text{ mA}$  ( $I_{D12} = 131\text{ mA}$ ,  $I_{D3} = 64\text{ mA}$ ),  $P_{IN} = -30\text{ dBm}$ ,  $T_{BASE} = +25\text{ }^\circ\text{C}$  ( $T_{BASE}$  is backside of QPA0015).

Gain vs. Freq. vs. Temp.

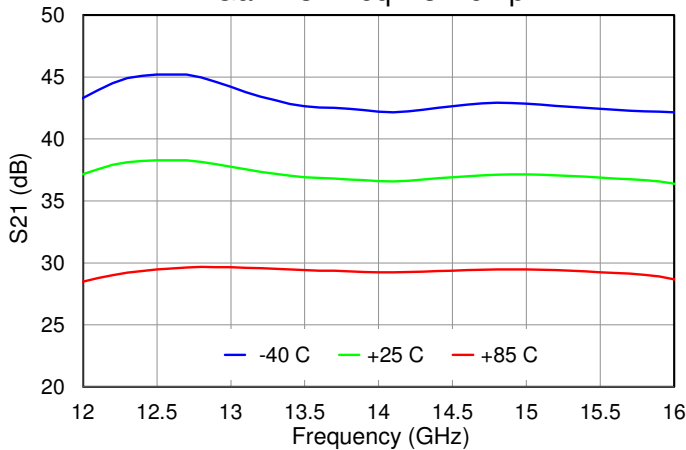

Gain vs. Frequency vs.  $V_D$

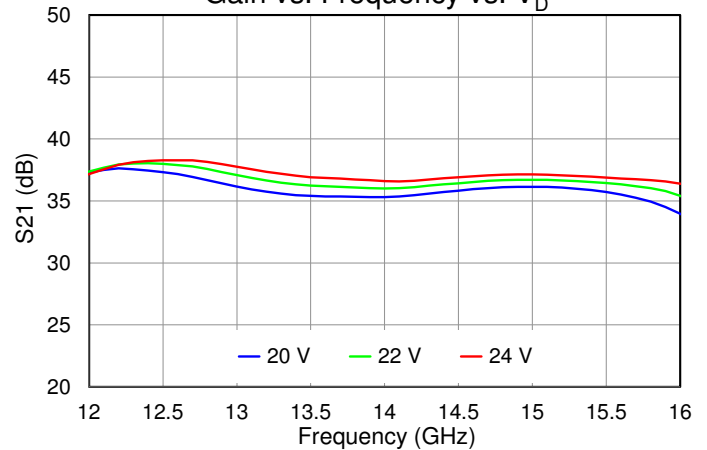

Input RL vs. Freq. vs. Temp.

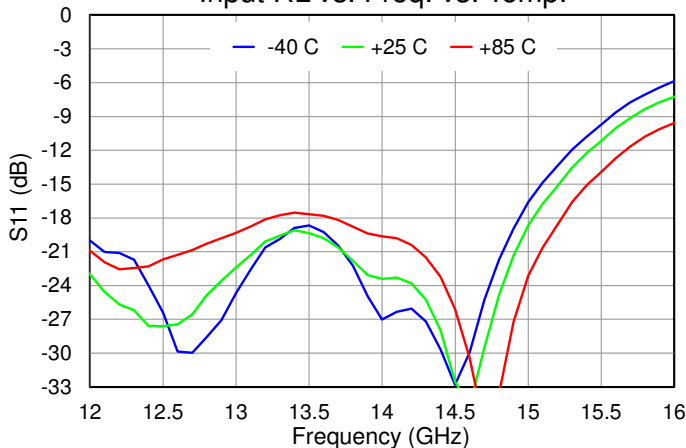

Input RL vs. Frequency vs.  $V_D$

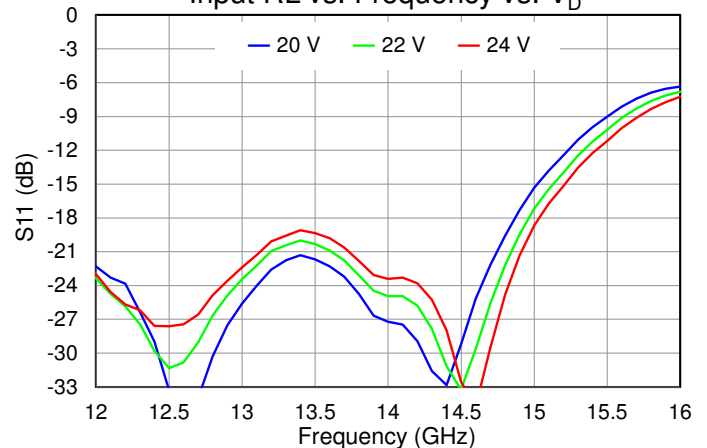

Output RL vs. Freq. vs. Temp.

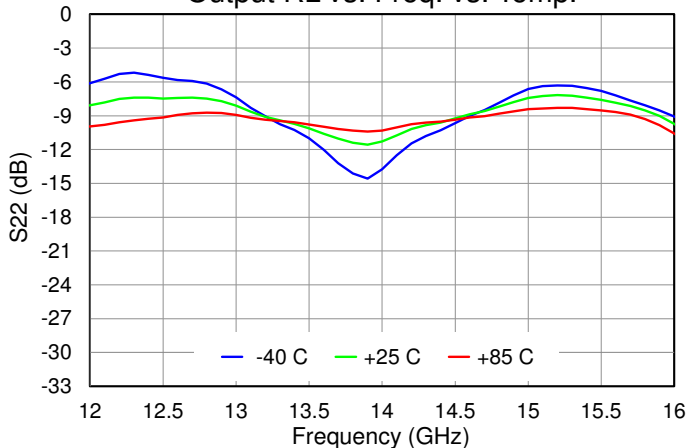

Output RL vs. Frequency vs.  $V_D$

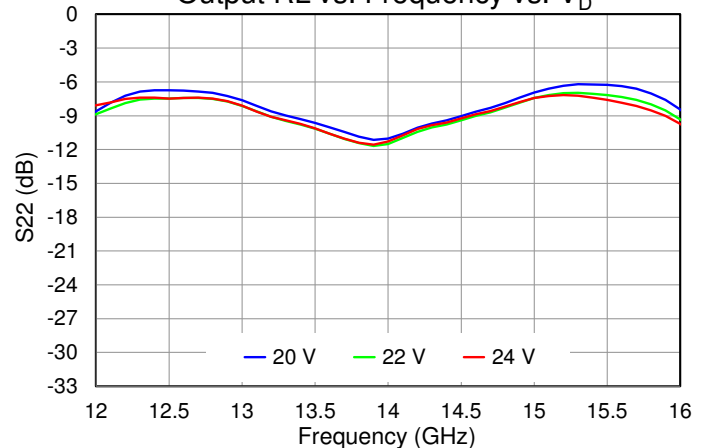

Performance Plots – Small Signal (CW)

Test conditions, unless otherwise noted: CW,  $V_D = 24\text{ V}$ ,  $I_{DQ} = 195\text{ mA}$  ( $I_{D12} = 131\text{ mA}$ ,  $I_{D3} = 64\text{ mA}$ ),  $P_{IN} = -30\text{ dBm}$ ,  $T_{BASE} = +25\text{ }^\circ\text{C}$  ( $T_{BASE}$  is backside of QPA0015).

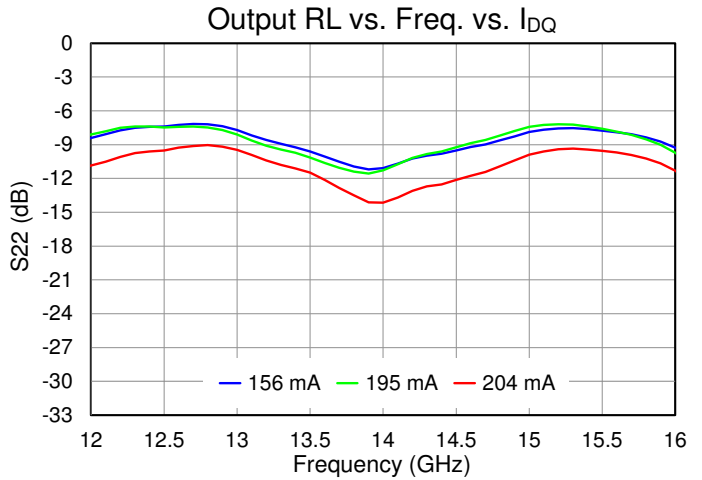
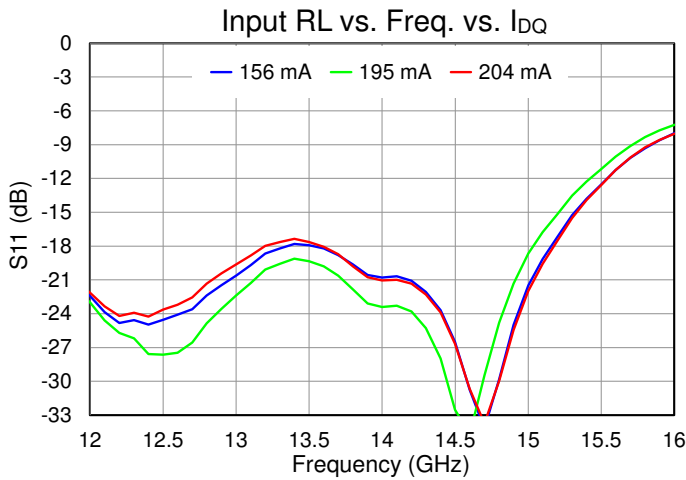
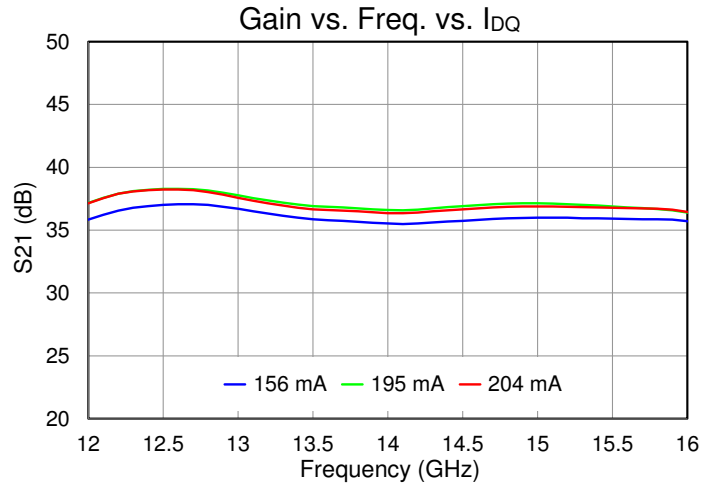

## Thermal and Reliability Information

Parameter	Test Conditions	Value	Units
Thermal Resistance, $\theta_{JC}$ <sup>(1)</sup>	Quiescent, no RF	3.00	$^{\circ}\text{C}/\text{W}$
Channel Temperature, $T_{CH}$ <sup>(2)</sup>	$T_{BASE} = 85^{\circ}\text{C}$ , $V_D = 24\text{ V}$ , $I_{DQ} = 195\text{ mA}$ ( $I_{D12} = 131\text{ mA}$ , $I_{D3} = 64\text{ mA}$ ), $P_{DISS} = 4.68\text{ W}$	99	$^{\circ}\text{C}$
Thermal Resistance, $\theta_{JC}$ <sup>(1)</sup>	CW, $P_{IN} = 10\text{ dBm}$ (3 W linearity $P_{OUT}$ ), $T_{BASE} = 85^{\circ}\text{C}$ , $V_D = 24\text{ V}$ , $I_{DQ} = 195\text{ mA}$ ( $I_{D12} = 131\text{ mA}$ , $I_{D3} = 64\text{ mA}$ ), $I_{D\_DRIVE} = 860\text{ mA}$ ( $I_{D12\_DRIVE} = 210\text{ mA}$ , $I_{D3\_DRIVE} = 650\text{ mA}$ ), Freq = 14 GHz, $P_{OUT} = 37.8\text{ dBm}$ , $P_{DISS} = 14.6\text{ W}$ .	3.06	$^{\circ}\text{C}/\text{W}$
Channel Temperature, $T_{CH}$ <sup>(2)</sup>		130	$^{\circ}\text{C}$

Notes:

- Thermal resistance determined to  $T_{BASE}$  ( $T_{BASE}$  is backside of package QPA0015; see p. 29 offset temperature based on Qorvo's EVB design for reference).
- Channel temperature indicated is an IR scan equivalent temperature. Thermal resistance is calculated using this value. Additional information can be found in the Qorvo Applications Note "GaN Device TCHMAX Theta-JC and Reliability Estimates," located here <https://www.qorvo.com/products/d/da006480>

## Dissipated Power

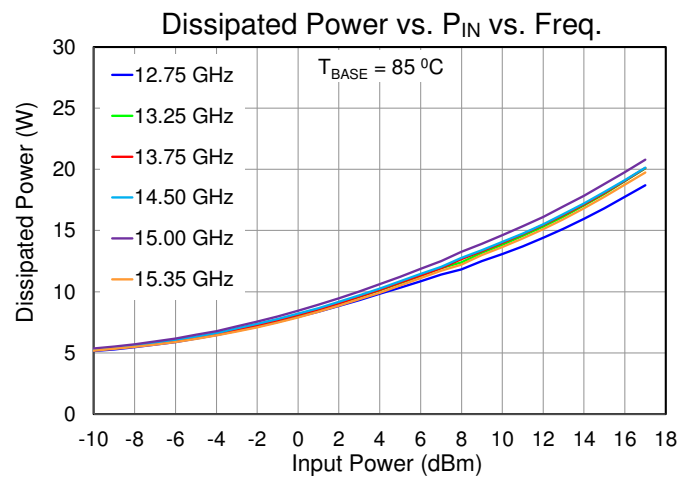
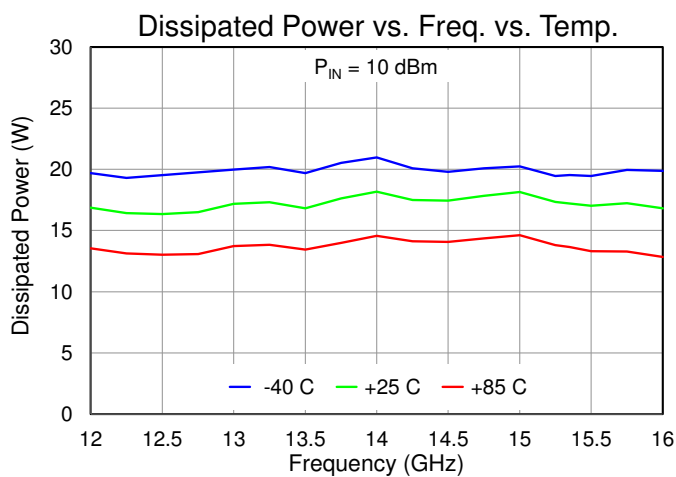

Test conditions, unless otherwise noted.

CW,  $V_D = 24\text{ V}$ ,  $I_{DQ} = 195\text{ mA}$  ( $I_{D12} = 131\text{ mA}$ ,  $I_{D3} = 64\text{ mA}$ ),  $T_{BASE} = 85^{\circ}\text{C}$  ( $T_{BASE}$  is back side of QPA0015)

Maximum Gate Current

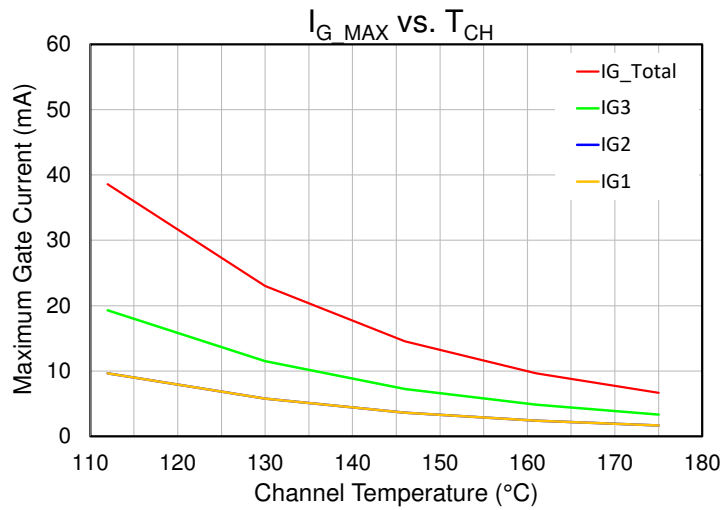

Channel Temperature is an IR scan equivalent

Applications Information

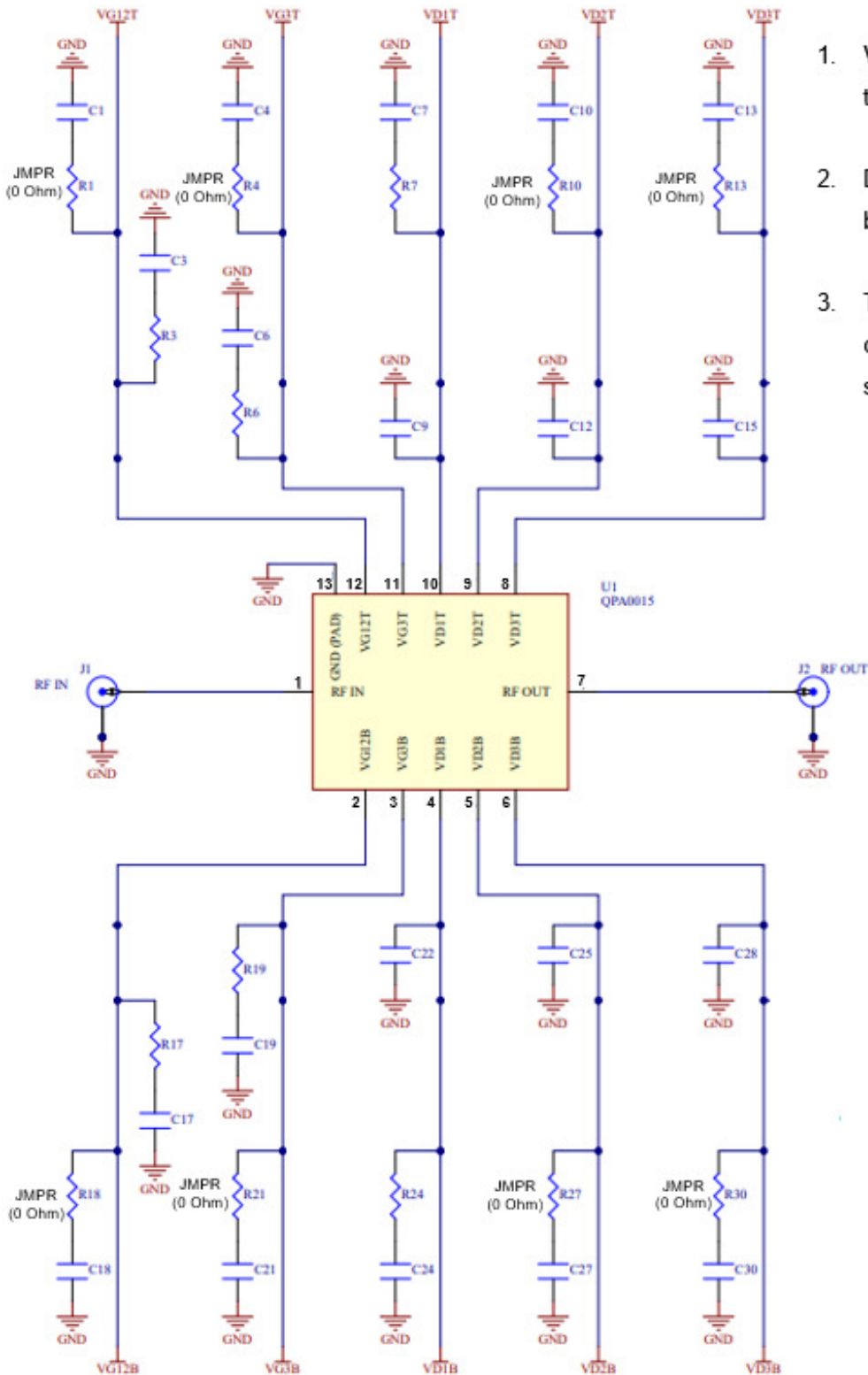

1.  $V_{D1}$  and  $V_{D2}$  can be tied together at the harness level to form  $V_{D12}$ .
2. Drain ( $V_D$ 's) and Gate ( $V_G$ 's) can be biased from either or both sides.
3. The external bypassing components are required on both sides (included for non-bias side).

## Bill of Materials

Reference Des.	Qty	Value	Description	Part Number
C1, C4, C7, C10, C13, C18, C21, C24, C27, C30	10	10 uF	CAP, 10uF, ±20%, 50V, X5R, 1206	
C3, C6, C9, C12, C15, C17, C19, C22, C25, C28	10	0.01 uF <sup>(1)</sup>	CAP, 0.01uF, ±10%, 50V, X7R, 0402	
R1, R4, R10, R13, R18, R21, R27, R30	8	0 Ω	RES, 0 Ohm, JMPR, 0402	
R3, R6, R17, R19	4	10 Ω	RES, 10 Ohm, ±1%, 1/16W, 0402	
R7, R24	2	0 Ω	RES, 0 Ohm, 1/10W, 0603	
PCB	1		PCB for QPA0015 (Cu-coined via, see page 28)	Qorvo, Custom
H1, H2	2		DC Header, ST, 2x6, 0.100", SMD	
J1, J2	2		RF Connector, 2.92mm, F, Pin 0.005, Diel 0.029	Southwest Microwave
H-Block	1		H-Block, Copper C110, 1.248 x 2.246 x 0.275 in	Qorvo, Custom
S1 – S4	4		Screw, Cap, Socket Head, 2-56X1/8"	
Solder Preform			Solder, Preform, 0.400 x 0.320 x 0.002 in	
Solder			Paste, solder, Syntech, Sn63/Pb37	

1. Place as close to QPA0015 as possible (recommended < 12 mils from QPA0015)

## Bias-Up Procedure

1. Set limit:  $I_{D12}$  to 750 mA,  $I_{D3}$  to 1200 mA,  $I_{G12}/I_{G12}$  to 20 mA each.
2. Set  $V_{G12} = V_{G3} = -3.5$  V
3. Set  $V_{D12} = V_{D3} = +24$  V. Ensure  $I_{D12}$  and  $I_{D3} \sim 0$  mA
4. Adjust  $V_{G12}$  more positive until  $I_{D12} = 131$  mA;  $V_{G12} \approx -2.3$  V  
Adjust  $V_{G3}$  more positive until  $I_{D3} = 64$  mA;  $V_{G3} \approx -2.3$  V  
 $I_{DQ} = I_{D12} + I_{D3} = 195$  mA;  $V_G$  +/- 0.7 V typical range
5. Apply RF signal

## Bias-Down Procedure

1. Turn off RF signal
2. Reduce  $V_G$  to  $-3.5$  V. Ensure  $I_{DQ} \sim 0$  mA
3. Set  $V_D$  to 0 V
4. Turn off  $V_D$  supply
5. Turn off  $V_G$  supply

If using three (3) bias supplies for  $V_D$ ,  $V_{G12}$ ,  $V_{G3}$ : combining all three  $V_D$ 's together, adjusting  $V_{G12}$  to achieve  $I_{DQ} = I_{D12}$ , then adjusting  $V_{G3}$  to achieve  $I_{DQ} = I_{D12} + I_{D3}$

Evaluation Board (EVB) Layout

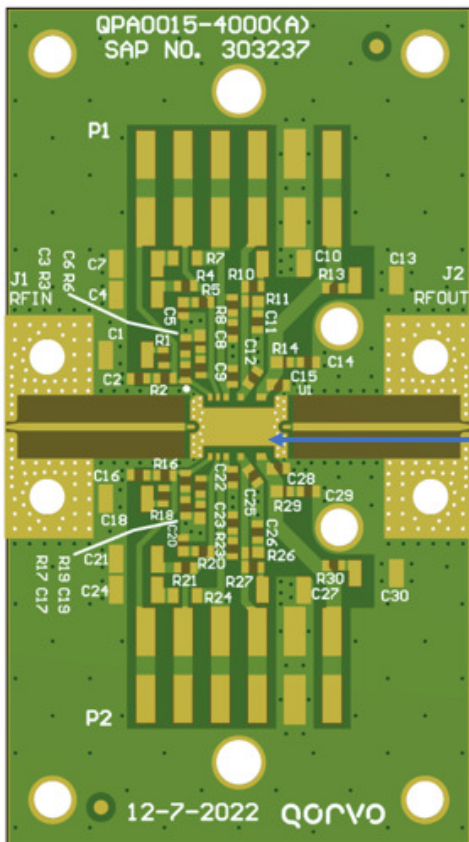
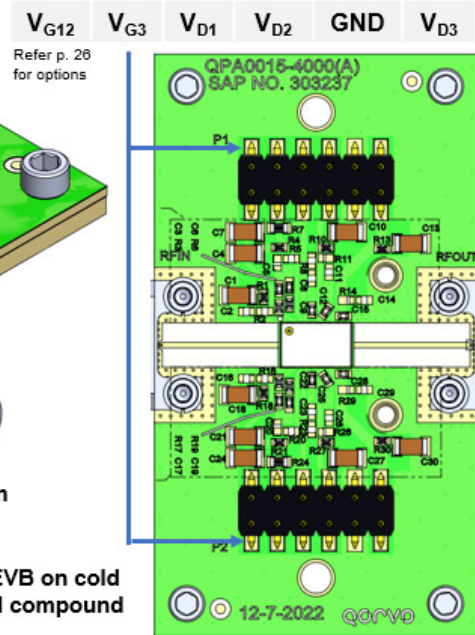
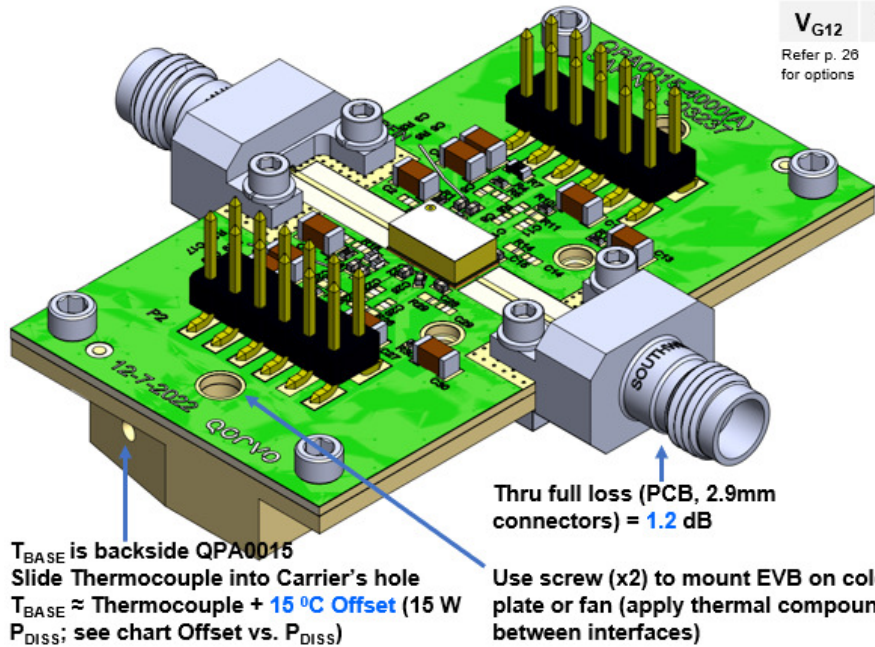

LAYER STACK LEGEND (COPPER THICKNESS IS ~ FINISHED THICKNESS)

Material	Layer	Thickness	Dielectric Material	Type
Surface Material	Top Overlay			Legend
	Top Overlay			Solder Mask
Copper	METAL1_TOP	0.0020in		Signal
Core		0.0100in	TACONICS RF-35HTC	Dielectric
Copper	METAL2_MID1	0.0006in		Signal
Prepreg		0.0085in	370HR	Dielectric
Copper	METAL3_MID2	0.0006in		Signal
Core		0.0100in	370HR	Dielectric
Copper	METAL4_BOT	0.0020in		Signal
Total thickness: 0.0347in				

**Cu-coin Via, 0.168 x 0.072 in**  
Offset Temp. (Thermocouple -  $T_{BASE}$ ) @ 15 W  $P_{DISS}$ :  
Cu coined: ~ 15 °C  
Cu filled: ~ 25 °C

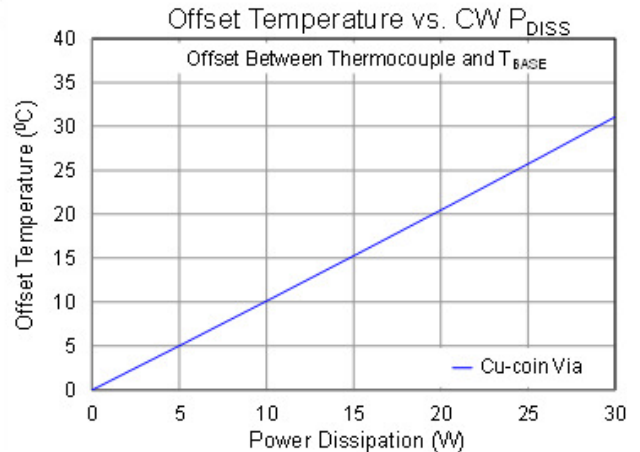

Mechanical Information

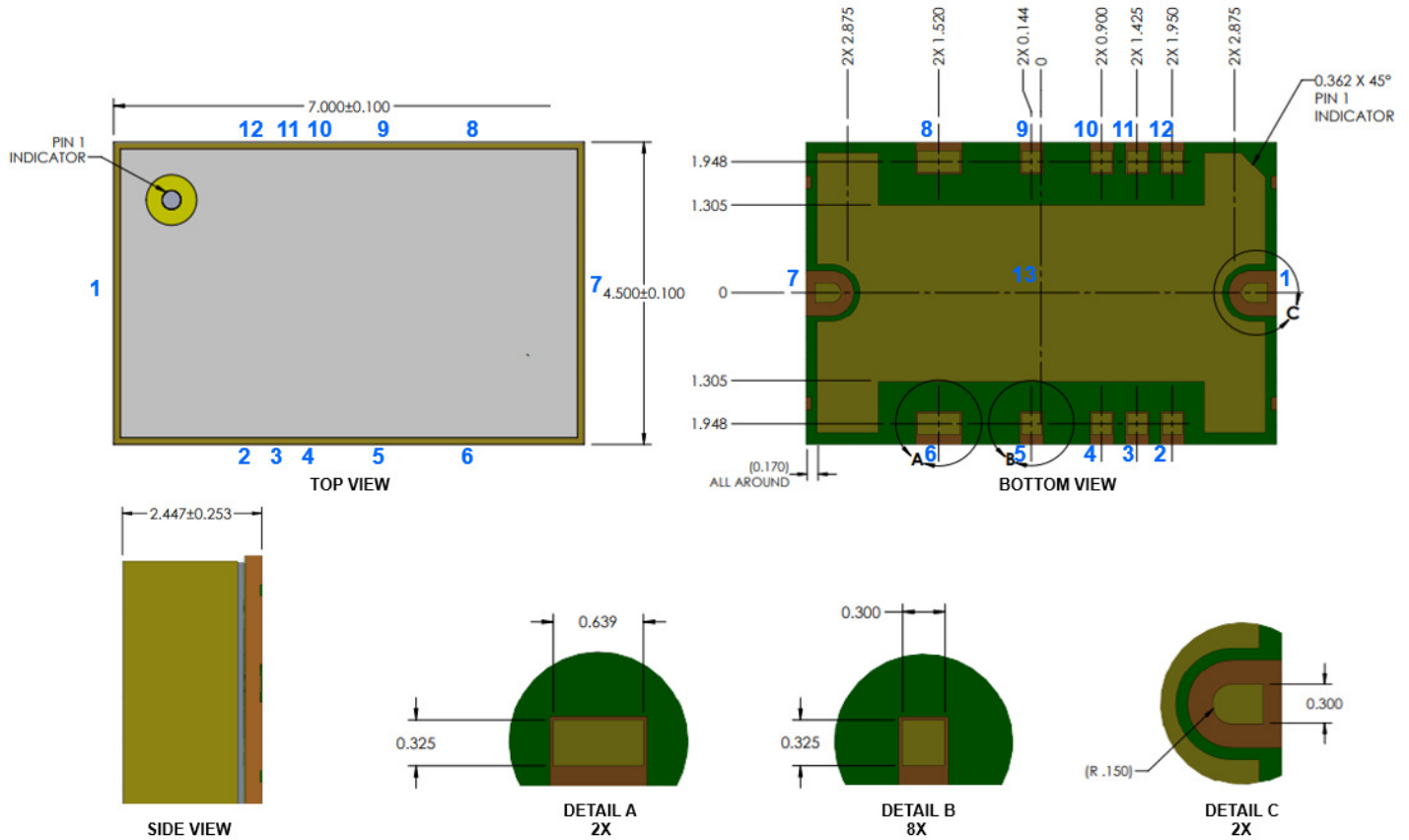

Dimensions (unless otherwise specified): mm.

Tolerances (unless noted): .xx = ± .25; .xxx = ± .100; .xxxx = ± .0254; angles = 0.5°

Package is air-cavity, non-hermetic, epoxy sealed; lid is FR4; base is laminate; leads are Au plated.

Pin Description

Pin Number	Symbol	Description
1	RF <sub>IN</sub>	RF Input. Matched to 50 Ω, DC blocked, DC shorted to ground
2, 12	V <sub>G12</sub>	Gate voltage for stage 1 and 2 <sup>(1)</sup>
3, 11	V <sub>G3</sub>	Gate voltage for stage 3 <sup>(1)</sup>
4, 10	V <sub>D1</sub>	Drain voltage for stage 1 <sup>(1)</sup>
5, 9	V <sub>D2</sub>	Drain voltage for stage 2 <sup>(1)</sup>
6, 8	V <sub>D3</sub>	Drain voltage for stage 3 <sup>(1)</sup>
7	RF <sub>OUT</sub>	RF Output. Matched to 50 Ω, DC blocked, DC shorted to ground
13	GND	Ground (backside paddle); grounded on PCB; Cu-coined via should be employed to minimize inductance and thermal resistance

1. External bypassing required; refer to page 27 for recommendation.

**Tape & Reel Information**

Standard T/R size = 200 pieces on a 7" reel.

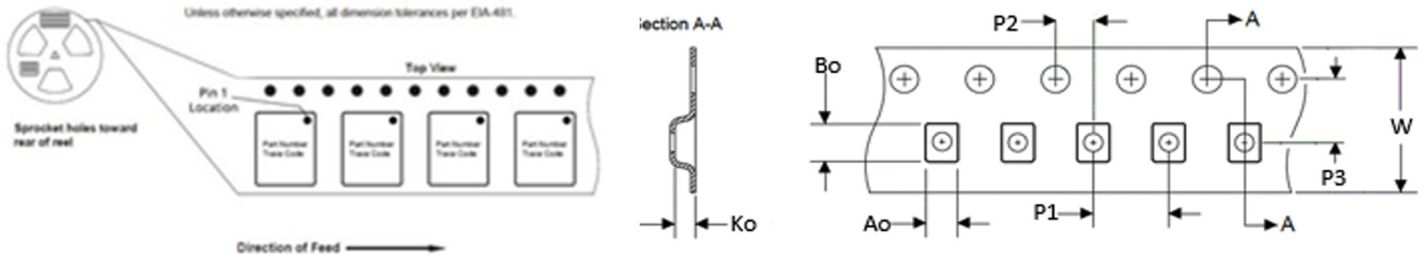

Feature	Measure	Symbol	Size (in)	Size (mm)
Cavity	Length	A0	0.197	5.0
	Width	B0	0.295	7.5
	Depth	K0	0.110	2.8
	Pitch	P1	0.315	8.0
Centerline Distance	Cavity to Perforation - Length Direction	P2	0.079	2.0
	Cavity to Perforation - Width Direction	P3	0.295	7.50
Cover Tape	Width	C	0.524	13.3
Carrier Tape	Width	W	0.630	16.0

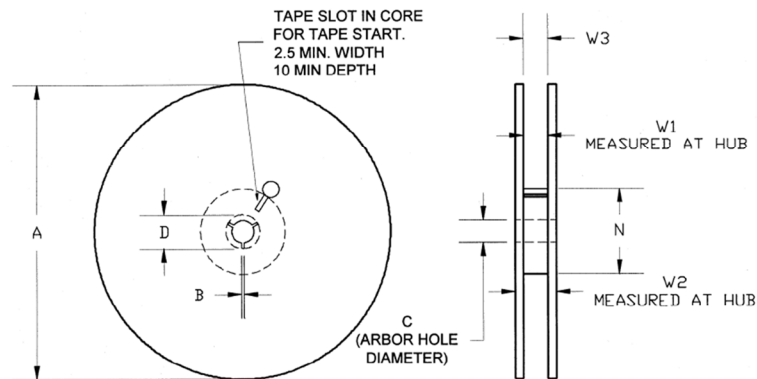

Feature	Measure	Symbol	Size (in)	Size (mm)
Flange	Diameter	A	12.992	330
	Thickness	W2	0.882	22.4
	Space Between Flange	W1	.646	16.4
Hub	Outer Diameter	N	4.016	102.0
	Arbor Hole Diameter	C	0.512	13.0
	Key Slit Width	B	0.079	2.0
	Key Slit Diameter	D	.795	20.2

Solderability

Compatible with the latest version of J-STD-020, lead-free solder, 260 °C peak reflow temperature

This package is air-cavity and non-hermetic, and therefore cannot be subjected to aqueous washing. The use of no-clean solder to avoid washing after soldering is highly recommended.

Contact plating: Ni-Au

Solder rework not recommended.

Recommended Soldering Temperature Profile

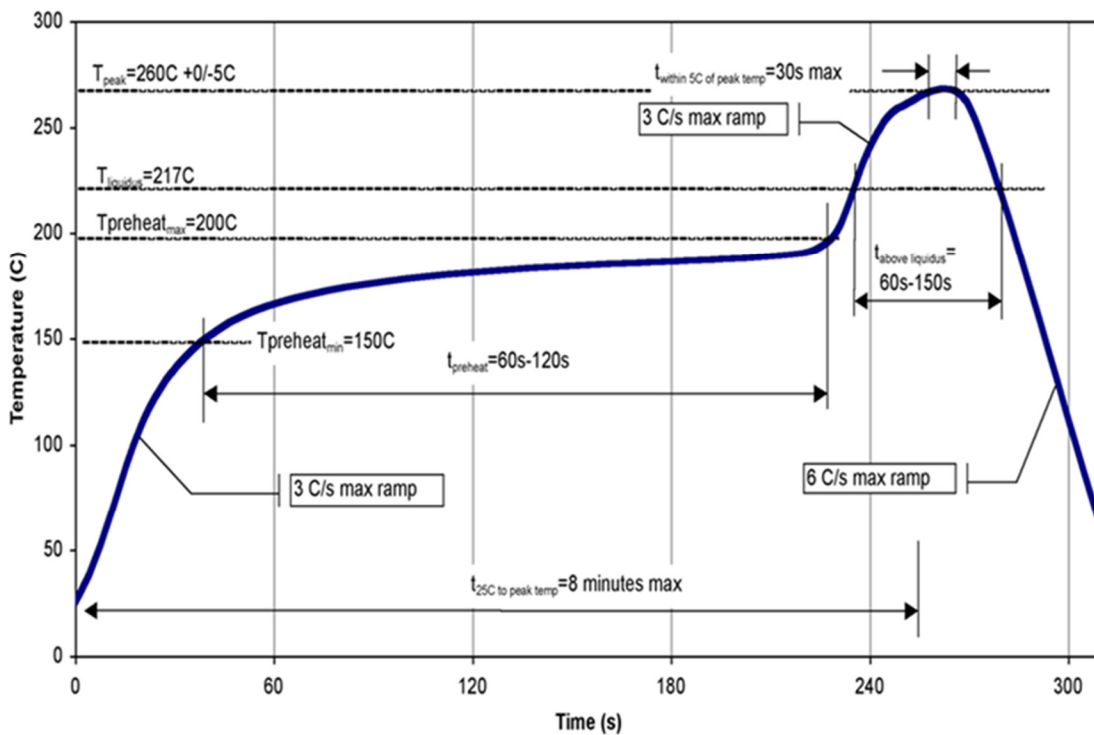

## Handling Precautions

Parameter	Rating	Standard
ESD – Human Body Model (HBM)	1A	ANSI/ESD/JEDEC JS-001
ESD – Charged Device Model (CDM)	C3	ANSI/ESD/JEDEC JS-002
MSL – Moisture Sensitivity Level	5A	IPC/JEDEC J-STD-020



Caution!

ESD-Sensitive Device

## RoHS Compliance

This part is compliant with 2011/65/EU RoHS directive (Restrictions on the Use of Certain Hazardous Substances in Electrical and Electronic Equipment) as amended by Directive 2015/863/EU.

This product also has the following attributes:

- Lead Free
- Antimony Free
- TBBP-A (C<sub>15</sub>H<sub>12</sub>Br<sub>4</sub>O<sub>2</sub>) Free
- PFOS Free
- SVHC Free

## Contact Information

For the latest specifications, additional product information, worldwide sales and distribution locations:

Web: [www.qorvo.com](http://www.qorvo.com)

Tel: 1-844-890-8163

Email: [customer.support@qorvo.com](mailto:customer.support@qorvo.com)

## Important Notice

The information contained herein is believed to be reliable; however, Qorvo makes no warranties regarding the information contained herein and assumes no responsibility or liability whatsoever for the use of the information contained herein. All information contained herein is subject to change without notice. Customers should obtain and verify the latest relevant information before placing orders for Qorvo products. The information contained herein or any use of such information does not grant, explicitly or implicitly, to any party any patent rights, licenses, or any other intellectual property rights, whether with regard to such information itself or anything described by such information. **THIS INFORMATION DOES NOT CONSTITUTE A WARRANTY WITH RESPECT TO THE PRODUCTS DESCRIBED HEREIN, AND QORVO HEREBY DISCLAIMS ANY AND ALL WARRANTIES WITH RESPECT TO SUCH PRODUCTS WHETHER EXPRESS OR IMPLIED BY LAW, COURSE OF DEALING, COURSE OF PERFORMANCE, USAGE OF TRADE OR OTHERWISE, INCLUDING THE IMPLIED WARRANTIES OF MERCHANTABILITY AND FITNESS FOR A PARTICULAR PURPOSE.**

Without limiting the generality of the foregoing, Qorvo products are not warranted or authorized for use as critical components in medical, life-saving, or life-sustaining applications, or other applications where a failure would reasonably be expected to cause severe personal injury or death.

© 2024 Qorvo US, Inc. All rights reserved. This document is subject to copyright laws in various jurisdictions worldwide and may not be reproduced or distributed, in whole or in part, without the express written consent of Qorvo US, Inc.

## Looking for pricing, stock, or lifecycle information?

Click below to explore more details on WIN SOURCE:

 [View QPA0015 on WIN SOURCE](#)

 [Qorvo US Inc. Information](#)

## Optimize Your Supply Chain with WIN SOURCE Solutions

-  Global Sourcing Solution
-  Obsolete Management
-  Cost Control Management
-  Shortage Management
-  Alternative Solution
-  Excess Inventory Management