

# DMT334R2S474M3DTA0 / Supercapacitor(EDLC)

RoHS

REACH

Hand Soldering Only

## DMT series: General-Purpose Type

~Featuring low ESR, small&slim package, and wide operation temperature range up to 85°C ~

### [Features]

- Wide Operational Temperature : -40°C to 85°C
- High Power: Discharge up to 10A max. per piece
- Low ESR(equivalent series resistance)
- Small and Slim Package (21.0 x 14.0 x 3.5mm)
- High Reliability: Characteristic degradation is reduced by airtight package and optimized electrochemical system
- Low leakage current : less than 5μA @96hrs

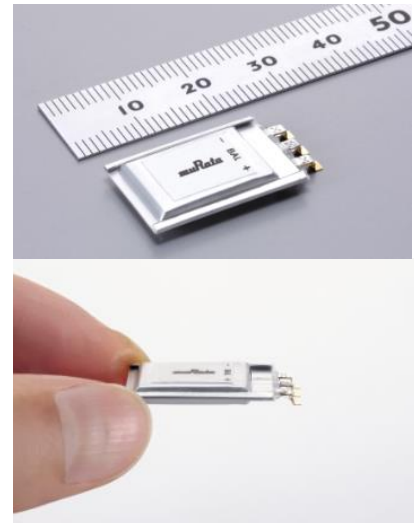

### [Application Examples]

- **Backup** : SSD, PLC, UPS, ATM, etc.
- **Peak power assist** : IoT devices, sensor node, wearable devices, RKE, handy terminals, smart meters(wireless communication system, valve operation), motor-driven devices, e-paper, and so on.
- **Battery Peak Load Leveling** : Portable devices, GPS/GPRS tracking system, POS, Insulin pump, and so on.
- **Energy Harvest** : Supercapacitor can be used as maintenance-free storage device with flexible charge-discharge

Part Number	Rated voltage(V)	Capacitance (mF)	ESR@1kHz (mΩ)	LxW (mm)	Thickness (mm)	Operation temp.
DMT334R2S474M3DTA0	4.2	470	130	21x14	3.5(Max3.8)	-40°C~+85°C

### 1. Dimensions

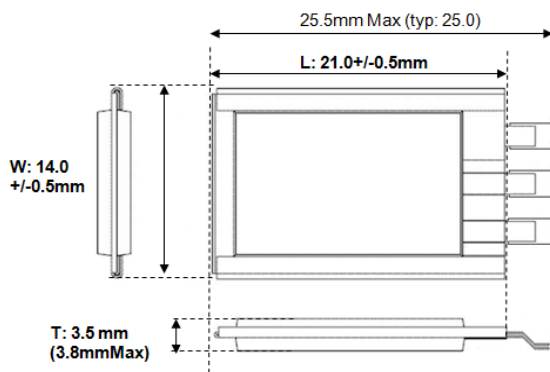

### 2. Leakage Current

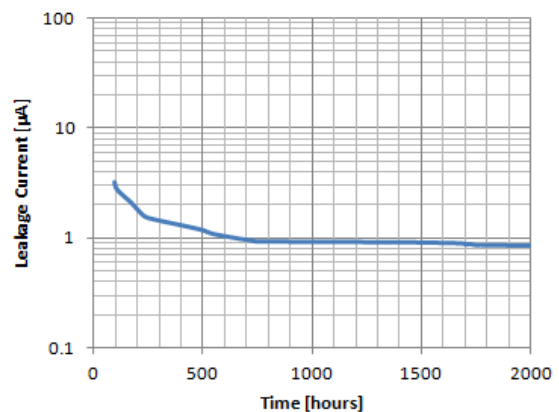

### 3. Temperature Characteristics(V.S. 25°C)

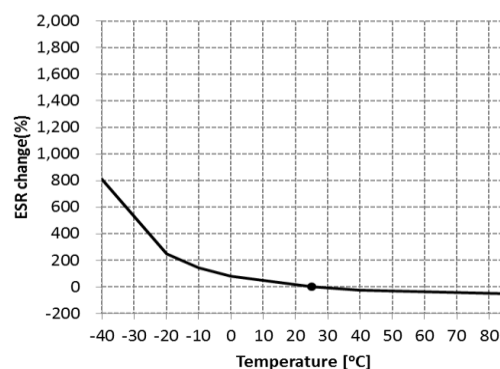
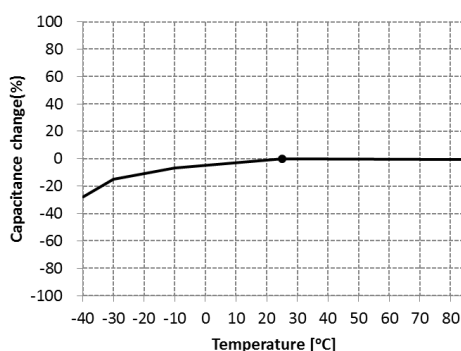

## 4. Discharge Characteristics

### ➤ Constant Current Discharge

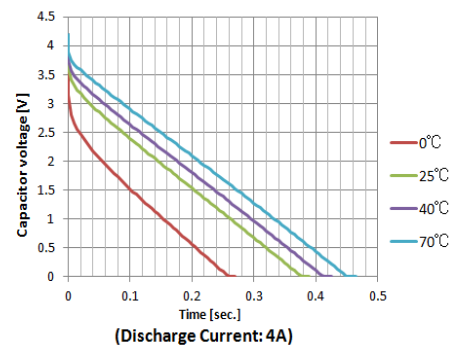
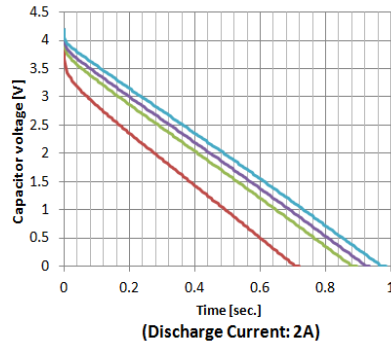
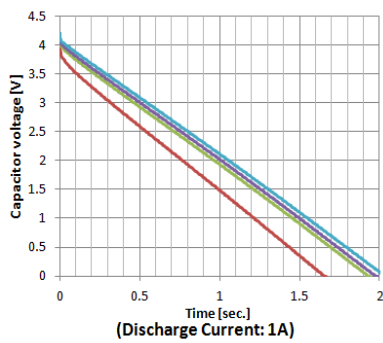

### ➤ Constant Power Discharge

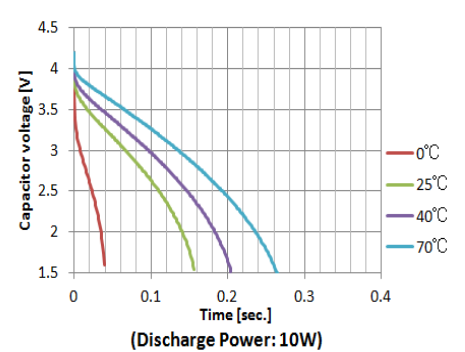
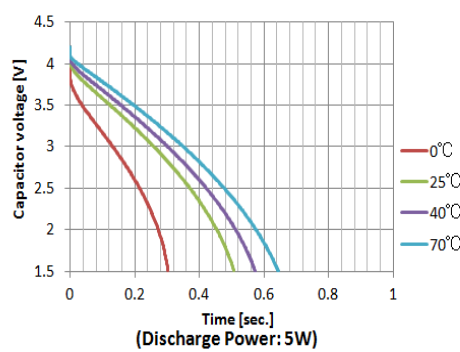
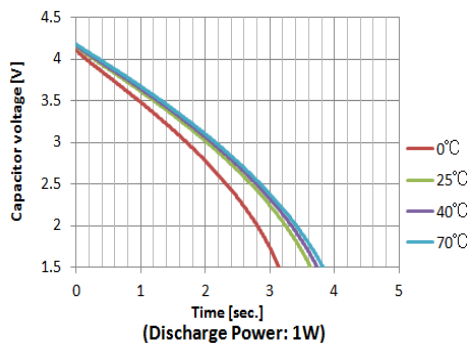

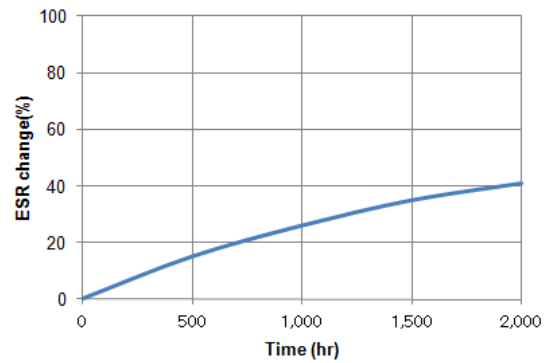
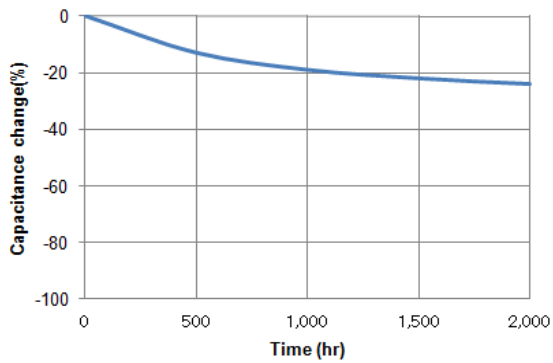

## 5. High Temperature Loading Test (Test Condition: 4.2V / 85°C / 1,000hours)







## Looking for pricing, stock, or lifecycle information?

Click below to explore more details on WIN SOURCE:

-  [View DMT334R2S474M3DTA0 on WIN SOURCE](#)
-  [CAP-XX Information](#)

## Optimize Your Supply Chain with WIN SOURCE Solutions

-  Global Sourcing Solution
-  Obsolete Management
-  Cost Control Management
-  Shortage Management
-  Alternative Solution
-  Excess Inventory Management