



## GaAs HEMT MMIC MEDIUM POWER AMPLIFIER, 71 - 86 GHz

### Typical Applications

This HMC-AUH320 is ideal for:

- Short Haul / High Capacity Links
- Wireless LAN Bridges
- Automotive Radar
- Military & Space
- E-Band Communication Systems

### Features

- Gain: 16 dB @ 74 GHz
- P1dB: +15 dBm
- Supply Voltage: +4V
- 50 Ohm Matched Input/Output
- Die Size: 2.20 x 0.87 x 0.1 mm

### Functional Diagram

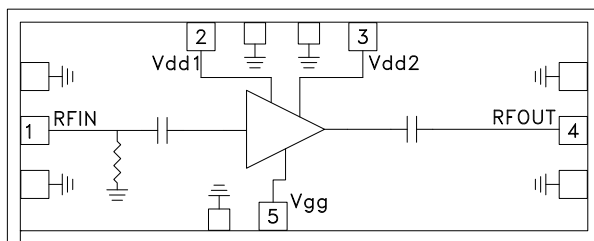

### General Description

The HMC-AUH320 is a high dynamic range, four stage GaAs HEMT MMIC Medium Power Amplifier which operates between 71 and 86 GHz. The HMC-AUH320 provides 16 dB of gain at 74 GHz, and an output power of +15 dBm at 1 dB compression from a +4V supply voltage. All bond pads and the die backside are Ti/Au metallized and the amplifier device is fully passivated for reliable operation. The HMC-AUH320 GaAs HEMT MMIC Medium Power Amplifier is compatible with conventional die attach methods, as well as thermocompression and thermosonic wire bonding, making it ideal for MCM and hybrid microcircuit applications. All data shown herein is measured with the chip in a 50 Ohm environment and RF probes contacting the die pads.

### Electrical Specifications, $T_A = +25^\circ \text{C}$ , $V_{dd1}=V_{dd2} = 4\text{V}$ , $I_{dd1}+I_{dd2} = 130\text{mA}$ [2]

Parameter	Min.	Typ.	Max.	Units
Frequency Range	71 - 86			GHz
Gain	10	16		dB
Input Return Loss		4		dB
Output Return Loss		6		dB
Output power for 1dB Compression (P1dB)		15		dBm
Saturated Output Power (P <sub>sat</sub> )		16		dBm
Supply Current (I <sub>dd1</sub> +I <sub>dd2</sub> )		130		mA

[1] Unless otherwise indicated, all measurements are from probed die

[2] Adjust V<sub>gg</sub> between -0.8V to +0.3V (typ -0.1V) to achieve I<sub>dd1</sub> = 40mA, I<sub>dd2</sub> = 90mA or I<sub>dd<sub>total</sub></sub> = 130 mA.



**GaAs HEMT MMIC MEDIUM POWER  
AMPLIFIER, 71 - 86 GHz**

**Linear Gain vs. Frequency**

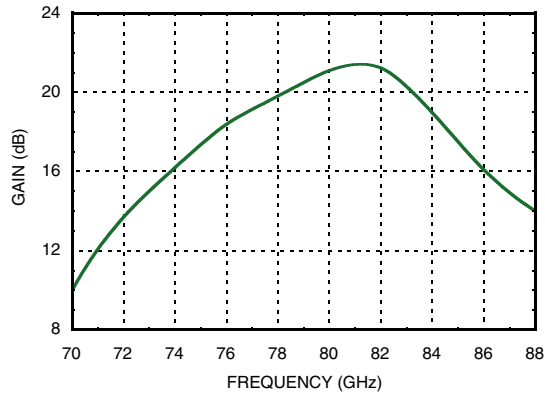

**Fixtured Output Power vs. Frequency**

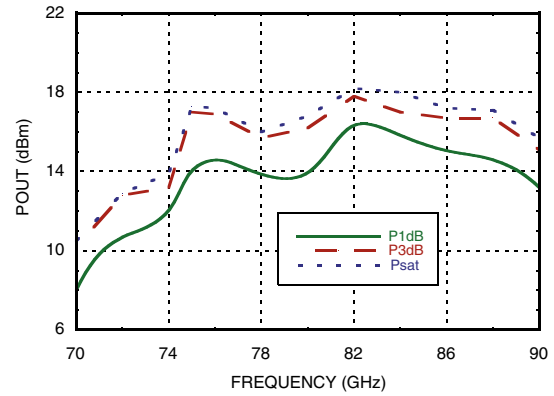

**Input Return Loss vs. Frequency**

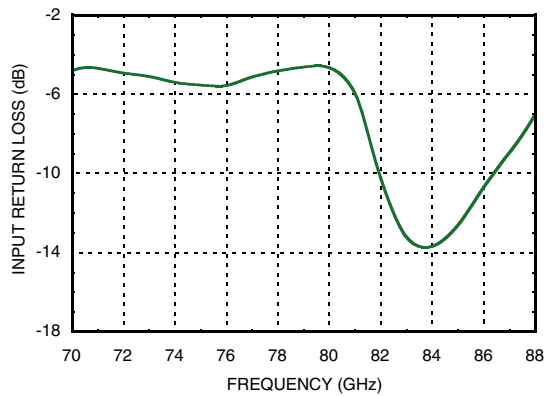

**Output Return Loss vs. Frequency**

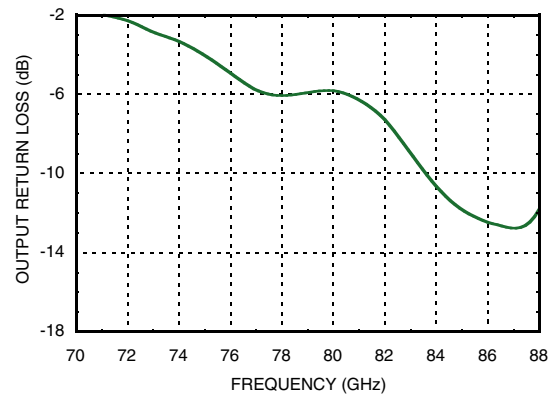

Note: Measured Performance Characteristics (Typical Performance at 25°C) Vdd1 = Vdd2 = 4V and Idd1 = 40mA, Idd2 = 90mA

Information furnished by Analog Devices is believed to be accurate and reliable. However, no responsibility is assumed by Analog Devices for its use, nor for any infringements of patents or other rights of third parties that may result from its use. Specifications subject to change without notice. No license is granted by implication or otherwise under any patent or patent rights of Analog Devices. Trademarks and registered trademarks are the property of their respective owners.

For price, delivery, and to place orders: Analog Devices, Inc., One Technology Way, P.O. Box 9106, Norwood, MA 02062-9106 Phone: 781-329-4700 • Order online at [www.analog.com](http://www.analog.com) Application Support: Phone: 1-800-ANALOG-D



## GaAs HEMT MMIC MEDIUM POWER AMPLIFIER, 71 - 86 GHz

### Absolute Maximum Ratings

Drain Bias Voltage	+4.5 Vdc
Gate Bias Voltage	-0.8 to +0.3 Vdc
Thermal Resistance (Channel to die bottom)	92.1 °C/W
Channel Temperature	180 °C
Storage Temperature	-65 °C to +150 °C
Operating Temperature	-55 °C to +85 °C
Drain Bias Current (I <sub>dd1</sub> )	50mA
Drain Bias Current (I <sub>dd2</sub> )	100mA



ELECTROSTATIC SENSITIVE DEVICE  
OBSERVE HANDLING PRECAUTIONS

### Outline Drawing

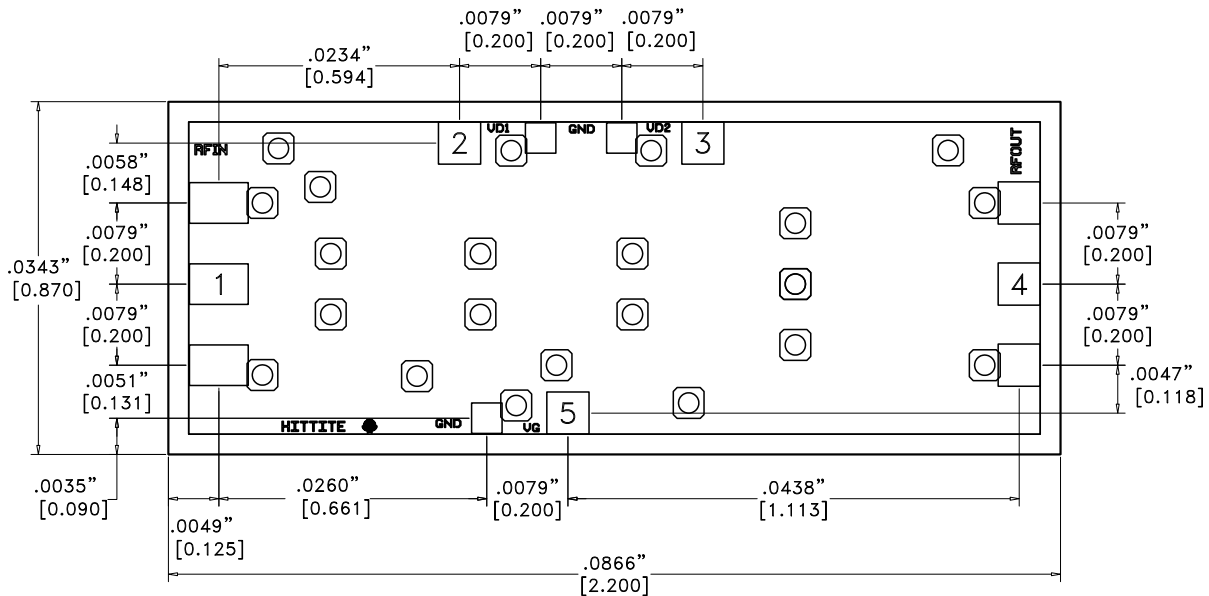

### Die Packaging Information <sup>[1]</sup>

Standard	Alternate
GP-2 (Gel Pack)	[2]

[1] Refer to the "Packaging Information" section for die packaging dimensions.

[2] For alternate packaging information contact Hittite Microwave Corporation.



#### NOTES:

- ALL DIMENSIONS ARE IN INCHES [MM].
- TYPICAL BOND PAD IS .004" SQUARE.
- BACKSIDE METALLIZATION: GOLD.
- BACKSIDE METAL IS GROUND.
- BOND PAD METALLIZATION: GOLD.
- CONNECTION NOT REQUIRED FOR UNLABELED BOND PADS.
- OVERALL DIE SIZE ±.002"
- DIE THICKNESS = .004"

## GaAs HEMT MMIC MEDIUM POWER AMPLIFIER, 71 - 86 GHz

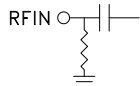
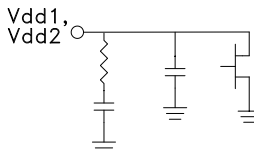
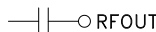
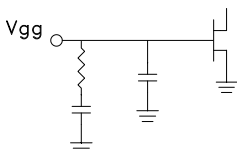

### Pad Descriptions

Pad Number	Function	Description	Interface Schematic
1	RFIN	This pad is DC coupled (for ESD) and matched to 50 Ohms.	
2, 3	Vdd1, Vdd2	Power Supply Voltage for the amplifier. See assembly for required external components.	
4	RFOUT	This pad is AC coupled and matched to 50 Ohms.	
5	Vgg	Gate control for amplifier. See Assembly Drawing for required external components. Please follow "MMIC Amplifier Biasing Procedure" application note.	
Die Bottom	GND	Die bottom must be connected to RF/DC ground.	



**GaAs HEMT MMIC MEDIUM POWER  
AMPLIFIER, 71 - 86 GHz**

**Assembly Diagram**

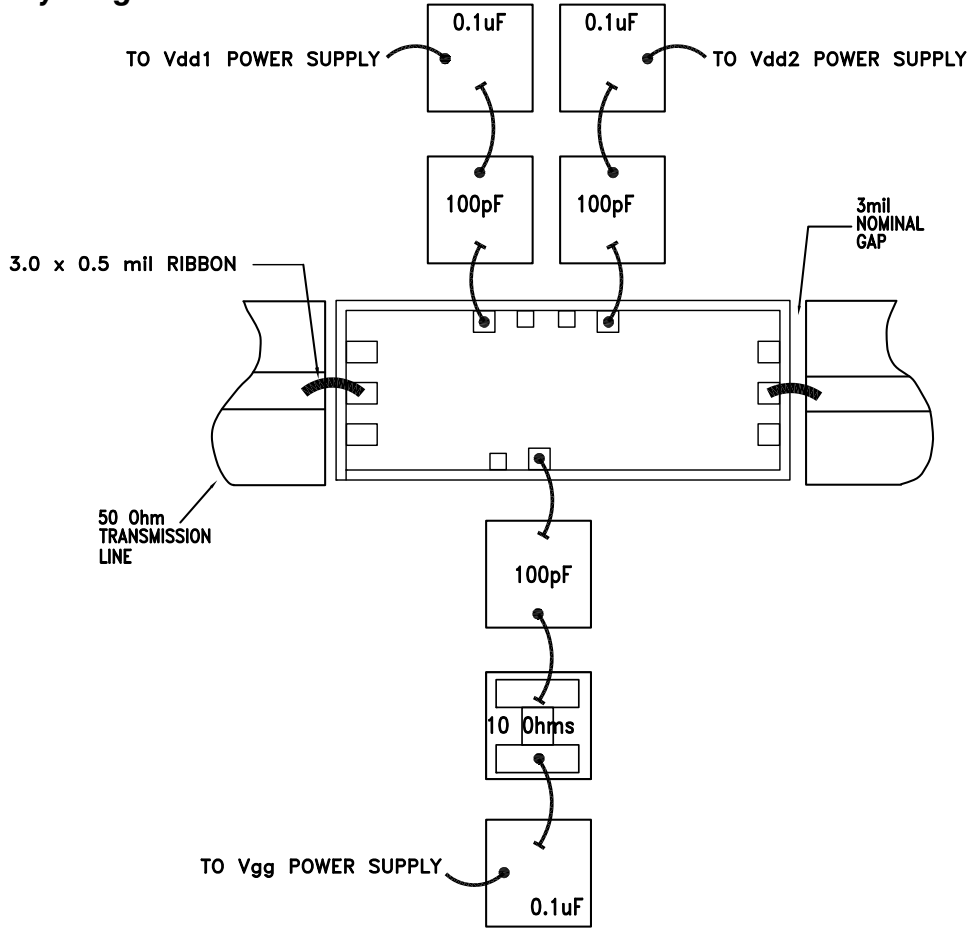

Note 1: Bypass caps should be 100 pF (approximately) ceramic (single-layer) placed no farther than 30 mils from the amplifier

Note 2: Best performance obtained from use of <10 mil (long) by 3 by 0.5mil ribbons on input and output.



## GaAs HEMT MMIC MEDIUM POWER AMPLIFIER, 71 - 86 GHz

### Mounting & Bonding Techniques for Millimeterwave GaAs MMICs

The die should be attached directly to the ground plane eutectically or with conductive epoxy (see HMC general Handling, Mounting, Bonding Note).

50 Ohm Microstrip transmission lines on 0.127mm (5 mil) thick alumina thin film substrates are recommended for bringing RF to and from the chip (Figure 1). If 0.254mm (10 mil) thick alumina thin film substrates must be used, the die should be raised 0.150mm (6 mils) so that the surface of the die is coplanar with the surface of the substrate. One way to accomplish this is to attach the 0.102mm (4 mil) thick die to a 0.150mm (6 mil) thick molybdenum heat spreader (moly-tab) which is then attached to the ground plane (Figure 2).

Microstrip substrates should be placed as close to the die as possible in order to minimize bond wire length. Typical die-to-substrate spacing is 0.076mm to 0.152 mm (3 to 6 mils).

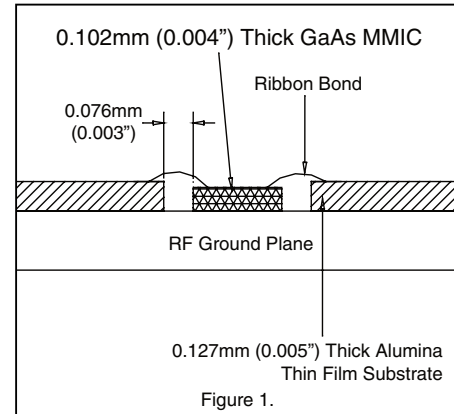

### Handling Precautions

Follow these precautions to avoid permanent damage.

**Storage:** All bare die are placed in either Waffle or Gel based ESD protective containers, and then sealed in an ESD protective bag for shipment. Once the sealed ESD protective bag has been opened, all die should be stored in a dry nitrogen environment.

**Cleanliness:** Handle the chips in a clean environment. DO NOT attempt to clean the chip using liquid cleaning systems.

**Static Sensitivity:** Follow ESD precautions to protect against ESD strikes.

**Transients:** Suppress instrument and bias supply transients while bias is applied. Use shielded signal and bias cables to minimize inductive pick-up.

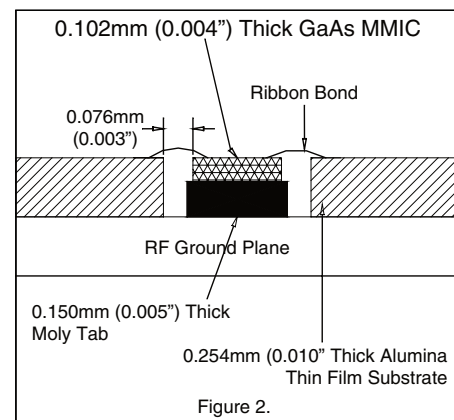

**General Handling:** Handle the chip along the edges with a vacuum collet or with a sharp pair of bent tweezers. The surface of the chip may have fragile air bridges and should not be touched with vacuum collet, tweezers, or fingers.

### Mounting

The chip is back-metallized and can be die mounted with AuSn eutectic preforms or with electrically conductive epoxy. The mounting surface should be clean and flat.

**Eutectic Die Attach:** A 80/20 gold tin preform is recommended with a work surface temperature of 255 °C and a tool temperature of 265 °C. When hot 90/10 nitrogen/hydrogen gas is applied, tool tip temperature should be 290 °C. DO NOT expose the chip to a temperature greater than 320 °C for more than 20 seconds. No more than 3 seconds of scrubbing should be required for attachment.

**Epoxy Die Attach:** Apply a minimum amount of epoxy to the mounting surface so that a thin epoxy fillet is observed around the perimeter of the chip once it is placed into position. Cure epoxy per the manufacturer's schedule.

### Wire Bonding

RF bonds made with 0.003" x 0.0005" ribbon are recommended. These bonds should be thermosonically bonded with a force of 40-60 grams. DC bonds of 0.001" (0.025 mm) diameter, thermosonically bonded, are recommended. Ball bonds should be made with a force of 40-50 grams and wedge bonds at 18-22 grams. All bonds should be made with a nominal stage temperature of 150 °C. A minimum amount of ultrasonic energy should be applied to achieve reliable bonds. All bonds should be as short as possible, less than 12 mils (0.31 mm).

## Looking for pricing, stock, or lifecycle information?

Click below to explore more details on WIN SOURCE:

- ⊖ [View HMC-AUH320-SX on WIN SOURCE](#)
- ⊖ [Analog Devices Inc. Information](#)

## Optimize Your Supply Chain with WIN SOURCE Solutions

- ✓ Global Sourcing Solution
- ✓ Obsolete Management
- ✓ Cost Control Management
- ✓ Shortage Management
- ✓ Alternative Solution
- ✓ Excess Inventory Management