

Product Overview

The QPL1240 is an ultra-linear GaAs pHEMT 75-Ohm differential amplifier IC with 5–1218 MHz operating bandwidth. This amplifier provides 17.9 dB of gain and very low noise figure. The Differential push-pull topology provides excellent 2nd order intermodulation performance. The QPL1240 can be used as a low noise balanced amp in DOCSIS downstream, as well as upstream applications, due to its wide operational bandwidth. The QPL1240 is packaged in a SOIC-8 plastic package.



8-Pin SOIC Package

Functional Block Diagram

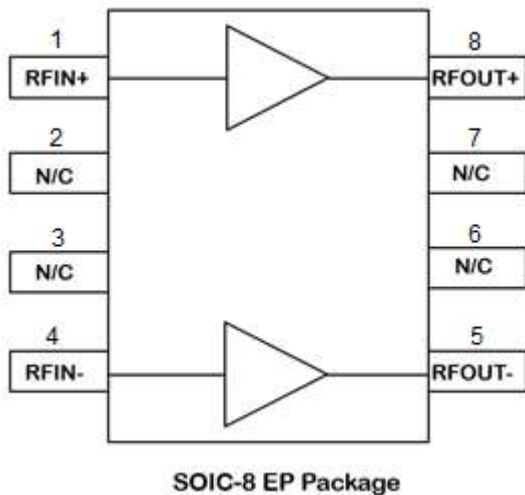

Key Features

- High Gain: 17.9 dB at 1218 MHz
- 5 – 1218 MHz BW
- OIP3: +42.5 dBm, Downstream 50 – 1218 MHz
- OP1dB: 26.6 dBm, Downstream 50 – 1218 MHz
- Low Noise Figure: < 2.6 dB, Downstream
- Excellent Composite Distortion
- pHEMT GaAs device technologies
- Compact Size: 8-pin SOIC
- 5 to 8V supply voltage operation

Ordering Information

Part Number	Description
QPL1240SB	Sample bag with 5 pieces
QPL1240SR	7" Reel with 100 pieces
QPL1240TR13	13" Reel with 2500 pieces
QPL1240EVB-01	5V, 50 – 1218 MHz Eval Board
QPL1240EVB-02	5V, 5 – 700 MHz Eval Board
QPL1240EVB-03	8V, 50 – 1218 MHz Eval Board
QPL1240EVB-04	8V, 5 – 700 MHz Eval Board

Applications

- DOCSIS 3.1 Systems
- Balanced Antenna Applications
- HFC Optical Nodes
- 75 Ω Amplifiers
- Upstream Amplifier for DOCSIS 3.1 and DOCSIS 4.0 Applications

Absolute Maximum Ratings

Parameter	Rating
Supply Voltage (V _{DD})	+10 V
Supply Current (I _{DD})	400 mA
Maximum Input Level	+15 dBm
Operating Case Temperature Range	-40 to +100 °C
Storage Temperature Range	-40 to +150 °C
Maximum Junction Temperature	+150 °C

Exceeding any one or a combination of the Absolute Maximum Rating conditions may cause permanent damage to the device. Extended application of Absolute Maximum Rating conditions to the device may reduce device reliability.

Electrical Specifications for Downstream (50-1218MHz)

Parameter	Condition ⁽¹⁾	Min	Typ	Max	Unit
Supply Voltage (V _{DD})			5 / 8		V
Supply Current (I _{DD})	V _{DD} total current		275/330		mA
Frequency Range		50		1218	MHz
Gain	50 – 1218 MHz		17.9		dB
Gain Flatness	50 – 1218 MHz		±0.5		dB
Input Return Loss	50 – 1218 MHz		20		dB
Output Return Loss	50 – 1218 MHz		20		dB
Noise Figure	50 MHz 1218 MHz		1.7 2.6		dB
CSO	79 Ch + QAM to 1 GHz, +39dBmV / Ch, 0dB tilt, Downstream		82		dBc
CTB			67		dBc
OIP2	13 dBm / tone, Δf = 53 MHz, 50-1218 MHz		68		dBm
OIP3	13 dBm / tone, Δf = 6 MHz, 50-1218 MHz		43		dBm
Output P1dB	50 – 1218 MHz		27		dBm
Thermal Resistance	Junction to case		20		°C/W

Notes:

1. Typical performance at these conditions: Temp = +25 °C, V_{DD} = +5V, 75 Ω system, Full band unless otherwise noted.
2. Downstream (Forward Path) Freq Range is 50-1218 MHz

Evaluation Board Schematic for Downstream (5V, 50 – 1218MHz)

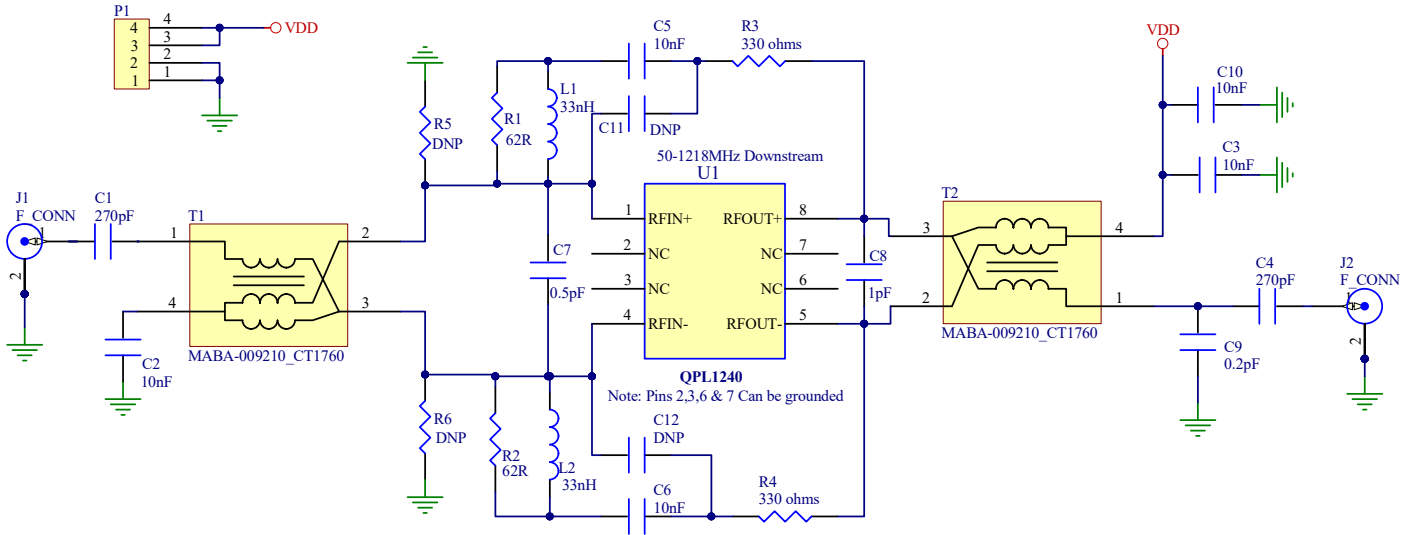

Bill of Material for Downstream (5V, 50 – 1218MHz)

Reference Designator	Description	Manufacturer	Part Number
U1	1218 MHz, 19 dB Push-Pull Amp	Qorvo	QPL1240SB
PCB	EVB PCB, QPL1163/1240	Qorvo	SAP # 302353
C1, C4	CAP, 270 pF, 5 %, 0402	Murata	GCM1555C1H271JA16D
C2, C3, C5, C6, C10	CAP, 0.01 uF, 5 %, 50 V, 0402	Murata	GRM155R11H103JA88
C8	CAP, 1pF, +/-0.05pF, 50V, HI-Q, 0402	Murata	GJM1555C1H1R0WB01D
C9	CAP, 0.2pF, +/-0.1pF, 50V, HI-Q, 0402	Murata	GJM1555C1HR20BB01D
C7	CAP, 0.5pF, +/-0.25pF, 50V, HI-Q, 0402	Murata	GJM1555C1HR50CB01D
R1, R2	RES, 62 OHM, 5%, 1/16W, 0402	Kamaya	RMC1/16S-620JTH
L1, L2	IND, 33nH, 5%, M/L, 0402	Murata	LQG15HN33NJ02D
R3, R4	RES, 330 OHM, 5%, 1/16W, 0402	Kamaya	RMC1/16S-331JTH
T1, T2	BALUN, 1:1	MACOM	MABA-009210-CT1760
T1, T2 (Alternate vendor)	BALUN, 1:1	Mini-RF	MRFXF0072
P1	CONN, HDR	Samtec	TSW-103-07-G-S
J1, J2	CONN, F FEM, 75OHM	Millimeter Wave	MW-846-C-DD-75
Heatsink	HEATSINK, 50 x 50 x10, ALUMINUM	Alpha Nova Tech	S08EFV05-A
C11, C12, R5, R6	DNP		

- For 8V operation, populate R5 & R6 with 12K Ohm Resistors

Evaluation Board Layout

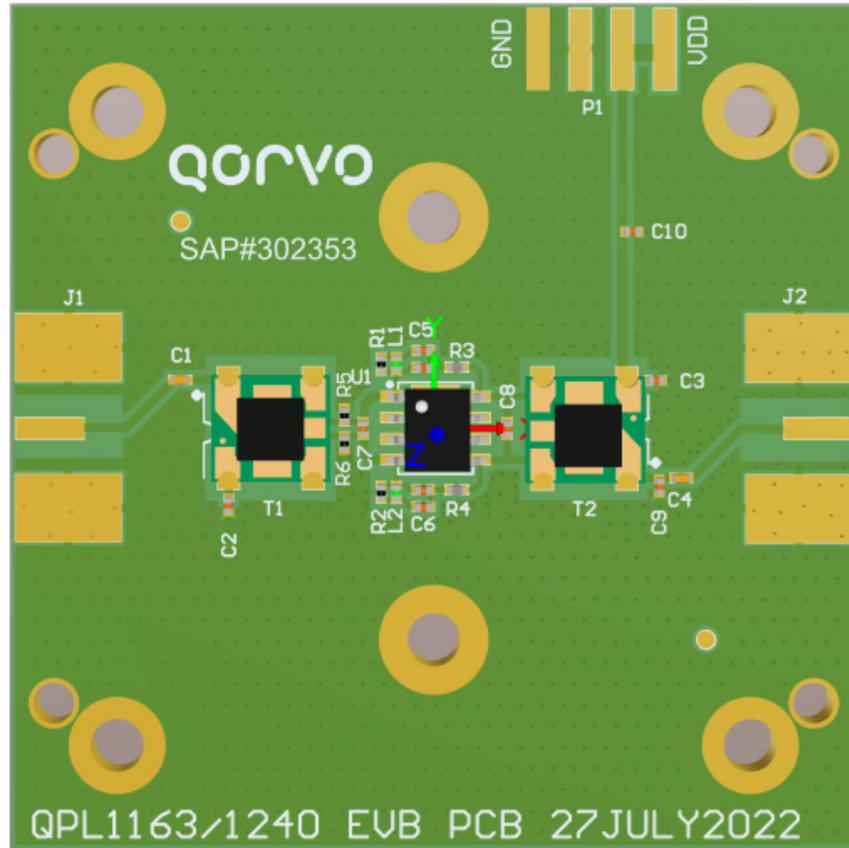

LAYER STACK LEGEND

Material	Layer	Thickness	Dielectric Material	Type	Comment
	Top Overlay			Legend	HIGH TEMPERATURE, NON-CONDUCTIVE, WHITE EPOXY BASED INK.
Surface Material	Top Solder	0.0004in	Solder Resist	Solder Mask	LPI (LIQUID PHOTO-IMAGEABLE), OR LDI (LASER DIRECT IMAGEABLE), GREEN. MAX FINISH THICKNESS TO BE 0.001in.
Copper	Top Layer	0.0014in		Signal	
		0.0580in	FR-4	Dielectric	
Copper	Bottom Layer	0.0014in		Signal	
Surface Material	Bottom Solder	0.0004in	Solder Resist	Solder Mask	
	Bottom Overlay			Legend	

Performance Data for Downstream (5V, 50-1218 MHz)

Test conditions unless otherwise noted: Vdd = +5V, Temp = +25C, Zo = 75Ω

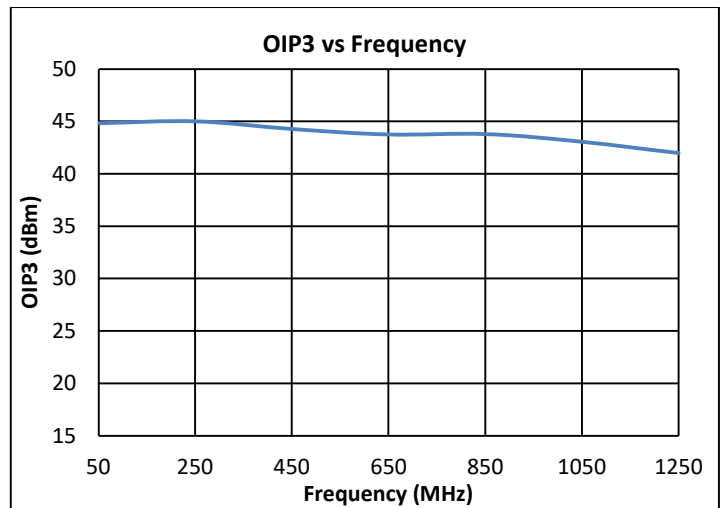
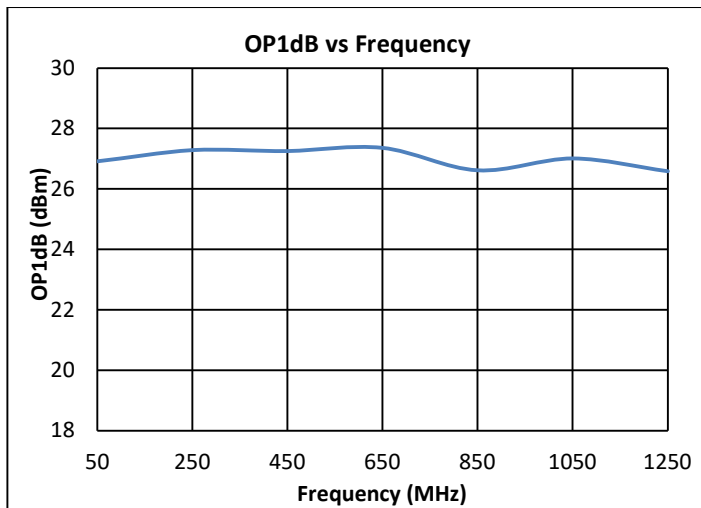
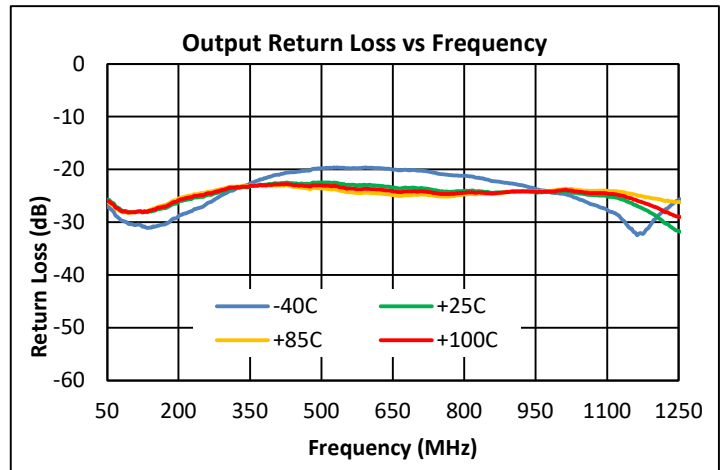
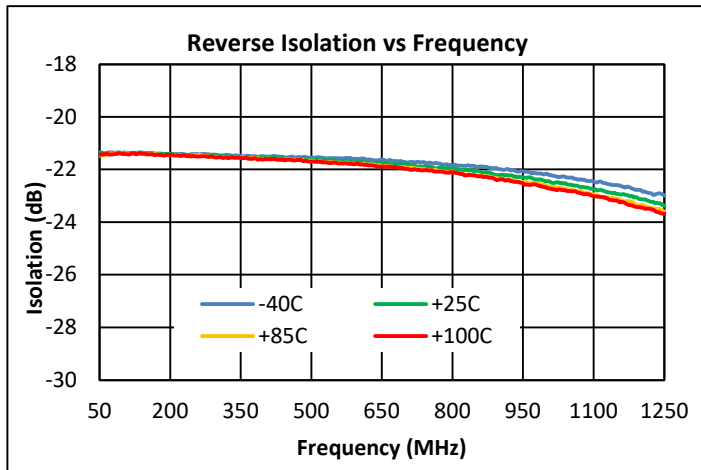
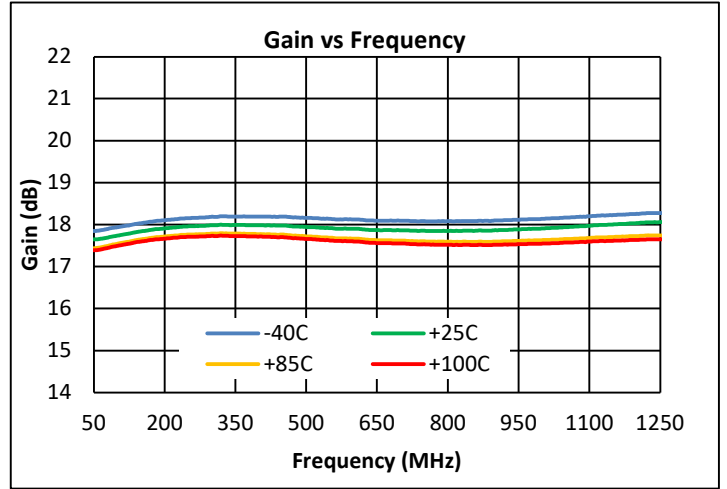
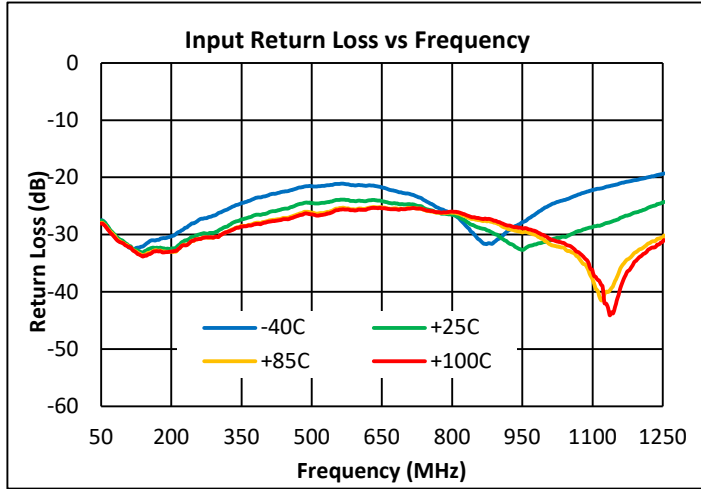

Note: OIP3: +13 dBm / tone output, Δf = 6 MHz, 50-1218 MHz

Performance Data for Downstream (5V, 50-1218 MHz)

Test conditions unless otherwise noted: V_{dd} = +5V, Temp = +25C, Z_o = 75Ω

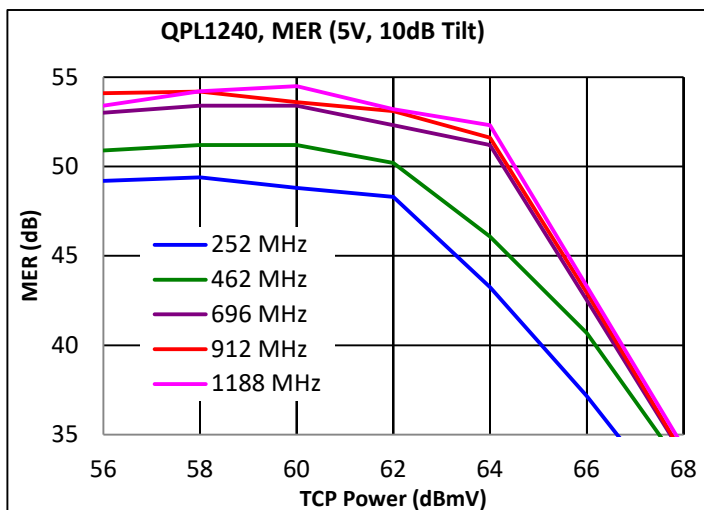
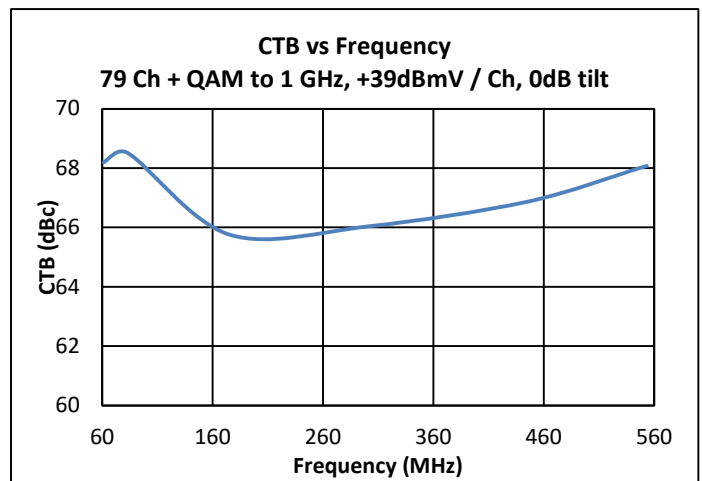
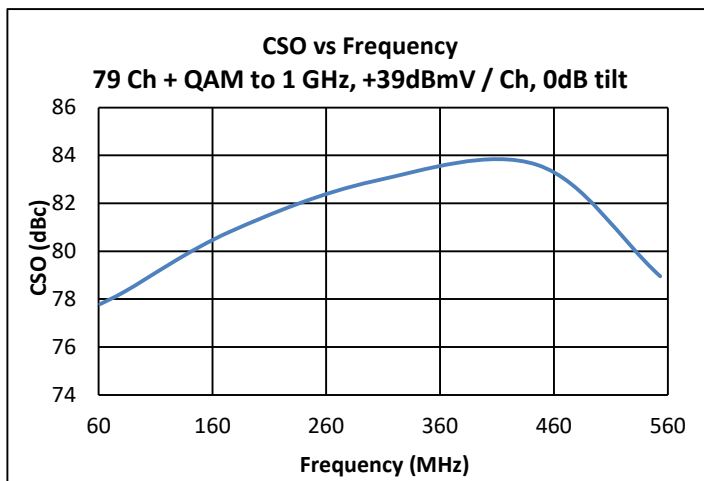
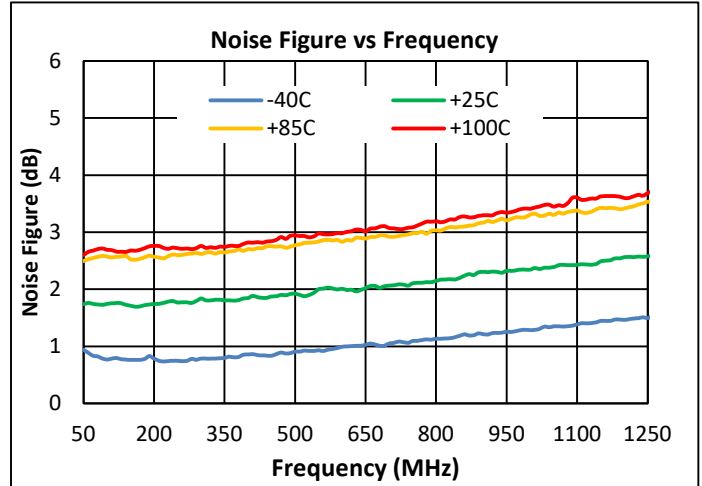
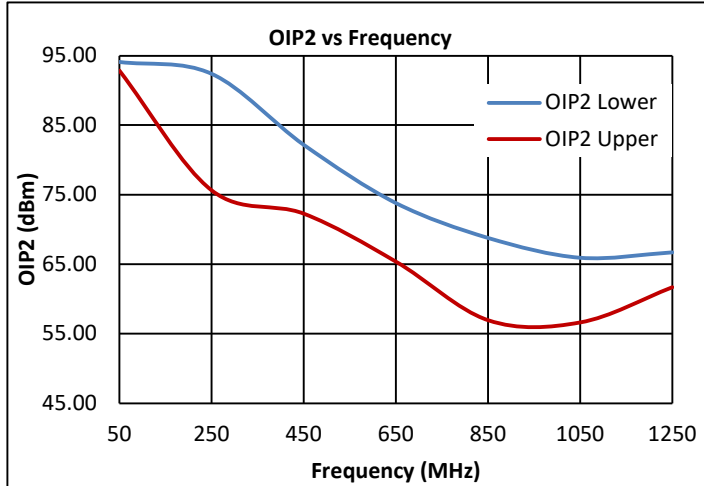

Notes: 1. OIP2: +13 dBm / tone output, Δf = 53 MHz, 50-1218 MHz

2. MER data is source corrected, 10dB Tilt

Performance Data for Downstream (8V, 50-1218 MHz)

Test conditions unless otherwise noted: V_{dd} = +8V, Temp = +25C, Z_o = 75Ω

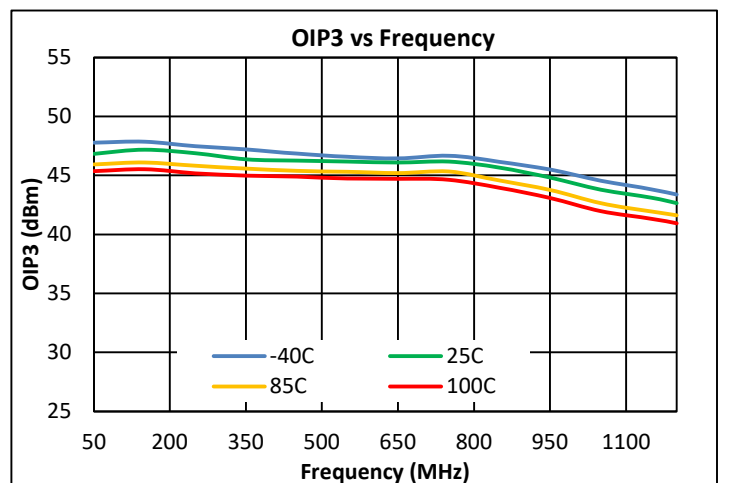
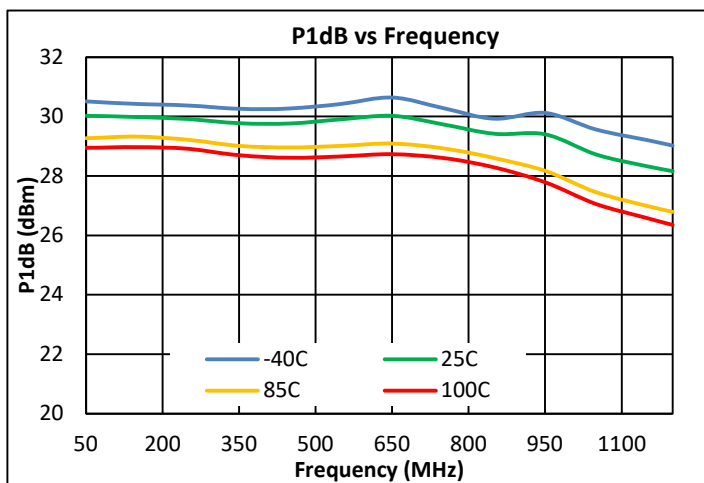
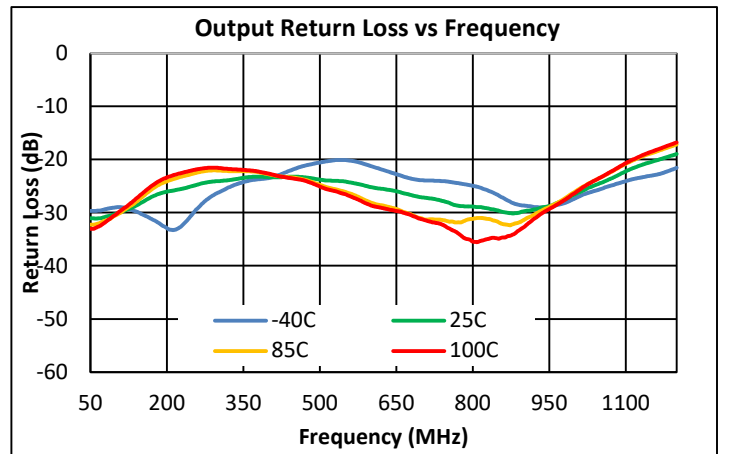
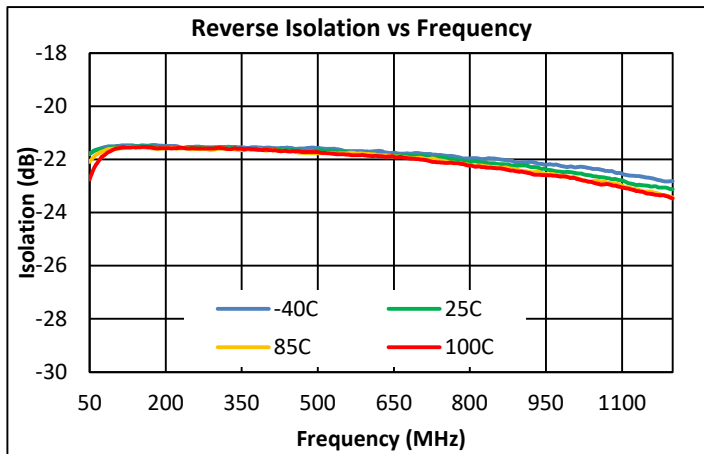
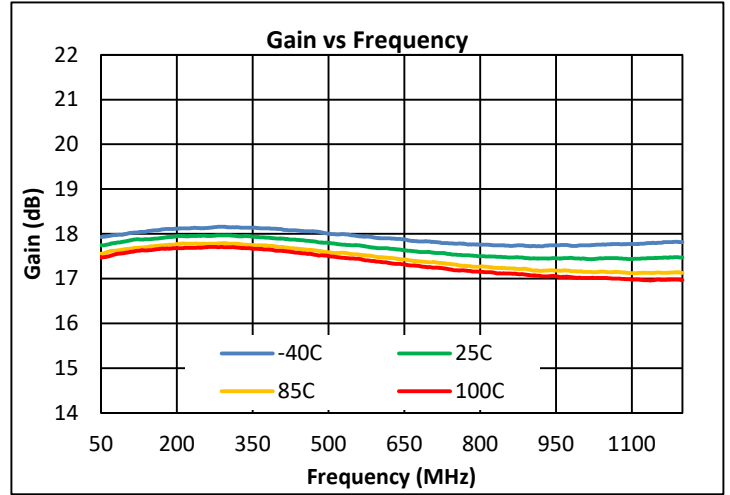
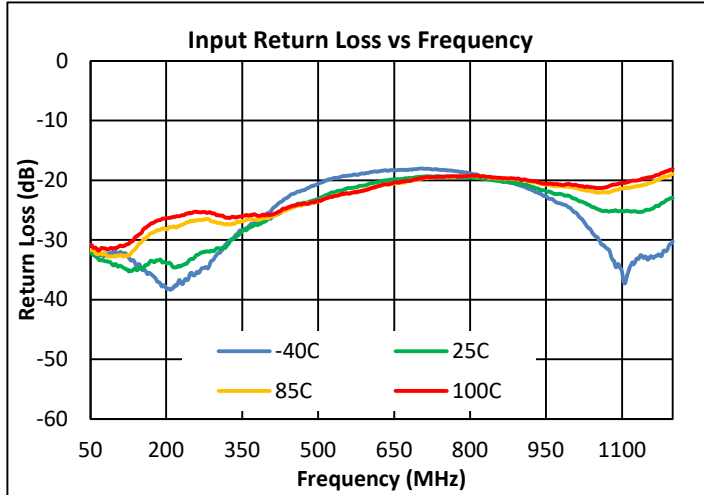

Notes: 1. OIP3 +13dBm / tone output. Δf = 6 MHz, 50-1218 MHz

Performance Data for Downstream (8V, 50-1218 MHz)

Test conditions unless otherwise noted: V_{dd} = +8V, Temp = +25C, Z_o = 75Ω

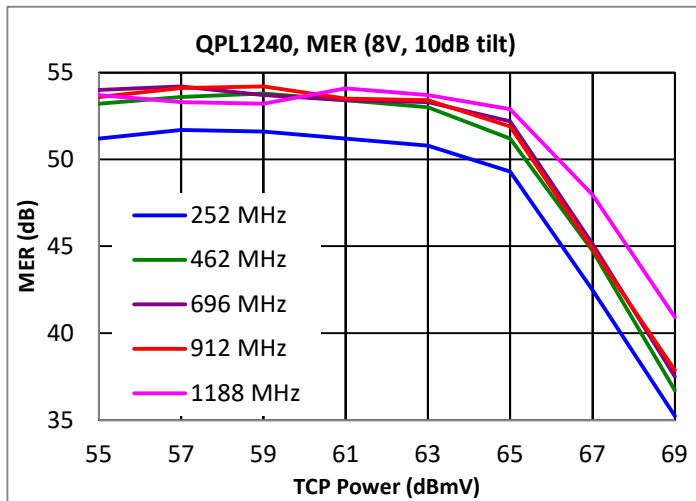
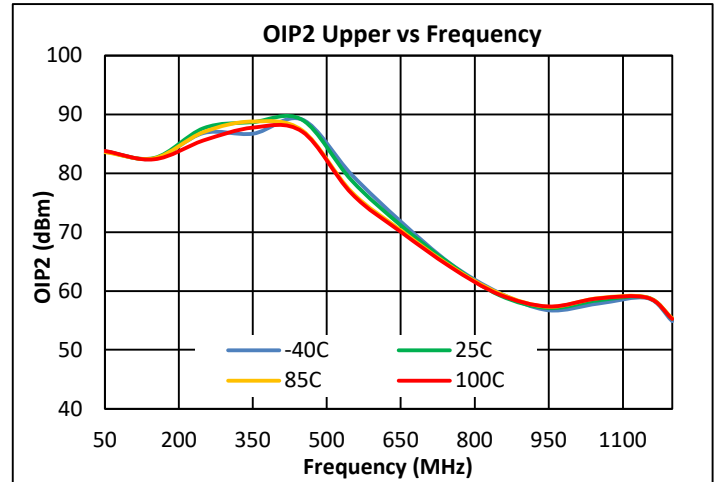
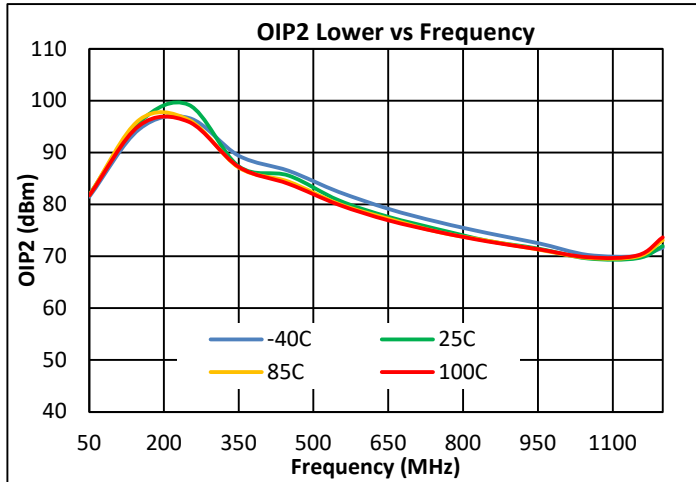

Notes: 1. OIP2: +13 dBm / tone output, Δf = 53 MHz, 50-1218 MHz

2. MER data is source corrected, 10dB Tilt

Evaluation Board Schematic for Upstream (5V, 5 – 300MHz)

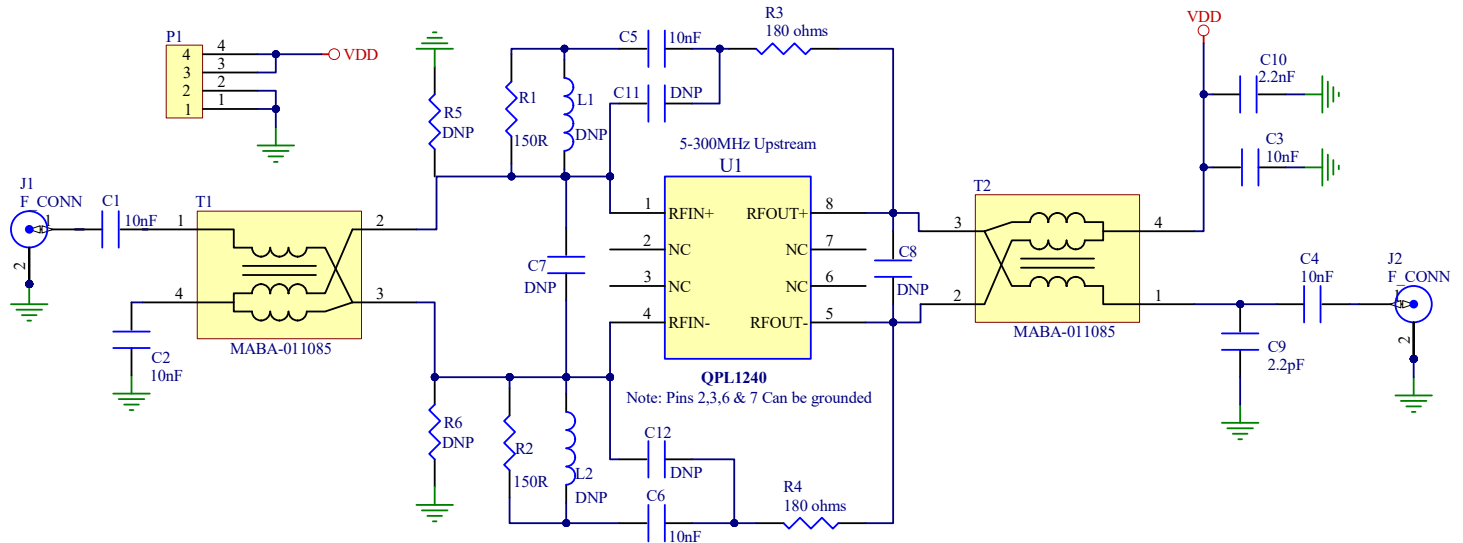

Bill of Material for Upstream (5V, 5 – 300MHz)

Reference Designator	Description	Manufacturer	Part Number
U1	1218 MHz, 19 dB Push-Pull Amp	Qorvo	QPL1240SB
PCB	EVB PCB, QPL1163/1240	Qorvo	SAP # 302353
C1, C2, C3, C4, C5, C6	CAP, 0.01uF, 5%, 50 V, 0402	Murata	GRM155R11H103JA88
C10	CAP, 2.2nF, 5%, 50V, 0402	Murata	GRM155R11H222JA01
C9	CAP, 2.2pF, +/-0.1pF, 50V, HI-Q, 0402	Murata	GRM0223C1H2R2BA0
R1, R2	RES, 150 OHM, 5%, 1/16W, 0402	Kamaya	RMC1/16S-151JTH
R3, R4	RES, 180 OHM, 5%, 1/16W, 0402	Kamaya	RMC1/16S-181JTH
T1, T2	BALUN, 1:1	MACOM	MABA-0011085
T1, T2 (Alternate vendor)	BALUN, 1:1	Mini-RF	MRFXF5R09
P1	CONN, HDR	Samtec	TSW-103-07-G-S
J1, J2	CONN, F FEM, 75OHM	Millimeter Wave	MW-846-C-DD-75
Heatsink	HEATSINK, 50 x 50 x10, ALUMINUM	Alpha Nova Tech	S08EFV05-A
L1, L2, C7, C8, C11, C12, R5, R6	DNP		

- For 8V operation, populate R5 & R6 with 12K Ohm Resistors

Performance Data for Upstream (5V, 5-300 MHz)

Test conditions unless otherwise noted: V_{dd} = +5V, Temp = +25C, Z_o = 75Ω

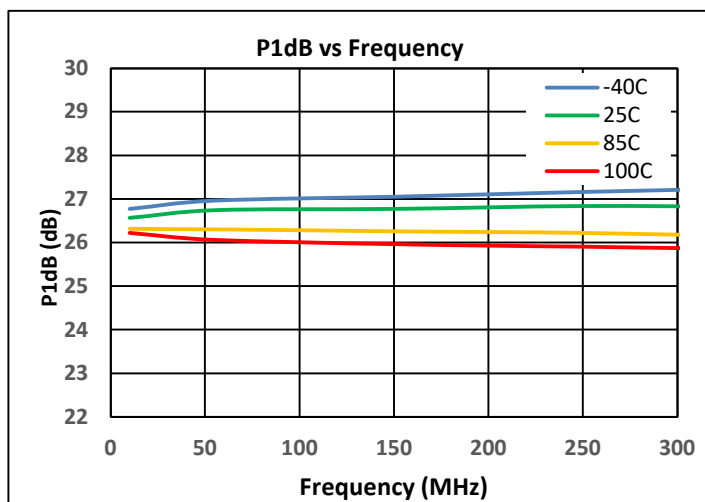
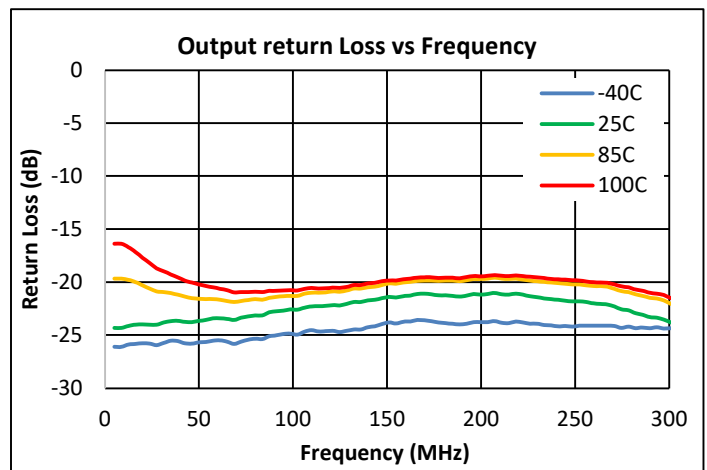
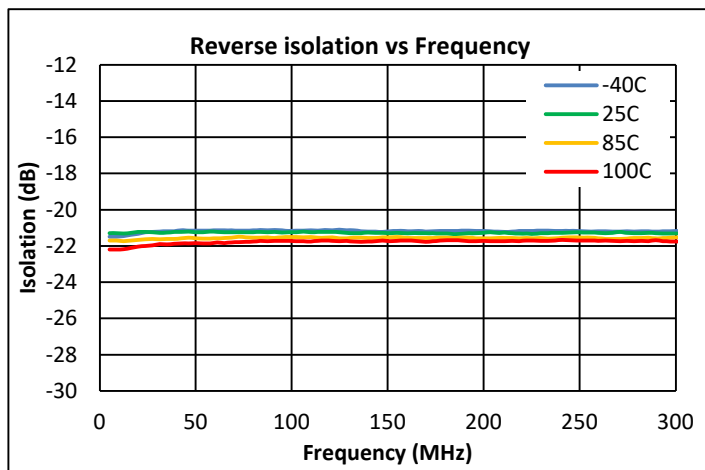
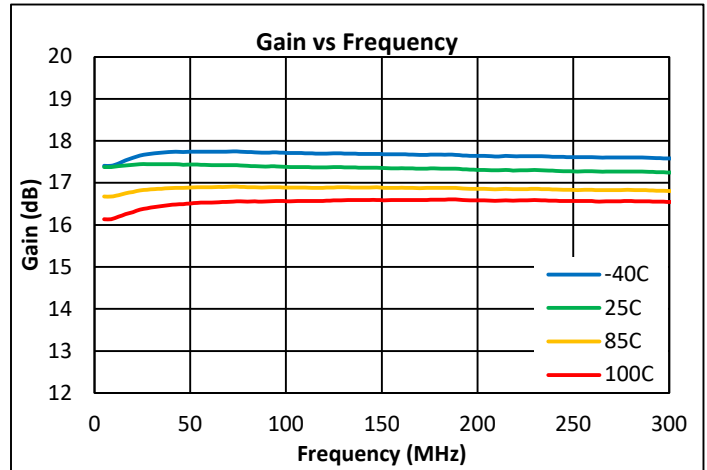
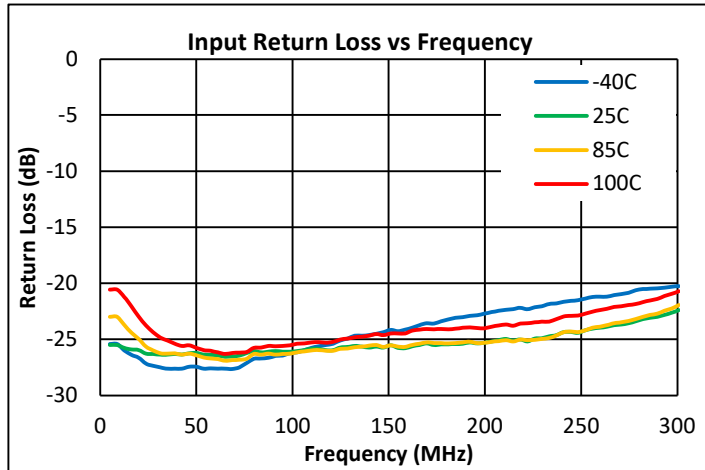

Performance Data for Upstream (5V, 5-300 MHz)

Test conditions unless otherwise noted: Vdd = +5V, Temp = +25C, Zo = 75 Ω

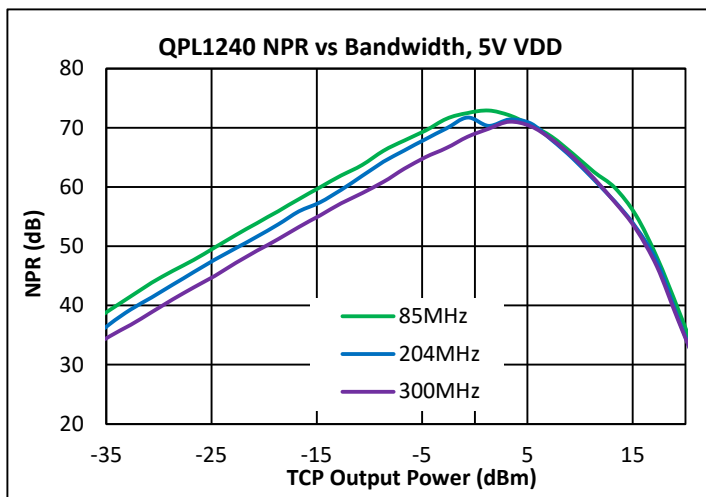
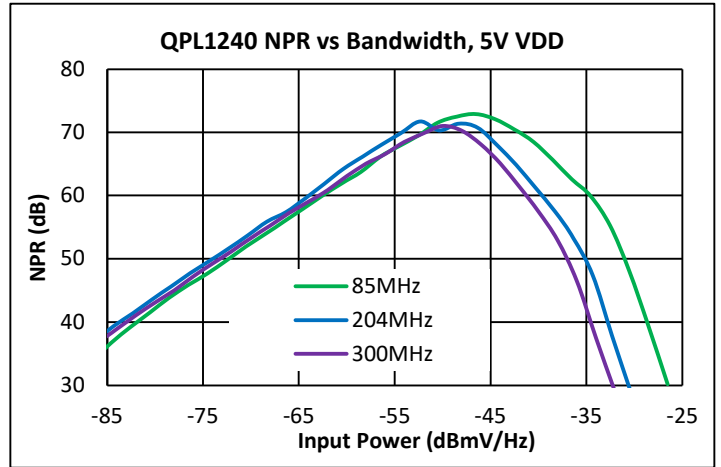
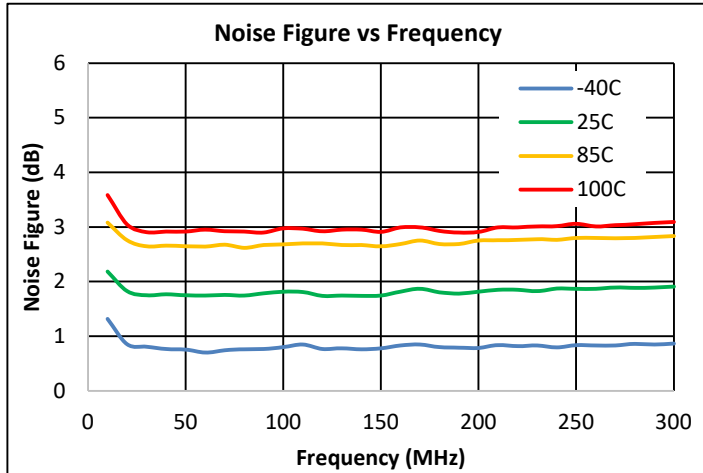

Electrical Specifications for Upstream (5V, 5-700MHz)

Parameter	Condition ⁽¹⁾	Min	Typ	Max	Unit
Supply Voltage (V_{DD})			5		V
Supply Current (I_{DD})	V_{DD} total current		275		mA
Frequency Range		5		700	MHz
Gain	5 – 700 MHz		17.8		dB
Gain Flatness	5 – 700 MHz		0.25		dB
Input Return Loss	5 – 700 MHz		18		dB
Output Return Loss	5 – 700 MHz		18		dB
Noise Figure	5 – 700 MHz		2		dB
Output P1dB	5 – 700 MHz		27		dBm
Thermal Resistance	Junction to case		20		$^{\circ}\text{C/W}$

Notes:

1. Typical performance at these conditions: Temp = +25 $^{\circ}\text{C}$, V_{DD} = +5V, 75 Ω system, Full band unless otherwise noted.
2. Upstream (Reverse Path) Freq Range is 5-700 MHz

Electrical Specifications for Upstream (8V, 5-700MHz)

Parameter	Condition ⁽¹⁾	Min	Typ	Max	Unit
Supply Voltage (V_{DD})			8		V
Supply Current (I_{DD})	V_{DD} total current		330		mA
Frequency Range		5		700	MHz
Gain	5 – 700 MHz		17.8		dB
Gain Flatness	5 – 700 MHz		0.25		dB
Input Return Loss	5 – 700 MHz		18		dB
Output Return Loss	5 – 700 MHz		18		dB
Noise Figure	5 – 700 MHz		2		dB
Output P1dB	5 – 700 MHz		27		dBm
Thermal Resistance	Junction to case		20		$^{\circ}\text{C/W}$

Notes:

1. Typical performance at these conditions: Temp = +25 $^{\circ}\text{C}$, V_{DD} = +8V, 75 Ω system, Full band unless otherwise noted.
2. Upstream (Reverse Path) Freq Range is 5-700 MHz

Evaluation Board Schematic for Upstream (5V, 5 – 700MHz)

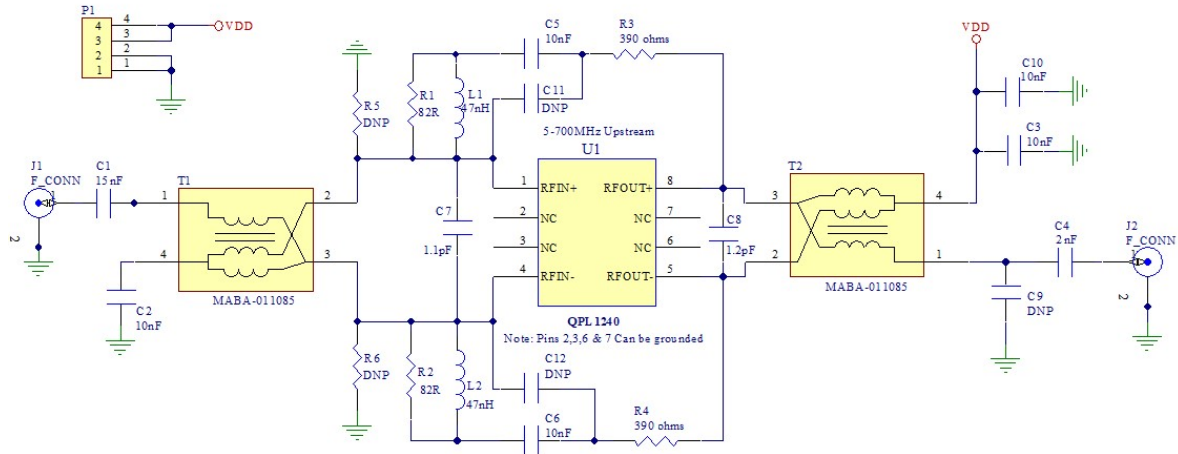

Bill of Material for Upstream (5V, 5 – 700MHz)

Reference Designator	Description	Manufacturer	Part Number
U1	1218 MHz, 19 dB Push-Pull Amp	Qorvo	QPL1240SB
PCB	EVB PCB, QPL1163/1240	Qorvo	SAP # 302353
C1, C2, C3, C4, C5, C6, C10	CAP, 0.01uF, 5%, 50 V, 0402	Murata	GRM155R11H103JA88
C7	CAP, 1.1pF, +/-0.25pF, 50V, Hi-Q,0402	Murata	GJM1555C1H1R1CB01D
C8	CAP, 1.2pF, +/-0.25pF, 50V, Hi-Q,0402	Murata	GJM1555C1H1R2CB01D
R1, R2	RES, 82 OHM, 5%, 1/16W, 0402	Kamaya	RMC1/16S-820JTH
R3, R4	RES, 390 OHM, 5%, 1/16W, 0402	Kamaya	RMC1/16S-391JTH
T1, T2	BALUN, 1:1	MACOM	MABA-0011085
L1, L2	IND 47nH, 5%, M/L, 0402	Murata	LQG15HN47NJ02D
P1	CONN, HDR	Samtec	TSW-103-07-G-S
J1, J2	CONN, F FEM, 75OHM	Millimeter Wave	MW-846-C-DD-75
Heatsink	HEATSINK, 50 x 50 x10, ALUMINUM	Alpha Nova Tech	S08EFV05-A
C9, C11, C12, R5, R6	DNP		

- Alternate BALUN: MRFXF5R09

• For 8V operation

R5, R6	RES, 12K OHM, 1%, 1/10W, 0402	KOA peer	RK73H1ETTP1202F
C1	CAP, 15000pF, 10%, 16V, X7R, 0402	Kemet	C0402C153K4RACAUTO
C4	CAP, 2000pF, 5%, 50V, X7R, 0402	AVX	04025C202JAT2A

Performance Data for Upstream (5V, 5-700 MHz)

Test conditions unless otherwise noted: V_{dd} = +5V, Temp = +25C, Z_o = 75Ω

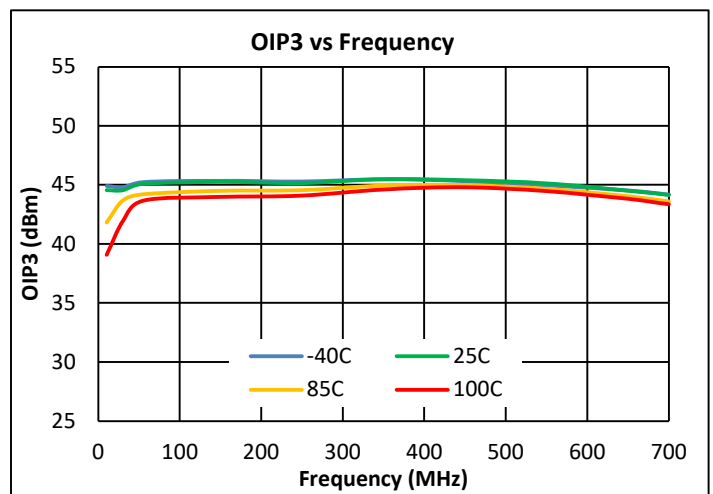
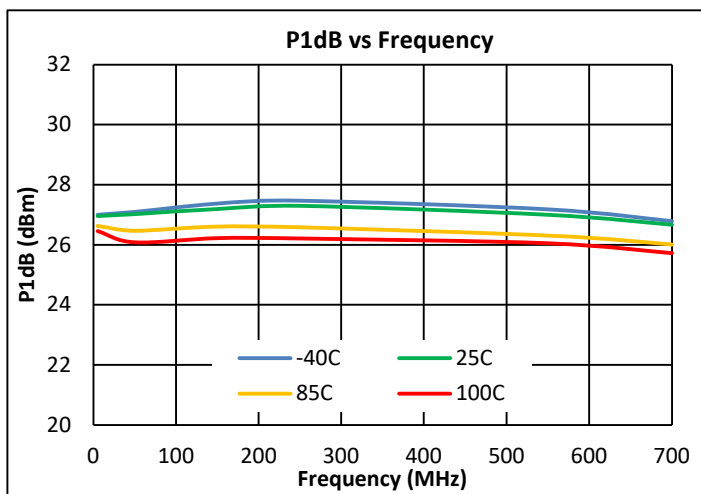
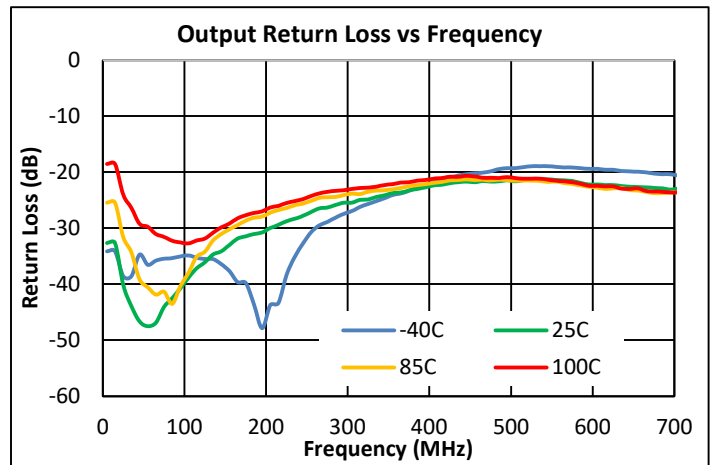
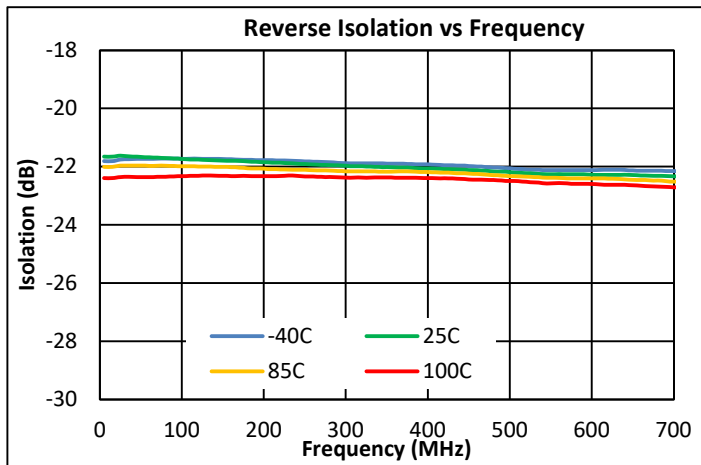
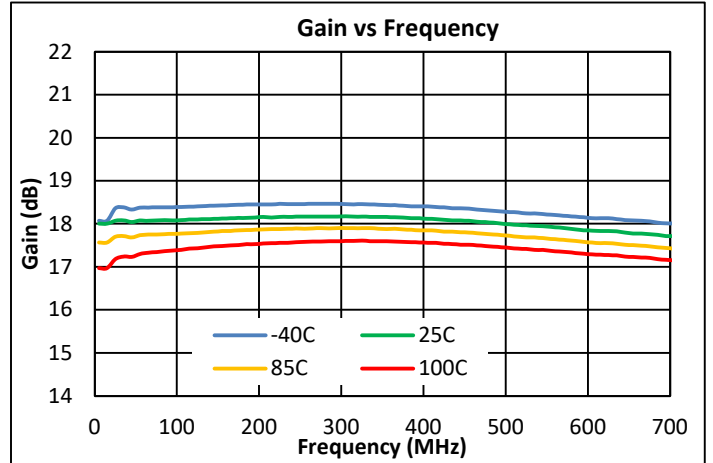
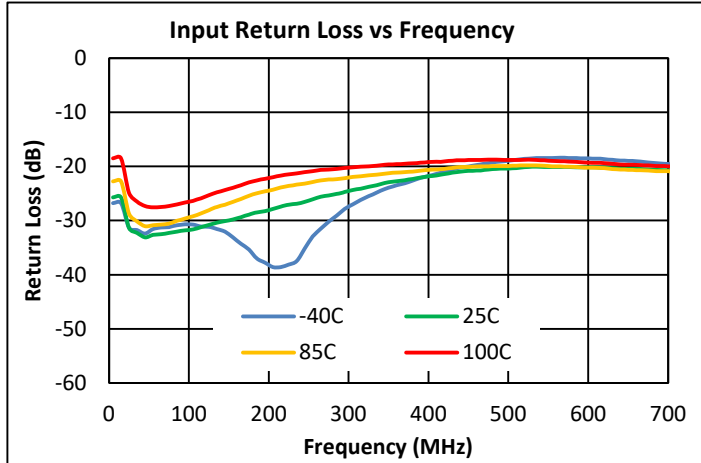

Performance Data for Upstream (5V, 5-700 MHz)

Test conditions unless otherwise noted: Vdd = +5V, Temp = +25C, Zo = 75Ω

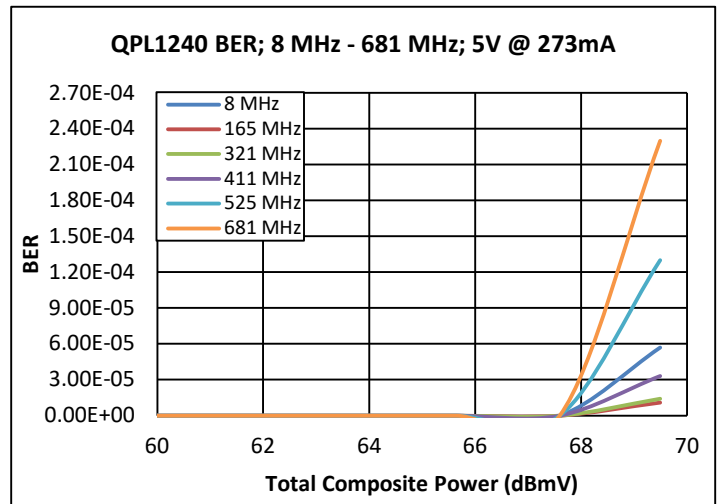
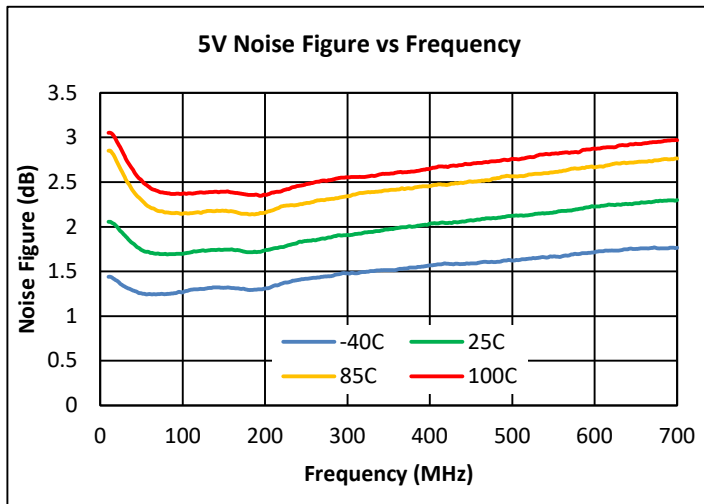
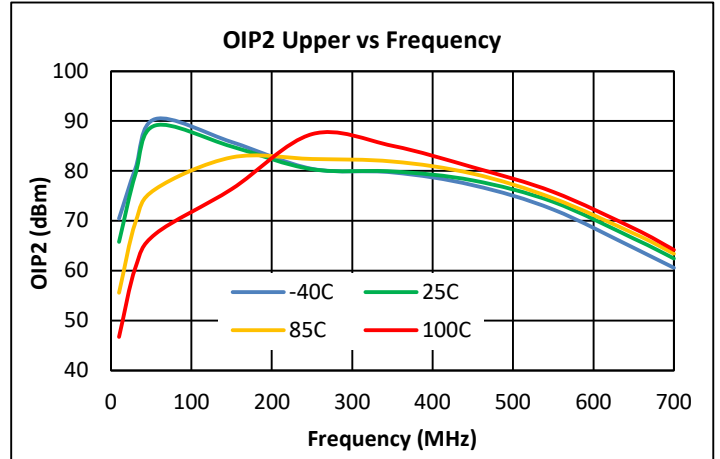
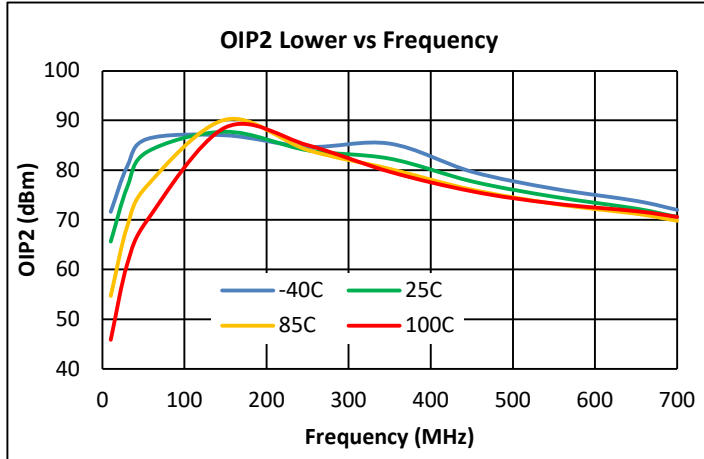

Note:

1. BER data taken with 111 Ch. + QAM and 0dB tilt

Performance Data for Upstream (8V, 5-700 MHz)

Test conditions unless otherwise noted: V_{dd} = +8V, Temp = +25C, Z_o = 75Ω

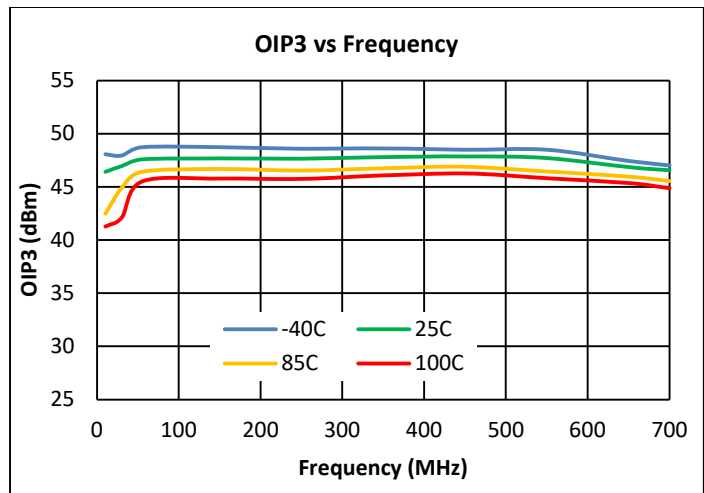
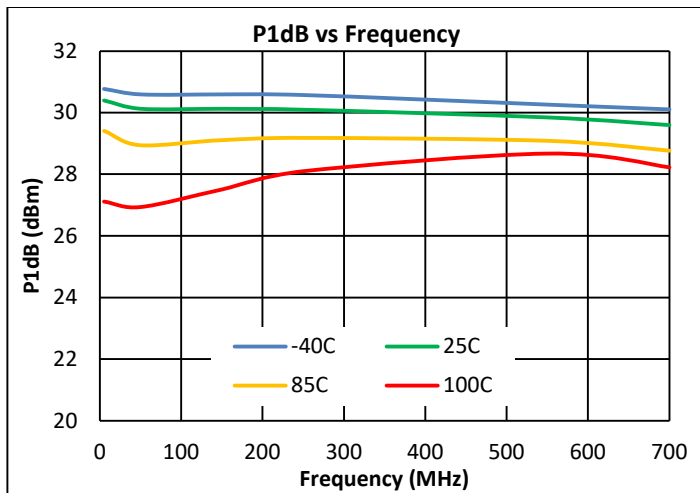
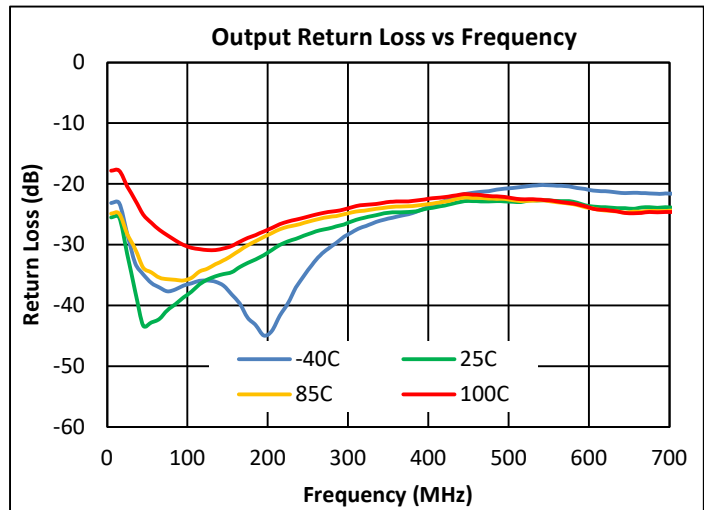
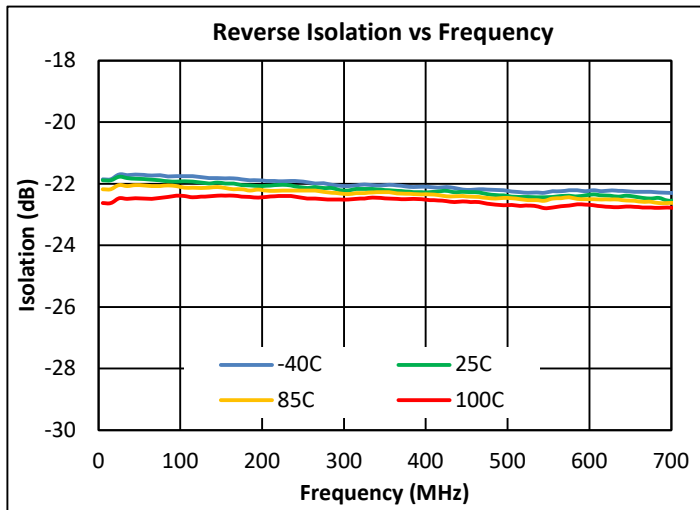
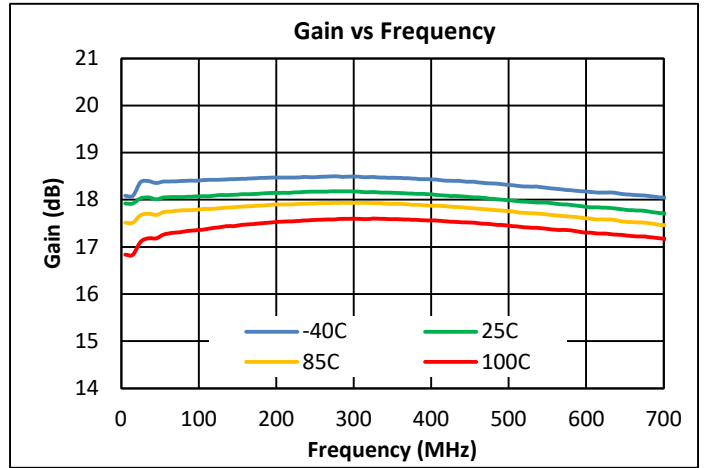
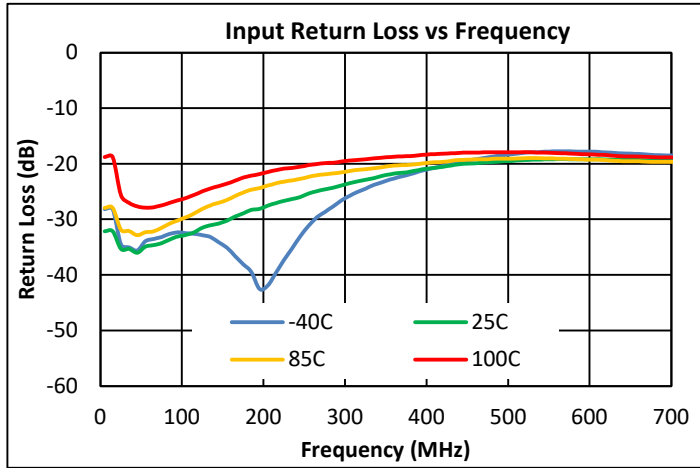

Performance Data for Upstream (8V, 5-700 MHz)

Test conditions unless otherwise noted: V_{dd} = +8V, Temp = +25C, Z_o = 75Ω

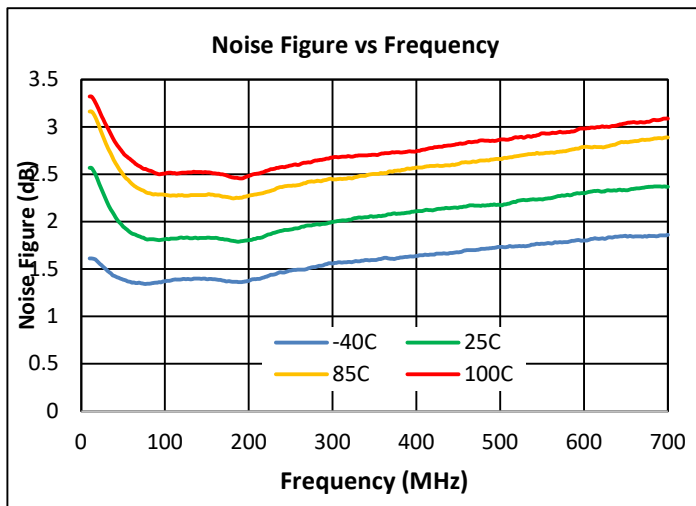
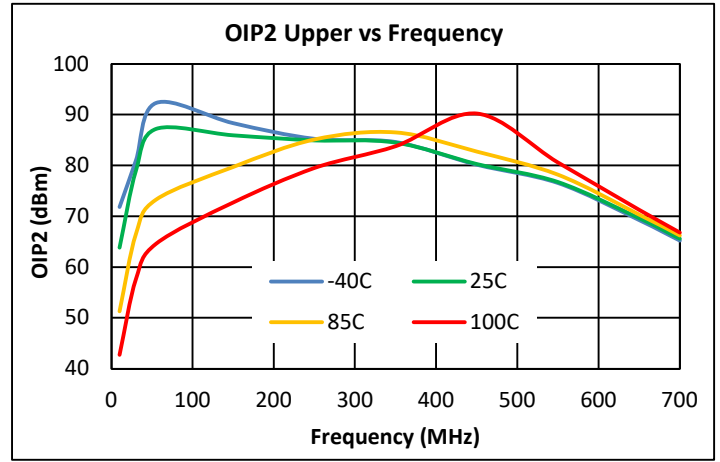
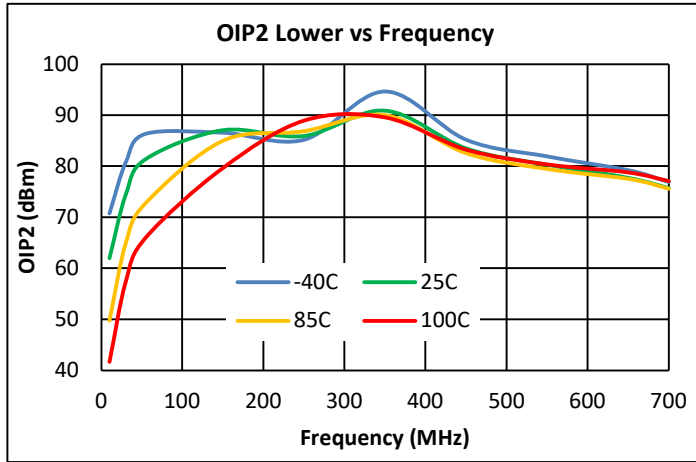

Pin Configuration and Description

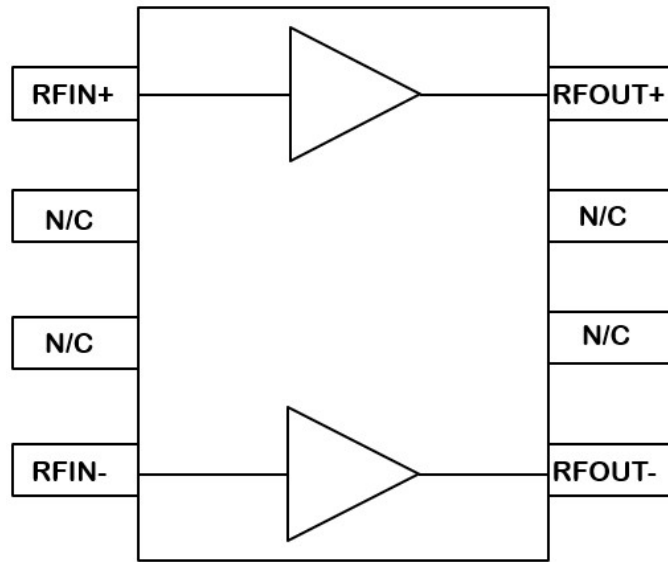

SOIC-8 EP Package

Pin	Name	Description
1	RFIN+	RF input for plus side of amplifier
2	N/C	No Internal Connection - (Pin can be grounded)
3	N/C	No Internal Connection - (Pin can be grounded)
4	RFIN-	RF input for minus side of amplifier
5	RFOUT-	RF output for minus side of amplifier, Vdd (requires bias choke)
6	N/C	No Internal Connection - (Pin can be grounded)
7	N/C	No Internal Connection - (Pin can be grounded)
8	RFOUT+	RF output for plus side of amplifier, Vdd (requires bias choke)
Slug	GND	RF, DC, and Thermal Ground

Package Marking

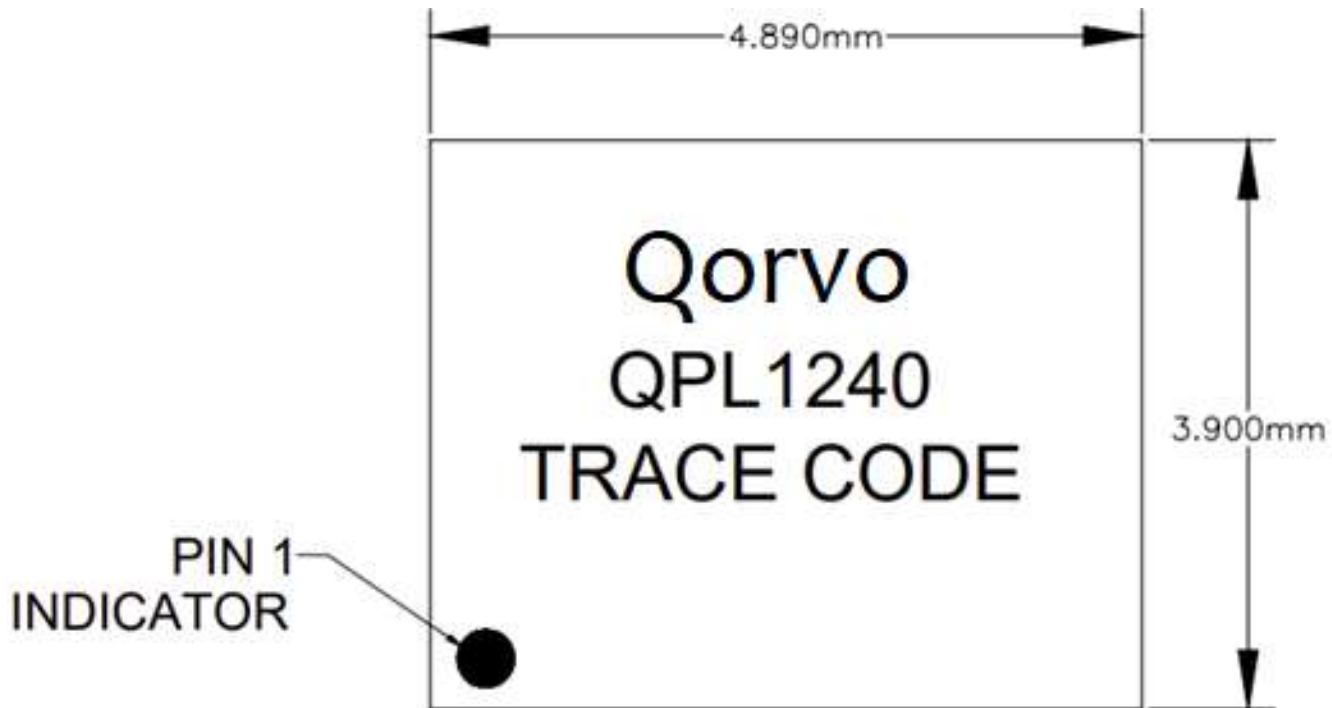

NOTES:

LINE 1: QPL1240

LINE 2: TRACE CODE.

TRACE CODE TO BE
ASSIGNED BY SUBCON.

Tape and Reel

Qorvo Part Number	Reel Diameter Inch (mm)	Hub Diameter Inch (mm)	Width (mm)	Pocket Pitch (mm)	Feed	Units Per Reel
QPL1240	13 (330)	4 (102)	12	8	Single	2500

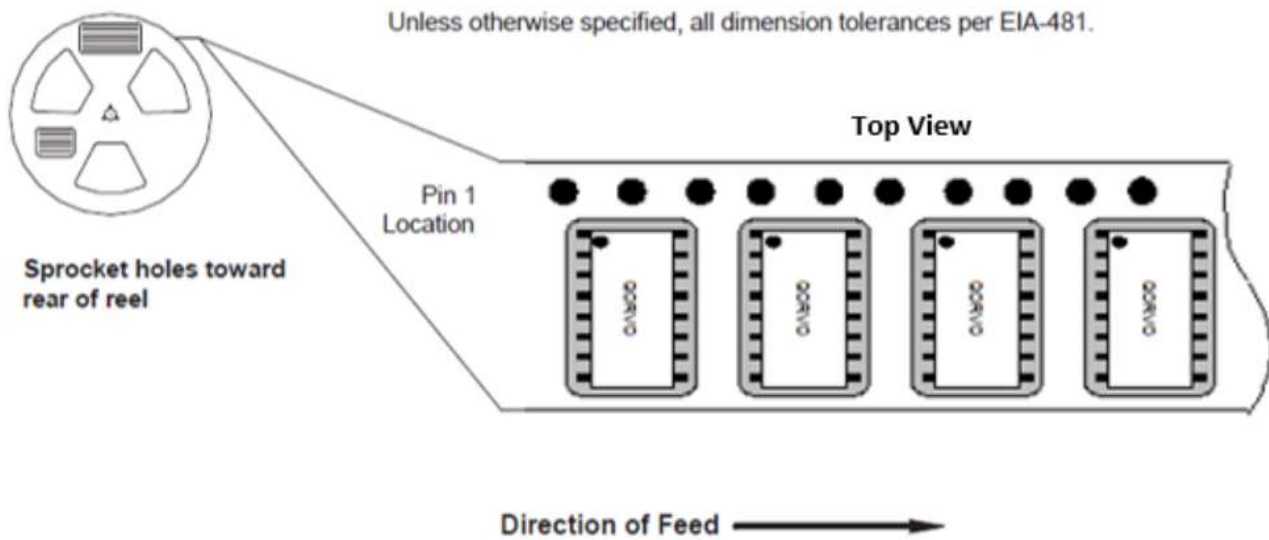

Package Outline

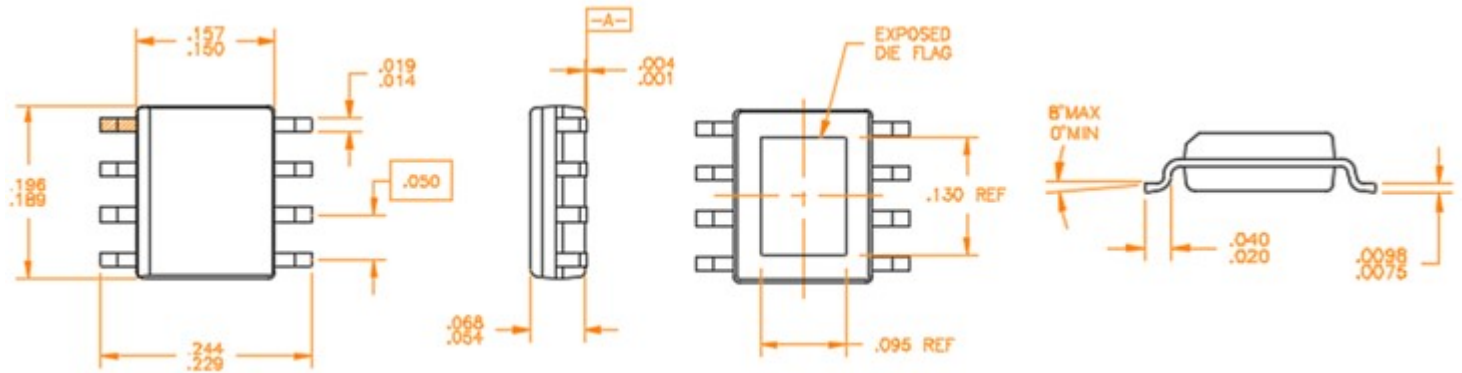

Notes:

1. All Dimensions are in inches.
2. Angles are in degrees.

Recommended PCB Land Pattern

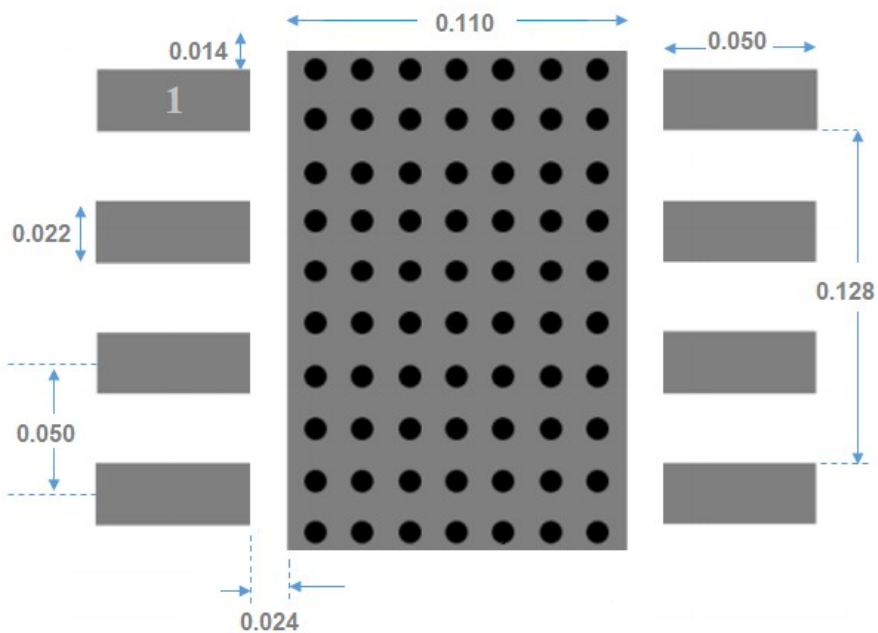

Notes: All dimensions are in inches.

1. Use 1 oz. copper minimum for top and bottom layer metal.
2. Vias are required under the backside paddle for proper RF/DC grounding and thermal dissipation.
3. Recommend about 70 vias of 8mil diameter as shown in the land pattern.

Handling Precautions

Parameter	Rating	Standard
ESD – Human Body Model (HBM)	Class 1B	ESDA/JEDEC JS-001
ESD – Charged Device Model (CDM)	Class C3	ESDA/JEDEC JS-002
MSL – Moisture Sensitivity Level	Level 2	IPC/JEDEC J-STD-020



Caution!
ESD-Sensitive Device

Solderability

Compatible with both lead-free (260 °C max. reflow temp.) and tin/lead (245 °C max. reflow temp.) soldering processes.

Solder profiles available upon request.

Contact plating: Matte Sn

RoHS Compliance

This part is compliant with 2011/65/EU RoHS directive (Restrictions on the Use of Certain Hazardous Substances in Electrical and Electronic Equipment) as amended by Directive 2015/863/EU.

This product also has the following attributes:

- Lead Free
- Halogen Free (Chlorine, Bromine)
- Antimony Free
- TBBP-A (C₁₅H₁₂Br₄O₂) Free
- PFOS Free
- SVHC Free



Contact Information

For the latest specifications, additional product information, worldwide sales and distribution locations:

Tel: **1-844-890-8163**

Web: www.qorvo.com

Email: customer.support@qorvo.com

Important Notice



The information contained herein is believed to be reliable; however, Qorvo makes no warranties regarding the information contained herein and assumes no responsibility or liability whatsoever for the use of the information contained herein. All information contained herein is subject to change without notice. Customers should obtain and verify the latest relevant information before placing orders for Qorvo products. The information contained herein or any use of such information does not grant, explicitly or implicitly, to any party any patent rights, licenses, or any other intellectual property rights, whether with regard to such information itself or anything described by such information. **THIS INFORMATION DOES NOT CONSTITUTE A WARRANTY WITH RESPECT TO THE PRODUCTS DESCRIBED HEREIN, AND QORVO HEREBY DISCLAIMS ANY AND ALL WARRANTIES WITH RESPECT TO SUCH PRODUCTS WHETHER EXPRESS OR IMPLIED BY LAW, COURSE OF DEALING, COURSE OF PERFORMANCE, USAGE OF TRADE OR OTHERWISE, INCLUDING THE IMPLIED WARRANTIES OF MERCHANTABILITY AND FITNESS FOR A PARTICULAR PURPOSE.**

Without limiting the generality of the foregoing, Qorvo products are not warranted or authorized for use as critical components in medical, life-saving, or life-sustaining applications, or other applications where a failure would reasonably be expected to cause severe personal injury or death.

Copyright 2024 © Qorvo, Inc. | Qorvo is a registered trademark of Qorvo, Inc.

Looking for pricing, stock, or lifecycle information?

Click below to explore more details on WIN SOURCE:

-  [View QPL1240SR on WIN SOURCE](#)
-  [Qorvo US Inc. Information](#)

Optimize Your Supply Chain with WIN SOURCE Solutions

-  Global Sourcing Solution
-  Obsolete Management
-  Cost Control Management
-  Shortage Management
-  Alternative Solution
-  Excess Inventory Management