

GaAs HEMT MMIC DRIVER AMPLIFIER, 17.5 - 41.0 GHz

Typical Applications

This HMC-AUH256 is ideal for:

- Point-to-Point Radios
- Point-to-Multi-Point Radios
- VSAT
- SATCOM

Features

- Gain: 21 dB
- P1dB Output Power: +20 dBm
- Wideband Performance: 17.5 to 40 GHz
- Supply Voltage: +5V @ 295 mA
- Small Chip Size: 2.1 x 0.92 x 0.1 mm

Functional Diagram

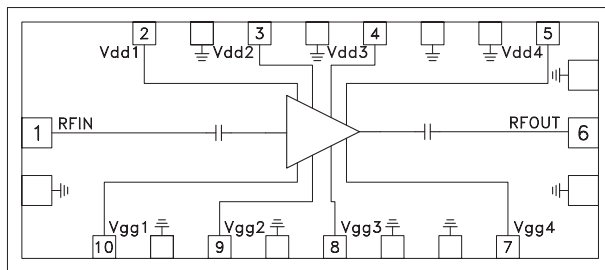

General Description

The HMC-AUH256 is a GaAs MMIC HEMT four stage Driver Amplifier which covers the frequency range of 17.5 to 40 GHz. The chip can easily be integrated into Multi-Chip-Modules (MCMs) due to its small (1.93 mm²) size. The HMC-AUH256 offers 21 dB of gain and +20 dBm output power at 1 dB compression from a bias supply of +5V @ 295 mA. The HMC-AUH256 may also be used as a frequency doubler. Detail bias condition to achieve doubler operation.

Electrical Specifications ^[1], $T_A = +25^\circ\text{C}$

$V_{dd1} = V_{dd2} = V_{dd3} = V_{dd4} = 5V$, $I_{dd1} + I_{dd2} + I_{dd3} + I_{dd4} = 295mA$ ^[2]

Parameter	Min.	Typ.	Max.	Units
Frequency Range	17.5 - 41			GHz
Gain		21		dB
Input Return Loss		8		dB
Output Return Loss		15		dB
	20 - 30 GHz	8		dB
Output Power for 1 dB Compression		20		dBm
Saturated Output Power		23		dBm
Output IP3		27		dBm
Supply Current ($I_{dd1} + I_{dd2} + I_{dd3} + I_{dd4}$)		295		mA

[1] Unless otherwise indicated, all measurements are from probed die

[2] Adjust Vgg1 = Vgg2 = Vgg3 = Vgg4 between -1V to +0.3V (Typ. -0.3V) to achieve $I_{dd1} = 50\text{ mA}$, $I_{dd2} = 50\text{ mA}$, $I_{dd3} = 75\text{ mA}$, $I_{dd4} = 120\text{ mA}$

**GaAs HEMT MMIC DRIVER
AMPLIFIER, 17.5 - 41.0 GHz**

Linear Gain vs. Frequency

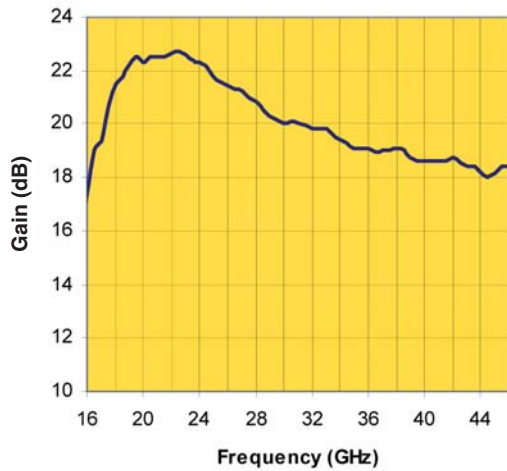

Fixtured Pout vs. Frequency

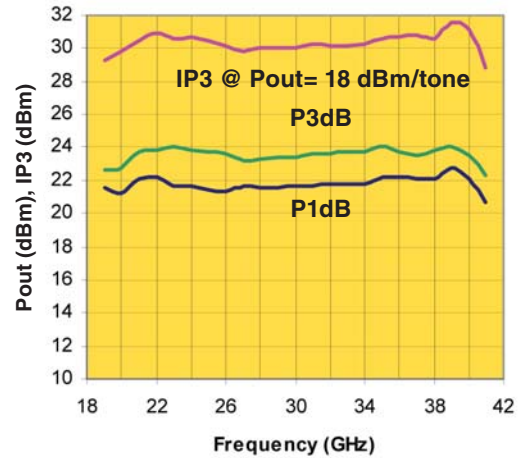

Input Return Loss vs. Frequency

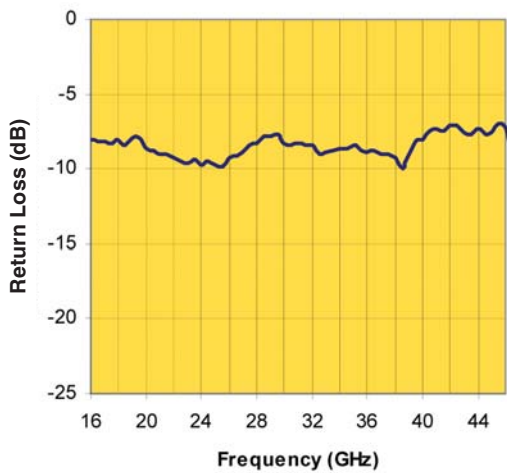

Output Return Loss vs. Frequency

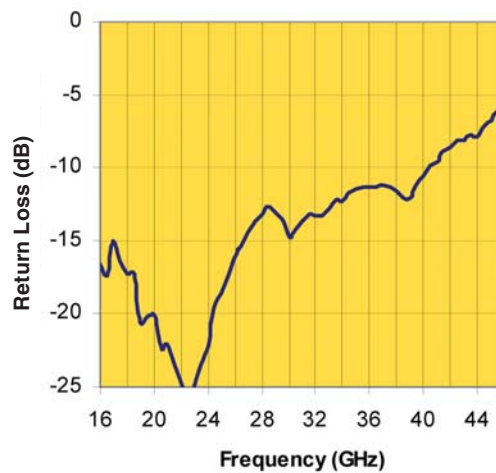

Information furnished by Analog Devices is believed to be accurate and reliable. However, no responsibility is assumed by Analog Devices for its use, nor for any infringements of patents or other rights of third parties that may result from its use. Specifications subject to change without notice. No license is granted by implication or otherwise under any patent or patent rights of Analog Devices. Trademarks and registered trademarks are the property of their respective owners.

For price, delivery, and to place orders: Analog Devices, Inc., One Technology Way, P.O. Box 9106, Norwood, MA 02062-9106 Phone: 781-329-4700 • Order online at www.analog.com Application Support: Phone: 1-800-ANALOG-D

GaAs HEMT MMIC DRIVER AMPLIFIER, 17.5 - 41.0 GHz

x2 Pout vs. Frequency (vs Pad)

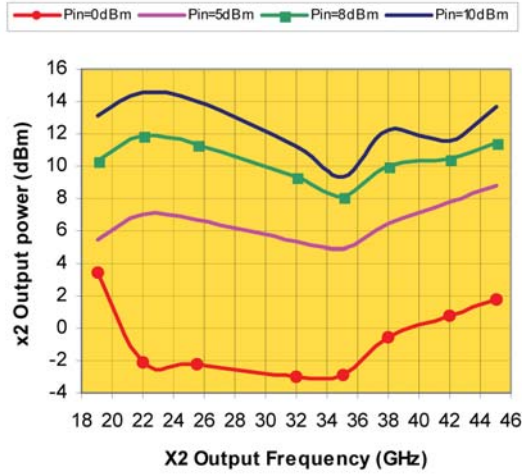

Fixture Pout vs. Frequency @ Pin= 8 dBm

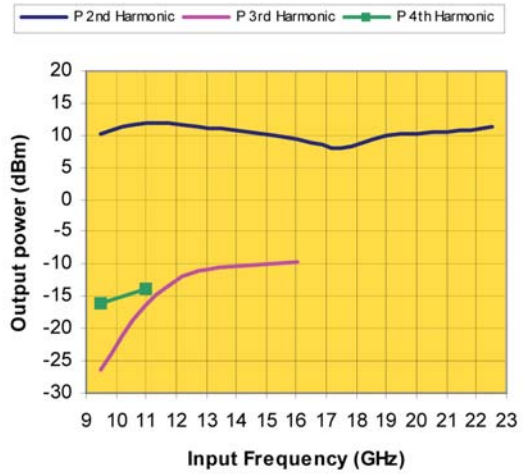

Fixture Pout vs. Frequency @ Pin= 10 dBm

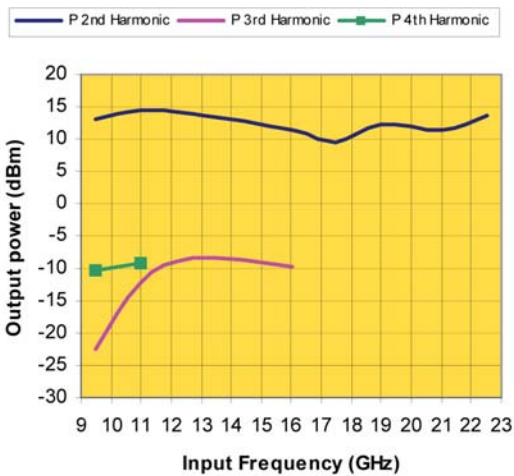

Absolute Maximum Ratings

Drain Bias Voltage	+5.5 Vdc
RF Input Power	15 dBm
Drain Bias Current (Idd1, Idd2)	62 mA
Drain Bias Current (Idd3)	93 mA
Drain Bias Current (Idd4)	150 mA
Gate Bias Voltage	-1 to +0.3 Vdc
Channel Temperature	180 °C
Thermal Resistance (channel to die bottom)	77.5 °C/W
Storage Temperature	-65 to +150 °C



**ELECTROSTATIC SENSITIVE DEVICE
OBSERVE HANDLING PRECAUTIONS**





Note: Multiplier Performance Characteristics (Typical Performance at 25°C)
Vd1= 2V, Vd2= Vd3= Vd4= 5V, Id1= 5mA, Id2+Id3+Id4= 245mA

Information furnished by Analog Devices is believed to be accurate and reliable. However, no responsibility is assumed by Analog Devices for its use, nor for any infringements of patents or other rights of third parties that may result from its use. Specifications subject to change without notice. No license is granted by implication or otherwise under any patent or patent rights of Analog Devices. Trademarks and registered trademarks are the property of their respective owners.

For price, delivery, and to place orders: Analog Devices, Inc., One Technology Way, P.O. Box 9106, Norwood, MA 02062-9106
Phone: 781-329-4700 • Order online at www.analog.com
Application Support: Phone: 1-800-ANALOG-D

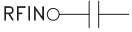
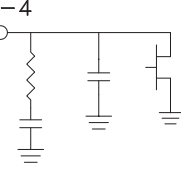
GaAs HEMT MMIC DRIVER AMPLIFIER, 17.5 - 41.0 GHz

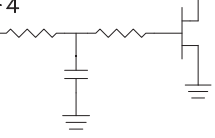
Pad Descriptions

Pad Number	Function	Pad Description	Interface Schematic
1	RFIN	This pad is AC coupled and matched to 50 Ohms.	
2 - 5	Vdd1-4	Power supply voltage for amplifier. See Assembly Diagram for required external components.	
6	RFOUT	This pad is AC coupled and matched to 50 Ohms.	
7 - 10	Vgg1-4	Gate control for amplifier. Please follow "MMIC Amplifier Biasing Procedure" application note. See assembly for required external components.	
Die Bottom	GND	Die Bottom must be connected to RF/DC ground.	

**GaAs HEMT MMIC DRIVER
AMPLIFIER, 17.5 - 41.0 GHz**

Assembly Diagram

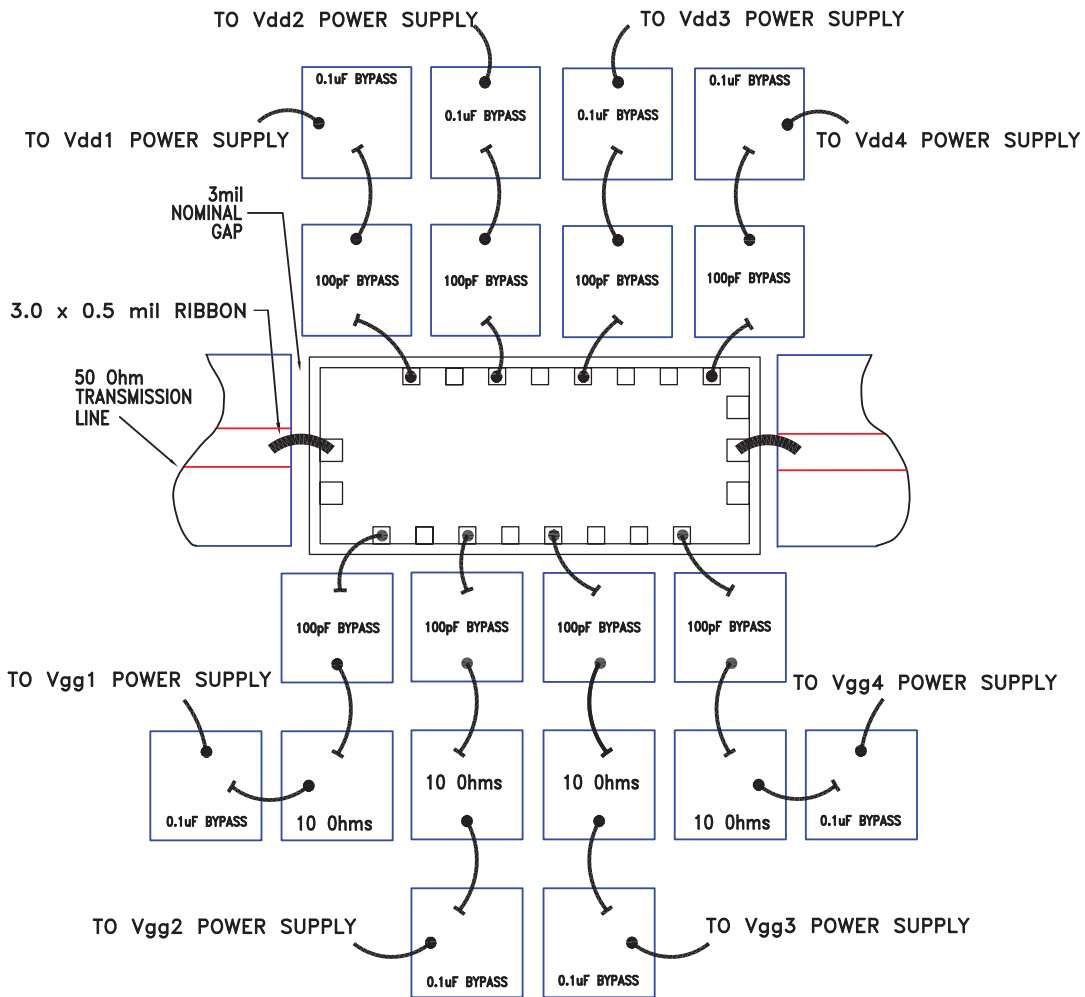

Note 1: Bypass caps should be 100 pF (approximately) ceramic (single-layer) placed no farther than 30 mils from the amplifier.

Note 2: Best performance obtained from use of <10 mil (long) by 3 by 0.5mil ribbons on input and output.

Note 3: Vdd3 can be biased using on-chip pads Vdd3 or Vdd4

Looking for pricing, stock, or lifecycle information?

Click below to explore more details on WIN SOURCE:

- ⊖ [View HMC-AUH256-SX on WIN SOURCE](#)
- ⊖ [Analog Devices Inc. Information](#)

Optimize Your Supply Chain with WIN SOURCE Solutions

- ✓ Global Sourcing Solution
- ✓ Obsolete Management
- ✓ Cost Control Management
- ✓ Shortage Management
- ✓ Alternative Solution
- ✓ Excess Inventory Management