

# POWER RELAY 1 POLE - 12A

## FTR-K1 Series

RoHS Compliant

### ■ FEATURES

- 3.5mm and 5.0mm terminal pitch
- Low profile (height: 15.7mm)
- High insulation
  - Insulation distance (between coil and contacts): 10mm min.
  - Dielectric strength: 5,000V
  - Surge strength: 10,000V
- Low coil power (400mW)
- Cadmium free contacts
- Safety standards: UL, CSA, VDE approved
- UL F class wire insulation
- Flux proof, RT II
- RoHS compliant



### ■ APPLICATIONS

Home appliances, heater control, FA equipment, I/O modules etc.

### ■ PART NUMBERS

[Example] FTR-K1 A K 012 W - MA - BG  
 (a) (b) (c) (d) (e) (f) (g)

(a)	Relay type	FTR-K1 series
(b)	Contact configuration	A : 1a (1 Form A) C : 1c (1 Form C)
(c)	Coil type / enclosure	K : Standard (400mW) / flux proof
(d)	Coil rated voltage	12 : 5...110VDC <sup>*1</sup> Please refer to coil rating table
(e)	Contact material	W : AgSnO <sub>2</sub>
(f)	Terminal pitch	MA : 3.5mm pitch MB : 5.0mm pitch
(g)	Special type	Nil : Standard type (without gold plate) BG : Gold plate 3μm

Actual marking does not carry the type name : "FTR" E.g.: Ordering code: FTR-K1AK012W-MA Actual marking: K1AK012W-MA

\*1: 110V coil is not for new design.

## ■ SPECIFICATIONS

Item		Specifications	Remarks/Conditions	
Contact	Configuration	1a (1 Form A) / 1c (1 Form C)		
Data	Construction	Single		
	Material	AgSnO <sub>2</sub>		
	Resistance	Max. 100mΩ	Initial, at 1A, 6VDC	
	Contact rating	12A, 250VAC/24VDC	Resistive	
	Max. carrying current * <sup>1</sup>	14A		
	Max. switching voltage	440VAC/300VDC		
	Max. switching power	3,000VA/288W		
	Min. switching load * <sup>2</sup>	100mA, 5VDC		
	Coil	Rated power (20°C)	400mW to 430mW	
Operate power (20°C)		196mW to 211mW		
Operating temperature range		-40 °C to +85 °C	No frost	
Time	Operate (at nominal voltage)	Max. 15ms	Without bounce	
	Release (at nominal voltage)	Max. 5ms	Without bounce, no diode	
Life	Mechanical		Min. 20 x 10 <sup>6</sup> operations	
	Electrical	AC contact rating	Min. 100 x 10 <sup>3</sup> operations	
		DC contact rating	Min. 100 x 10 <sup>3</sup> operations	
Insulation	Insulation resistance (initial)		Min. 1,000MΩ	
	Dielectric strength	Open contacts	1,000VAC (50/60Hz) 1 minute	
		Coil to contacts	5,000VAC (50/60Hz) 1 minute	
	Surge strength	Coil to contacts	10,000V / 1.2 x 50μs standard wave	
	Clearance		10mm	
	Creepage		10mm	
	EN61810-1, VDE0435	Voltage		250V
		Pollution degree		3
		Material group		IIIa
Category		C / 250V (Reference voltage) (VDE0110b)		
Others	Vibration resistance	Misoperation≥1μs	10 to 55 to 10Hz single amplitude 0.35mm	Coil ON/OFF, 3 axis, total 6 cycles
		Endurance	10 to 55 to 10Hz single amplitude 0.75mm	Coil OFF, 3 axis, total 6 hours
	Shock resistance	Misoperation≥1μs	100m/s <sup>2</sup> (11±1ms)	Coil ON/OFF, 3 axis, total 36 operations
		Endurance	1,000m/s <sup>2</sup> (6±1ms)	Coil OFF, 3 axis, total 18 operations
	Dimensions / Weight		12.7 x 29.0 x 15.7mm / Approximately 13g	
	Sealing		Flux proof, RTII	

\* 1: Need to consider the heat from PCB when max. current is more than 10A.

\* 2: Minimum switching loads mentioned above are reference values. Please perform the confirmation test with actual load before production since reference values may vary according to switching frequencies, environmental conditions and expected reliability levels.

## ■ COIL DATA

Coil Code	Rated Coil Voltage (VDC)	Coil Resistance ±10% (Ω)	Must Operate Voltage* <sup>1</sup> (VDC)	Must Release Voltage* <sup>1</sup> (VDC)	Rated Power (mW)
005	5	62	3.5	0.5	400
006	6	90	4.2	0.6	
009	9	202	6.3	0.9	
012	12	360	8.4	1.2	
018	18	810	12.6	1.8	
022	22	1,210	15.4	2.2	
024	24	1,440	16.8	2.4	
028	28	1,960	19.6	2.8	
048	48	5,360	33.6	4.8	430
060	60	8,570	42.0	6.0	420
110* <sup>2</sup>	110* <sup>2</sup>	28,800	77.0	11.0	

Note: All values in the table are valid at 20°C and zero contact current, unless otherwise specified.

\*: Specified operated values are valid for pulse wave voltage.

\*2: 110V coil is not for new design.

Note: Please use at rated coil voltage. Please refer to characteristic data and set up adequate voltage in case of use at over voltage.

## ■ SAFETY STANDARDS

Type	Compliance	Contact Rating	
		1a (1 Form A)	1c (1 Form C)
UL	Flammability: UL 94-V-0 (plastics)		
	UL508 File No. E63614	<b>[FTR-K1AK( )W-(MA, MB)]</b> 12A/16A, 24 VDC (resistive), 85°C 12/16A, 277 VAC (resistive), 85°C 1/2hp, 277VAC, 85°C 1/3hp, 125VAC, 85°C Pilot duty: B300, 85°C	<b>[FTR-K1CK( )W-(MA, MB)]</b> 12A/16A, 24 VDC (resistive), 85°C 12A/16A, 277 VAC (resistive), 85°C 1/2hp, 277VAC, 85°C 1/3hp, 125VAC, 85°C 1/8hp, 125VAC, 85°C Pilot duty: B300, 85°C
CSA	C22.2 No. 14 File No. LR40304	<b>[FTR-K1(A,C)K( )W-(MA, MB)]</b> 12A, 277VAC/24VDC (resistive) 16A, 277 VAC/24VDC (resistive) 1/2 hp, 277VAC 1/3 hp, 125VAC Pilot duty: B300	
VDE	IEC/EN61810-1 EN60335-1 clause 15.3; 16.3; 29.1; 29.2; 29.3 EN60730 clause 12.2; 13.2; 20.1; 20.2; 20.3	<b>[FTR-K1(A, C) K ( )W-(MA, MB)]</b> 12A, 250 VAC (cosφ=1), 85°C 16A, 250 VAC (cosφ=1), 85°C 12A, 24VDC (0ms), 85°C 16A, 24VDC (0ms), 85°C 3.5A, 250 VAC (cosφ=0.4), 85°C	

The part numbers on the safety standards' certifications and the ordering part numbers may differ. Coil code is in ( ).



## ■ DIMENSIONS

5.0mm pitch

Dimensions (FTR-K1AK( )W-MB)

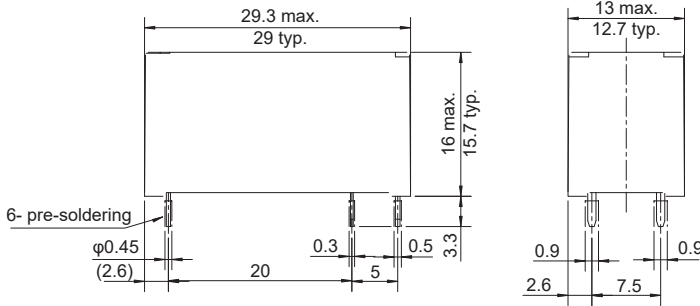

Dimensions (FTR-K1CK( )W-MB)

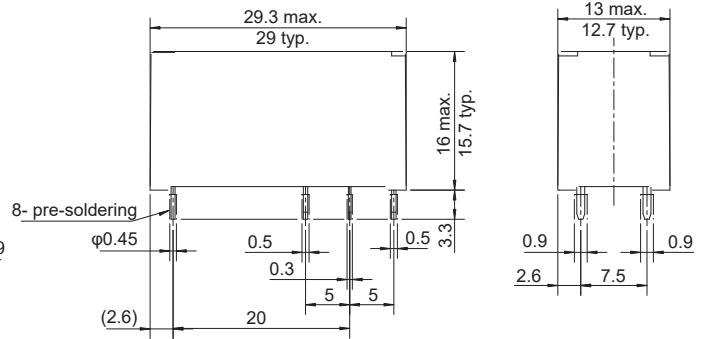

Schematics (FTR-K1AK( )W-MB)  
(BOTTOM VIEW)

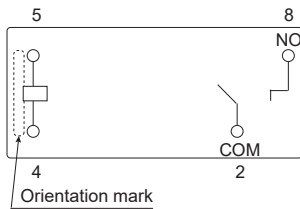

Schematics (FTR-K1CK( )W-MB)  
(BOTTOM VIEW)

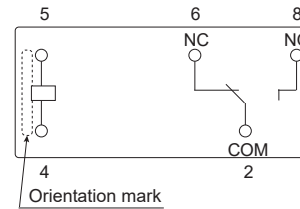

PC board mounting hole layout (FTR-K1AK( )W-MB)  
(BOTTOM VIEW)

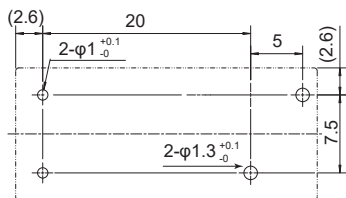

PC board mounting hole layout (FTR-K1CK( )W-MB)  
(BOTTOM VIEW)

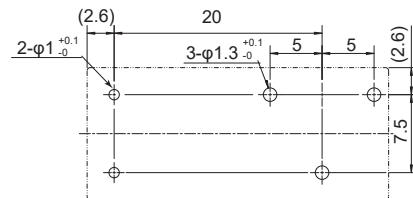

- \* Dimensions of the terminals do not include thickness of pre-soldering.
- \* Tolerance of PC board mounting hole layout :  $\pm 0.1$  unless otherwise specified.
- \* Dimensions do not include tolerances. Please ask specification in case you need tolerances.

(Unit: mm)

## CHARACTERISTIC DATA

(Characteristic data is not guaranteed value but measured values of samples from production line.)

Coil temperature rise

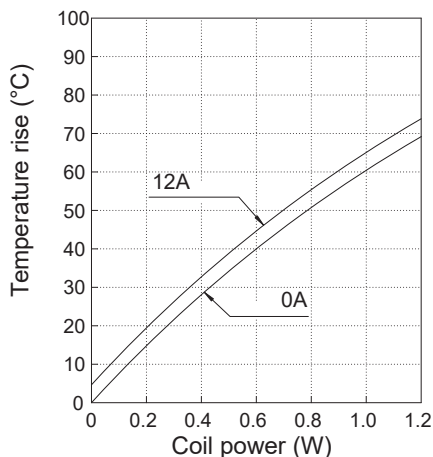

Operating range

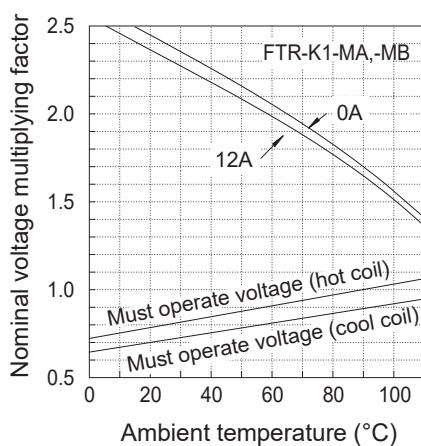

Maximum switching power

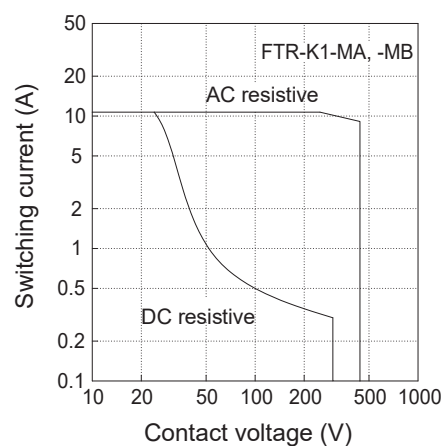

Life curve

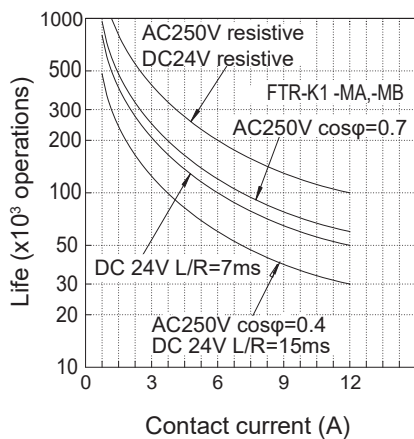

Distribution of operate, release voltage

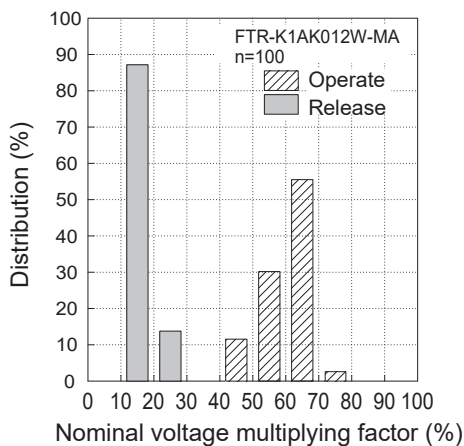

Distribution of operate, release time

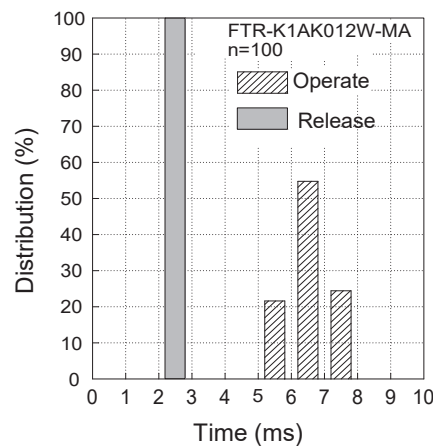

Distribution of contact resistance

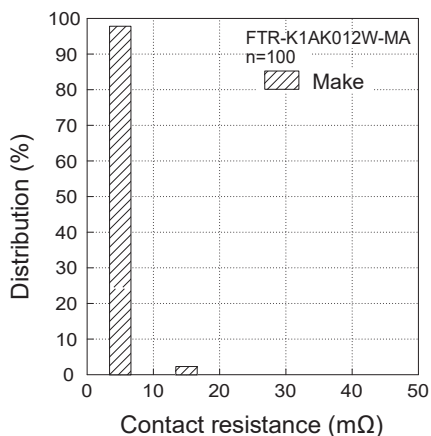

## ■ PART NUMBER LIST

Part Number	Contact Configuration	Nominal Power	Contact Material	Terminal pitch
FTR-K1AK( )W-MA	1a (1 Form A)	Standard (400 to 430mW)	AgSnO <sub>2</sub>	3.5mm
FTR-K1AK( )W-MA-BG			Gold plated AgSnO <sub>2</sub>	
FTR-K1AK( )W-MB			AgSnO <sub>2</sub>	5.0mm
FTR-K1AK( )W-MB-BG			Gold plated AgSnO <sub>2</sub>	
FTR-K1CK( )W-MA	1c (1 Form C)	Standard (400 to 430mW)	AgSnO <sub>2</sub>	3.5mm
FTR-K1CK( )W-MA-BG			Gold plated AgSnO <sub>2</sub>	
FTR-K1CK( )W-MB			AgSnO <sub>2</sub>	5.0mm
FTR-K1CK( )W-MB-BG			Gold plated AgSnO <sub>2</sub>	

## CAUTIONS

- All values mentioned in this datasheet are provided under ideal conditions. Please perform the confirmation test before actual use.
- Reflow soldering is prohibited.
- Do not use relays in the atmosphere with sulfide gas, chloride gas or nitric oxide. Contact resistance may increase.
- Do not use silicon or silicon-containing product or materials near relays. It may cause contact failure.

## GENERAL INFORMATION

### 1. ROHS Compliance

- All relays produced by FCL Components are compliant with RoHS directive 2011/65/EU, including commission delegated directive 2015/863.

### 2. Recommended lead free solder condition

- Lead free solder plating on relay terminals is Sn-3.0Ag-0.5Cu, unless otherwise specified. This material has been verified to be compatible with PbSn assembly process.
- Recommended solder for assembly: Sn-3.0Ag-0.5Cu.

#### Flow Solder Condition:

Pre-Heating: Maximum 120°C within 90 sec.

Soldering: Dip within 5 sec. at 255°C±5°C solder bath

Relay must be cooled by air immediately after soldering

#### Solder by Soldering Iron:

Soldering Iron: 30-60W

Temperature: Maximum 340-360°C

Duration: Maximum 3 sec.

**We highly recommend that you confirm your actual solder conditions**

### 3. Moisture Sensitivity

- Moisture Sensitivity Level standard is not applicable to electromechanical relays, unless otherwise indicated.

### 4. Tin Whiskers

- Dipped SnAgCu solder is known as presenting a low risk to tin whisker development. No considerable length whisker was found by our in house test.

## Contact

### Japan

FCL COMPONENTS LIMITED  
Shinagawa Seaside Park Tower  
12-4, Higashi-shinagawa 4-chome,  
Tokyo 140 0002, Japan  
Tel: +81-3-3450-1682  
Email: fcl-contact@cs.fcl-components.com

### North and South America

FCL COMPONENTS AMERICA, INC.  
2055 Gateway Place Suite 480,  
San Jose, CA 95110 USA  
Tel: +1-408-745-4900  
Email: contact@fcl-components.us

### Europe

FCL COMPONENTS EUROPE B.V.  
Diamantlaan 25  
2132 WV Hoofddorp, Netherlands  
Tel: +31-23-556-0910  
Email: info@fcl-components.eu

### Asia Pacific

FCL COMPONENTS ASIA PTE LTD.  
No. 20 Harbour Drive, #07-01B  
Singapore 117612  
Tel: +65-6375-8560  
Email: fcal@fcl-components.com

### China

FCL COMPONENTS (SHANGHAI) CO.,LTD.  
Unit 1105, Central Park - Jing An,  
No.329 Heng Feng Road, Shanghai  
200070, China  
Tel: +86-21-3253 0998  
Email: fcsh@fcl-components.com

### Hong Kong

FCL COMPONENTS HONG KONG CO.,  
LIMITED  
Unit 2313, Seapower Tower, Concordia  
Plaza, No.1 Science Museum Road,  
TST, Kowloon, Hong Kong  
Tel: +852-2881-8495  
Email: fcal@fcl-components.com

Web: [www.fcl-components.com/en/](http://www.fcl-components.com/en/)

---

© 2025 FCL Components Limited. All rights reserved. All trademarks or registered trademarks are the property of their respective owners.

FCL Components Products are intended for general use, including without limitation, in personal, household and office environments, in buildings and for ordinary use in the industry. FCL Components Products are not intended to be used in applications where extremely high safety is required ("High Safety Required Applications"), such as, but not limited to, applications in nuclear facilities, in aircraft automatic flight control, in air traffic control, in mass transit system control, in missile launch system, in weapon systems, in medical equipment for life support or any application involving a direct serious risk of physical injury or death.

Please do not use FCL Components Products without securing the sufficient safety and reliability required for the High Safety Required Applications.

In addition, FCL Components shall not be liable against the customer and/or any third party for any claims or damages arising in connection with the use of FCL Components Products in the High Safety Required Applications.

FCL Components warrants that its Products, if properly used and services, will conform to their specification and will be free from defects in material and workmanship for twelve months from delivery.

The implied warranties of merchantability and fitness for a particular purpose and all other warranties, representations and conditions, express or implied by statute, trade usage or otherwise, except as set forth in this warranty, are excluded and shall not apply to the Products delivered.

The contents, data and information in this datasheet are provided by FCL Components Limited as a service only to its user and only for general information purposes. The use of the contents, data and information provided in this datasheet is at the users' own risk.

FCL Components has assembled this datasheet with care and will endeavor to keep the contents, data and information correct, accurate, comprehensive, complete and up to date.

FCL Components Limited and affiliated companies do however not accept any responsibility or liability on their behalf, nor on behalf of its employees, for any loss or damage, direct, indirect or consequential, with respect to this datasheet, its contents, data, and information and related graphics and the correctness, reliability, accuracy, comprehensiveness, usefulness, availability and completeness thereof. Nor do FCL Components Limited and affiliated companies accept on their behalf, nor on behalf of its employees, any responsibility or liability with respect to these datasheets, its contents, data, information and related graphics and the correctness, reliability, accuracy, comprehensiveness, usefulness, availability and completeness thereof. Rev. January 20, 2025 (S25).

## Looking for pricing, stock, or lifecycle information?

Click below to explore more details on WIN SOURCE:

-  [View FTR-K1CK012W-MA on WIN SOURCE](#)
-  [FCL Components Information](#)

## Optimize Your Supply Chain with WIN SOURCE Solutions

-  Global Sourcing Solution
-  Obsolete Management
-  Cost Control Management
-  Shortage Management
-  Alternative Solution
-  Excess Inventory Management