

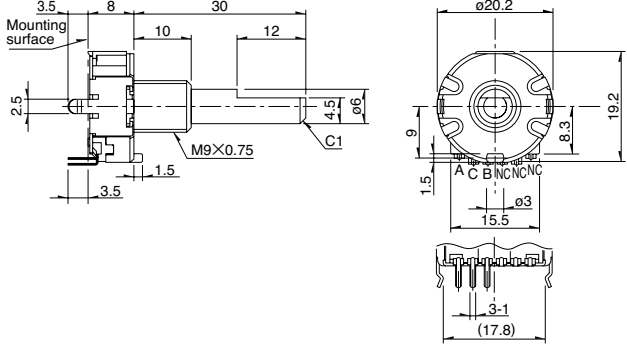
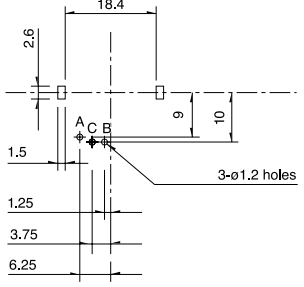

Dimensions

Unit:mm

No.	Photo	Style	PC board mounting hole dimensions (View from mounting side)
2			
3			

Output Wave (EC20A)

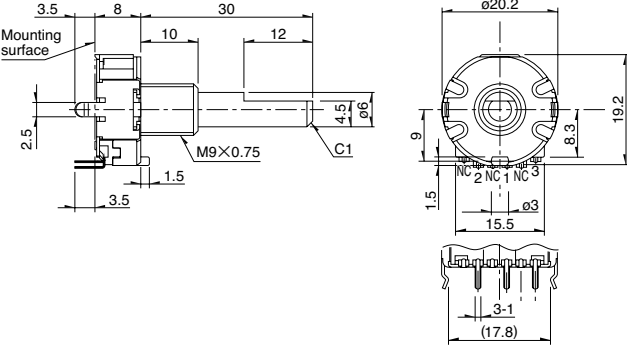
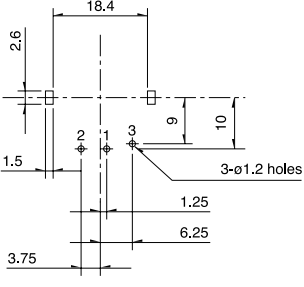
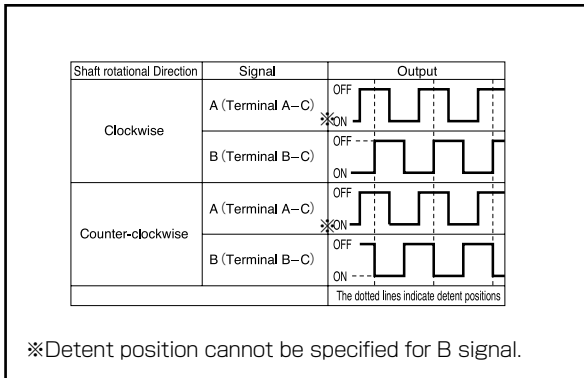

Output Wave (EC20A)

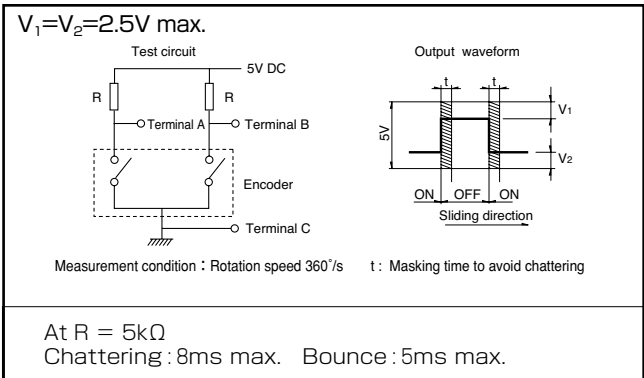

■ Circuit Diagram (RK203)

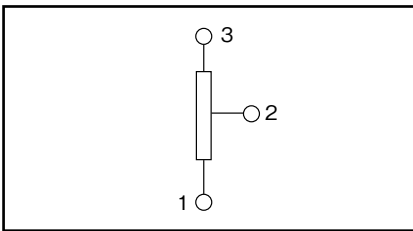

20mm Size Metal Shaft Type / Attached Parts









The following parts are included with the product

		Unit:mm
Nut		Washer

20mm Size Metal Shaft Encoder Type / Switch Specifications

The attachment switch is applied only for the encoder type.

Switch type		Momentary push switch
Contact arrangement		Single pole and single throw (Push-on)
Travel (mm)		1.5±0.5
Operating force		4±2N
Operating life		20,000 times
Electrical performance	Rating	0.1A 5V DC (0.1mA 5V DC min. ratings)
	Contact resistance	100mΩ max. for initial period, 200mΩ max. after operating life.
	Insulation resistance	10MΩ min. 50V DC
	Voltage proof	50V AC for 1 minute or 60V AC for 2 second

Type		Metal shaft	Insulated shaft		
		20mm size	12mm size		18mm size
Series		EC20A	EC12E	EC12D	EC18A
Photo					
Output		Incremental (Two phase A and B)			Absolute type
Shaft types		Single-shaft			
Operating direction		Vertical			
Number of pulse / Number of detent		18/18	12/12 24/24 24/without	15/30	12 positions 15 positions 16 positions
Features		—	—	With push-on switch	Water resisting performance (IPX7)
Dimensions (mm)	W	20.2	12.4	12.5	18.8
	D	19.2	13.2	11.7	18
	H	10	5		8.75
Operating temperature range		-30°C to +80°C	-10°C to +70°C	-40°C to +85°C	-20°C to +60°C
Operating life		30,000 cycles	15,000 cycles 30,000 cycles	30,000 cycles	
Automotive use		●	—	●	—
Life cycle (availability)					
Electrical performance	Rating	1mA 5V DC	0.5mA 5V DC	1mA 5V DC	1mA 10V DC
	Max./min. operating current (Resistive load)	—	5mA / 0.5mA	10mA / 1mA	—
	Insulation resistance	10MΩ min. 50V DC		100MΩ min. 250V DC	10MΩ min. 250V DC
	Voltage proof	50V AC for 1 minute or 60V AC for 2s	50V AC for 1 minute	300V AC for 1 minute or 360V AC for 1s	50V AC for 1 minute or 60V AC for 2s
Mechanical performance	Rotational torque (Without detent)	—	10mN·m max. 25±15mN·m 40±15mN·m	—	—
	Detent torque	40±20mN·m	3±2mN·m 3 to 20mN·m	5±3mN·m 10±5mN·m	60±20mN·m
	Push-pull strength	100N	80N	100N	Push 100N / Pull 50N
Shaft configuration		Flat	Flat, Through shaft	Flat	
Terminal type		Insertion			
Switch Specifications	Switch type	Push-on switch	—	Push-on switch	—
	Contact arrangement	Single pole and single throw (Push-on)	—	Single pole and single throw (Push-on)	—
	Travel (mm)	1.5±0.5	—	0.5±0.3	—
	Operating force (N)	4±2	—	3 ^{+1.5} ₋₁ 6 ^{+2.5} ₋₂	—
	Rating	0.1A 5V DC (0.1mA 5V DC min. ratings)	—	1mA 5V DC (10mA 5V DC max. ratings)	—
	Contact resistance	100mΩ max. for initial period; 200mΩ max. after operating life.	—	100mΩ max. for initial period; 200mΩ max. after operating life.	—
	Operating life	20,000 times	—	30,000 times	—
Page		273	276		280

Encoders Soldering Conditions	299
Encoders Cautions	300

Note

● Indicates applicability to all products in the series.

Reference for Manual Soldering

Series	Tip temperature	Soldering time	No. of solders
EC05E, EC09E, EC10E, EC111, EC11B, EC11E, EC11G, EC11K, EC11M, EC11N, EC12D, EC12E, EC18A, EC21A, EC28A, EC35A, EC35AH, EC40A, EC45A, EC50A, EC60B, EM11B, EC21C, EC28C, EC35CH	350°C max.	3s max.	1 time
EC11J	350±10°C	3 ⁺¹ ₀ s	2 times

Reference for Dip Soldering

Series	Preheating		Dip soldering		No. of solders
	Soldering surface temperature	Heating time	Soldering temperature	Soldering time	
EC09E, EC11B, EC111, EC11E, EC11G, EC11K, EC11M, EC11N, EC18A, EC21A, EC28A, EC35A, EC35AH, EC50A, EC60B	100°C max.	2 min. max.	260±5°C	5±1s	2 times max.
EM11B	100°C max.	1 min. max.	260°C max.	3s max.	2 times max.
EC10E, EC12D, EC12E	100°C max.	1 min. max.	260±5°C	3±1s	2 times max.
EC40A	110°C max.	1 min. max.	260°C max.	10s max.	1 time
EC45A	100°C max.	2 min. max.	260°C max.	5s max.	2 times max.

Example of Reflow Soldering Condition

Temperature profile

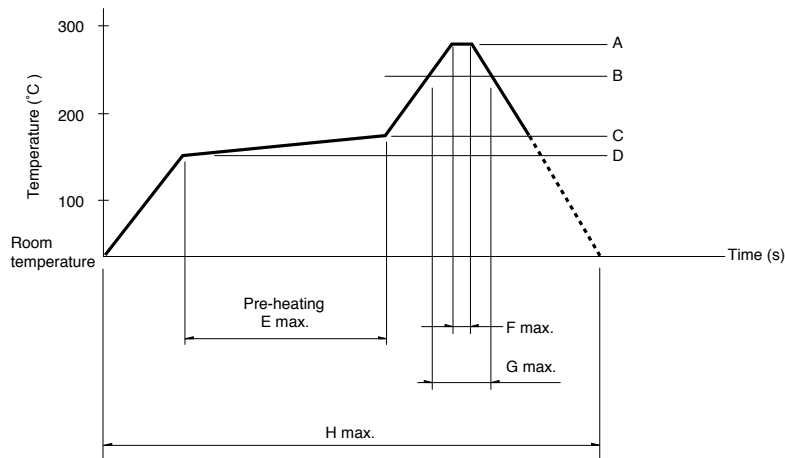



Series	A	B	C	D	E	F	G	H	No. of reflows
EC11J	260°C	230°C	180°C	150°C	2 min. max.	3s	40s	4 min. max.	2 times max.
EC05E	250°C min.	230°C min.	180°C	150°C	60s to 120s	—	30s to 40s	—	2 times max.
EC21C	230°C to 245°C	220°C	200°C	150°C	60s to 120s	—	25s to 60s	300s max.	1 time max.
EC28C, EC35CH	260°C	230°C	180°C	150°C	2 min. min.	3s	40s	230s max.	1 time max.

Notes

- When using an infrared reflow oven, solder may sometimes not be applied. Be sure to use a hot air reflow oven or a type that uses infrared rays in combination with hot air.
- The temperatures given above are the maximum temperatures at the terminals of the encoder when employing a hot air reflow method. The temperature of the PC board and the surface temperature of the encoder may vary greatly depending on the PC board material, its size and thickness. Ensure that the surface temperature of the encoder does not rise to 250°C or greater.
- Conditions vary to some extent depending on the type of reflow bath used. Be sure to give due consideration to this prior to use.

Looking for pricing, stock, or lifecycle information?

Click below to explore more details on WIN SOURCE:

-  [View EC20A1824401 on WIN SOURCE](#)
-  [Alps Alpine Information](#)

Optimize Your Supply Chain with WIN SOURCE Solutions

-  Global Sourcing Solution
-  Obsolete Management
-  Cost Control Management
-  Shortage Management
-  Alternative Solution
-  Excess Inventory Management