



MEDIUM POWER, HIGH GAIN

Wideband Amplifier

ZVA-02303HP+ ZVA-02303HPX+

50Ω 2* to 30 GHz

THE BIG DEAL

- High Gain of 38 dB typ.
- Excellent Gain flatness, ±1 dB typ.
- Saturated Output Power, +28 dBm typ.
- Available with and without heatsink
- Operates with a single DC supply of +12 to +15 V
- Over-Voltage and Reverse Voltage protected

APPLICATIONS

- Wideband Test and Instrumentation
- 5G
- SATCOM
- EW



Generic photo used for illustration purposes only

Model No.	ZVA-02303HP+	ZVA-02303HPX+▲
Case Style	T2704	
Connectors	2.92mm Female	

+RoHS Compliant
The +Suffix identifies RoHS Compliance. See our web site for RoHS Compliance methodologies and qualifications

PRODUCT OVERVIEW

Mini-Circuits' ZVA-02303HP+ is a coaxial, medium power, wideband and high gain amplifier operating from 2 GHz to 30 GHz. The model operates over a single positive supply range of +12 to +15 V, allowing users to choose their desired operating voltage. Internal DC-DC conversion circuitry maintains constant efficiency over the full input voltage range. The amplifier incorporates several DC-protection features such as over-voltage, reverse voltage and In-rush current that protects the amplifier from damage if mishandled during operation. The amplifier is capable of delivering over +28 dBm of saturated RF power over the entire band and has excellent Noise Figure performance of 3.8 dB typ. The wideband operation combined with high output power makes it an ideal choice for testing and instrumentation applications.

KEY FEATURES

Feature	Advantages
Wide-band amplifier, 2* to 30 GHz	A single amplifier serves the need for applications including Test & Instrumentation, 5G bands, SATCOM, etc.
<ul style="list-style-type: none"> • High Gain • Wideband • High RF Power 	The amplifier is capable of providing high gain of 38 dB typ. over the entire operating band with a high output RF power of over +28 dBm typ. at saturation.
Adjustable DC supply voltage	The device is capable of operating from +12 to +15 V with constant DC power consumption with no effect on RF performance.
DC Protection <ul style="list-style-type: none"> • Over-voltage • Reverse voltage • In-rush current 	The internal DC circuitry allows the amplifier to be protected from external mishandling that could lead to catastrophic failures in the field.

*Usable down to 500 MHz

REV. OR
ECO-008098
ZVA-02303HP+
AD/JM/CP/PS
210616





MEDIUM POWER, HIGH GAIN

Wideband Amplifier

ZVA-02303HP+
ZVA-02303HPX+

ELECTRICAL SPECIFICATIONS AT 25°C

Parameter	Condition (GHz)	ZVA-02303HP+ ZVA-02303HPX+▲			Units
		Min.	Typ.	Max.	
Frequency Range		0.5		30	GHz
Gain	0.5 - 2	34	38		dB
	2 - 30	35	38		
Gain Flatness	2 - 30		±1		dB
Output Power at 1dB compression	0.5 - 2	24	27		dBm
	2 - 10	25	28.5		
	10 - 20	24	27.5		
	20 - 30	24	26.5		
Saturated Output Power ¹	0.5 - 2	27	29		dBm
	2 - 10	27	30.5		
	10 - 20	27	29		
	20 - 30	27	28.5		
Noise Figure	0.5 - 30		3.8	6.5	dB
Output IP3 (output power = 15 dBm/tone)	0.5 - 10		38		dBm
	10 - 20		35		
	20 - 30		32		
Input VSWR	0.5 - 2.0		1.4		:1
	2 - 30		1.7		
Output VSWR	0.5 - 2		1.3		:1
	2.0 - 30		1.4		
Operating DC Voltage ² , VDD		12		15	V
Device Operating Current ³	At 12V		500	720	mA
	At 15V		400	600	mA
DC Operating Power at Operating DC Voltage			6	8.5	W

1. With Input Power up to 0 dBm.

2. DC Supply must be able to source at least 800 mA at startup.

3. Maximum Operating Current is specified at Saturated Output Power.

▲ For unit without heatsink, the baseplate temperature must be limited to 70°C at max. ambient temperature. Suitable heat-sinking mechanism must be provided to ensure the baseplate does not exceed this temperature.

MAXIMUM RATINGS⁵

Parameter	Ratings
Operating Temperature (Ambient)	-40°C to +50°C
Storage Temperature	-55°C to +100°C
Total Power Dissipation	9.0 watts
RF Input Power ⁴ (CW)	+2 dBm
DC Voltage	+16V

4. Specified under matched load to 50 ohms.

5. Continuous operation is not recommended at these extremes. Permanent damage may occur if any of these limits are exceeded.





MEDIUM POWER, HIGH GAIN

Wideband Amplifier

ZVA-02303HP+ ZVA-02303HPX+

OUTLINE DRAWING

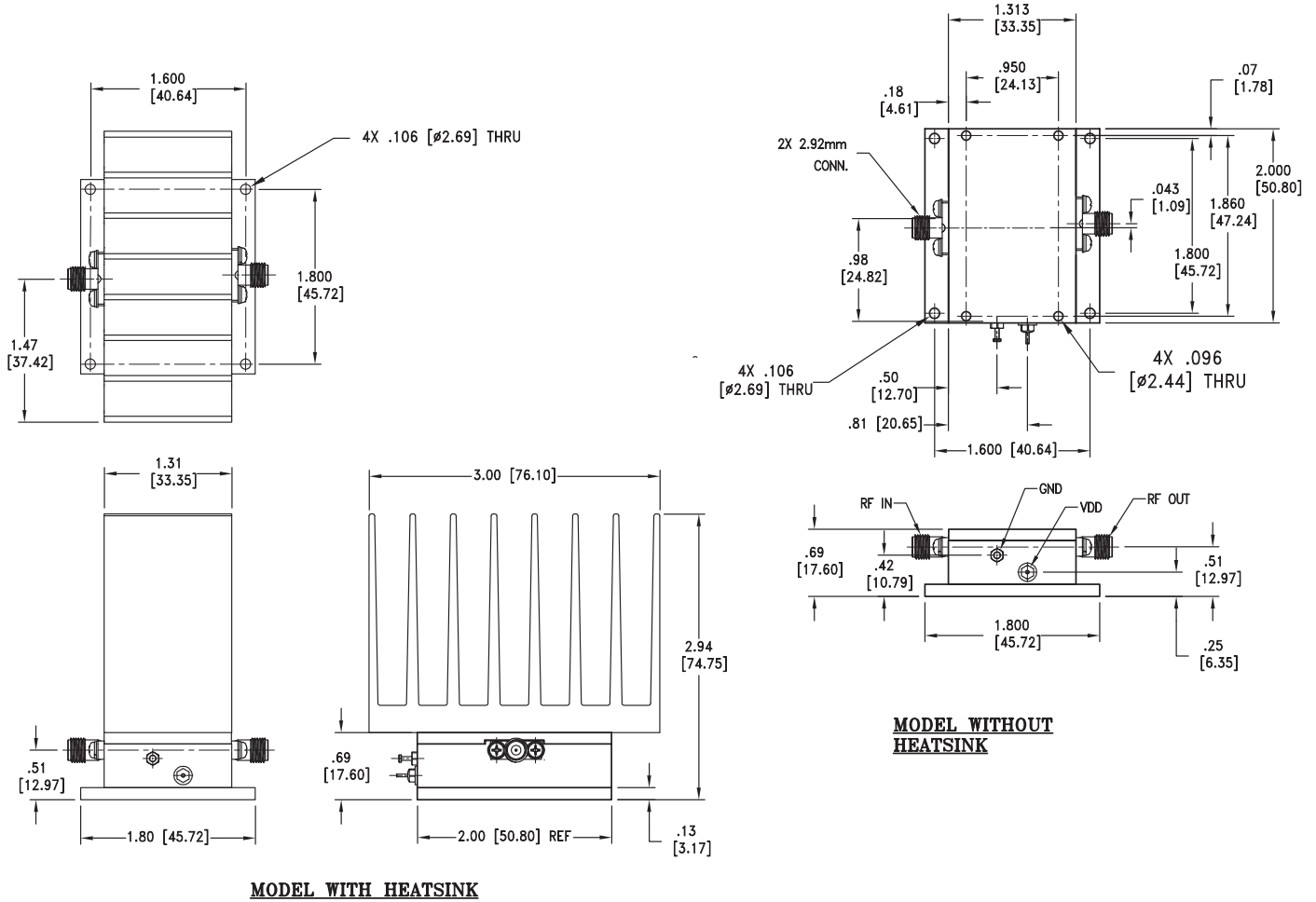

Weight: 350 grams; Weight without heatsink: 220 grams

Dimensions are in inches (mm). Tolerances: 2 Pl.±.03; 3 Pl. ± .015



MEDIUM POWER, HIGH GAIN

Wideband Amplifier

ZVA-02303HP+ ZVA-02303HPX+

TYPICAL PERFORMANCE DATA/CURVES

Frequency (MHz)	Gain (dB)	Directivity (dB)	VSWR (:1)		NOISE FIGURE (dB)	POUT at 1 dB COMPR. (dBm)	POUT at SATURATION (dBm)	OIP3 (dBm)
			IN	OUT				
500	36.01	72.71	1.77	1.47	5.28	26.19	28.67	37.54
1000	38.19	67.94	1.64	1.21	4.55	27.48	29.79	39.44
2000	38.93	65.89	1.50	1.08	4.33	28.70	30.72	40.90
4000	39.49	77.34	1.24	1.03	3.86	28.95	30.69	41.19
6000	39.28	67.07	1.02	1.18	3.58	29.33	30.75	40.53
8000	38.46	76.13	1.12	1.25	3.35	29.41	30.58	40.06
10000	38.08	71.70	1.39	1.15	3.21	28.39	29.99	38.55
12000	38.13	73.68	1.52	1.05	2.96	28.41	29.77	37.60
15000	38.11	81.89	1.15	1.05	3.07	27.94	29.14	36.03
18000	37.77	74.09	1.20	1.10	3.44	27.18	29.20	34.99
20000	37.54	67.03	1.38	1.12	3.59	25.97	28.78	33.88
23000	38.26	73.29	1.30	1.04	3.59	27.06	28.76	33.58
26000	38.17	65.54	1.05	1.34	3.87	27.04	28.38	33.21
30000	36.91	69.29	1.37	1.03	4.37	26.18	28.05	32.49

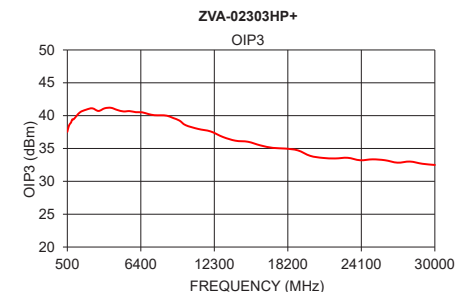
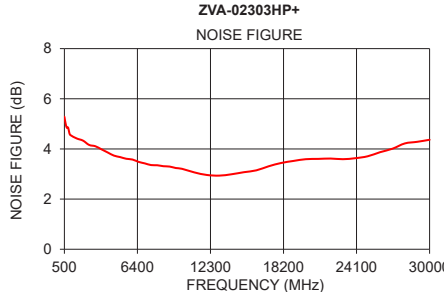
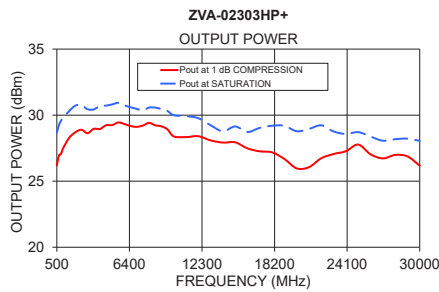
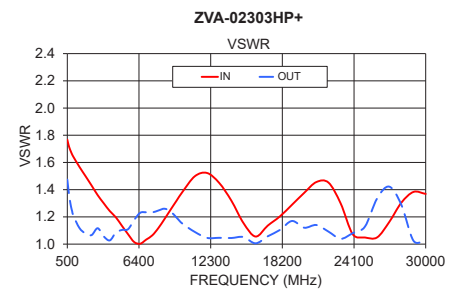
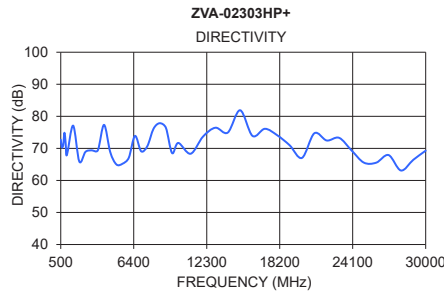
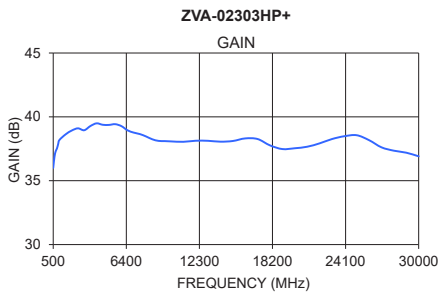

- NOTES**
- A. Performance and quality attributes and conditions not expressly stated in this specification document are intended to be excluded and do not form a part of this specification document.
 - B. Electrical specifications and performance data contained in this specification document are based on Mini-Circuits' applicable established test performance criteria and measurement instructions.
 - C. The parts covered by this specification document are subject to Mini-Circuits standard limited warranty and terms and conditions (collectively, "Standard Terms"); Purchasers of this part are entitled to the rights and benefits contained therein. For a full statement of the standard. Terms and the exclusive rights and remedies thereunder, please visit Mini-Circuits' website at www.minicircuits.com/MCLStore/terms.jsp



Looking for pricing, stock, or lifecycle information?

Click below to explore more details on WIN SOURCE:

 [View ZVA-02303HP+ on WIN SOURCE](#)

 [Mini-Circuits Information](#)

Optimize Your Supply Chain with WIN SOURCE Solutions

-  Global Sourcing Solution
-  Obsolete Management
-  Cost Control Management
-  Shortage Management
-  Alternative Solution
-  Excess Inventory Management