

GaAs PHEMT MMIC 1 WATT POWER AMPLIFIER, DC - 22 GHz

Typical Applications

The HMC797A is ideal for:

- Test Instrumentation
- Military & Space
- Fiber Optics

Features

- High P1dB Output Power: +29 dBm
- High Psat Output Power: +31 dBm
- High Gain: 15 dB
- High Output IP3: 41 dBm
- Supply Voltage: +10 V @ 400 mA
- 50 Ohm Matched Input/Output
- Die Size: 2.89 x 1.55 x 0.1 mm

Functional Diagram

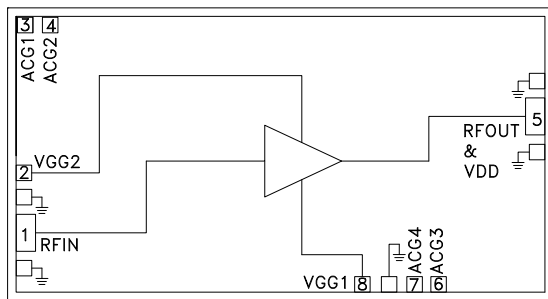

General Description

The HMC797A is a GaAs MMIC pHEMT Distributed Power Amplifier which operates between DC and 22 GHz. The amplifier provides 15 dB of gain, +29 dBm of output power at 1 dB gain compression, +31 dBm of saturated output power, and 23% PAE while requiring 400 mA from a +10 V supply. With up to +41 dBm of output IP3, the HMC797A is ideal for high linearity applications in military and space as well as test equipment where high order modulations are used. This versatile PA exhibits a positive gain slope from 2 to 20 GHz making it ideal for EW, ECM, Radar and test equipment applications. The HMC797A amplifier I/Os are internally matched to 50 Ohms facilitating integration into Multi-Chip-Modules (MCMs). All data is taken with the chip connected via two 0.025 mm (1 mil) wire bonds of minimal length 0.31 mm (12 mils).

Electrical Specifications, $T_A = +25^\circ\text{C}$, $V_{dd} = +10\text{V}$, $V_{gg2} = +3.5\text{V}$, $I_{dd} = 400\text{ mA}^*$

Parameter	Min.	Typ.	Max.	Min.	Typ.	Max.	Min.	Typ.	Max.	Units
Frequency Range	DC - 10			10 - 18			18 - 22			GHz
Gain	13	14.5		13.5	15		14	16		dB
Gain Flatness		±0.5			±0.7			±0.4		dB
Gain Variation Over Temperature		0.007			0.008			0.010		dB/°C
Input Return Loss		15			16			17		dB
Output Return Loss		17			17			15		dB
Output Power for 1 dB Compression (P1dB)	27	29		27	29		26.5	29		dBm
Saturated Output Power (Psat)		31			31			31.5		dBm
Output Third Order Intercept (IP3) *Measurement taken at Pout/Tone = + 18 dBm		42			41			40		dBm
Noise Figure		3.5			3			3.5		dB
Supply Current (Idd)		400			400			400		mA
Supply Voltage (Vdd)	8	10	11	8	10	11	8	10	11	V

*Adjust Vgg1 between -2 to 0 V to achieve Idd = 400 mA typical, Vgg1 = -0.6V Typical to achieve Idd = 400 mA.

**GaAs PHEMT MMIC
1 WATT POWER AMPLIFIER, DC - 22 GHz**

Broadband Gain & Return Loss

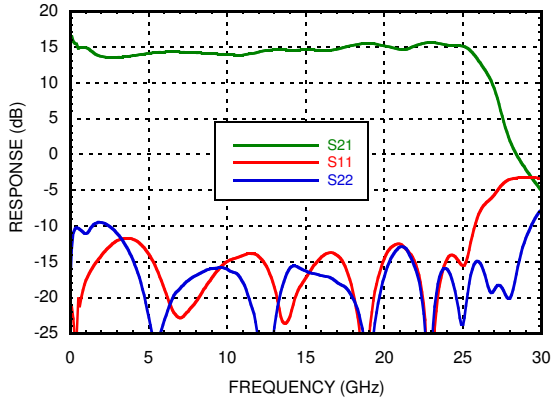

Low Frequency Gain & Return Loss

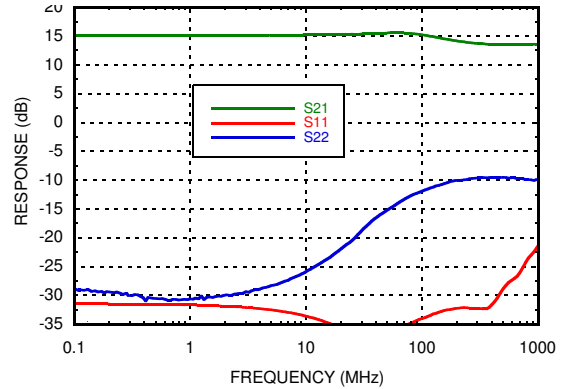

Gain vs. Temperature

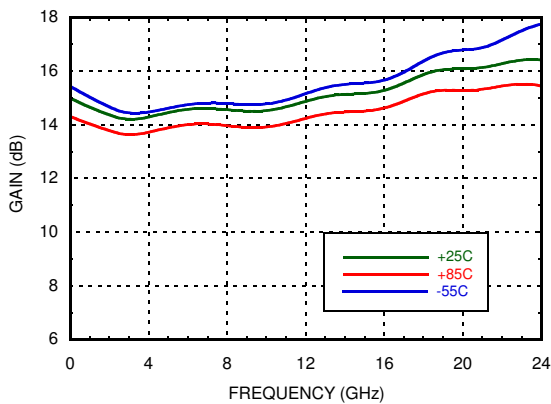

Gain vs. Vdd

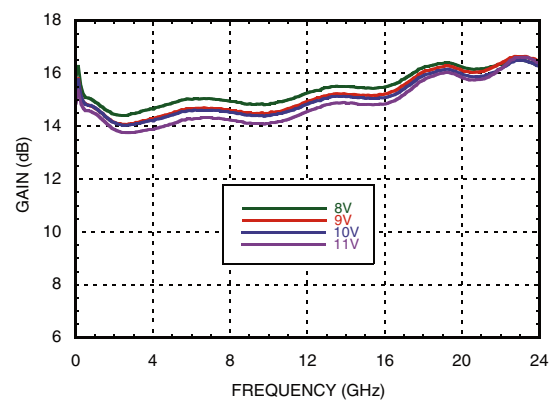

Gain vs. Idd

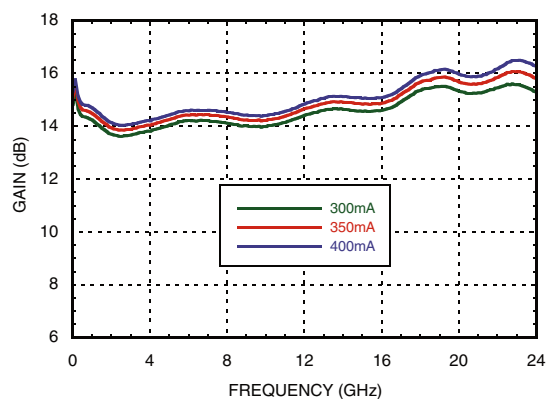

Input Return Loss vs. Temperature

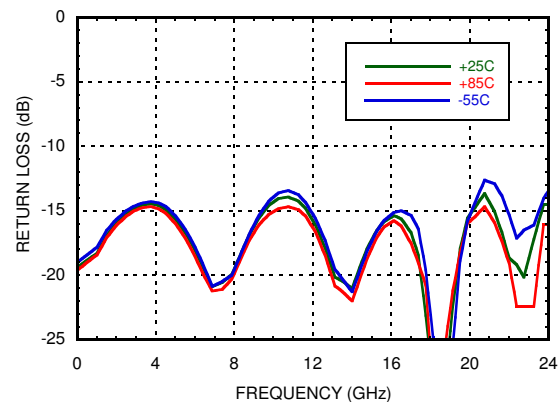

**GaAs PHEMT MMIC
1 WATT POWER AMPLIFIER, DC - 22 GHz**

Input Return Loss vs. Vdd

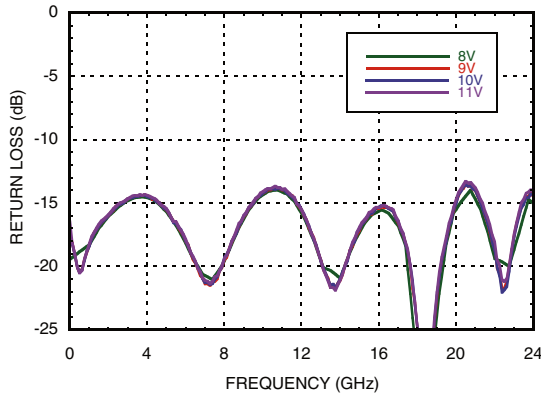

Input Return Loss vs. Idd

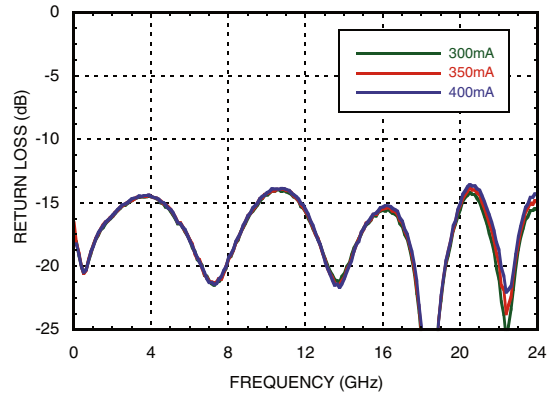

Output Return Loss vs. Temperature

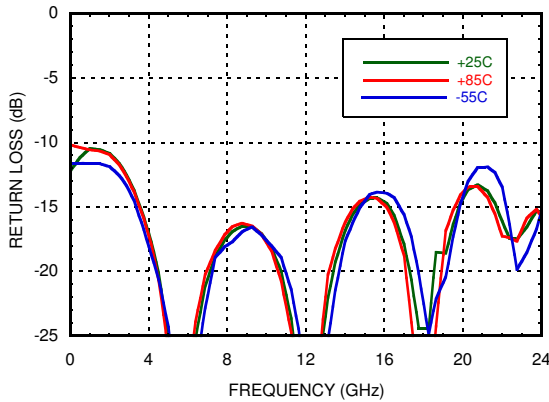

Output Return Loss vs. Vdd

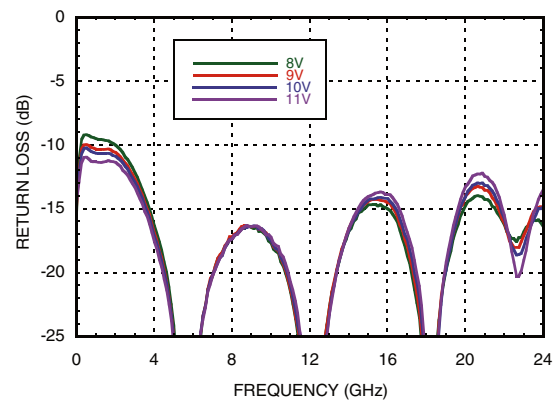

Output Return Loss vs. Idd

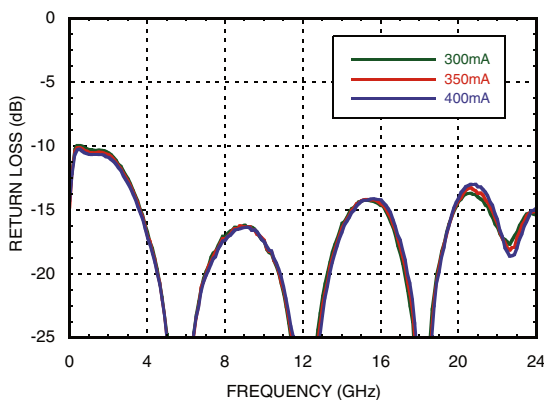

Reverse Isolation vs. Temperature

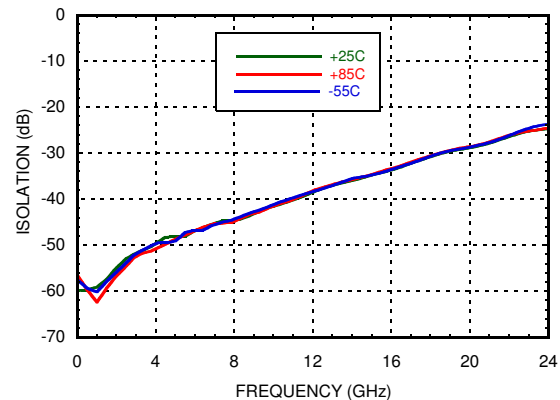

**GaAs PHEMT MMIC
1 WATT POWER AMPLIFIER, DC - 22 GHz**

Noise Figure vs. Temperature

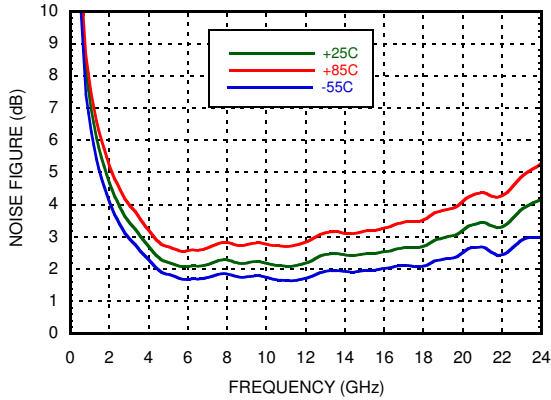

Noise Figure vs. Idd

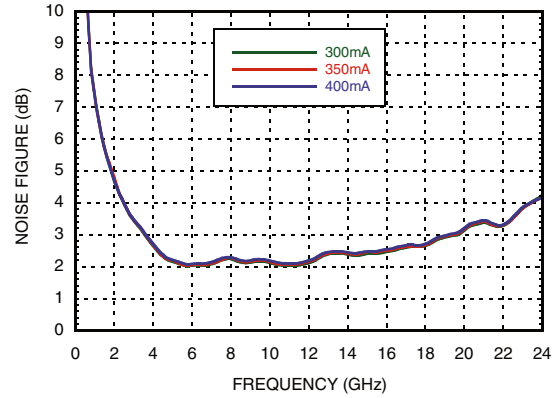

Low Frequency P1dB vs. Temperature

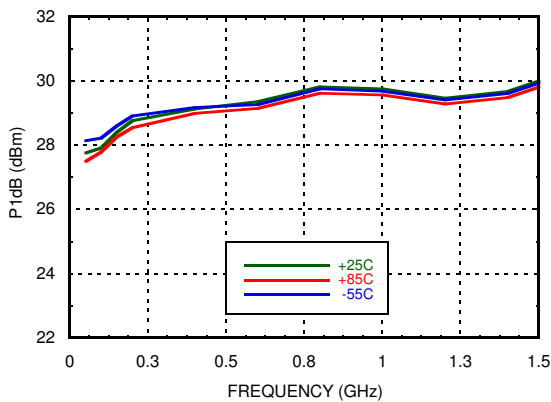

P1dB vs. Temperature

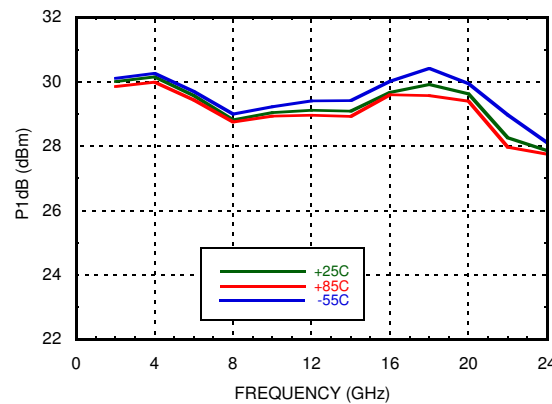

P1dB vs. Vdd

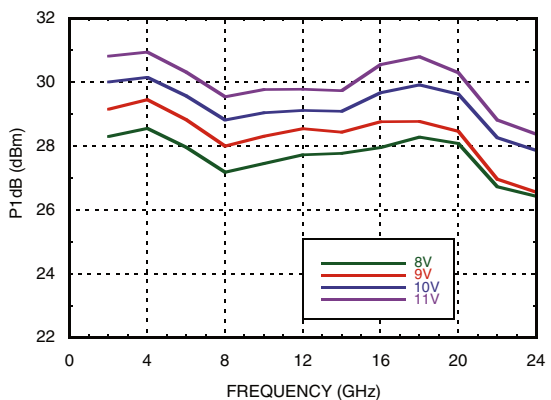

P1dB vs. Idd

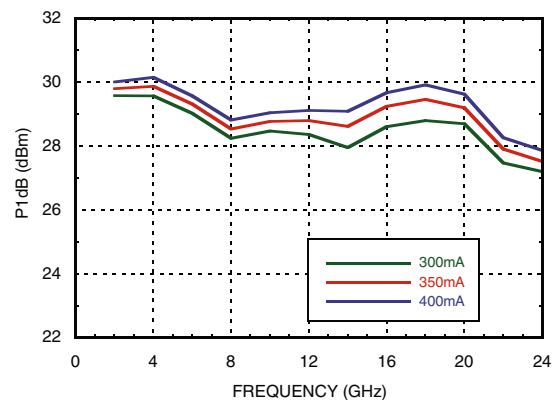

**GaAs PHEMT MMIC
1 WATT POWER AMPLIFIER, DC - 22 GHz**

Low Frequency Psat vs. Temperature

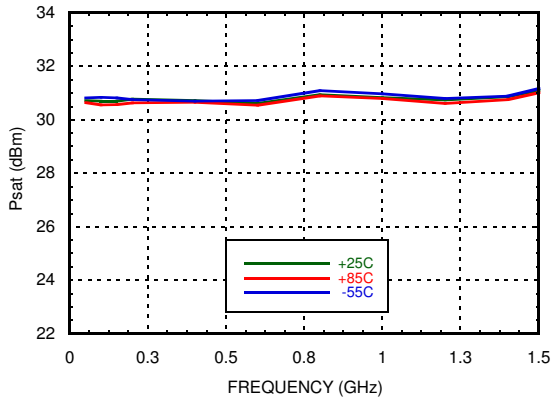

Psat vs. Temperature

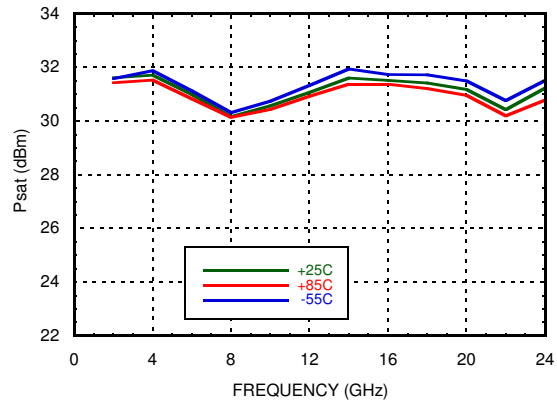

Psat vs. Vdd

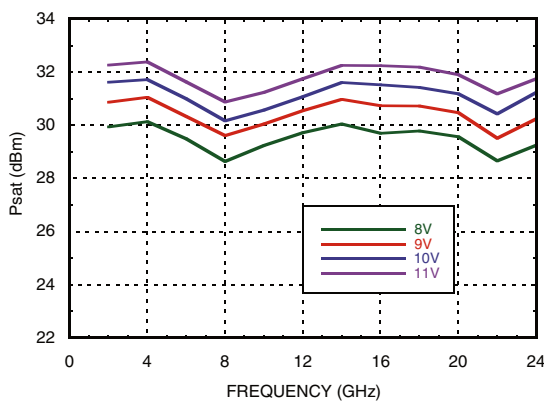

Psat vs. Idd

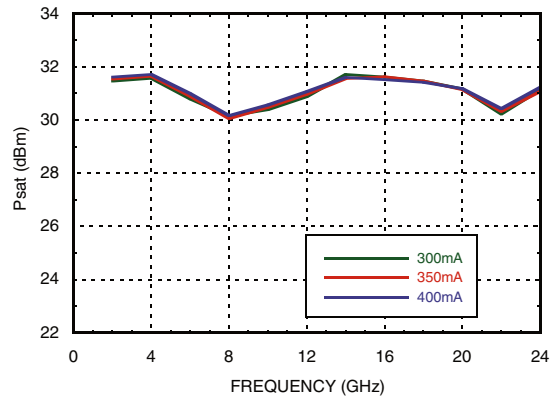

Power Compression @ 2 GHz

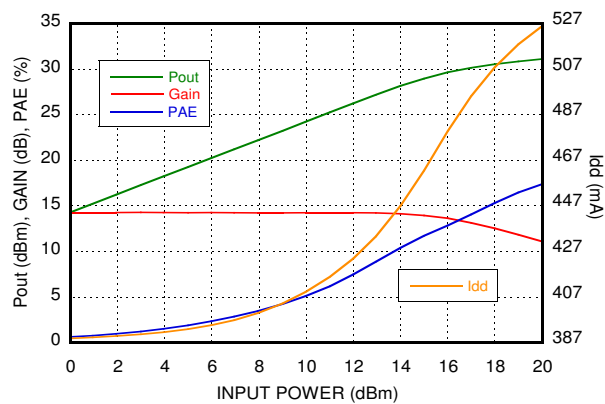

Power Compression @ 10 GHz

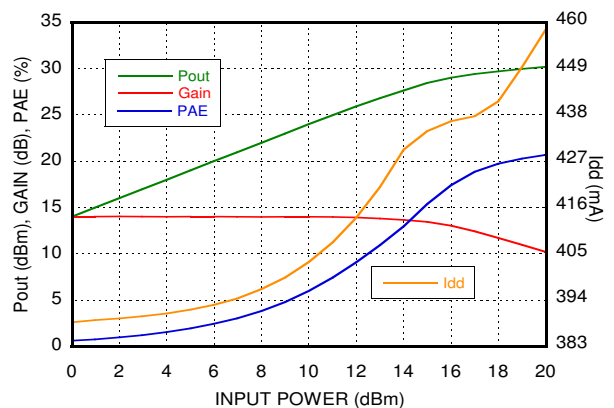

GaAs PHEMT MMIC 1 WATT POWER AMPLIFIER, DC - 22 GHz

Power Compression @ 22 GHz

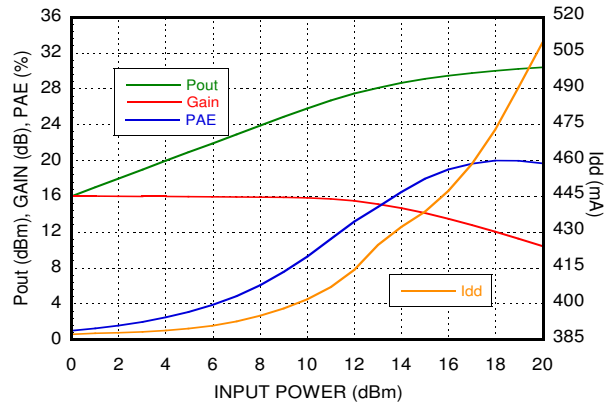

PAE @ Psat vs. Frequency

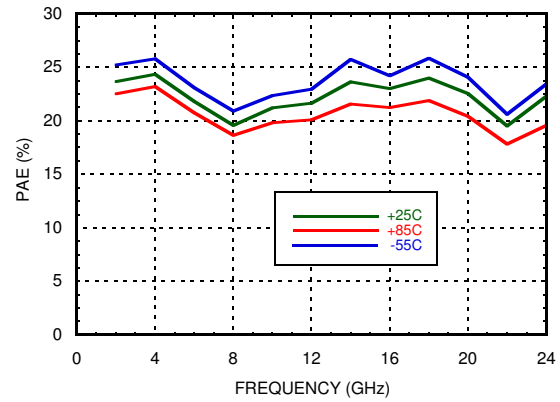

Power Dissipation @ 85 C

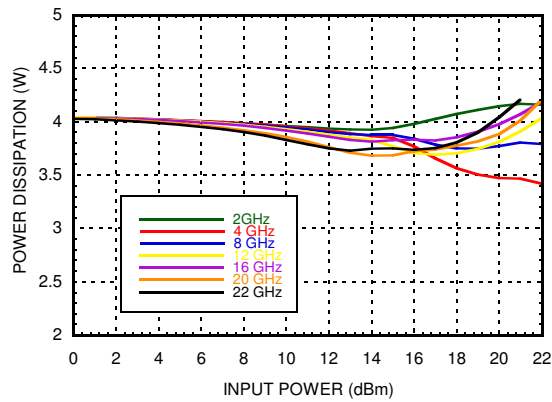

Gain & Power vs. Vdd @ 2 GHz

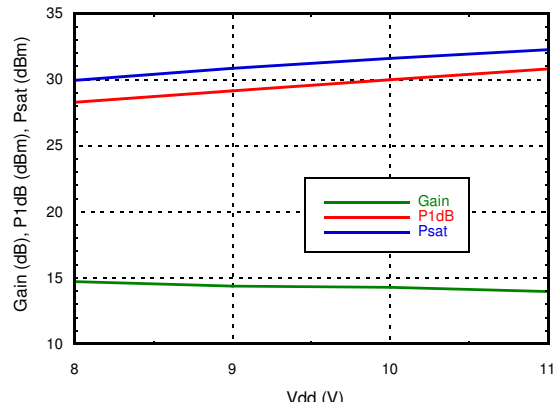

Gain & Power vs. Vdd @ 10 GHz

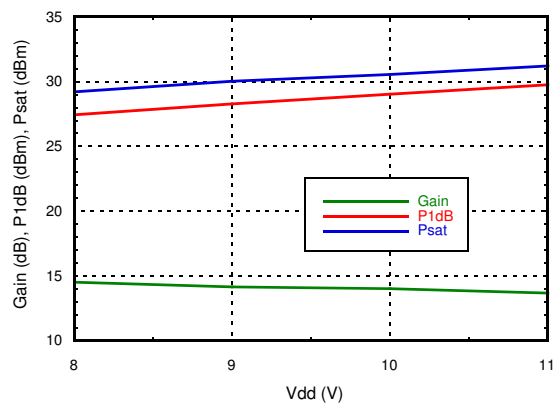

Gain & Power vs. Vdd @ 22 GHz

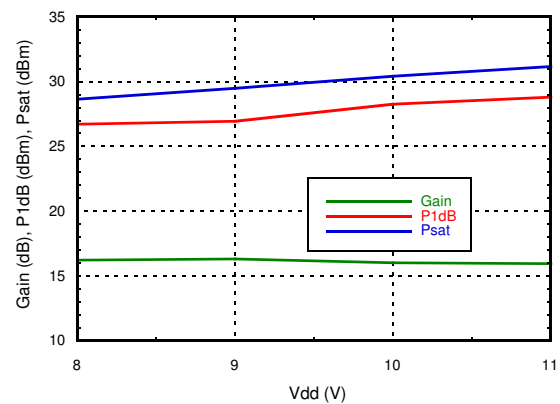

**GaAs PHEMT MMIC
1 WATT POWER AMPLIFIER, DC - 22 GHz**

Gain & Power vs. I_{dd} @ 2 GHz

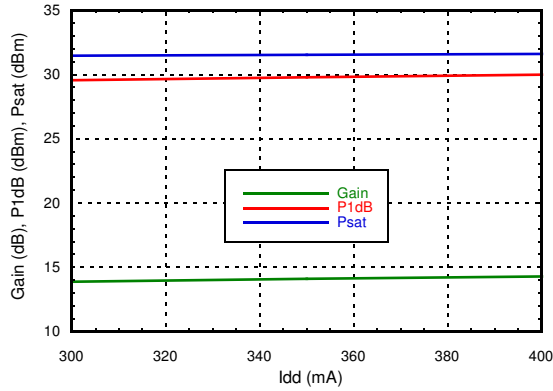

Gain & Power vs. I_{dd} @ 10 GHz

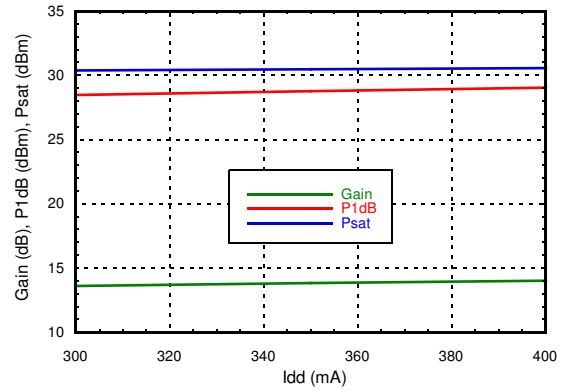

Gain & Power vs. I_{dd} @ 22 GHz

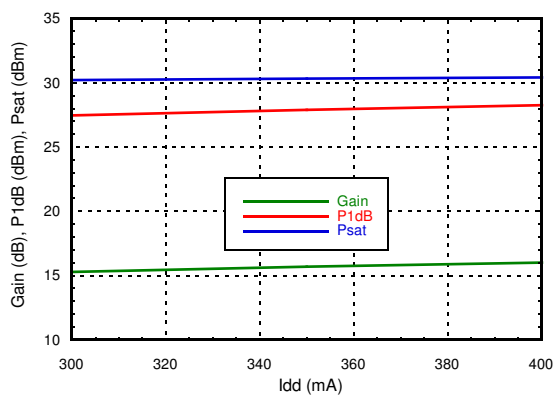

**Output IP₃ vs. Temperature
@ P_{out} = +18 dBm / Tone**

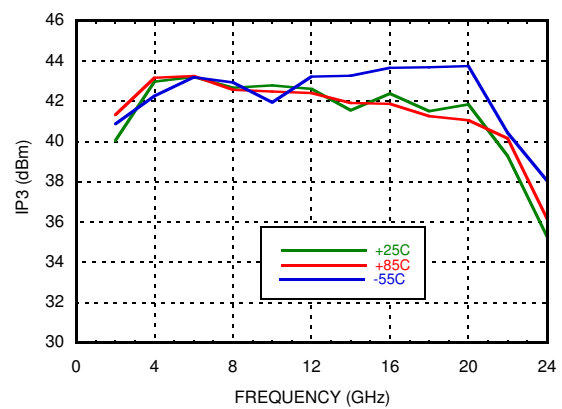

**Output IP₃ vs. V_{dd}
@ P_{out} = 18 dBm / Tone**

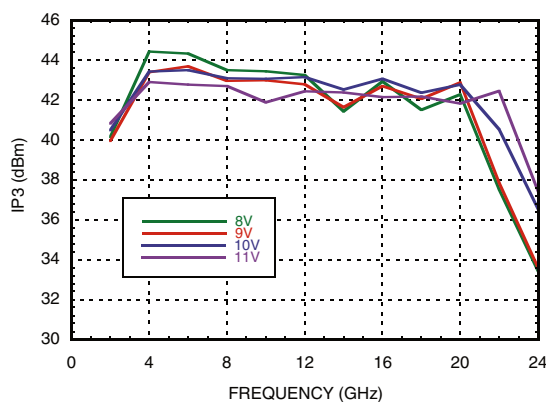

**Output IP₃ vs. I_{dd}
@ P_{out} = 18 dBm / Tone**

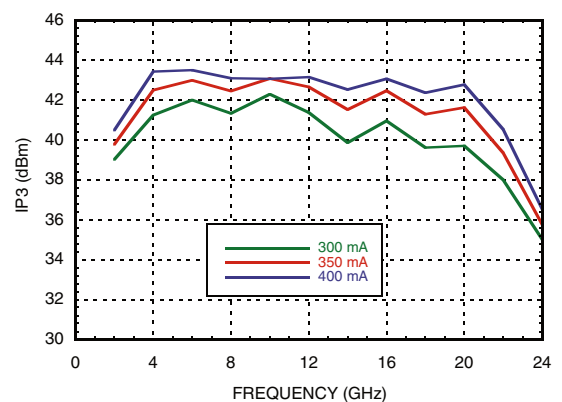

**GaAs PHEMT MMIC
1 WATT POWER AMPLIFIER, DC - 22 GHz**

Output IM3 @ Vdd = 8 V

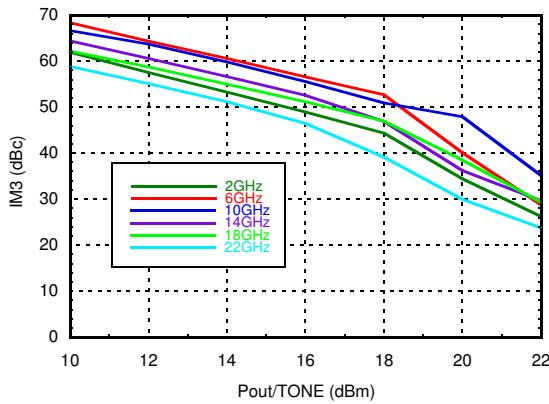

Output IM3 @ Vdd = 9 V

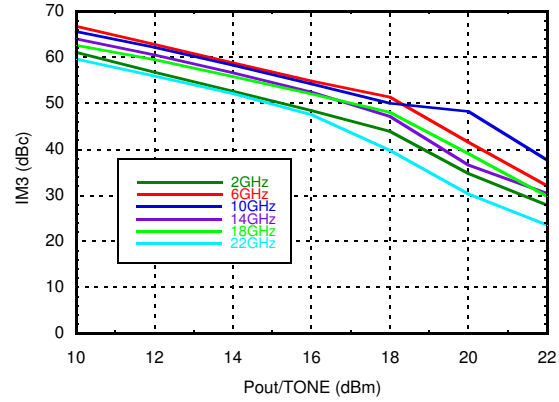

Output IM3 @ Vdd = 10 V

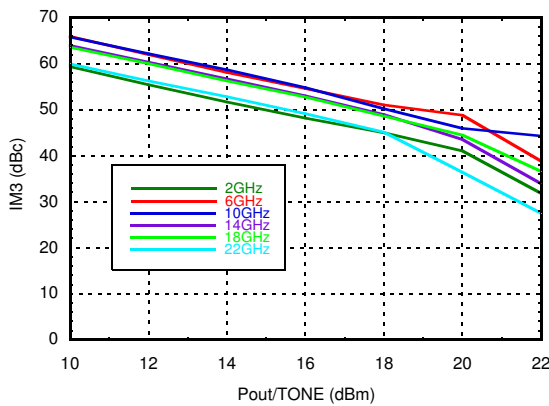

Output IM3 @ Vdd = 11 V

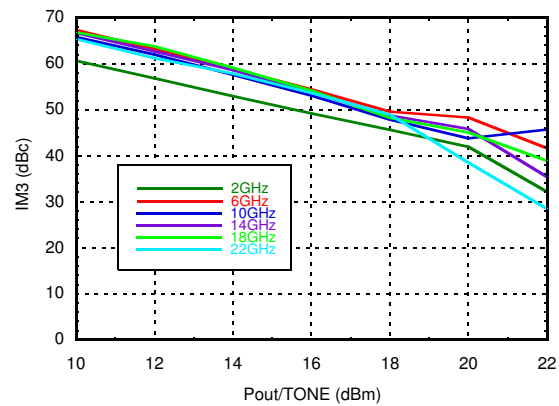

**OIP2 vs. Temperature
@ Pout = +18 dBm / Tone**

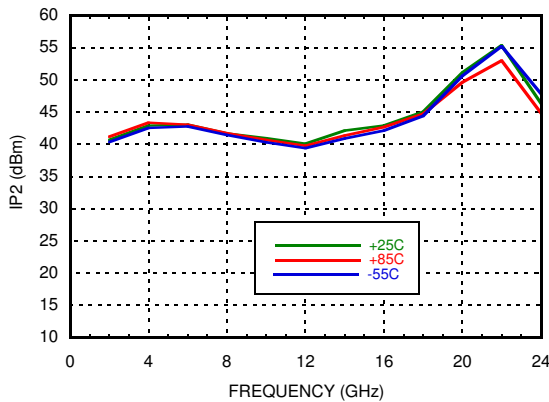

**OIP2 vs. Vdd
@ Pout = +18 dBm / Tone**

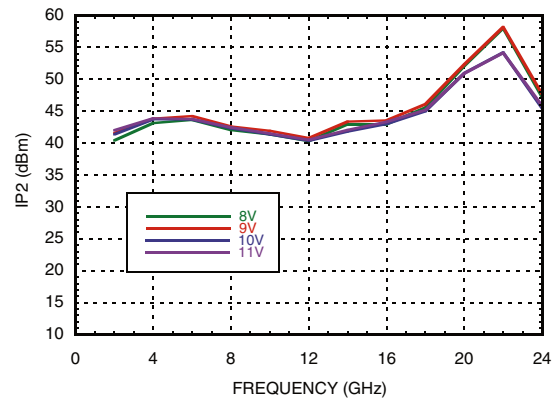

**GaAs PHEMT MMIC
1 WATT POWER AMPLIFIER, DC - 22 GHz**

OIP2 vs. Idd
@ Pout = +18 dBm / Tone

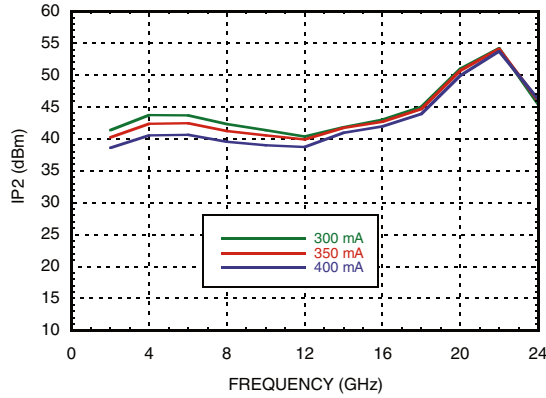

Second Harmonics vs. Temperature
@ Pout = + 18dBm

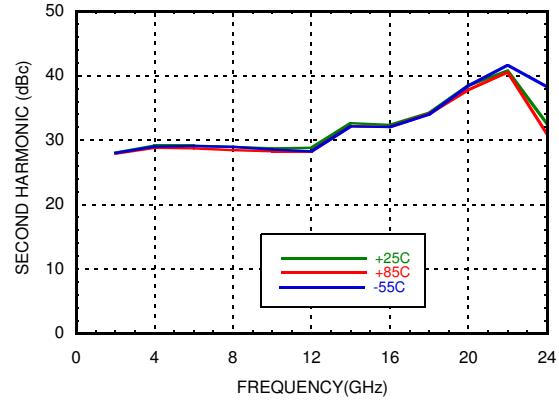

Second Harmonics vs. Vdd
@ Pout = + 18dBm

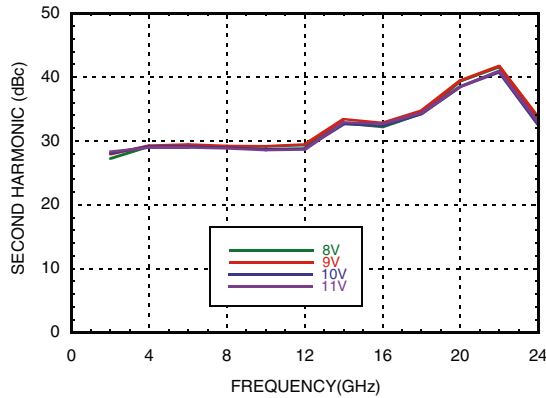

Second Harmonics vs. Idd
@ Pout = + 18dBm

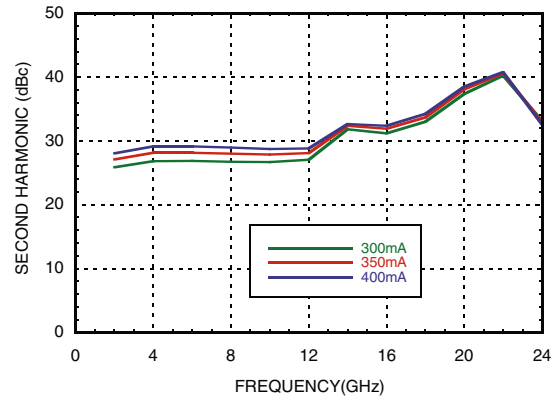

Second Harmonics vs. Pout

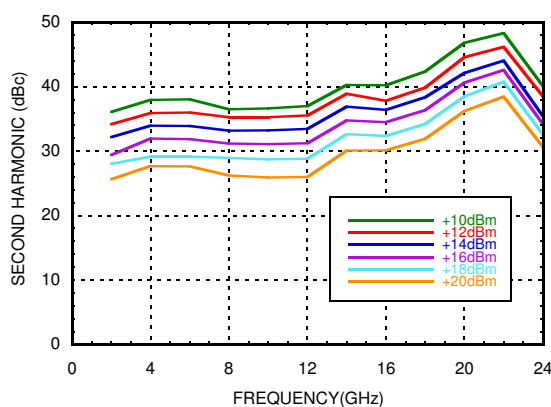

Igg1 vs. RF Input Power

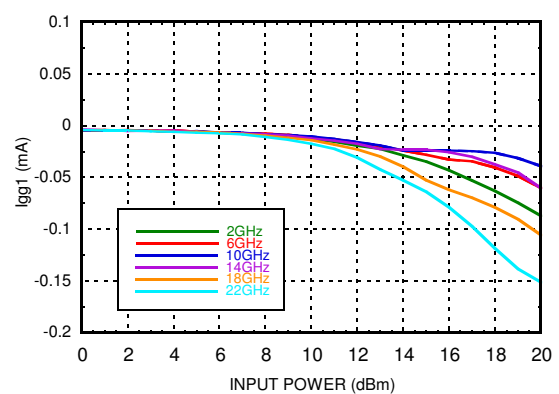

**GaAs PHEMT MMIC
1 WATT POWER AMPLIFIER, DC - 22 GHz**

I_{gg2} vs. RF Input Power

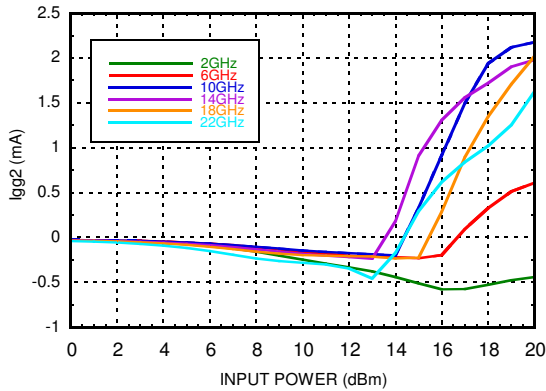

**I_{dd} vs. V_{gg1}
Representative of a Typical Device**

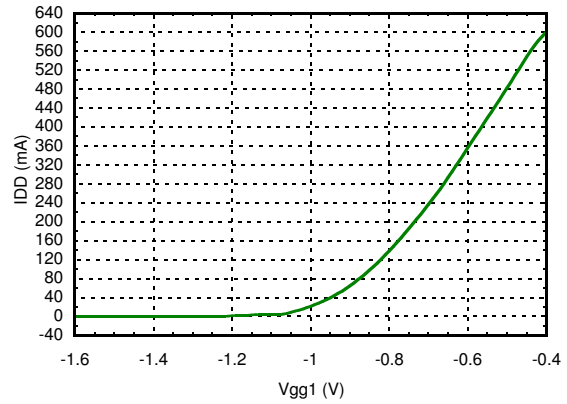

**Additive Phase Noise Vs Offset Frequency,
RF Frequency = 8 GHz**

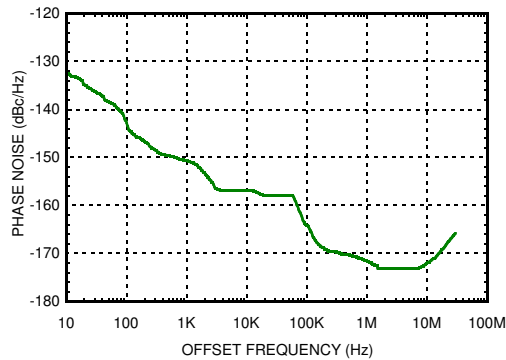

GaAs PHEMT MMIC 1 WATT POWER AMPLIFIER, DC - 22 GHz

Absolute Maximum Ratings

Drain Bias Voltage (Vdd)	+12 Vdc
Gate Bias Voltage (Vgg1)	-3 to 0 Vdc
Gate Bias Voltage (Vgg2)	+2.5 V to (Vdd - 6.5 V)
Continuous Pdiss (T= 85 °C) (derate 63.7 mW/°C above 85 °C)	5.73 W
RF Input Power (RFIN)	+27 dBm
Output Load VSWR	7:1
Storage Temperature	-65 to 150 °C
Operating Temperature	-55 to +85 °C
ESD Sensitivity (HBM)	Class 1A - Passed 250V

Reliability Information

Channel Temperature	175 °C
Nominal Junction Temperature (T=85 °C, Vdd = 10 V)	147.8 °C
Thermal Resistance (channel to die bottom)	15.7 °C/W

Stresses at or above those listed under Absolute Maximum Ratings may cause permanent damage to the product. This is a stress rating only, functional operation of the product at these or any other conditions above those indicated in the operational section of this specification is not implied. Operation beyond the maximum operating conditions for extended periods may affect product reliability.



**ELECTROSTATIC SENSITIVE DEVICE
OBSERVE HANDLING PRECAUTIONS**

GaAs PHEMT MMIC 1 WATT POWER AMPLIFIER, DC - 22 GHz

Outline Drawing

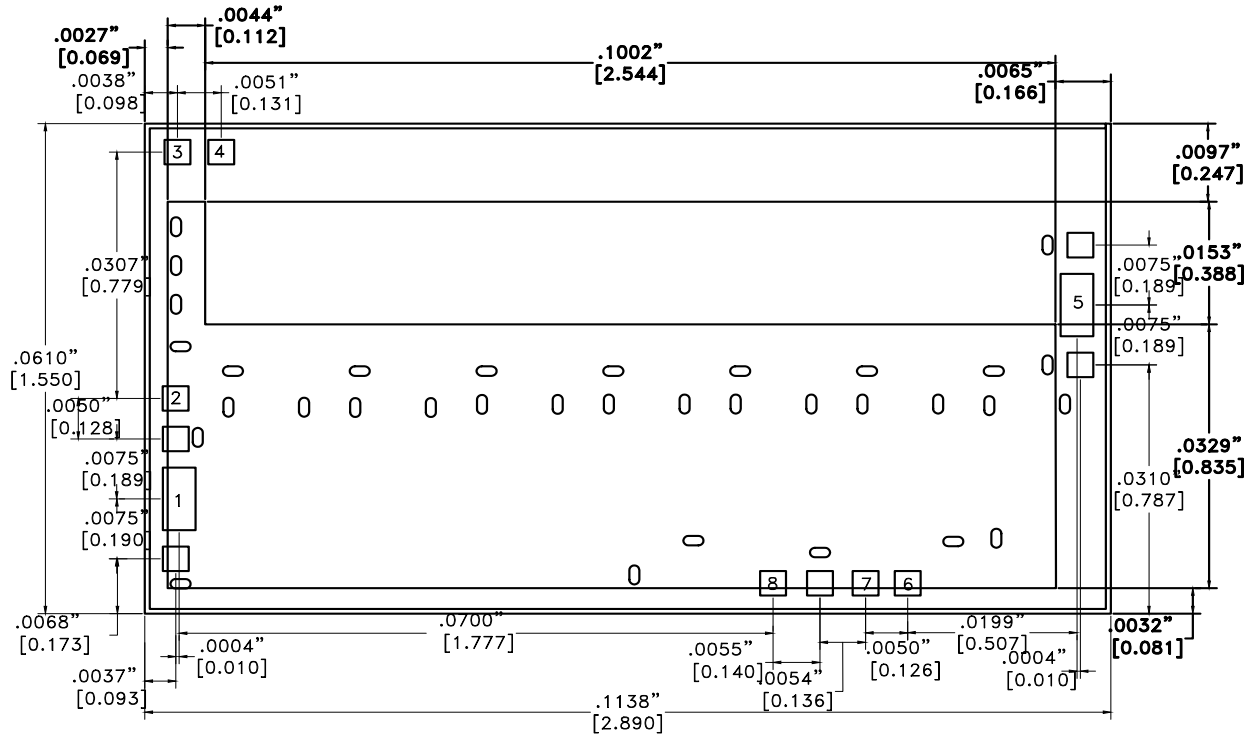

This die utilizes fragile air bridges. Any pick-up tools used must not contact the die in the cross hatched area.

Die Packaging Information ^[1]

Standard	Alternate
GP-2 (Gel Pack)	[2]

[1] Refer to the "Packaging Information" section on our website for die packaging dimensions.

[2] For alternate packaging information contact Analog Devices, Inc.

NOTES:

1. ALL DIMENSIONS ARE IN INCHES [MM]
2. DIE THICKNESS IS .0031"
3. TYPICAL BOND PAD IS .004" SQUARE
4. BOND PAD METALIZATION: GOLD
5. BACKSIDE METALIZATION: GOLD
6. BACKSIDE METAL IS GROUND
7. NO CONNECTION REQUIRED FOR UNLABELED BOND PADS
8. OVERALL DIE SIZE $\pm .002$ "

GaAs PHEMT MMIC 1 WATT POWER AMPLIFIER, DC - 22 GHz

Pad Descriptions

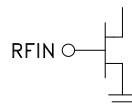
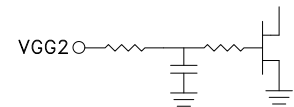
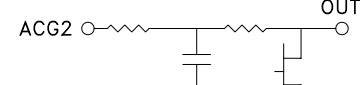
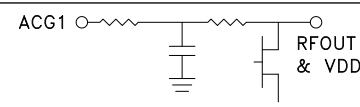
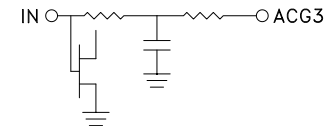
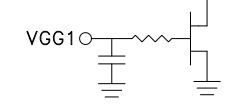
Pad Number	Function	Description	Interface Schematic
1	RFIN	This pad is DC coupled and matched to 50 Ohms. Blocking capacitor is required.	
2	VGG2	Gate control 2 for amplifier. Attach bypass capacitors per application circuit herein. For nominal operation +3.5V should be applied to Vgg2.	
4, 7	ACG2, ACG4	Low frequency termination. Attach bypass capacitors per application circuit herein.	
3	ACG1	Low frequency termination. Attach bypass capacitors per application circuit herein.	
5	RFOUT & VDD	RF output for amplifier. Connect DC bias (Vdd) network to provide drain current (Idd). See application circuit herein.	
6	ACG3	Low frequency termination. Attach bypass capacitor per application circuit herein.	
8	VGG1	Gate control 1 for amplifier. Attach bypass capacitor per application circuit herein. Please follow "MMIC Amplifier Biasing Procedure" application note.	
Die Bottom	GND	Die bottom must be connected to RF/DC ground.	

**GaAs PHEMT MMIC
1 WATT POWER AMPLIFIER, DC - 22 GHz**

Assembly Diagram

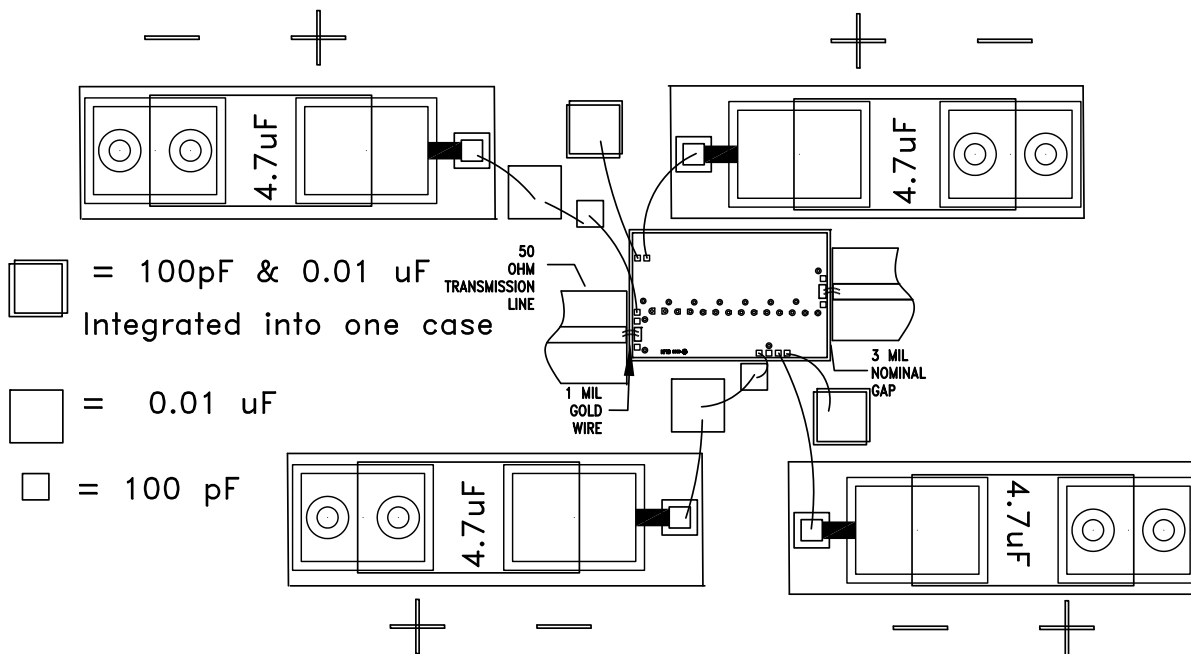

Application Circuit

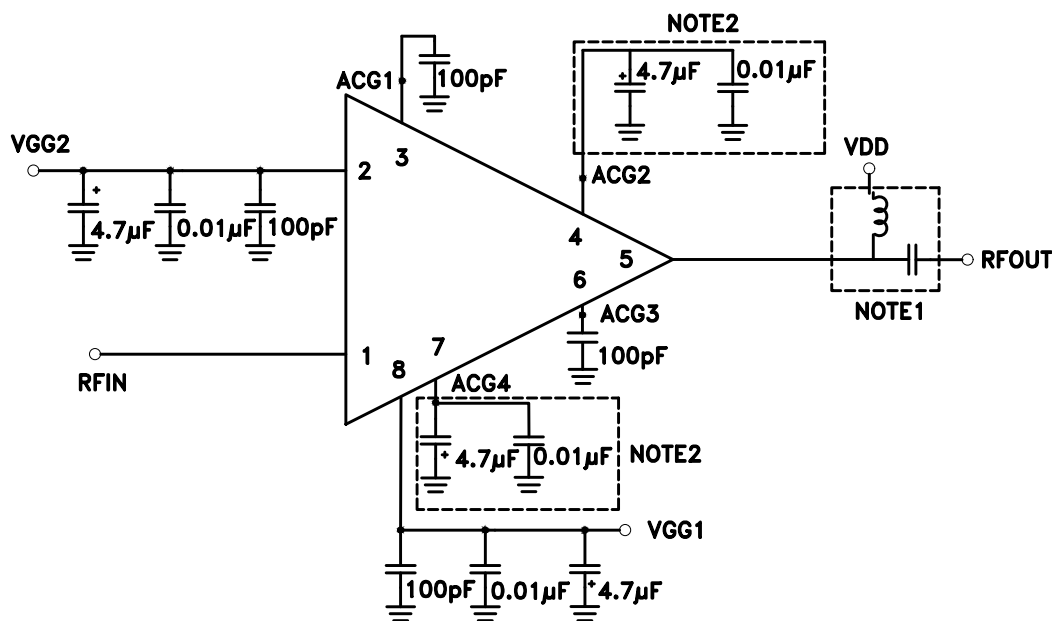

NOTE 1: Drain Bias (Vdd) must be applied through a broadband bias tee or external bias network with low resistance.
NOTE 2: Optional Capacitors to be used if part is to be operated below 200MHz.

GaAs PHEMT MMIC 1 WATT POWER AMPLIFIER, DC - 22 GHz

Mounting & Bonding Techniques for Millimeterwave GaAs MMICs

The die should be attached directly to the ground plane eutectically or with conductive epoxy (see HMC general Handling, Mounting, Bonding Note).

50 Ohm Microstrip transmission lines on 0.127mm (5 mil) thick alumina thin film substrates are recommended for bringing RF to and from the chip (Figure 1). If 0.254mm (10 mil) thick alumina thin film substrates must be used, the die should be raised 0.150mm (6 mils) so that the surface of the die is coplanar with the surface of the substrate. One way to accomplish this is to attach the 0.102mm (4 mil) thick die to a 0.150mm (6 mil) thick molybdenum heat spreader (moly-tab) which is then attached to the ground plane (Figure 2).

Microstrip substrates should be placed as close to the die as possible in order to minimize bond wire length. Typical die-to-substrate spacing is 0.076mm to 0.152 mm (3 to 6 mils).

Handling Precautions

Follow these precautions to avoid permanent damage.

Storage: All bare die are placed in either Waffle or Gel based ESD protective containers, and then sealed in an ESD protective bag for shipment. Once the sealed ESD protective bag has been opened, all die should be stored in a dry nitrogen environment.

Cleanliness: Handle the chips in a clean environment. DO NOT attempt to clean the chip using liquid cleaning systems.

Static Sensitivity: Follow ESD precautions to protect against ESD strikes.

Transients: Suppress instrument and bias supply transients while bias is applied. Use shielded signal and bias cables to minimize inductive pick-up.

General Handling: Handle the chip along the edges with a vacuum collet or with a sharp pair of bent tweezers. The surface of the chip may have fragile air bridges and should not be touched with vacuum collet, tweezers, or fingers.

Mounting

The chip is back-metallized and can be die mounted with AuSn eutectic preforms or with electrically conductive epoxy. The mounting surface should be clean and flat.

Eutectic Die Attach: A 80/20 gold tin preform is recommended with a work surface temperature of 255 °C and a tool temperature of 265 °C. When hot 90/10 nitrogen/hydrogen gas is applied, tool tip temperature should be 290 °C. DO NOT expose the chip to a temperature greater than 320 °C for more than 20 seconds. No more than 3 seconds of scrubbing should be required for attachment.

Epoxy Die Attach: Apply a minimum amount of epoxy to the mounting surface so that a thin epoxy fillet is observed around the perimeter of the chip once it is placed into position. Cure epoxy per the manufacturer's schedule.

Wire Bonding

RF bonds made with two 1 mil wires are recommended. These bonds should be thermosonically bonded with a force of 40-60 grams. DC bonds of 0.001" (0.025 mm) diameter, thermosonically bonded, are recommended. Ball bonds should be made with a force of 40-50 grams and wedge bonds at 18-22 grams. All bonds should be made with a nominal stage temperature of 150 °C. A minimum amount of ultrasonic energy should be applied to achieve reliable bonds. All bonds should be as short as possible, less than 12 mils (0.31 mm).

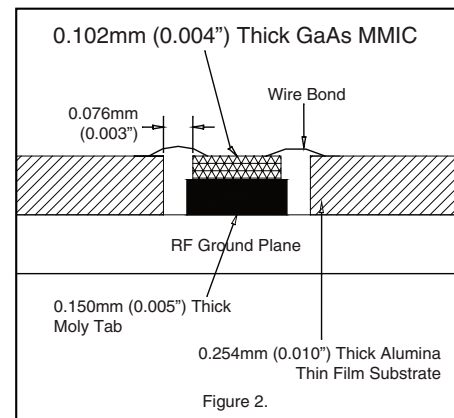
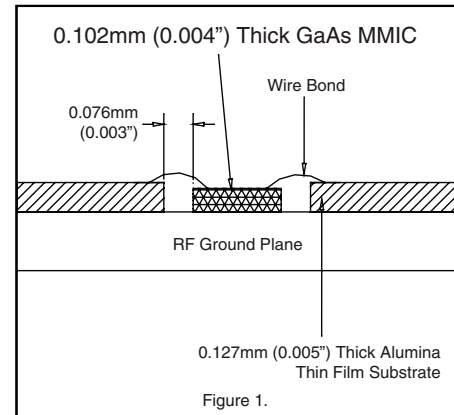

**GaAs PHEMT MMIC
1 WATT POWER AMPLIFIER, DC - 22 GHz**

Notes:

Looking for pricing, stock, or lifecycle information?

Click below to explore more details on WIN SOURCE:

 [View HMC797A-SX on WIN SOURCE](#)

 [Analog Devices Inc. Information](#)

Optimize Your Supply Chain with WIN SOURCE Solutions

-  Global Sourcing Solution
-  Obsolete Management
-  Cost Control Management
-  Shortage Management
-  Alternative Solution
-  Excess Inventory Management