



COAXIAL

Medium High Power Amplifier **ZHL-32A+**

50Ω 0.05 to 130 MHz

FEATURES

- Medium High Power, +29 dBm min.
- High IP3, +38 dBm typ.



Generic photo used for illustration purposes only

APPLICATIONS

- HF/VHF
- Instrumentation
- Communication Systems
- Laboratory

Model No.	ZHL-32A+	ZHL-32A-S+
Case Style	S32	
Connectors	BNC	SMA

+RoHS Compliant
 The +Suffix identifies RoHS Compliance.
 See our website for methodologies and qualifications

ELECTRICAL SPECIFICATIONS

Parameter	Frequency (MHz)	Min.	Typ.	Max.	Units
Frequency Range		0.05		130	MHz
Gain	0.05 - 130	25			dB
Gain Flatness	0.05 - 130			±1.0	dB
Output Power at 1dB compression	0.05 - 130	+29			dBm
Output third order intercept point	0.05 - 130		+38		dBm
Noise Figure	0.05 - 130		10		dB
Input VSWR	0.05 - 130		2.0		:1
Output VSWR	0.05 - 130		2.0		:1
DC Supply Voltage			+24		V
Supply Current				0.6	A

Open load is not recommended, potentially can cause damage.
 With no load derate max input power by 20 dB

ABSOLUTE MAXIMUM RATINGS

Parameter	Ratings
Operating Temperature	-20°C to +65°C
Storage Temperature	-55°C to +100°C
DC Voltage	+25V Max.
RF Input Power (no damage)	+10 dBm

Permanent damage may occur if any of these limits are exceeded.





COAXIAL

Medium High Power Amplifier ZHL-32A+

50Ω 0.05 to 130 MHz

OUTLINE DRAWING

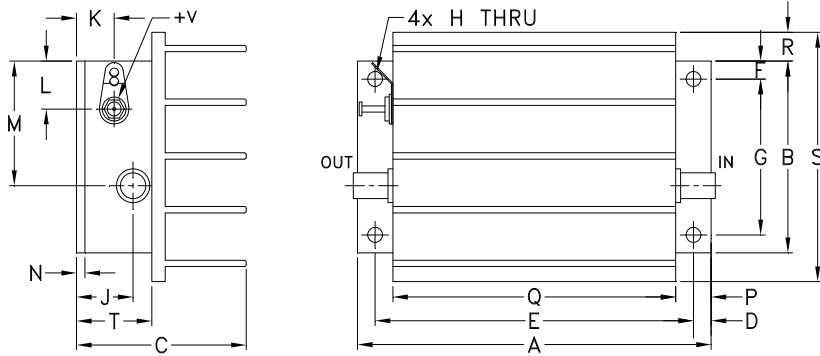

MOUNTING INFORMATION FOR MODELS WITHOUT HEATSINK

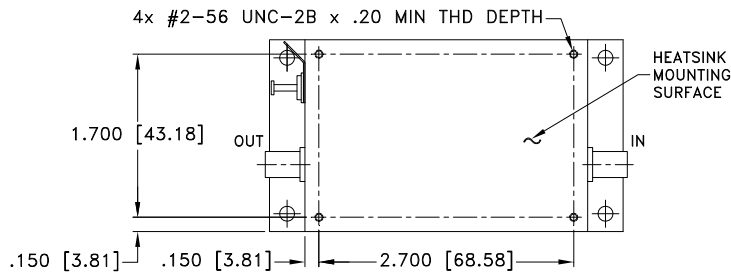

OUTLINE DIMENSIONS (Inch/mm)

A	B	C	D	E	F	G	H	J	K	L	M	N	P	Q	R	S	T	wt	
3.75	2.00	1.80	.19	3.375	.19	1.625	.144	.50	.40	.50	1.30	.10	.38	3.00	.30	2.60	.80	grams	
95.25	50.80	45.72	4.83	85.73	4.83	41.28	3.66	12.70	10.16	12.70	33.02	2.54	9.65	76.20	7.62	66.04	20.32	220.0	
																		wt. w/o heat sink	150



COAXIAL

Medium High Power Amplifier ZHL-32A+

50Ω 0.05 to 130 MHz

TYPICAL PERFORMANCE DATA/CURVES

FREQUENCY (MHz)	GAIN (dB)			DIRECTIVITY (dB)			VSWR (:1)		NOISE FIGURE (dB)	POUT at 1 dB COMPR. (dBm)
	23V	24V	24.5V	23V	24V	24.5V	IN	OUT	24V	24V
0.05	26.65	26.67	26.69	15.10	15.10	15.10	1.02	2.00	-	32.21
0.14	27.27	27.30	27.31	13.80	13.80	13.80	1.03	1.65	-	32.68
0.68	27.41	27.44	27.45	13.50	13.50	13.40	1.04	1.58	-	32.83
3.20	27.57	27.60	27.63	13.10	13.10	13.20	1.08	1.62	-	32.99
15.30	27.45	27.48	27.49	13.30	13.20	13.20	1.20	1.61	5.85	32.76
46.70	27.12	27.16	27.18	13.50	13.50	13.40	1.38	1.52	6.00	31.88
56.70	27.18	27.21	27.24	13.40	13.50	13.40	1.39	1.56	6.04	31.83
66.70	27.35	27.38	27.40	13.20	13.30	13.30	1.36	1.56	6.04	31.43
73.40	27.55	27.59	27.60	13.00	13.10	13.10	1.33	1.57	6.02	31.30
80.00	27.76	27.81	27.83	13.00	13.00	12.90	1.30	1.56	5.99	31.33
90.00	28.00	28.04	28.06	12.90	12.70	12.80	1.28	1.50	6.00	30.98
100.00	27.97	28.03	28.05	12.90	12.90	13.00	1.29	1.39	6.08	30.47
110.00	27.75	27.80	27.83	13.20	13.10	13.20	1.32	1.29	6.19	30.06
120.00	27.32	27.37	27.40	13.60	13.60	13.50	1.36	1.19	6.31	30.17
130.00	26.64	26.71	26.72	14.20	14.20	14.20	1.43	1.15	6.45	29.82

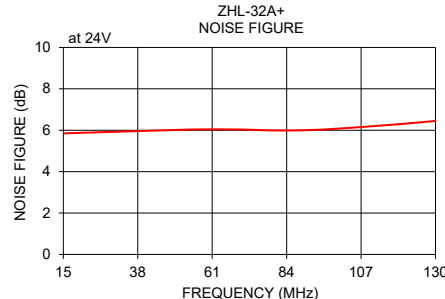
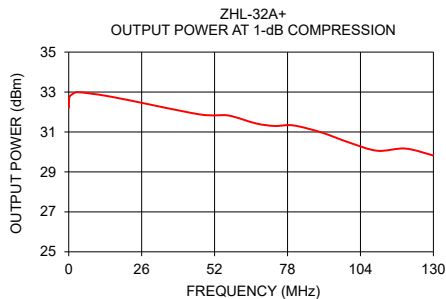
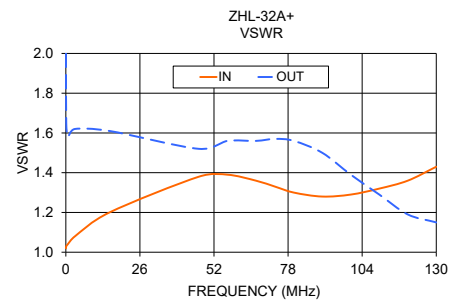
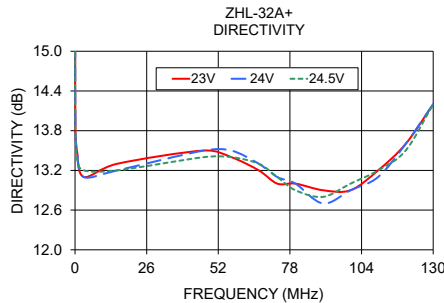
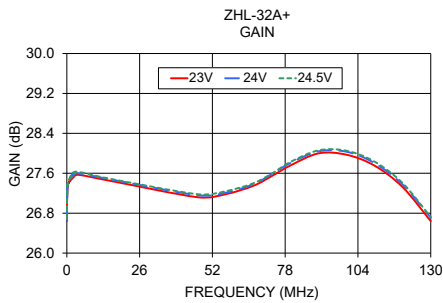



NOTES

- A. Performance and quality attributes and conditions not expressly stated in this specification document are intended to be excluded and do not form a part of this specification document.
- B. Electrical specifications and performance data contained in this specification document are based on Mini-Circuit's applicable established test performance criteria and measurement instructions.
- C. The parts covered by this specification document are subject to Mini-Circuits standard limited warranty and terms and conditions (collectively, "Standard Terms"); Purchasers of this part are entitled to the rights and benefits contained therein. For a full statement of the standard terms and the exclusive rights and remedies thereunder, please visit Mini-Circuits' website at www.minicircuits.com/terms/viewterm.html



Looking for pricing, stock, or lifecycle information?

Click below to explore more details on WIN SOURCE:

-  [View ZHL-32A+ on WIN SOURCE](#)
-  [Mini-Circuits Information](#)

Optimize Your Supply Chain with WIN SOURCE Solutions

-  Global Sourcing Solution
-  Obsolete Management
-  Cost Control Management
-  Shortage Management
-  Alternative Solution
-  Excess Inventory Management