



SUPER ULTRA

Wideband Amplifier

ZVA-183W-S+ ZVA-183WX-S+

50Ω 0.1 to 18 GHz

FEATURES

- Wideband, 0.1 to 18 GHz
- High IP3, 36 dBm typ.
- High power output, +26 dBm
- High flat gain, 27±2 dB typ.

APPLICATIONS

- Radar and military
- Test instrumentation
- Satellite repeaters
- Communication

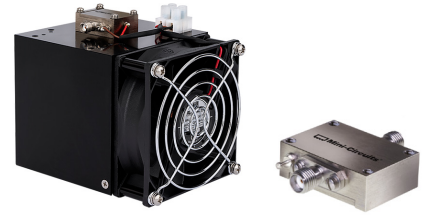

Generic photo used for illustration purposes only

Model No.	ZVA-183W-S+	ZVA-183WX-S+ [▲]
Case Style	CP1755	
Connectors	SMA	

+RoHS Compliant
The +Suffix identifies RoHS Compliance. See our web site for RoHS Compliance methodologies and qualifications

PRODUCT OVERVIEW

ZVA-183W-S+ is a Class-A, four stage, unconditionally stable amplifier. It features a ruggedized case, available with and without a heat sink/fan, and has the capability to withstand accidental open or short at output and is protected against reverse bias protection for added reliability under difficult conditions.

ELECTRICAL SPECIFICATIONS AT 25°C

Parameter	Condition (MHz)	ZVA-183W-S+ ZVA-183WX-S+ [▲]			Units
		Min.	Typ.	Max.	
Frequency Range		100	—	18000	MHz
Gain	100 - 6000	25	29	34	dB
	6000 - 18000	24	27	33	
Gain Flatness	100 - 6000	—	±2	±2.5	dB
	6000 - 18000	—	±1.0	±1.8	
Output Power at 1dB compression	100 - 6000	24.5	27	—	dBm
	6000 - 18000	24.5	26	—	
Noise Figure	500 - 18000	—	3	6	dB
Output third order intercept point	100 - 6000	—	+36	—	dBm
	6000 - 18000	—	+33	—	
Input VSWR	100 - 18000	—	1.3	2.0	:1
Output VSWR	100 - 18000	—	1.6	2.2	:1
DC Supply Voltage		14	15*	16	V
Supply Current [†]		—	625	700	mA

[†] Power Supply should be capable of delivering 1A at start-up.
* Recommended Operating Voltage.

[▲] Heat sink not included. Alternative heat sinking and heat removal must be provided by the user to limit maximum base-plate temperature to 85°C, in order to ensure proper performance. For reference, this requires thermal resistance of user's external heat sink to be 1.79°C/W max.

MAXIMUM RATINGS

Parameter	Ratings
Operating Temperature	ZVA-183W-S+ -55°C to 60°C ambient
	ZVA-183WX-S+ -55°C to 85°C base plate temp.
Storage Temperature	-65°C to 150°C
DC Voltage	18V
CW Input RF Power (no damage)	+20 dBm

Permanent damage may occur if any of these limits are exceeded.





SUPER ULTRA

Wideband Amplifier

ZVA-183W-S+ ZVA-183WX-S+

OUTLINE DRAWING FOR MODELS WITH HEATSINK

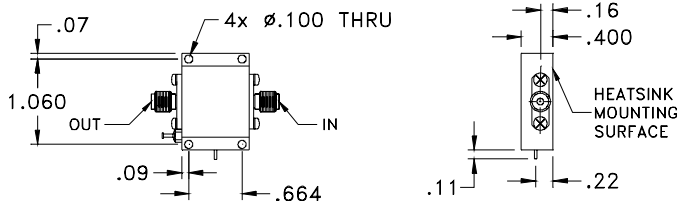
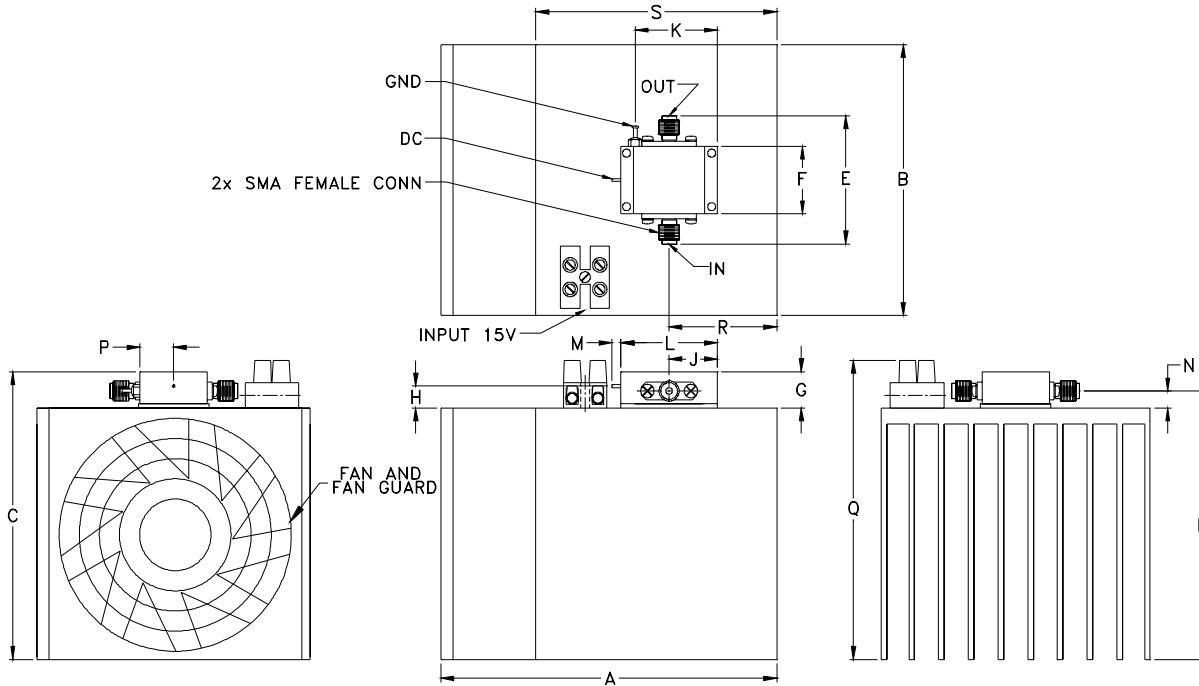

HEAT SPREADER PLATE AND MOUNTING HARDWARE INCLUDED WITH MODELS WITHOUT HEATSINK

OUTLINE DIMENSIONS (MM/INCH)

A	B	C	D	E	F	G	H	J	K	L	M	N	P	Q	R	S	wt
4.18	3.36	3.57	3.33	1.59	.840	.45	0.27	.600	1.02	1.200	.11	.21	.420	3.71	1.34	3.00	grams*
106.17	85.34	90.68	84.58	40.39	21.34	11.43	6.86	15.24	25.91	30.48	2.79	5.33	10.67	94.23	34.04	76.20	480

*18.2 grams without heatsink





SUPER ULTRA

Wideband Amplifier

ZVA-183W-S+ ZVA-183WX-S+

TYPICAL PERFORMANCE DATA/CURVES

Frequency (MHz)	Gain (dB)	Directivity (dB)	VSWR (:1)		Pout at 1 dB Compr. (dBm)	Noise Figure (dB)	IP3 (dB)
	15V	15V	IN	OUT	15V	15V	15V
100	30.46	45.70	1.30	1.40	25.84	8.87	36.63
1000	30.45	47.11	1.30	1.68	27.32	4.51	40.53
2000	28.64	37.01	1.27	1.63	27.39	4.02	39.80
3000	28.93	31.34	1.25	1.26	27.73	3.46	40.28
4000	27.44	41.05	1.20	1.08	27.19	3.19	39.35
5000	28.01	42.69	1.18	1.17	27.79	2.98	40.31
6000	27.10	31.48	1.13	1.07	27.46	2.69	39.44
7000	28.14	36.44	1.14	1.14	27.70	2.37	39.20
8000	27.69	42.96	1.11	1.21	27.25	2.57	38.18
9000	28.01	40.06	1.18	1.23	27.24	2.73	37.89
10000	27.25	40.50	1.19	1.15	27.24	3.19	37.06
11000	26.63	42.63	1.23	1.15	26.59	3.53	36.23
12000	26.73	40.00	1.40	1.42	25.87	3.75	35.52
14000	26.85	28.10	1.28	1.49	25.97	3.82	34.24
16000	27.57	35.72	1.11	1.31	25.90	4.25	33.98
18000	26.16	30.26	1.23	1.29	26.12	4.60	32.60

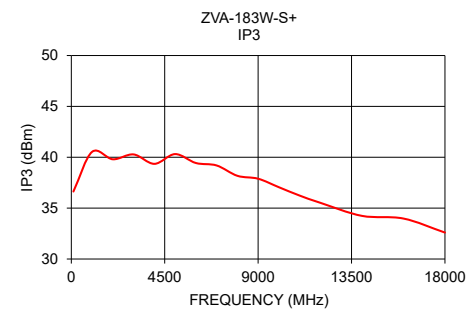
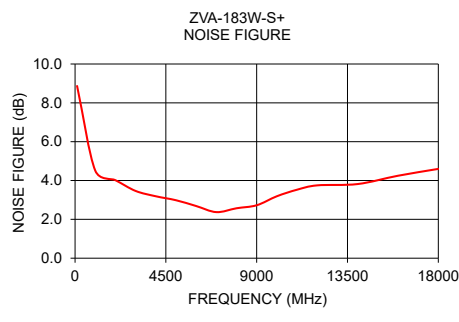
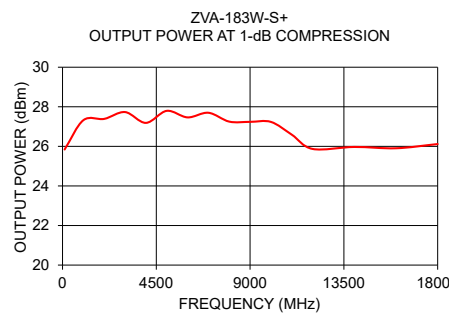
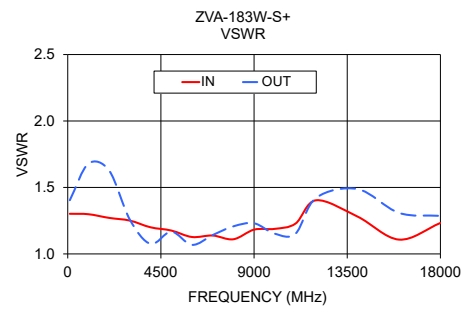
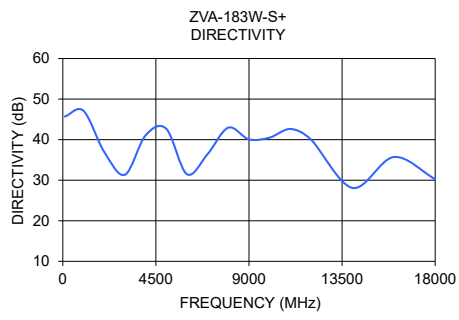
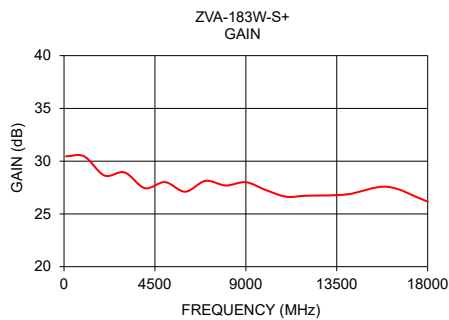

NOTES

- A. Performance and quality attributes and conditions not expressly stated in this specification document are intended to be excluded and do not form a part of this specification document.
- B. Electrical specifications and performance data contained in this specification document are based on Mini-Circuit's applicable established test performance criteria and measurement instructions.
- C. The parts covered by this specification document are subject to Mini-Circuits standard limited warranty and terms and conditions (collectively, "Standard Terms"); Purchasers of this part are entitled to the rights and benefits contained there in. For a full statement of the standard. Terms and the exclusive rights and remedies thereunder, please visit Mini-Circuits' website at www.minicircuits.com/MCLStore/terms.jsp



Looking for pricing, stock, or lifecycle information?

Click below to explore more details on WIN SOURCE:

 [View ZVA-183W-S+ on WIN SOURCE](#)

 [Mini-Circuits Information](#)

Optimize Your Supply Chain with WIN SOURCE Solutions

-  Global Sourcing Solution
-  Obsolete Management
-  Cost Control Management
-  Shortage Management
-  Alternative Solution
-  Excess Inventory Management