



COAXIAL

Medium Power Amplifier

ZHL-10M4G21W0+
ZHL-10M4G21W0X+

Mini-Circuits

50Ω 10 to 4200 MHz Broadband 1.6W SMA-Female

THE BIG DEAL

- Broadband, 10 to 4200MHz
- High Gain, 37dB typ.
- High P1dB, +32dBm, typ.
- High OIP3, +44dBm typ.

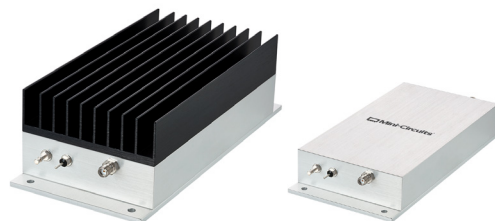

With heatsink

Without heatsink

Generic photo used for illustration purposes only

APPLICATIONS

- Communication Systems
- R&D, Production, and OTA Test Systems
- Test & Measurement Equipment
- General Laboratory Applications

FUNCTIONAL DIAGRAM

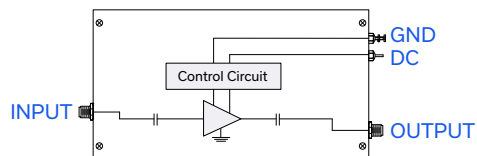

PRODUCT OVERVIEW

The ZHL-10M4G21W0(X)+ is a medium power broadband amplifier providing more than 1W of output power with a typical small signal gain of 37dB over the 10 to 4200 MHz frequency band. The amplifier uses state-of-the-art semiconductor technology and can be used in a wide range of applications. A single supply voltage ensures ease of operation. The amplifier is made with a rugged aluminum housing and can be supplied with or without a heatsink.

KEY FEATURES

Features	Advantages
Extremely Broadband, 10 to 4200 MHz and High Power, 1.6W	One single amplifier that covers the entire frequency band delivering rated power.
High Gain, 37 dB Typ.	High gain allows low drive levels to achieve rated output power which can be obtained from many standard lab generators.
Rugged by design	Accidental reversing of the polarity of the power supply or accidental open/short (delivering P _{1dB} power) will not damage the amplifier.
High OIP3, +44 dBm Typ.	High OIP3 makes the amplifier suitable for applications requiring high linearity such as digitally modulated signals.
Rugged enclosure	The solid aluminum enclosure makes the amplifier usable for any application from industrial, to laboratory environments.

REV. OR
ECO-017275
ZHL-10M4G21W0+
MCL NY
250228





COAXIAL

Medium Power Amplifier

ZHL-10M4G21W0+
ZHL-10M4G21W0X+

Mini-Circuits

50Ω 10 to 4200 MHz Broadband 1.6W SMA-Female

ELECTRICAL SPECIFICATIONS AT $T_{MOUNTINGBASE} = +25^{\circ}C, V_{DC} = +28V$

Parameter	Symbol	Condition	Min.	Typ.	Max.	Units
Frequency Range	f		10		4200	MHz
Small Signal Gain	G_{SS}		31	37	40	dB
Small Signal Gain Flatness	$G_{SS-FLAT}$			± 1.2	± 1.6	dB
Output Power at 1dB compression	P_{1dB}		28	32		dBm
Output Power at 3dB compression	P_{3dB}		29	34		dBm
Noise Figure	NF			6.5		dB
Output Third Order Intercept Point	OIP3	$P_{OUT} = +20dBm/tone$		44		dBm
Input VSWR	I-VSWR			1.3	2.4	:1
Output VSWR	O-VSWR			1.5	2.4	:1
DC Supply Voltage	V_{DC}		26	28	30	V
Supply Current	I_{DC}	@ P_{3dB}		0.8	1.0	A



COAXIAL

Medium Power Amplifier

ZHL-10M4G21W0+
ZHL-10M4G21W0X+

Mini-Circuits

50Ω 10 to 4200 MHz Broadband 1.6W SMA-Female

TYPICAL PERFORMANCE DATA AT $T_{MOUNTINGBASE} = 25^{\circ}C, V_{DC} = 28V, 50 OHM$

Small Signal Gain vs. Frequency

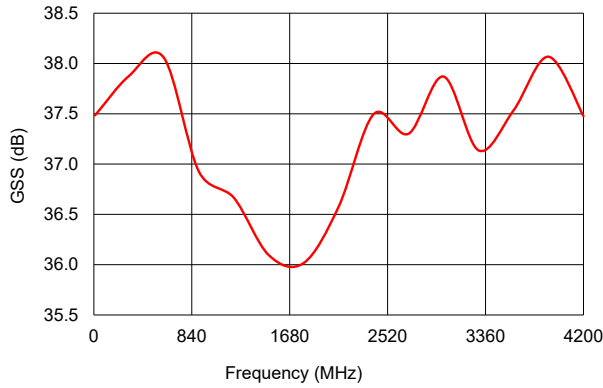

VSWR vs. Frequency

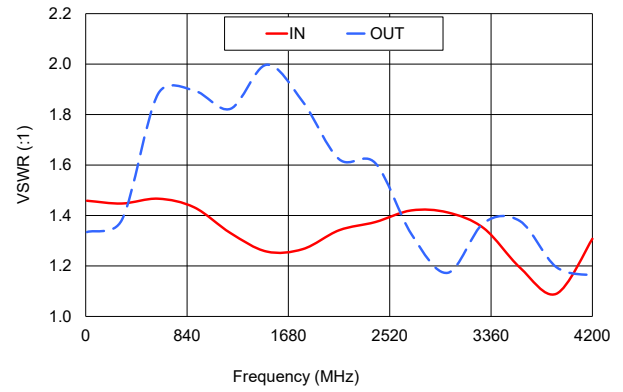

Output Power at 1dB Compression vs. Frequency

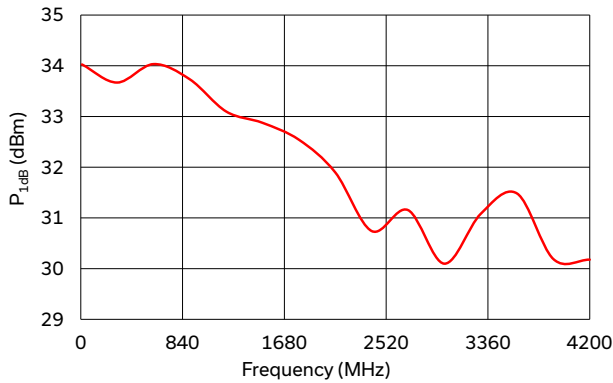

Output Power at 3dB Compression vs. Frequency

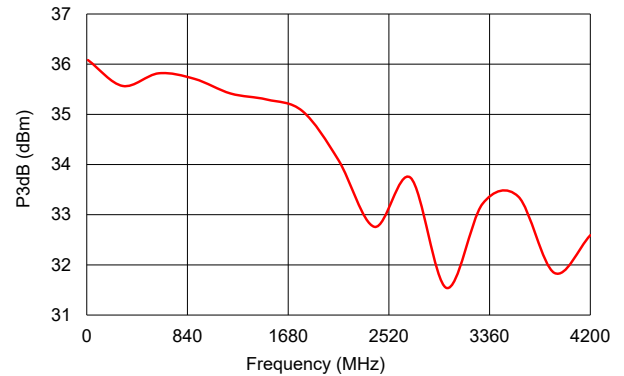

Noise Figure vs. Frequency

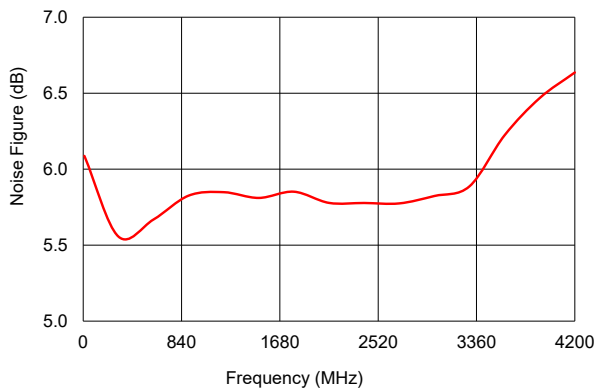

Output Third Order Intercept Point vs. Frequency

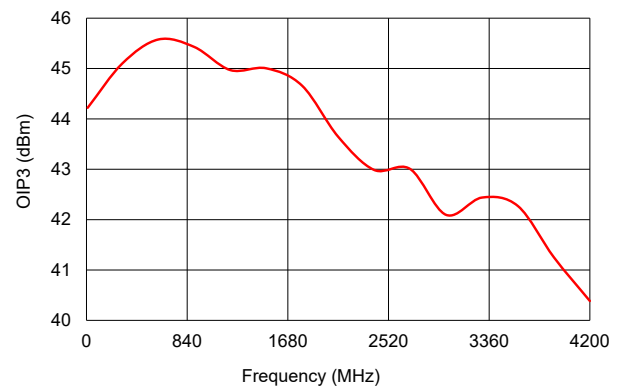



COAXIAL

Medium Power Amplifier

ZHL-10M4G21W0+
ZHL-10M4G21W0X+

Mini-Circuits

50Ω 10 to 4200 MHz Broadband 1.6W SMA-Female

ABSOLUTE MAXIMUM RATINGS

Parameter	Ratings	
Operating Temperature	ZHL-10M4G21W0+	T _{AMBIENT} : -20 °C to +65 °C
	ZHL-10M4G21W0X+	T _{MOUNTINGBASE} : -20 °C to +85 °C
Storage Temperature	-55 °C to +100 °C	
No damage with an open or short at P _{OUT} = +30 dBm CW for 2 minutes max		
RF Input Power (no damage)	+5 dBm	
DC Operating Voltage	± 30 V	

Permanent damage may occur if any of these limits are exceeded.

DETERMINING MAXIMUM THERMAL RESISTANCE OF USERS' EXTERNAL HEAT SINK

<i>MAXIMUM THERMAL RESISTANCE</i>	$= \frac{\text{MAXIMUM OPERATING CASE TEMP} - \text{MAXIMUM USER AMBIENT TEMP}}{\text{POWER DISSIPATION}}$
Example:	<p>MAXIMUM MOUNTING BASE TEMP = +85 °C (CHECK MAXIMUM RATINGS TABLE FOR THIS VALUE)</p> <p>MAXIMUM USER AMBIENT TEMP = +65 °C (USER DEFINED)</p> <p>POWER DISSIPATION = 30 WATTS (CHECK MAXIMUM RATINGS TABLE FOR THIS VALUE)</p> <p>THEN MAXIMUM ALLOWABLE THERMAL RESISTANCE = 0.66 °C/W</p>



COAXIAL

Medium Power Amplifier

ZHL-10M4G21W0+ ZHL-10M4G21W0X+

Mini-Circuits

50Ω 10 to 4200 MHz Broadband 1.6W SMA-Female

COAXIAL CONNECTIONS

IN (RF IN)	SMA-Female
OUT (RF OUT)	SMA-Female

CASE STYLE DRAWING WITH HEATSINK (ZHL-10M4G21W0+)

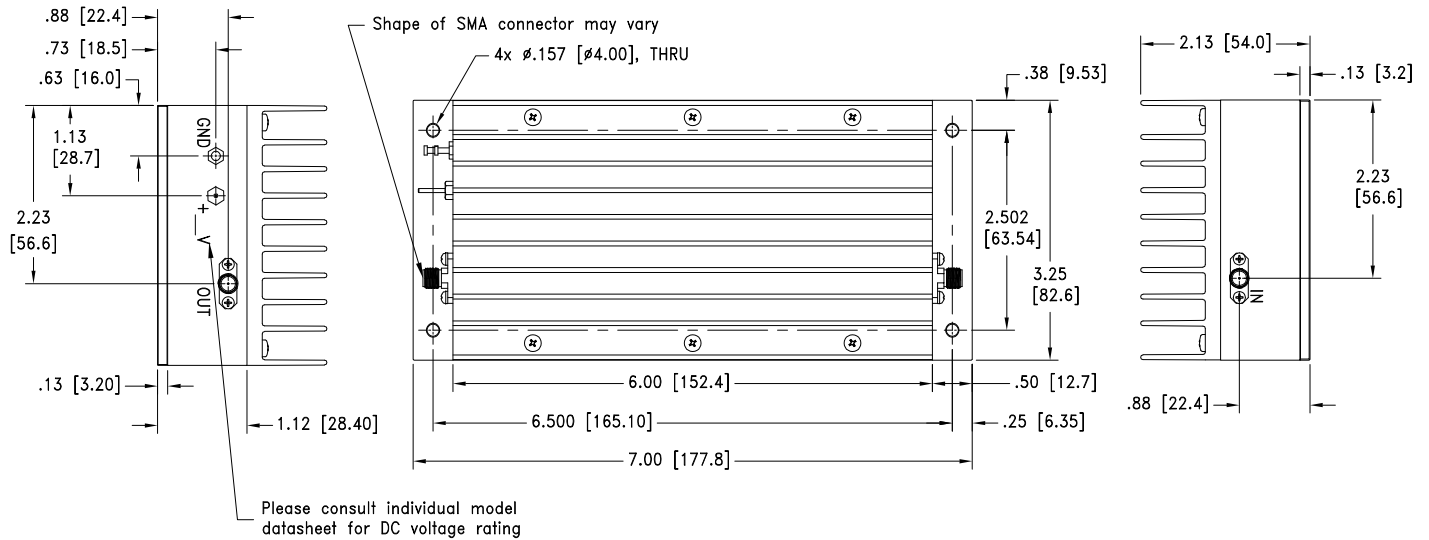

CASE STYLE DRAWING WITHOUT HEATSINK (ZHL-10M4G21W0X+)

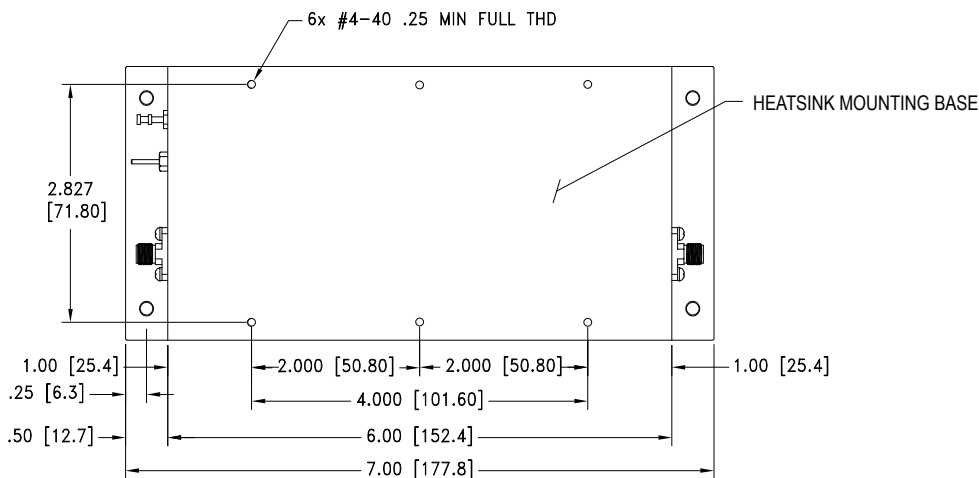

Weight: 900.0 grams. Weight without heatsink: 600.0 grams
 Dimensions are in inches [mm]. Tolerances: 2 Pl. \pm .03; 3 Pl. \pm .015 Inch





COAXIAL

Medium Power Amplifier

ZHL-10M4G21W0+
ZHL-10M4G21W0X+

Mini-Circuits

50Ω 10 to 4200 MHz Broadband 1.6W SMA-Female

ADDITIONAL INFORMATION IS AVAILABLE ON OUR DASHBOARD.

Performance Data	Table
	Graphs
	S-Parameter (S2P Files) Data Set (.zip file)
RoHs Status	Compliant
Environmental Ratings	ENV23T3

ORDERING INFORMATION

Model No. Links	ZHL-10M4G21W0+	ZHL-10M4G21W0X+
Option	With heatsink	Without heatsink
Case Style	U36	
Connector	IN (SMA-Female) / OUT (SMA-Female)	

NOTES

- A. Performance and quality attributes and conditions not expressly stated in this specification document are intended to be excluded and do not form a part of this specification document.
- B. Electrical specifications and performance data contained in this specification document are based on Mini-Circuit's applicable established test performance criteria and measurement instructions.
- C. The parts covered by this specification document are subject to Mini-Circuits standard limited warranty and terms and conditions (collectively, "Standard Terms"); Purchasers of this part are entitled to the rights and benefits contained therein. For a full statement of the standard terms and the exclusive rights and remedies thereunder, please visit Mini-Circuits' website at www.minicircuits.com/terms/viewterm.html



Looking for pricing, stock, or lifecycle information?

Click below to explore more details on WIN SOURCE:

 [View ZHL-10M4G21W0+](#) on WIN SOURCE

 [Mini-Circuits](#) Information

Optimize Your Supply Chain with WIN SOURCE Solutions

-  Global Sourcing Solution
-  Obsolete Management
-  Cost Control Management
-  Shortage Management
-  Alternative Solution
-  Excess Inventory Management