

Multilayer Varistor

For ESD pulse [Automotive grade]

EZJZ-M, EZJP-M series

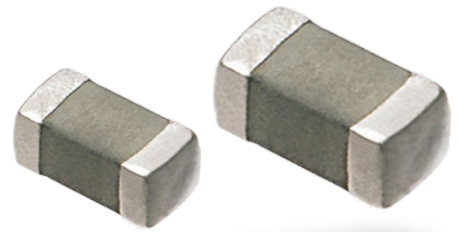

Features

- Excellent ESD suppression due to original advanced material technology
- Having large electrostatic resistance meeting IEC61000-4-2, ISO10605
- Having no polarity (bipolar) facilitated replacing Zener Diodes. Capable of replacing 2 Zener Diodes and 1 Capacitor
- Lead-free plating terminal electrodes enabling great solderability
- Wide range of products is available by adopting multilayer structure, meeting various needs
- RoHS compliant
- Automotive grade (this product can be tested under the conditions according to AEC-Q200 and the test results can be submitted.)

Explanation of part numbers

1	2	3	4	5	6	7	8	9	10	11	
E	Z	J	P	0	V	2	7	0	E	M	Example
Product code									Automotive grade		

Code	Series	Code	Dimensions (mm) (inch)	Code	Packaging style	Nominal varistor voltage			
Z	EZJZ			V	0402, 0603 Punched carrier taping 0805	The first and second digits denote the first 2 numbers of the varistor voltage and the third digit indicates the number of zeros following. The decimal point denotes in R.			
P	EZJP	0	1005 (0402)	Y	Embossed carrier tape				
		1	1608 (0603)			B	10 pF	F	68 pF
		2	2012 (0805)			R	20 pF	G	100 pF
						D	27 pF	H	150 pF
						E	47 pF	J	220 pF
						W	56 pF	K	330 pF

Construction

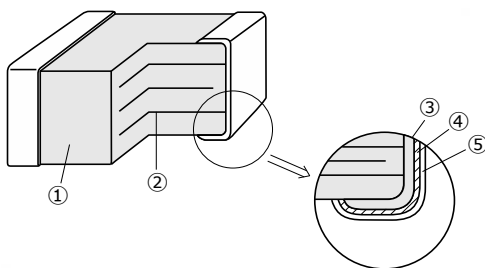

[Composition]

No.	Name
①	Zinc oxide-based ceramics
②	Internal electrode
③	Substrate electrode
④	Intermediate electrode
⑤	External electrode

Dimensions in mm (not to scale)

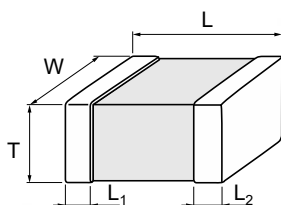

Size code	Size(inch)	L	W	T	L ₁ , L ₂
0	0402	1.00 ± 0.05	0.50 ± 0.05	0.50 ± 0.05	0.2 ± 0.1
1	0603	1.6 ± 0.1	0.8 ± 0.1	0.8 ± 0.1	0.3 ± 0.2
2	0805	2.0 ± 0.2	1.25 ± 0.2	1.25 ± 0.2	0.5 ± 0.25

Unit : mm

Multilayer Varistor (Automotive grade) / EZJZ-M, EZJP-M series

Features

Wide variety of products is available by adopting multilayer construction, which achieved wide range of usage, such as application to DC voltage lines and signal lines.

- Varistor voltage : 12 to 100 V (at 1 mA)
- Capacitance : 10 to 220 pF max. (at 1 MHz)

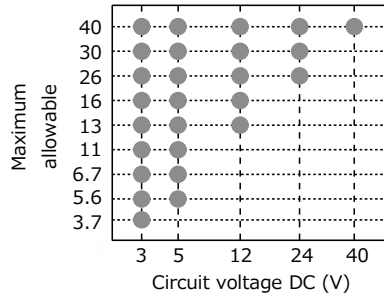

Recommended applications

- Engine ECU
- Various body ECU
- Communication line, such as CAN, LIN
- Audio, Navigation
- LED Light
- Control SW

Ratings and characteristics

Size (inch)	Part No.	Maximum allowable voltage DC (V)	Nominal varistor voltage at 1 mA (V)	Capacitance (pF)		Maximum peak current at 8/20 μs, 2 times (A)	Clamping Voltage at 8/20 μs (V)	Maximum ESD
				at 1 MHz	at 1 kHz			
0402	EZJP0V120JM	7.5	12 (9.6 to 14.4)	220 max. [150 typ.]	175 typ.	10	30 max. (1A)	IEC61000-4-2 150 pF/ 330 Ω Contact discharge 8 kV ²
	EZJP0V180HM	11	18 (14.4 to 21.6)	150 max. [120 typ.]	140 typ.	10	38 max. (1A)	
	EZJP0V220HM	13	22 (17.6 to 26.4)	150 max. [100 typ.]	116 typ.	10	48 max. (1A)	
	EZJP0V240JM	16	24 (21.6 to 28.8)	—	200 typ. ^{+10 %} _{-20 %}	10	48 max. (1A)	
	EZJP0V270GM	18	27 (21.6 to 32.4)	100 max. [85 typ.]	100 typ.	10	50 max. (1A)	
	EZJP0V270EM	18	27 (21.6 to 32.4)	47 max. [33 typ.]	37 typ.	4	50 max. (1A)	
	EZJP0V270RM	18	27 (21.6 to 32.4)	20 max. [15 typ.]	16.5 typ.	2	50 max. (1A)	
	EZJP0V270BM	18	27 (21.6 to 32.4)	10 max. [8 typ.]	10 typ.	—	—	
	EZJP0V330GM	25	33 (29.4 to 39.6)	100 max. [85 typ.]	100 typ.	10	58 max. (1A)	
	EZJP0V420WM	30	42 (33.6 to 50.4)	56 max. [40 typ.]	45 typ.	6	80 max. (1A)	
	EZJP0V650DM	40	65 (52.0 to 78.0)	27 max. [22 typ.]	33 typ.	2	120 max. (1A)	
EZJP0V101BM	30	100 (80 to 120)	10 max. [8 typ.]	10 typ.	—	—		
0603	EZJP1V120KM	7.5	12 (10.6 to 15.4)	330 max. [250 typ.]	290 typ.	20	30 max. (2A)	ISO10605 330 pF/ 2k Ω Contact discharge 25 kV
	EZJP1V180JM	11	18 (14.4 to 21.6)	220 max. [180 typ.]	210 typ.	20	38 max. (2A)	
	EZJP1V220JM	13	22 (17.6 to 26.4)	220 max. [160 typ.]	185 typ.	10	44 max. (2A)	
	EZJP1V270GM	18	27 (21.6 to 32.4)	100 max. [85 typ.]	100 typ.	10	52 max. (2A)	
	EZJP1V270EM	18	27 (21.6 to 32.4)	47 max. [33 typ.]	37 typ.	5	55 max. (2A)	
	EZJP1V270RM	18	27 (21.6 to 32.4)	20 max. [15 typ.]	16.5 typ.	2	60 max. (2A)	
	EZJP1V330GM	25	33 (29.4 to 39.6)	100 max. [85 typ.]	100 typ.	10	58 max. (2A)	
	EZJP1V420FM	30	42 (33.6 to 50.4)	68 max. [55 typ.]	63 typ.	8	80 max. (2A)	
	EZJP1V650DM	40	65 (52.0 to 78.0)	27 max. [22 typ.]	33 typ.	6	150 max. (2A)	
	EZJZ1V180JM	11	18 (14.4 to 21.6)	220 max. [180 typ.]	210 typ.	20	38 max. (2A)	
	EZJZ1V220JM	13	22 (19.8 to 24.2)	220 max. [160 typ.]	185 typ.	20	44 max. (2A)	
	EZJZ1V270GM	18	27 (25.4 to 30.8)	100 max. [85 typ.]	100 typ.	20	50 max. (2A)	
	EZJZ1V270EM	18	27 (25.4 to 30.8)	47 max. [33 typ.]	37 typ.	10	56 max. (2A)	
	EZJZ1V270RM	18	27 (25.4 to 30.8)	20 max. [15 typ.]	16.5 typ.	3	50 max. (1A)	
	EZJZ1V330GM	26	33 (30.6 to 37.4)	100 max. [85 typ.]	100 typ.	20	58 max. (2A)	
	EZJZ1V420FM	30	42 (37.8 to 46.2)	68 max. [55 typ.]	63 typ.	15	80 max. (2A)	
	EZJZ1V650DM	40	65 (58.5 to 71.5)	27 max. [22 typ.]	33 typ.	5	120 max. (2A)	
0805	EZJZ2Y390KM	31	39 (35.1 to 42.9)	330 max. [210 typ.]	250 typ.	80 ¹	67 max. (1A)	

- Operating temperature range : EZJP-M series -55 to 150 °C
EZJZ-M series -55 to 125 °C

- *1: Surge 1 time
- *2: 25kV for EZJP0V240JM
- * Recommend soldering method : Reflow soldering

[Terms]

Maximum allowable voltage	Maximum DC Voltage that can be applied continuously within the operating temperature range
Varistor voltage	Varistor starting voltage between terminals at DC 1 mA, also known as Breakdown voltage
Maximum peak current	Maximum current that can be withstood under the standard pulse 8/20 μs, 2 times based
Clamping voltage	The maximum voltage between two terminals with the specified impulse current (8/20 μs)
Maximum ESD	Maximum voltage that can be withstood under ESD

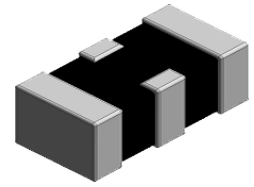

Multilayer Varistor

For ESD pulse [Automotive grade]

EZJPR-M series 2in1 type

Features

- Excellent ESD suppression due to original advanced material technology
- Reducing capacitance difference to 1.0 pF or less by the 2in1 structure and realizing a high communication signal quality
- Achieving both high ESD protection and EMC performance (ensuring high communication stability through EMC testing)
- Contributing to reducing environmental impact by reducing materials and energy used in customers' processes
- Having large electrostatic resistance meeting IEC61000-4-2, ISO10605
- Excellent BCI test withstanding
- Lead-free plating terminal electrodes enabling great solderability
- RoHS compliant
- Automotive grade (this product can be tested under the conditions according to AEC-Q200 and the test results can be submitted.)

Explanation of part numbers

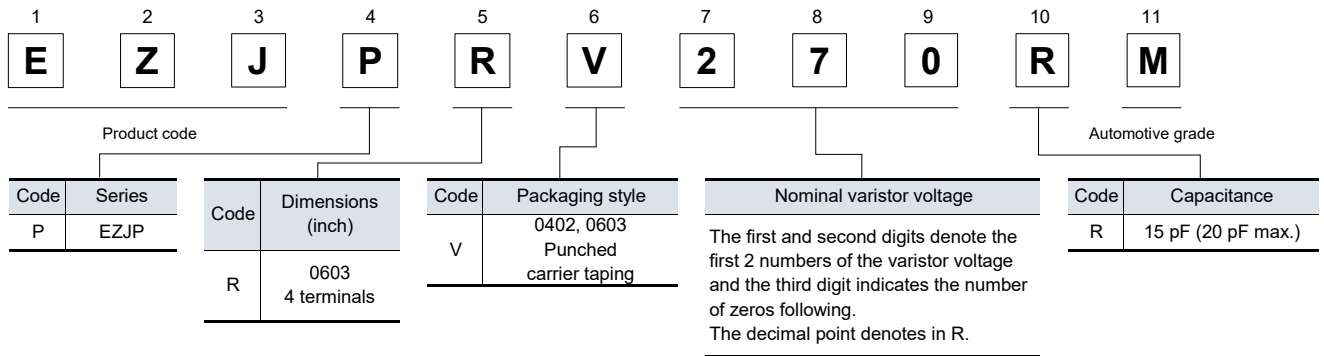

Construction

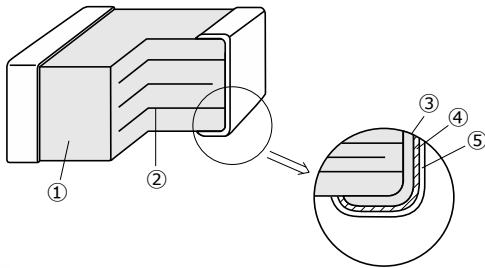

[Composition]

No.	Name	
①	Zinc oxide-based ceramics	
②	Internal electrode	
③	Terminal electrode	Substrate electrode
④		Intermediate electrode
⑤		External electrode

Dimensions in mm (not to scale)

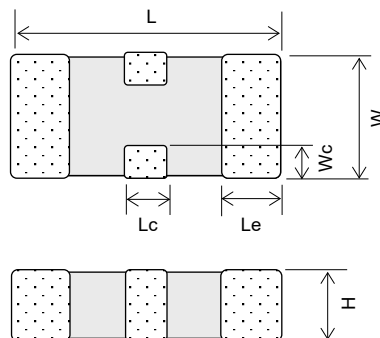

Size code	Size	L	W	H	Le	Lc	Wc
R	0603	1.60 ± 0.15	0.80 ± 0.10	0.70 max.	0.30 ± 0.15	0.30 ± 0.15	0.18 ± 0.10

Unit : mm

Equivalent circuit

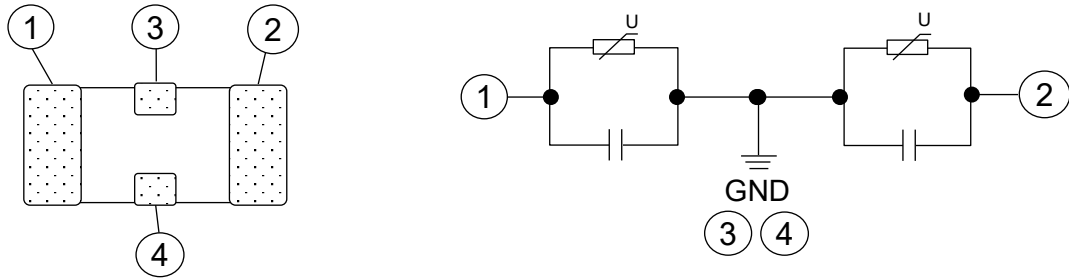

Application

Suitable component as ESD countermeasure for CAN-FD/CAN lines

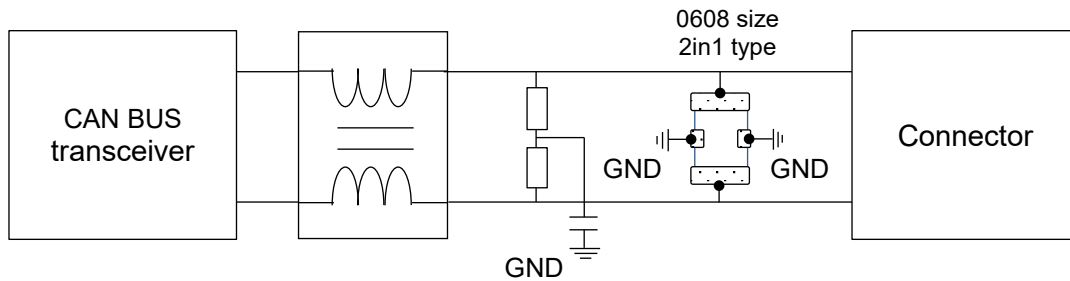

- Securing high quality signal by minimizing characteristic difference between high and low lines by 2in1 type original design (Necessity to comply with S-parameter frequency characteristic requirement)
- High destruction limit performance and excellent BCI test withstanding compared to TVS diode
- Reducing footprint and number of parts by 2in1 design

Ratings and characteristics

Size (inch)	Part No.	Maximum allowable voltage DC (V)	Nominal varistor voltage at 1 mA (V)	Capacitance (pF) at 1 MHz	Capacitance difference (pF) at 1 MHz	Maximum peak current at 8/20 μs, 2 times (A)	Clamping voltage at 8/20 μs (V)	Maximum ESD	
								IEC61000-4-2 150 pF/ 330 Ω	ISO10605 330 pF/ 2k Ω
0603	EZJPRV270RM	18	27 (24.3 to 32.4)	15.0 ± 3.0	1.0 max.	1	60 max. (1A)	Contact discharge 25 kV	Contact discharge 25 kV

● Operating temperature range : -55 to 150 °C

* Recommend soldering method : Reflow soldering

[Terms]

Maximum allowable voltage	Maximum DC Voltage that can be applied continuously within the operating temperature range
Varistor voltage	Varistor starting voltage between terminals at DC 1 mA, also known as Breakdown voltage
Capacitance	Capacitance value between each terminal and ground terminal at measurement frequency 1MHz and measurement voltage 1.0Vrms
Capacitance difference	Absolute value of the difference of the capacitance between the channels at measurement frequency 1MHz and measurement voltage 1.0Vrms
Maximum peak current	Maximum current that can be withstood under the standard pulse 8/20 μs, 2 times based
Clamping voltage	The maximum voltage between two terminals with the specified impulse current (8/20 μs)
Maximum ESD	Maximum voltage that can be withstood under ESD

Multilayer Varistors (Automotive grade) EZJZ-M, EZJP-M series / Characteristics

Varistor characteristics and equivalent circuit

A Multilayer Varistor does not have an electrical polarity like Zener diodes and is equivalent to total 3 pcs of 2 zener Z

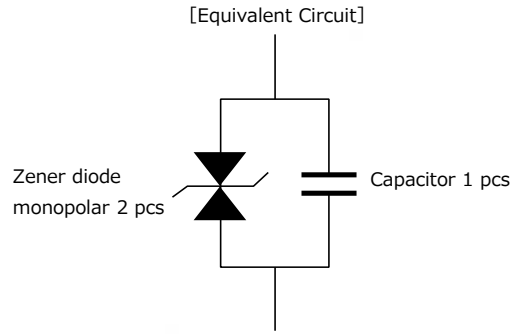
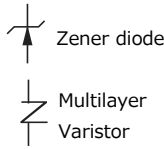
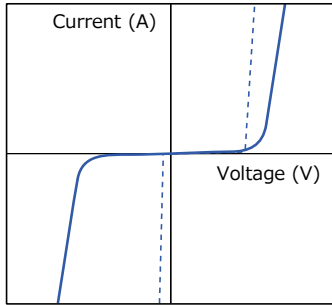

ESD Suppressive effects

Typical effects of ESD suppression

Test conditions :

IEC61000-4-2* Level 4 Contact discharge, 8 kV

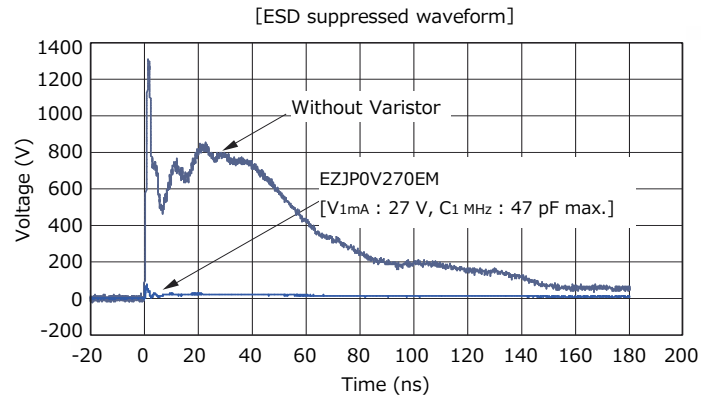
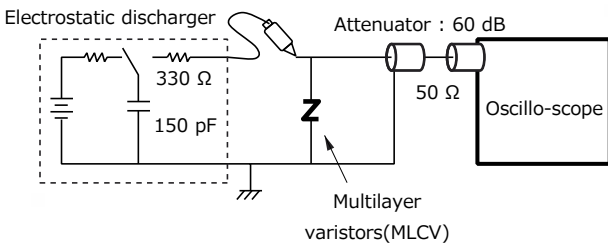

*IEC61000-4-2 ... International Standard of the ESD testing method (HBM) for electronic equipment ability to withstand ESD generated from a human body. It sets 4 levels of severity

Severity	Level 1	Level 2	Level 3	Level 4
Contact discharge	2 kV	4 kV	6 kV	8 kV
Air discharge	2 kV	4 kV	8 kV	15 kV

Replacement of Zener diode

Replacing "Zener diode and Capacitor" with Multilayer Varistor saves both the mounting area and number of components used.

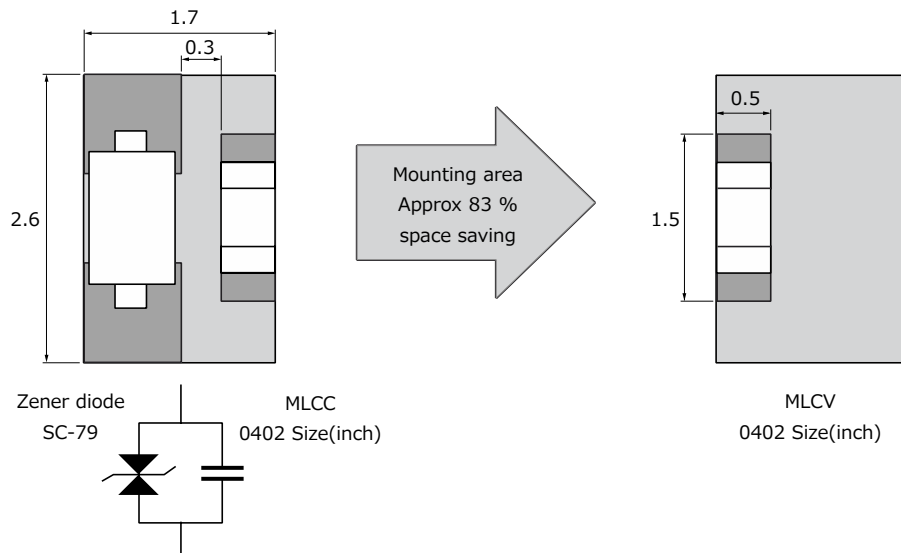

Unit : mm

Multilayer Varistors (Automotive grade) EZJZ-M, EZJP-M series / Performance and testing

Performance and testing methods

Characteristics	Specifications	Testing method
Standard test conditions		Electrical characteristics shall be measured under the following conditions. Temp. : 5 to 35 °C, Relative humidity : 85 % or less
Varistor voltage	To meet the specified value.	The Varistor voltage is the voltage (V_C , or V_{cmA}) between both end terminals of a Varistor when specified current (CmA) is applied to it. The measurement shall be made as quickly as possible to avoid heating effects.
Maximum allowable voltage	To meet the specified value.	The maximum DC voltage that can be applied continuously to a varistor.
Capacitance	To meet the specified value.	Capacitance shall be measured at the specified frequency, bias voltage 0 V, and measuring voltage 0.2 to 2.0 Vrms
Capacitance difference	To meet the specified value.	Capacitance shall be measured at the specified frequency, bias voltage 0 V, and measuring voltage 0.2 to 2.0 Vrms
Maximum peak current	To meet the specified value.	The maximum current measured (Varistor voltage tolerance is within $\pm 10\%$) when a standard impulse current of 8/20 μ seconds is applied twice with an interval of 5 minutes.
Maximum ESD	To meet the specified value.	The maximum ESD measured (while the varistor voltage is within blow ranges of its nominal value) when exposed to ESD 10 times (five times for each positive-negative polarity) based on IEC61000-4-2, ISO10605. EZJP□□□□□□M : within $\pm 10\%$, EZJZ□□□□□□M : within $\pm 30\%$
Solder ability	To meet the specified value.	<p>■ The part shall be immersed into a soldering bath under the conditions below.</p> <p>(1) Except EZJPR-M 2in1 type Solder : Sn-3.0Ag-0.5Cu Preheating : 140 to 180 °C, 60 to 120 sec Temp. rising : Preheating temp. to Peak temp., 2 to 5 °C/sec Heating : 220 °C min., 60 sec max. Peak temp. : 260 °C max, 10 sec max. Gradual cooling : Peak temp. to 140 °C, 1 to 4 °C/sec</p> <p>(2) EZJPR-M 2in1 type Solder : Sn-3.0Ag-0.5Cu Preheating : 150 to 200 °C, 60 to 120 sec Temp. rising : Preheating temp. to Peak temp., 3 °C/sec max. Heating : 217 °C min., 60 to 150 sec Peak temp. : 260 °C max. Gradual cooling : Peak temp. to 217 °C, 6 °C/sec max.</p>
Resistance to soldering heat	$\Delta V_C/V_C$: within $\pm 10\%$	<p>■ The part shall be immersed into a soldering bath under the conditions below.</p> <p>(1) Except EZJPR-M 2in1 type After the immersion into a soldering bath, leave the part for 24 ± 2 hours under the standard condition, then evaluate its characteristics. Soldering conditions are specified below: Soldering conditions : 270 ± 5 °C, 3.0 ± 0.5 s Soldering position : Immerse both terminal electrodes until they are completely into the soldering bath.</p> <p>(2) EZJPR-M 2in1 type After the reflow soldering, leave the part for 24 ± 2 hours under the standard condition, then evaluate its characteristics. Soldering conditions are specified below: Solder : Sn-3.0Ag-0.5Cu Number of reflow : 3 times Preheating : 150 to 200 °C, 60 to 120 sec Temp. rising : Preheating temp. to Peak temp., 3 °C/sec max. Heating : 217 °C min., 60 to 150 sec Peak temp. : 260 °C max. Gradual cooling : Peak temp. to 217 °C, 6 °C/sec max.</p>

Multilayer Varistors (Automotive grade) EZJZ-M, EZJP-M series / Performance and testing

Performance and testing methods

Characteristics	Specifications	Testing method															
Temperature cycling	$\Delta V_c/V_c$: within ± 10 %	<p>After repeating the cycles stated below for specified number of times, leave the part for 24 ± 2 hours, then evaluate its characteristics.</p> <p>Cycle : 2000 cycles</p> <table border="1"> <thead> <tr> <th>Step</th> <th>Temperature</th> <th>Period</th> </tr> </thead> <tbody> <tr> <td>1</td> <td>Max. operating temp.</td> <td>30 ± 3 min</td> </tr> <tr> <td>2</td> <td>Ordinary temp.</td> <td>3 min max.</td> </tr> <tr> <td>3</td> <td>Min. operating temp.</td> <td>30 ± 3 min</td> </tr> <tr> <td>4</td> <td>Ordinary temp.</td> <td>3 min max.</td> </tr> </tbody> </table>	Step	Temperature	Period	1	Max. operating temp.	30 ± 3 min	2	Ordinary temp.	3 min max.	3	Min. operating temp.	30 ± 3 min	4	Ordinary temp.	3 min max.
Step	Temperature	Period															
1	Max. operating temp.	30 ± 3 min															
2	Ordinary temp.	3 min max.															
3	Min. operating temp.	30 ± 3 min															
4	Ordinary temp.	3 min max.															
Vibration	$\Delta V_c/V_c$: within ± 10 %	<p>The varistor shall be soldered on the testing board shown.</p> <p>G force : 5 G</p> <p>Vibration frequency range : 10 to 2000 Hz</p> <p>Sweet time : 20 min.</p> <p>Sweet direction : 12 cycles for 3 courses perpendicular each other</p>															
Mechanical shock	$\Delta V_c/V_c$: within ± 10 %	<p>The varistor shall be soldered on the testing board shown.</p> <p>Shock-wave formation : Half sine , 11 ms</p> <p>G force : 50 G</p> <p>Sweet direction : 6 directions of X, Y, Z, for each three times</p>															
Biased humidity	$\Delta V_c/V_c$: within ± 10 %	<p>After conducting the test under the conditions specified below, leave the part 24 ± 2 hours, then evaluate its characteristics.</p> <p>Temperature : 85 ± 2 °C</p> <p>Humidity : 80 to 85 %RH</p> <p>Applied voltage : Maximum allowable voltage (Individually specified)</p> <p>Period : $2000 + 24/0$ h</p>															
High temperature exposure (dry heat)	$\Delta V_c/V_c$: within ± 10 %	<p>After conducting the test under the conditions specified below, leave the part 24 ± 2 hours, then evaluate its characteristics.</p> <p>Temperature : Maximum operating temperature ± 3 °C (Individually specified)</p> <p>Applied voltage : Maximum allowable voltage (Individually specified)</p> <p>Period : $2000 + 24/0$ h</p>															

Multilayer Varistors (Automotive grade) EZJZ-M, EZJP-M series / Packaging

Packaging methods (Taping)

● Standard quantity

Series	Size code (inch size)	Thickness (mm)	Kind of taping	Pitch (mm)	Quantity (pcs/reel)
EZJZ, EZJP	0 (0402)	0.5	Punched carrier taping	2	10,000
	1 (0603)	0.8		4	4,000
		0.7 max.		5,000	
	2 (0805)	1.25	Embossed carrier tape		2,000

● 2 mm Pitch (Punched carrier taping) Size 0402

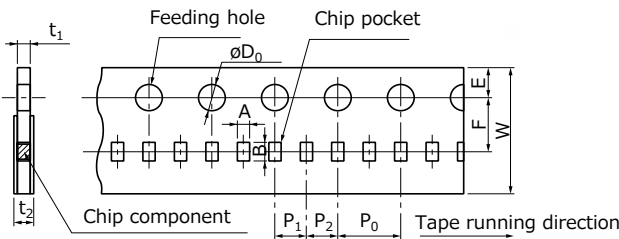

● 4 mm Pitch (Punched carrier taping) Size 0603

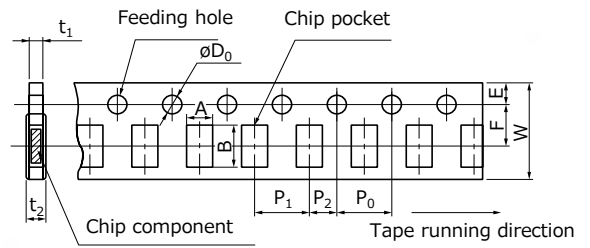

Unit : mm

Code	A	B	W	F	E	P ₁	P ₂	P ₀	øD ₀	t ₁	t ₂
EZJZ	0.62	1.12	8.0	3.50	1.75	2.00	2.00	4.0	1.5	0.7	1.0
EZJP	±0.05	±0.05	±0.2	±0.05	±0.10	±0.05	±0.05	±0.1	+0.1 0	max.	max.

Unit : mm

Code	A	B ¹	W	F	E	P ₁	P ₂	P ₀	øD ₀	t ₁	t ₂ ²
EZJZ	1.0	1.8	8.0	3.50	1.75	4.0	2.00	4.0	1.5	1.1	1.4
EZJP	±0.1	±0.1	±0.2	±0.05	±0.10	±0.1	±0.05	±0.1	+0.1 0	max.	max.

*1 : 1.77 ± 0.1 for 5,000 pcs/reel

*2 : 1.3 max. for 5,000 pcs/reel

● 4 mm Pitch (Embossed carrier tape) Size 0805

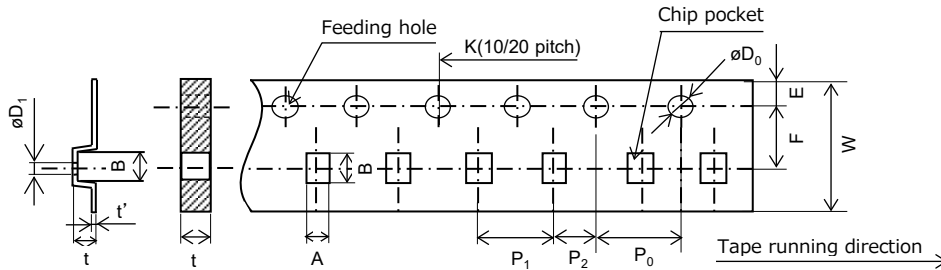

Unit : mm

Code	A	B	W	F	E	P ₁	P ₂	P ₀	øD ₀	t	t'	K
EZJZ	1.45	2.25	8.0	3.50	1.75	4.0	2.00	4.0	1.5	1.42	0.25	40.0
EZJP	±0.1	±0.1	±0.2	±0.05	±0.10	±0.1	±0.05	±0.1	+0.1 0	±0.1	±0.05	+0.15/ 10 pitch

● Reel for taping

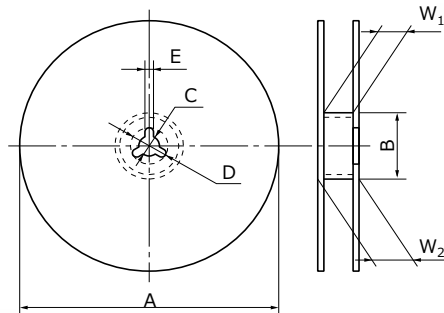

Unit : mm

Code	A	B	C	D	E	W ₁	W ₂
EZJZ	ø180	ø60.0	13.0	21.0	2.0	9.0	11.4
EZJP	0 -3	+1.0 0	±0.5	±0.8	±0.5	+1.0 0	±1.0

● Leader part and taped end

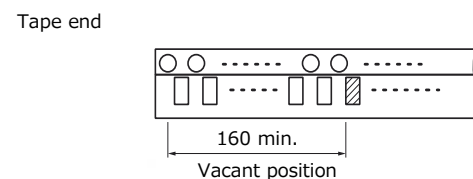
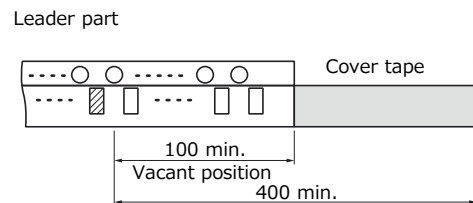

Unit : mm

■ As for packaging methods, handling precautions please see data files

Safety and Legal Matters to Be Observed

Product specifications and applications

- Please be advised that this product and product specifications are subject to change without notice for improvement purposes. Therefore, please request and confirm the latest delivery specifications that explain the specifications in detail before the final design, or purchase or use of the product, regardless of the application. In addition, do not use this product in any way that deviates from the contents of the company's delivery specifications.
- Unless otherwise specified in this catalog or the product specifications, this product is intended for use in general electronic equipment (AV products, home appliances, commercial equipment, office equipment, information and communication equipment, etc.).
When this product is used for the following special cases, the specification document suited to each application shall be signed/sealed (with Panasonic Industry and the user) in advance..These include applications requiring special quality and reliability, wherein their failures or malfunctions may directly threaten human life or cause harm to the human body (e.g.: space/aircraft equipment, transportation/traffic equipment, combustion equipment, medical equipment, disaster prevention/crime prevention equipment, safety equipment, etc.).

Safety design and product evaluation

- Please ensure safety through protection circuits, redundant circuits, etc., in the customer's system design so that a defect in our company's product will not endanger human life or cause other serious damage.
- This catalog shows the quality and performance of individual parts. The durability of parts varies depending on the usage environment and conditions. Therefore, please ensure to evaluate and confirm the state of each part after it has been mounted in your product in the actual operating environment before use.
If you have any doubts about the safety of this product, then please notify us immediately, and be sure to conduct a technical review including the above protection circuits and redundant circuits at your company.

Laws / Regulations / Intellectual property

- The transportation of dangerous goods as designated by UN numbers, UN classifications, etc., does not apply to this product. In addition, when exporting products, product specifications, and technical information described in this catalog, please comply with the laws and regulations of the countries to which the products are exported, especially those concerning security export control.
- Each model of this product complies with the RoHS Directive (Restriction of the use of hazardous substances in electrical and electronic equipment) (2011/65/EU and (EU) 2015/863). The date of compliance with the RoHS Directive and REACH Regulation varies depending on the product model.
Further, if you are using product models in stock and are not sure whether or not they comply with the RoHS Directive or REACH Regulation, please contact us by selecting "Sales Inquiry" from the inquiry form.
- During the manufacturing process of this product and any of its components and materials to be used, Panasonic Industry does not intentionally use ozone-depleting substances stipulated in the Montreal Protocol and specific bromine-based flame retardants such as PBBs (Poly-Brominated Biphenyls) / PBDEs (Poly-Brominated Diphenyl Ethers). In addition, the materials used in this product are all listed as existing chemical substances based on the Act on the Regulation of Manufacture and Evaluation of Chemical Substances.
- With regard to the disposal of this product, please confirm the disposal method in each country and region where it is incorporated into your company's product and used.
- The technical information contained in this catalog is intended to show only typical operation and application circuit examples of this product. This catalog does not guarantee that such information does not infringe upon the intellectual property rights of Panasonic Industry or any third party, nor imply that the license of such rights has been granted.
- Design, materials, or process related to technical owned by Panasonic Industry are subject to change without notice.

Panasonic Industry will assume no liability whatsoever if the use of our company's products deviates from the contents of this catalog or does not comply with the precautions. Please be advised of these restrictions.

Matters to Be Observed When Using This Product

(Chip-type laminated varistor : Automotive grade)

Safety measures

- An in-vehicle chip-type laminated varistor (hereinafter “the product” or “the varistor”) is intended for use in general-purpose and standard applications, such as electrostatic control/noise suppression in in-vehicle equipment. The varistor may deteriorate in performance or fail (short or open mode) when used improperly.
- If the varistor in short mode is used, applied voltage may cause a large current to flow through the varistor. Consequently, the varistor heats up and may burn the circuit board. An abnormal state of the varistor that results from a problem with its service conditions (use environment, design conditions, mounting conditions, etc.) may lead to, in a worst case scenario, burnout of the circuit board, serious accident, etc. Sufficiently check for what is described below before using the varistor.

Use environments and cleaning conditions

- This product (varistor) is not designed for use in the specific environments described below. Using the product in such specific environments or service conditions, therefore, may affect the performance of the product. Please check the performance and reliability of the product first and then use the product.
 - (1) Used in liquid, such as water, oil, chemicals, and organic solvents.
 - (2) Used in a place exposed to direct sunlight, an outdoor place with no shielding, or a dusty place.
 - (3) Used in a place where the product is heavily exposed to sea breeze or a corrosive gas, such as Cl₂, H₂S, NH₃, SO₂, or NO_x.
 - (4) Used in an environment where electromagnetic waves and radiation are strong.
 - (5) Located close to a heating component or a flammable material, such as a vinyl cable.
 - (6) Sealed or coated with a resin, etc.
 - (7) Solder flux of the soldered product is cleansed with a solvent, water, and a water-soluble cleaner (be careful with solder flux soluble to water).
 - (8) Used in a place where dew concentrates on the product.
 - (9) Used in a contaminated state. (Example) Touching a varistor (with uncovered skin) mounted on a printed board leaves sebum on the varistor. Do not handle the varistor in this manner.
 - (10) Used in a place where excessive vibration or impact is applied to the product.
- Use the varistor within the range of its specified ratings/capabilities. Using the varistor under severe service conditions that are beyond the specified ratings/capabilities causes degraded performance or destruction of the varistor, which may lead to scattering of varistor fragments, smoke generation, ignition, etc. Do not use the varistor at a working temperature or maximum allowable circuit voltage that exceeds the specified working temperature or maximum allowable circuit voltage. Do not locate the varistor close to combustible materials.
- In an improper cleaning solution, with which the varistor is cleaned, flux residues or other foreign matter may stick to the surface of the varistor, which degrades the performance (insulation resistance, etc.) of the varistor. In a polluted cleaning solution, the concentration of free halogen, etc., is high, and may result in poor/insufficient cleaning.
- Improper cleaning conditions (insufficient cleaning or excessive cleaning) may impair the performance of the varistor.
 - (1) Insufficient cleaning
 - (a) A halogenous substance in flux residues may corrode a metal element, such as a terminal electrode.
 - (b) A halogenous substance in flux residues may stick to the surface of the varistor and lower its insulation resistance.
 - (c) Tendencies described in (a) and (b) may be more notable with water-soluble flux than with rosin-based flux.Be careful about insufficient cleaning.
 - (2) Excessive cleaning

Ultrasonic waves that are too powerful from an ultrasonic cleaner cause the board to resonate, in which case the vibration of the board may cause the varistor or a soldered part to crack or reduce the strength of the terminal electrode. Keep power output from the ultrasonic cleaner at 20 W/L or lower, its ultrasonic frequency at 40 kHz or lower, and an ultrasonic cleaning time at 5 minutes or less.

Response to anomalies and handling conditions

- Do not apply excessive mechanical impact to the varistor. Because the varistor body is made of ceramic, drop impact to the varistor readily damages or cracks the varistor. Once dropped on the floor, etc., the varistor may have lost its sound quality and become failure-prone. Do not use said varistor.
- When handling the board carrying the varistor, be careful not to let the varistor hit against another board. Take extra caution when handling or storing a stack of boards carrying varistors. There are cases where a corner of a board will hit against a varistor and damage or crack it, which may result in a failure of the varistor, such as a drop in its insulation resistance. Do not reuse a varistor that has been used on and removed from a board.

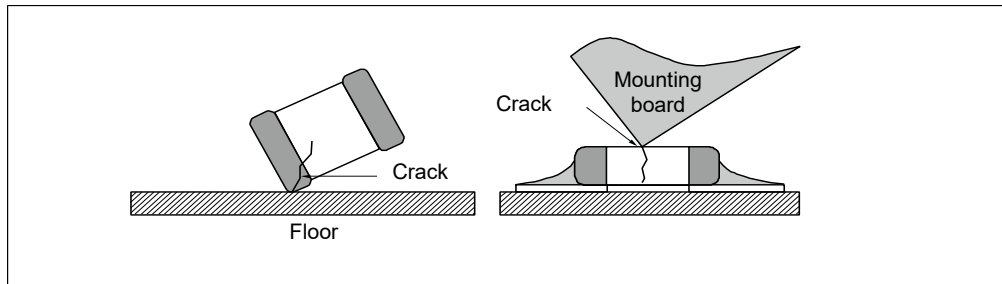

Reliability

To know the detailed specifications of individual products or specific evaluation test scores, please contact us. We issue a delivery specification sheet for each product ordered. Please confirm with the sheet when you place an order with us.

Circuit design and circuit board design

- A working temperature at which a varistor works in the circuit must be within the working temperature range specified in the specification sheet. A temperature at which a varistor incorporated in the circuit is kept in storage without operating must be within the storage temperature range specified in the specification sheet. Do not use the varistor at a higher temperature than the maximum working temperature.
- Keep voltage applied across the terminals of the varistor equal to or lower than the maximum allowable circuit voltage. Applying improper voltage to the terminals may cause the varistor to fail or short-circuit thus generate heat. When using the varistor in a circuit where high-frequency voltage or pulse voltage of an acute waveform is applied consecutively, even if the applied voltage is lower than the rated voltage, confirm that the varistor is reliable enough to operate normally in the circuit.
- Ensure that the surface temperature of the varistor, which includes a temperature increment resulting from self-heating, is equal to or lower than the highest working temperature specified in the delivery specification sheet. Check the temperature of the varistor under the circuit conditions used in the operation state of the device in which the varistor is incorporated.
- Using the varistor on an alumina board has an expectation of performance degradation due to thermal impact (temperature cycle). Before using the varistor, sufficiently confirm that the board does not affect the quality of the varistor.

Mounting conditions

- The more solder deposited on the varistor, the greater the stress to the varistor, which leads to cracking of the varistor. When designing a land on the board, determine the shape and dimensions of the land so that a proper volume of solder is applied in the land. Design the land such that its left and right sides are equal in size. In a case where solder volumes are different between the left and right sides of the land, a greater volume of solder takes more time to cool and solidify. As a result, stress acts on one side which may crack the varistor.

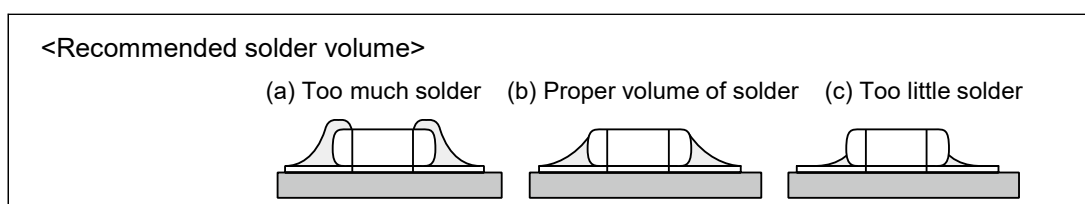

<Recommended land dimensions (example)>

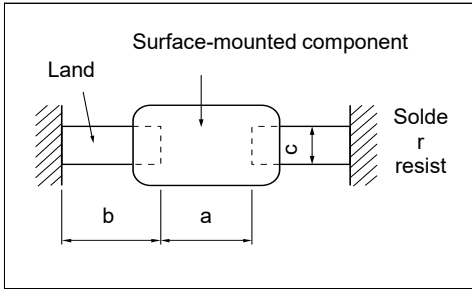

Shape symbol (Inch size)	Component dimensions			a	b	c
	L	W	T			
0 (0402)	1.0	0.5	0.5	0.4 to 0.5	0.4 to 0.5	0.4 to 0.5
1 (0608)	1.6	0.8	0.8	0.8 to 1.0	0.6 to 0.8	0.6 to 0.8
2 (0805)	2.0	1.25	1.25	0.8 to 1.2	0.6 to 1.0	0.6 to 1.0

Unit: mm

[EZJPR-M 2in1 type]

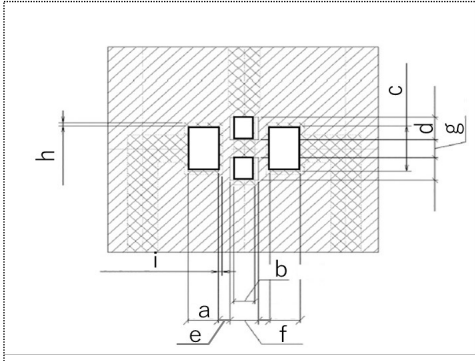

Shape symbol (Inch size)	Component dimensions			a	b	c
	L	W	T			
1 (0603)	1.6	0.8	0.7 max.	0.57 to 0.63	0.37 to 0.43	0.97 to 1.03
	d	e	f	g	h	i
	0.47 to 0.53	0.195 to 0.255	0.52 to 0.58	0.37 to 0.43	(0.075)	(0.075)

Unit: mm

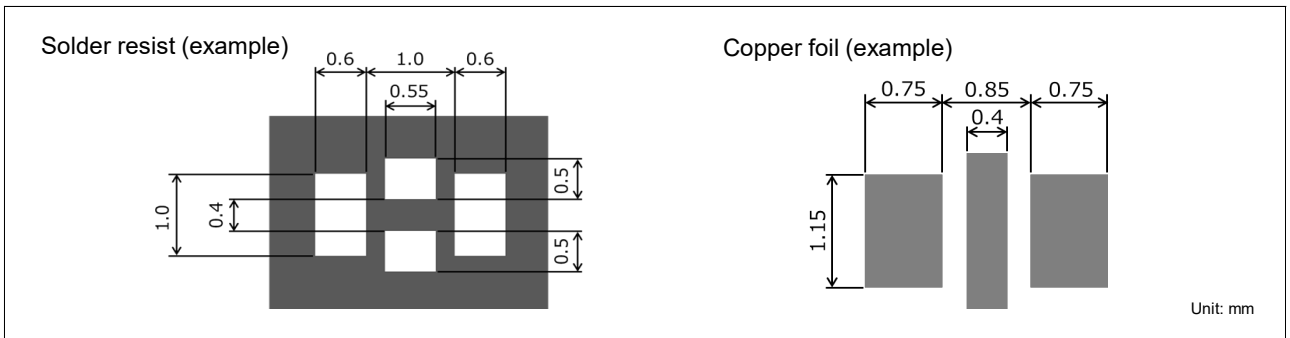

Unit: mm

<Using solder resist>

- Use solder resist to evenly distribute solder volumes on the left and right sides.
- When a component is located close to the varistor, the varistor is mounted together with a lead-attached component, or a chassis is located close to the varistor, separate solder patterns from each other using the solder resist.

* Refer to cases to avoid and recommended examples shown on the right table.

Items	Case to avoid	Case recommended
		(Example of improving soldering by separating solder patterns)
Mounting the varistor together with a lead-attached component	Lead of a lead-attached component 	Solder resist
Soldering in the vicinity of the chassis	Chassis Solder (earth solder) Electrode pattern 	Solder resist
Soldering a lead-attached component later	Lead of a component mounted later Solder iron 	Solder resist
Placing the products side by side	Part where too much solder is applied Land 	Solder resist

<Varistor placement that avoids stress caused by warp in the board>

- When the board warps during or after soldering of the varistor to the board, the warping of the board may cause the varistor to crack. Place the varistor so that stress caused by the warp is negligible to the varistor.

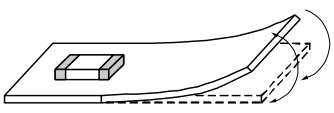
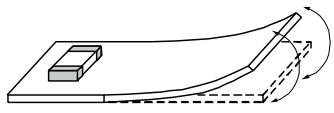
Case to avoid	Case recommended
	 Set the varistor sideways relative to the direction in which stress acts.

* Refer to the case to avoid and a case recommended example shown on the right table.

<Mechanical stress near a breaking line of the board>

- Mechanical stresses to the varistor near a breaking line of the board vary depending on the mounting position of the varistor. Refer to the figure on the right.
- The varistor receives mechanical stresses different in size when the board is broken by different methods. The size of the stress the varistor receives is smaller in the following order: pushing back<breaking along a slit<breaking along a V groove<breaking along a perforated line. In addition to varistor placement, consider the board breaking method as well.

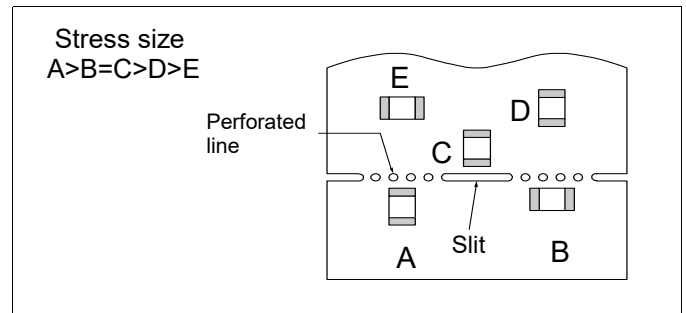

<Mounting density and space between components>

- When space between components is too narrow, solder bridges or solder balls have negative effects on the components. Be careful to provide proper space between the components.

<Mounting on the board>

- When the varistor is mounted on the board, an excessive impact load, such as pressure from a suction nozzle for mounting the varistor and mechanical impact/stress caused by a positional shift or positioning, may be applied to the varistor. Prevent application of such an excessive impact load to the varistor.
- A mounter needs to be checked and maintained regularly.
- When the bottom dead center of the suction nozzle is too low, an excessively large force is applied to the varistor when it is mounted, which may crack the varistor. Heed the following instructions when using the suction nozzle.
 - Set the bottom dead center of the suction nozzle at the upper surface of the straightened board.
 - Set the pressure of the suction nozzle equal to a static load between 1 N to 3 N.
 - In the case of double-face mounting, put a backup pin on the lower surface (back) of the board to prevent the board from warping. This keeps the impact of the suction nozzle as small as possible. Typical examples of using the backup pin are shown in the following table.

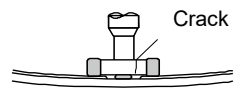
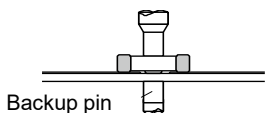
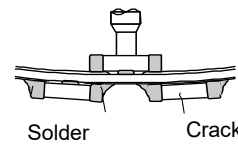
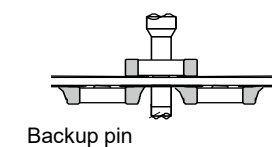
Items	Case to avoid	Case recommended
Single-face mounting	 Crack	The backup pin does not always need to be underneath the varistor.  Backup pin
Double-face mounting	 Solder separation Crack	 Backup pin

(4) Adjust the suction nozzle so that its bottom dead center is not too low.

- When positioning grippers wear out, they apply mechanical impact to part of the varistor when positioning it, thus chipping or cracking the varistor in some cases. Maintain the proper dimensions of the positioning grippers in their closed state and regularly carry out maintenance, check, or replacement of the positioning grippers.
- A varistor mounted on a heavily warped printed board, may crack or break. Put a backup pin on the back of the board to reduce the warp of the board to 0.5 mm or less with 90 mm span width.

<Selecting flux>

- Flux may have a great effect on the performance of the varistor. Before using the varistor, check whether the flux has any effect on the performance of the varistor.

<Soldering>

- Flow soldering (Except EZJPR-M 2in1 type)

In the flow soldering process, stress created by a sharp temperature change is applied directly to the varistor. Be careful, particularly, in controlling the solder temperature. The varistor is particularly vulnerable to rapid heating and rapid cooling. When heated or cooled rapidly, the varistor develops excessive heat stress therein resulting from the large temperature difference and because of this heat stress, may thermally crack. Observe the following instructions on preheating, gradual cooling, etc.

- (1) Applying flux : Apply a thin and uniform film of flux to the varistor. In the flow soldering process, flux application by a foaming method is generally adopted.
- (2) Preheating : Preheat the varistor sufficiently so that the difference between the solder temperature and the surface temperature of the varistor is 150 °C or less.
- (3) Immersion in solder : Immerse the varistor in melted solder of 240 °C to 260 °C in a solder bath for 3 to 5 seconds.
- (4) Gradual cooling : Avoid rapidly cooling (forced cooling) the soldered varistor, instead cool it gradually. Rapidly cooling the varistor may result in thermal cracking of the varistor.
- (5) Cleaning : When dipping the varistor in a cleaning solution right after soldering the varistor, confirm that the surface temperature of the varistor is 100 °C or lower.
- (6) There is no problem with one cycle of flow soldering under the recommended flow soldering profile (example) conditions shown in the following diagram.

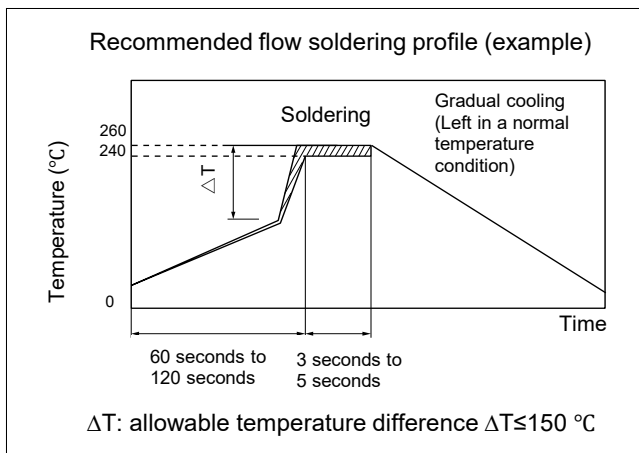

Size	Allowable temperature difference
0402, 0603, 0805	$\Delta T \leq 150 \text{ }^\circ\text{C}$

* Avoid flow soldering varistors whose specifications are defined separately.

- Reflow soldering

A temperature condition under which reflow soldering is performed is represented by a temperature curve consisting of a preheating part, a temperature-rising part, a main heating part, and a gradual cooling part. Heating the varistor rapidly creates excessive heat stress therein due to a large temperature difference and, because of this heat stress, the varistor may thermally crack. Be sufficiently careful with a temperature difference resulting from rapid heating. The preheating part is a temperature area that is important for preventing a tombstone (chip rising) phenomenon. Be sufficiently careful with temperature control.

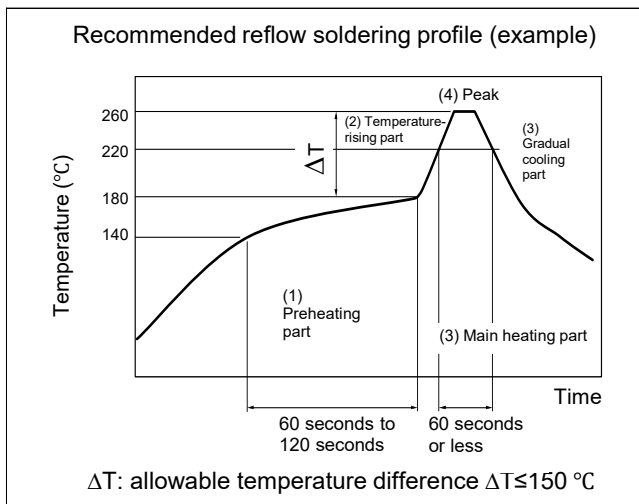

*Except EZJPR-M 2in1 type

Items	Temperature condition	Time, heating rate
(1) Preheating part	140 °C to 180 °C	60 to 120 seconds
(2) Temperature-rising part	Preheating temperature to peak temperature	2 to 5 °C per second
(3) Main heating part	220 or higher	60 seconds or less
(4) Peak	260 or less	10 seconds or less
(5) Gradual cooling part	Peak temperature to 140 °C	1 to 4 °C per second

Size	Allowable temperature difference
0402, 0603, 0805	$\Delta T \leq 150 \text{ }^\circ\text{C}$

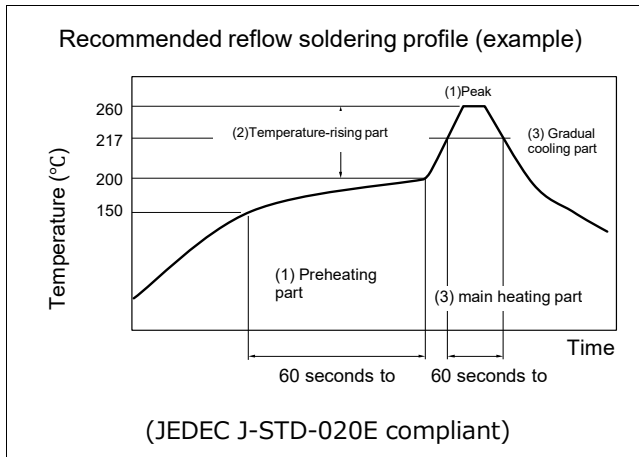

EZJPR-M 2in1 type

Items	Temperature condition	Time, heating rate
(1) Preheating part	150 °C to 200 °C	60 to 120 seconds
(2) Temperature-rising part	Preheating temperature to peak temperature	3 °C per second or less
(3) Main heating part	217 °C or higher	60 to 150 seconds
(4) Peak	260 °C or less	—
(5) Gradual cooling part	Peak temperature to 217 °C	6 °C per second or less

Avoid performing rapid cooling (forced cooling) during the gradual cooling part. Rapidly cooling the varistor may result in thermal cracking of the varistor. When dipping the varistor in the cleaning solution right after soldering the varistor, confirm that the surface temperature of the varistor is 100 °C or lower. There is no problem with two cycles of reflow soldering under the recommended reflow soldering profile (example) conditions shown in the above diagram. Be sufficiently careful with deflection or warping of the board.

Note that the recommended soldering conditions indicate conditions under which the degradation of the product characteristics does not occur but do not indicate conditions under which stable soldering can be performed. Check and set conditions under which stable soldering can be performed, on a case-by-case basis.

Varistor temperatures vary depending on the mounted state of the varistor. Make sure to confirm that the surface temperature of the varistor is within the specified temperature when the varistor is mounted and then use the varistor.

• Soldering-iron-used soldering

In soldering-iron soldering, stress created by a rapid temperature change is applied directly to the varistor. Be sufficiently careful in controlling the temperature of the soldering iron tip. Be careful not to let the soldering iron tip come in direct contact with the varistor or its terminal electrode.

The varistor is particularly vulnerable to rapid heating and rapid cooling. When heated or cooled rapidly, the varistor develops excessive heat stress therein resulting from the large temperature difference and because of this heat stress, may thermally crack. Observe the following instructions on preheating, gradual cooling, etc.

Once a varistor soldered with a soldering iron is removed from the board, it cannot be used again.

(1) Condition 1 (preheating included)

- (a) Solder: : Use wire solder (with less chloride content) that is meant for soldering precision electronic equipment. (Wire diameter: 1.0 mm or less)
- (b) Preheating: : Preheat the varistor sufficiently so that the difference between the solder temperature and the surface temperature of the varistor is 150°C or less.
- (c) Temperature of the soldering iron tip : 350°C or lower (a required volume of solder is melted on the soldering iron tip in advance).
- (d) Gradual cooling : After soldering the varistor, leave it in normal temperature conditions to let it cool gradually.

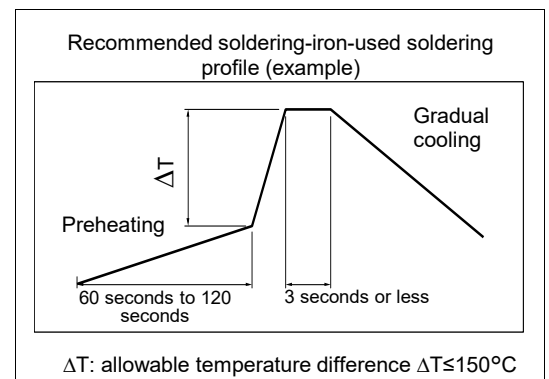

(2) Condition 2 (preheating not included)

If soldering iron tip conditions listed in the table on the right are met, the varistor can be soldered with the soldering iron without preheating the varistor.

- (a) Make sure that the soldering iron tip does not come in direct contact with the varistor or its terminal electrode.
- (b) After preheating the land sufficiently with the soldering-iron tip, slide the soldering-iron tip toward the terminal electrode of the varistor to solder the varistor.

Soldering iron tip conditions in soldering without preheating

Items	Condition
Temperature of the soldering iron tip	350 °C or lower
Wattage	20 W or less
Shape of the soldering iron tip	ø3 mm or less
Soldering-iron applying time	3 seconds or less

<Inspection>

- When the printed board is inspected with measurement terminal pins after the varistor is mounted on the board, the measurement terminal pins pressed against the printed board cause the board to warp, which may cause a crack to form on the varistor.
 - Put the backup pin on the back of the printed board to reduce the warp of the board to 0.5 mm or less with a 90 mm span width.
 - Check whether the shape of the front ends of the measurement terminal pins poses no problem, whether the pins are equal in length, whether the pressure of the pins are not excessively high, and whether the set position of the pins is correct.

Items	Case to avoid	Case recommended
Warp in the board		

<Protective coat>

- When the varistor is coated with or embedded in a resin to improve the varistor's resistance to humidity and gas or to set the varistor stationary, it is expected that the following problems will arise. In such cases, confirm the performance and reliability of the varistor in advance.
 - A solvent included in the resin infiltrates the varistor and impairs its characteristics.
 - Heat from chemical reaction (curing heat) generated by the resin when it cures exerts a negative effect on the varistor.
 - Expansion/shrinkage of the resin applies stress to the soldering part and causes it to crack.

<Splitting a multiple formation printed board>

- When splitting the board having components, including a mounted varistor into multiple pieces, be careful not to apply bending stress or torsional stress to the board. If bending stress or torsional stress, shown in the following diagram, is applied to the board when it is split, the varistor may develop a crack. Avoid, as much as possible, applying stress to the board.

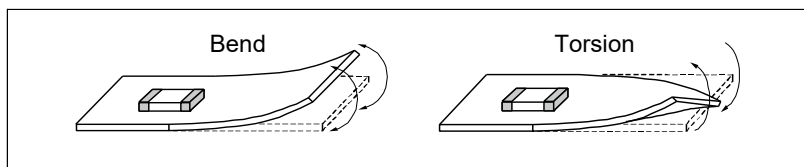

- Avoid manually splitting the board so as to keep mechanical stress to the board as small as possible. When splitting the board, use a splitting jig or a board splitter.
- Example of a board splitting jig
An example of a board splitting jig is shown in the following diagram. Holding the part of the board that is far from the jig and applying a load bend the board excessively. Holding the part of the board that is closer to the jig and applying a load allow you to split the board with less bending.

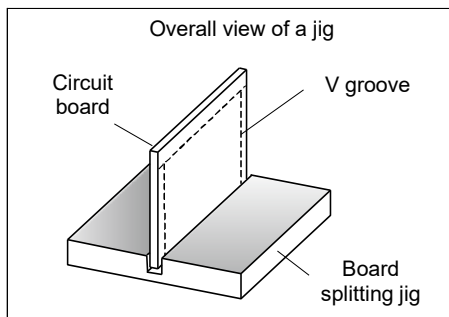

Case to avoid	Case recommended

Storage conditions

- Avoid a high-temperature/high-humidity storage place and keep the varistor in a storage place where temperature ranges from 5 °C to 40 °C and relative humidity ranges from 20% to 70%.
- Do not store the varistor in a place where moisture, dust, or corrosive gas (hydrogen chloride, hydrogen sulfide, sulfur dioxide, ammonia, etc.) is present. It may impair the solderability of the terminal electrode. Also, in places where the varistor package is exposed to heat, direct sunlight, etc., packaging tape may deform or stick to the varistor which causes a problem when the varistor is mounted. Be careful in such cases.
- A varistor storage period shall be 12 months or less. When using a varistor kept in storage for more than 12 months, confirm its solderability before using it.







Looking for pricing, stock, or lifecycle information?

Click below to explore more details on WIN SOURCE:

 [View EZJ-P1V650DM on WIN SOURCE](#)

 [Panasonic Information](#)

Optimize Your Supply Chain with WIN SOURCE Solutions

-  Global Sourcing Solution
-  Obsolete Management
-  Cost Control Management
-  Shortage Management
-  Alternative Solution
-  Excess Inventory Management